

Leader

20260701
Ver. 9

LT 4448 CHANGEOVER

Instruction Manual

Thank you for purchasing.

Please carefully read this instruction manual and the included "GENERAL SAFETY SUMMARY".
Please use the product safely.

TABLE OF CONTENTS

GENERAL SAFETY SUMMARY	I
1. INTRODUCTION	1
1.1 Scope of Warranty	1
1.2 Trademark Acknowledgments	1
1.3 Operating Precautions	2
1.3.1 Power Supply Voltage	2
1.3.2 Maximum Allowable Input Voltage	2
1.3.3 Mechanical Shock	2
1.3.4 Electrostatic Damage	2
1.3.5 Warming Up	2
2. SPECIFICATIONS	3
2.1 General	3
2.2 Features	3
2.3 Specifications	5
2.3.1 Compliant Standards	5
2.3.2 I/O Connectors	5
2.3.3 I/O Characteristics	6
2.3.4 Input Signals	7
2.3.5 Signal Switching	7
2.3.6 Fault Detection	8
2.3.7 Alarm Detection	9
2.3.8 Key Lock	9
2.3.9 External Control Connectors	10
2.3.10 General Specifications	11
3. PANEL DESCRIPTION	12
3.1 Front Panel	12
3.2 Rear Panel	13
3.3 Top Panel	14
4. HOW TO USE	15
4.1 Attaching Rack Supports	15
4.2 Connecting and Disconnecting the Power Cord	16
4.3 Turning the Power On	17
4.4 Turning the Power Off	17
4.5 DIP Switch Settings	18
4.5.1 Setting Method	20
4.5.2 Setting the channel 1 to 11 input signals	20
4.5.3 Setting the LTC Input Signal and Output Alarm Indication	22
4.5.4 Setting the Fault Detection Speed	23

4.5.5	Setting the Fault Detection Reference.....	25
4.5.6	Setting the Fault Detection Level (User-defined)	26
4.5.7	Setting the Operation Mode, Standby Time and Fault information	27
4.6	Ch1 to 11 Signal I/O.....	29
4.7	LTC Signal I/O	30
4.7.1	LTC Connection Cables (Sold Separately).....	31
4.8	LT 4448 Configuration	37
4.8.1	Setting the Key Lock	37
4.8.2	Switching the Output Signal	37
4.8.3	Setting Automatic Signal Switching	38
4.8.4	Switching the Control	40
4.9	LT 4448 Indications	41
4.9.1	Fault Indication.....	41
4.9.2	Alarm Indications.....	42
5.	REMOTE CONTROL	43
6.	ETHERNET CONTROL.....	45
6.1	SNMP Configuration Software	45
6.1.1	Installation.....	45
6.1.2	Uninstallation	48
6.1.3	Connection.....	49
6.1.4	Window Explanations	50
6.2	SNMP.....	52
6.2.1	SNMP Version.....	52
6.2.2	Control Items	52
6.2.3	SMI Definitions	52
6.2.4	Notes on Updating	52
6.2.5	HOW TO USE	53
6.2.6	Enterprise MIB	54
6.2.7	Extended TRAP (Variable Binding List).....	62
6.3	HTTP Server Feature	64
6.3.1	Operating Environment.....	64
6.3.2	Precautions	64
6.3.3	HOW TO USE	65

GENERAL SAFETY SUMMARY

■ Read This before Using the Instrument

This instrument should only be used by persons with sufficient knowledge of electronics who thoroughly understand the contents of this manual.



This instrument is not designed or manufactured for households or ordinary consumers. If unqualified personnel are to use the instrument, be sure the instrument is handled under the supervision of qualified personnel (those who have electrical knowledge). This is to prevent the possibility of personal injury or damage to the instrument.

■ Note about Reading This Manual

The contents of this manual contain specialized terminology and may be difficult to understand. If you have any questions about the contents of this manual, please contact your local LEADER agent.

■ Symbols and Terms

The following symbols and terms are used in this instruction manual and on the instrument to indicate important warnings and notes.

	<p>This symbol appears in this instruction manual and on the instrument to indicate an area where improper handling could result in personal injury, damage to the instrument, or malfunction of the instrument or devices connected to it.</p> <p>When you encounter this symbol on the instrument, be sure to refer to the information in this instruction manual that corresponds to the area that the symbol marks.</p>
	<p>Ignoring the precautions that this term indicates could lead to death or serious injury.</p>
	<p>Ignoring the precautions that this term indicates could lead to personal injury or damage to the instrument.</p>

GENERAL SAFETY SUMMARY

Read the warnings and information below thoroughly to avoid death, personal injury, and damage and deterioration of the instrument.



■ Warnings Concerning the Case and Panels

Do not remove the instrument's case or panels (except for DIP switch cover) for any reason except for setting DIP switches. Touching the internal components of the instrument could lead to fire or electric shock.

Also, do not allow foreign materials, such as liquids, combustible matter, and metal, to enter the instrument. Turning the instrument on when such materials are inside it could lead to fire, electric shock, damage to the instrument, or some other accident.

■ Installation Environment

● Operating Temperature Range

Use this instrument in a 0 to 40 °C environment. Using the instrument in a high temperature environment could lead to fire.

Drastic changes in temperature, such as might be caused by moving the instrument between two rooms with different temperatures, can damage the instrument by causing condensation to form within it. If there is a possibility that the instrument has condensation within it, wait for approximately 30 minutes before turning on the power.

● Operating Humidity Range

Use this instrument in an environment whose relative humidity is 90 %RH or less where there is no threat of condensation forming.

Also, do not operate this instrument with wet hands. Doing so could lead to electric shock or fire.

● Do Not Operate in an Explosive Atmosphere

Using this instrument in an environment where flammable gasses, explosive gasses, or steam is emitted or stored could lead to an explosion or fire. Do not use the instrument in such an environment.

● Do Not Insert Foreign Materials

Do not insert foreign materials, such as metal and flammable objects, through the vents or allow liquid to enter the instrument. Such acts can lead to fire, electric shock, damage to the instrument, or some other accident.

■ If You Notice Something Wrong during Operation

If you notice smoke, fire, a strange smell, or something else that is wrong with the instrument while you are operating it, stop operation immediately. Failing to do so could lead to fire. Remove the power cord from the outlet. After making sure that fire has not spread anywhere, contact your local LEADER agent.

GENERAL SAFETY SUMMARY



■ Warnings Concerning the Power Source

Do not use a power source with a voltage other than the rated power source voltage for the instrument. Doing so could lead to fire.

Confirm the voltage of the power source before you connect the power cord to it.

Only use a power source whose frequency is 50/60 Hz.

Use a power cord that is appropriate for the voltage of the power source. Also, use a power cord that meets the safety standards of the country that you are using it in.

Using a power cord that does not meet the standards could lead to fire. If the power cord is damaged, stop using it, and contact your local LEADER agent. Using a damaged power cord could lead to electrical shock or fire.

When removing the power cord from the power outlet, do not pull on the cord. Pull from the plug.

■ Warnings Concerning Grounding

The instrument has a ground terminal to protect the user and the instrument from electric shock. Ensure that the product is properly grounded for safe operation.

■ Warnings Concerning the Panel

Sections of the panel are made out of glass. If the glass breaks, the broken glass may lead to injury. Do not apply a strong shock to the panel, cut it with sharp metal, or damage it in any similar manner.



■ Cautions Concerning the Input and Output Connectors

To avoid damaging the instrument, only apply signals to the input connectors that conform to the specifications in this instruction manual. Do not short or apply external voltage to the output connectors. Doing so could damage the instrument.

■ If You Will Not Use the Instrument for an Extended Period of Time

If you will not use the instrument for an extended period of time, remove the power plug from the outlet.

■ Cautions Concerning the Ethernet Port

When you are connecting the instrument to the communication provider's equipment, connect to the Ethernet port through a hub that is authorized for use in the country that you are using the instrument in.

GENERAL SAFETY SUMMARY

■ Calibration and Repair

This instrument has been carefully examined at the factory to ensure that its performance is in accordance with the standards. However, because of factors such as parts wearing out over time, the performance of the instrument may degrade. To ensure stable performance, we recommend that you have the instrument calibrated regularly. Also, if the instrument malfunctions, repairs are necessary. For repairs and calibration, contact your local LEADER agent.

■ Routine Maintenance

When you clean the instrument, remove the power plug from the outlet.

Do not use thinner or benzene when you clean the instrument's case, panels, or knobs. Doing so could lead to paint chipping and the corrosion of plastic components. To clean the case, panels, and knobs, use a soft cloth with mild detergent, and wipe gently. While cleaning, make sure that foreign materials, such as water and detergent, do not enter the product. If liquid or a metal object enters into the instrument, fire or electric shock may result.

■ CE



This product complies with CE standards.

EMC Directive: 2014/30/EU EN 61326-1:2013

LOW VOLTAGE Directive: 2014/35/EU EN 61010-1:2010+A1:2019

RoHS Directive: 2011/65/EU (EU)2015/863 EN IEC 63000:2018

■ UKCA



This product complies with UKCA standards.

■ WEEE



This instrument is subject to the European WEEE Directive.

Follow the applicable regulations of your country or region when discarding this instrument. Follow the EU Battery Directive when discarding the batteries that you removed from this instrument.

(WEEE stands for Waste Electrical and Electronic Equipment.)

■ KC



This product complies with KC standards.

MSIP-REI-Ik3-022

Follow the warnings and precautions that have been listed in this section to use the instrument correctly and safely. Precautions are also contained in various other sections of this instruction manual. To use the instrument correctly, be sure to follow those precautions as well.

If you have any questions or comments about this instruction manual, please contact your local LEADER agent.

1. INTRODUCTION

Thank you for purchasing this LEADER instrument. To use this instrument safely, read this instruction manual thoroughly, and make sure that you know how to use the instrument properly.

If some point about the operation of this instrument is still unclear after you have read this instruction manual, refer to the contact information on the back cover of the manual to contact LEADER, or contact your local LEADER agent.

After you have finished reading this manual, keep it in a convenient place so that you can refer to it when necessary.

1.1 Scope of Warranty

This LEADER instrument has been manufactured under the strictest quality control guidelines. LEADER shall not be obligated to furnish the following free services during the warranty period.

1. Repair of malfunction or damages resulting from fire, natural calamity, or improper voltage applied by the user.
2. Repair of a product that has been improperly repaired, adjusted, or modified by personnel other than a factory-trained LEADER representative.
3. Repair of malfunctions or damages resulting from improper use.
4. Repair of malfunctions caused by devices other than this instrument.
5. Repair of malfunctions or damages without the presentation of a proof of purchase or receipt bill for the instrument.

1.2 Trademark Acknowledgments

The company and product names in this document are trademarks or registered trademarks of their respective holders.

1. INTRODUCTION

1.3 Operating Precautions

1.3.1 Power Supply Voltage



Confirm the voltage of the power source before you connect the power cord to it. The power requirements of this product are indicated on the rear panel. Only use a power source that supplies a voltage within the operating voltage range and has a frequency of 50/60 Hz.

1.3.2 Maximum Allowable Input Voltage



The maximum signal voltage that can be applied to the input connectors is indicated below. Do not apply excessive voltage to the connectors. Doing so may damage the device or lead to injury.

Table 1-1 Maximum allowable input voltage

Input Connector	Maximum Allowable Input Voltage
CHANNEL 1 and 2 (PRIMARY, BACKUP)	$\pm 5V$
CHANNEL 3 to 10 (PRIMARY, BACKUP)	$\pm 1.5V$
CHANNEL 11 (PRIMARY, BACKUP)	0V/+5V (TTL)
LTC (PRIMARY, BACKUP)	4Vp-p

1.3.3 Mechanical Shock

This instrument contains sensitive components, so it may be damaged if it is dropped or otherwise exposed to a strong shock.

1.3.4 Electrostatic Damage

Electronic components can be damaged by static discharge. Static electricity can build up in the core wire of a coaxial cable. Before connecting a coaxial cable to an I/O connector of the instrument, short the core wire of the cable with the external conductor.

1.3.5 Warming Up

To ensure more accurate measurements, turn ON the instrument approximately 30 minutes before you intend to use it to allow its internal temperature to stabilize.

2. SPECIFICATIONS

2.1 General

The LT 4448 is a changeover unit that automatically switches the signal from the primary signal to the backup signal when problems are detected in the primary signal. Two systems of input signals (primary and backup) are connected to the LT 4448, and the LT 4448 detects errors in the amplitude of the primary input signal.

A single LT 4448 has 11 BNC channels and 3 LTC channels. These channels can receive SDI, NTSC/PAL black burst, HD tri-level sync, AES/EBU digital audio, word-clock signals, and LTC signals. SDI signals are switched with relays; all other signals can be switched with electronic switches. The power supplies are redundant. Alarms are generated when errors occur.

The LT 4448 is used in combination with the LT4670 (SYNC GENERATOR), LT 4610 (SYNC GENERATOR), or LT 4600A (MULTIFORMAT VIDEO GENERATOR) at close distance.

2.2 Features

- I/O Connectors

A single LT 4448 is equipped with 11 sets of BNC I/O connectors and 3 sets of LTC I/O connectors.

A single set consists of a primary input connector, a backup input connector, and an output connector.

- Input Switching

Relays are used to switch between the primary signals and backup signals of channels 1 and 2.

High-speed electronic switches are used to switch between the primary signals and backup signals of channels 3 to 11 and LTC.

- Selecting the Input Signal

On channels 1 and 2, you can select SDI signals (3G, HD, SD), NTSC/PAL black burst signals, or HD tri-level sync signals.

On channels 3 to 8, you can select NTSC/PAL black burst signals or HD tri-level sync signals.

Channels 9 and 10 are exclusively for AES/EBU digital audio signals.

Channel 11 is exclusively for word-clock signals. It receives TTL signals.

LTC channels are dedicated to LTC signals. They are 2 Vp-p differential inputs.

- LTC Channels

LTC channels provide three systems of two inputs (primary and backup) and three systems of one output.

It can also connect to an LT 4610 (SYNC GENERATOR) or LT4670 (SYNC GENERATOR) with a dedicated cable (sold separately).

2. SPECIFICATIONS

- Fault Detection

When an input signal level error is detected, the LT 4448 lights the panel fault LED as well as the panel LED that indicates the channel that is causing the problem. This feature allows quick investigation of the problem.

Channels 3 to 11 are equipped with high-speed fault detection circuits. These enable the LT 4448 to switch to a backup signal with barely any disturbances shown on the screen when problems such as interruptions occur in the primary signal.

- Alarm Detection

If an error is detected at an output connector of channels 3 to 11, or power supply, a panel LED indicating where the error occurred lights to alert the user.

- Power Supply Start Time

A delay for starting the fault detection at power up can be set to none or approximately 1, 2, or 4 minutes depending on the rise time of the system signal source that the LT 4446/4447 is connected to.

- SNMP Ready

Error monitoring over an Ethernet network is possible. Traps are issued for error detection, panel control, and remote control. In addition, DIP switch settings (except for the user-defined fault detection level) can be changed or read as status information.

SNMP configuration software is available for IP address configuration. (Compatible with Windows 7 32 bit and 64 bit, Windows 8, and Windows 10)

- WEB Browser

The LT 4448 can be controlled with a Web browser.

- Combining with an LT4670, LT 4610, or LT 4600A

The depth of the LT 4448 is the same as that of the LT4670 (SYNC GENERATOR), LT 4610 (SYNC GENERATOR), or LT 4600A (MULTIFORMAT VIDEO GENERATOR). This makes it easy to wire and operate the devices when you combine them.

- Redundant Power Supply

Redundant power supply provides extra reliability. Alarms are generated when errors occur.

2. SPECIFICATIONS

2.3 Specifications

2.3.1 Compliant Standards

SDI Signal	
3G-SDI	SMPTE ST 372, SMPTE ST 424, SMPTE ST 425
HD-SDI (including HD dual link)	SMPTE ST 274, SMPTE ST 292, SMPTE ST 296
SD-SDI	SMPTE ST 125, SMPTE ST 259
Sync Signal	
NTSC Black Burst Signal	SMPTE ST 170, SMPTE ST 318, SMPTE RP 154
PAL Black Burst Signal	ITU-R BT.1700, EBU N14
HD Tri-Level Sync Signal	SMPTE ST 274, SMPTE ST 296
AES/EBU Digital Audio Signal	AES3, SMPTE ST 276
LTC Signal	SMPTE 12M-1

2.3.2 I/O Connectors

Primary Input Connectors	
Ch1 to 10	10 input connectors (75 Ω BNC connectors)
Ch11	1 input connector (TTL, 75 Ω BNC connector)
Backup Input Connectors	
Ch1 to 10	10 input connectors (75 Ω BNC connectors)
Ch11	1 input connector (TTL, 75 Ω BNC connector)
Output Connectors	
Ch1 to 10	10 output connectors (75 Ω BNC connectors)
Ch11	1 output connector (+5 V CMOS, 75 Ω BNC connector)
LTC Connectors	
Connector	25-pin D-sub (input and output shared)
Number of Inputs	3 systems each 2 inputs (PRIMARY, BACKUP)
Number of Outputs	3 systems 1 output (OUTPUT)

2. SPECIFICATIONS

2.3.3 I/O Characteristics

Ch1 and 2 (typical)

Return Loss	30 dB (0 to 10 MHz) 15 dB (10 MHz to 1.5 GHz) 10 dB (1.5 to 3 GHz)
Insertion Loss	0.2 dB (0 to 10 MHz) 0.5 dB (10 to 500 MHz) 2.0 dB (1.5 to 3 GHz)
Crosstalk	-60 dB (0 to 10 MHz) -48 dB (10 MHz to 1.5 GHz) -40 dB (1.5 to 3 GHz)
Impedance	External termination
Maximum Input Voltage	±5V

Ch3 to 10

Return Loss	30 dB (0 to 10 MHz, internally terminated)
Insertion Loss	0.3 dB (0 to 10 MHz)
Crosstalk	-55 dB (0 to 10 MHz) -45 dB (10 to 30 MHz)
Input Impedance	75Ω
Output Impedance	75Ω
Maximum Input Voltage	±1.5V

Ch11

Input Impedance	Approx. 4 kΩ
Output Impedance	Approx. 60 Ω
Maximum Input Voltage	0V/+5V (TTL)

LTC

Input Impedance	600 Ω balanced
Input Signal Level	0.5 to 4Vp-p
Output Impedance	600 Ω balanced
Output Signal Level	2Vp-p±10%
Number of input channels	LTC1, LTC2, LTC3 (3 channel inputs)
Number of output channels	LTC1, LTC2, LTC3 (3 channel outputs)

GPI (LTC connector shared)

LT4670 and LT 4610 alarm outputs

Number of Inputs	PRIMARY, BACKUP, 1 each
Number of Outputs	PRIMARY, BACKUP, 1 each
Output method	Through
Output Signal Level	5V CMOS

2. SPECIFICATIONS

2.3.4 Input Signals

Setting Method	Select the input signal type for each channel with DIP switches or external control.
Ch1 and 2	NTSC black burst signal PAL black burst signal HD tri-level sync signal SD-SDI signal (270 Mb/s) HD-SDI signal (1.485 Gb/s) 3G-SDI signal (2.97 Gb/s)
Ch3 to 8	NTSC black burst signal PAL black burst signal HD tri-level sync signal
Ch9 and 10	AES/EBU Digital Audio Signal
Ch11	Word-clock Signal (TTL)
LTC	LTC Signal

2.3.5 Signal Switching

Switching Method	
Ch1 and 2	Relays
Ch3 to 11, LTC	Electrical switches
Switch Time of the Relay (*1)	
Ch1 and 2	2 ms or less
High-speed Switch Time	
Ch3 to 11, LTC	100 ns or less
Switch Time due to Fault Detection	
Ch1, 2 and LTC	70 ms or less
Ch3 to 8	
High-Speed Detection	1.5 H or less
Low-Speed Detection	60 ms or less
Ch9 and 10	
High-Speed Detection	6 us or less
Low-Speed Detection	60 ms or less
Ch11	
High-Speed Detection	60 us or less
Low-Speed Detection	60 ms or less

*1 This is the time it takes for the signal to stabilize after the relay is switched.

2. SPECIFICATIONS

2.3.6 Fault Detection

Fault Indication	Indicates with LEDs the problematic signal system (PRIMARY or BACKUP) if a fault is detected
Fault Channel Indication	Indicates with LEDs the problematic channels when a fault is detected
DC Offset	±30 mV (sync signal only)
High-Speed Detection	Detects a fault when a signal drops out
Low-Speed Detection	Detects a fault when a signal level falls below the detection level
Detection Level	2 to 5 dB below the specified level
Detection Reference	
Ch1 to 11	Select LOW, HIGH, or user-defined level with DIP switches for each input signal type.
Low level (*1)	
NTSC Black Burst Signal	-180 to -227 mV (-286 mV)
PAL Black Burst Signal	-190 to -238 mV (-300 mV)
HD Tri-Level Sync Signal	337 to 476 mV (600 mV)
SD-SDI signal (270 Mb/s)	450 to 635 mV (800 mV)
HD-SDI signal (1.485 Gb/s)	450 to 635 mV (800 mV)
3G-SDI signal (2.97 Gb/s)	450 to 635 mV (800 mV)
AES/EBU Digital Audio Signal	631 to 794 mV (1000 mV)
Word-clock signal	1515 to 1907 mV (2400 mV)
High level (*1)	
NTSC Black Burst Signal	-210 to -264 mV (-286 mV)
PAL Black Burst Signal	-220 to -277 mV (-300 mV)
HD Tri-Level Sync Signal	379 to 535 mV (600 mV)
SD-SDI signal (270 Mb/s)	505 to 713 mV (800 mV)
HD-SDI signal (1.485 Gb/s)	505 to 713 mV (800 mV)
3G-SDI signal (2.97 Gb/s)	505 to 713 mV (800 mV)
AES/EBU Digital Audio Signal	734 to 924 mV (1000 mV)
Word-clock signal	1759 to 2215 mV (2400 mV)
User-defined level (*2)	
Ch1 to 8	-100 to -700 mV (when a signal that is equivalent to a horizontal sync signal is applied)
Ch9 and 10	100 to 1400 mV (p-p value of input signal)
Ch11	500 to 3000 mV (high level of input signal)
LTC	Signal amplitude 300 mVp-p or less (*3)

2. SPECIFICATIONS

Time from When the LT 4448 Turns On to When Error Detection Starts (*4)

Approx. 10 s (no delay) / Approx. 1 min. (60 to 80 s) /
Approx. 2 min. (120 to 140 s) / approx. 4 min. (240
to 320 s)

- *1 Depending on the instrument that you are using, there will be deviations in the detection level within the ranges shown.
The parenthetical values are levels during normal operation.
- *2 Depending on the shape of the waveform, the detection level that you have set may not be reached.
- *3 FAULT (LTC) on the front panel lights up with an error of any of the three systems LTC1 to LTC3, so input signals to all three systems.
- *4 The recommended setting when the power is started simultaneously with the LT4670 is approx. 4 min., and for the LT 4610 the recommended setting is approx. 2 min.

2.3.7 Alarm Detection

Alarm Indications	Indicates with LEDs when errors are detected in output signals (channels 3 to 11), or power supply.
Detection Setting	ON / OFF (*1)

- *1 If set to OFF, the alarm detection is disabled only for the output connector.

2.3.8 Key Lock

Lock and Unlock	Hold down the KEY LOCK key.
Auto Key Lock	Automatically locks the keys after 60 seconds of inactivity (no key operations)

2. SPECIFICATIONS

2.3.9 External Control Connectors

Remote Connector

Use	Remote control
Input	SYNC SOURCE, AUTO SWITCHING, RESET
Output	SYNC SOURCE, FAULT
Connector	9-pin D-sub (female)
Locking Screws	#4-40 inch screws

Ethernet Port

Use	Remote control and error monitoring from an external PC
Compliant Standards	10BASE-T/100BASE-TX auto switching
Protocol	
SNMP (SNMPv2c)	Remote monitoring, alarm occurrence
HTTP	Control through a browser
Supported browsers	FireFox (latest) Google Chrome (latest) Microsoft Edge (latest) IE9 or later (IE9, IE10, IE11)
Connector	RJ-45
SNMP Read Community (*1)	LDRUser (factory default)
SNMP Write Community (*1)	LDRAdm (factory default)
SNMP Trap Community (*1)	LDRUser (factory default)
SNMP negotiation	AUTO

*1 The SNMP Community name can be changed with the SNMP configuration software or the HTTP server feature.

USB Port

Use	IP address configuration
Compliant Standards	USB 2.0
Connector	Type B

2. SPECIFICATIONS

2.3.10 General Specifications

Environmental Conditions

Operating Temperature	0 to 40 °C
Operating Humidity Range	90 %RH or less (no condensation)
Optimal Temperature	5 to 35 °C
Optimal Humidity	85 %RH or less (no condensation)
Operating Environment	Indoors
Elevation	Up to 2,000 m
Overvoltage Category	II
Pollution Degree	2

Power Requirements

Redundancy	Supported
Voltage	90 to 250 VAC
Frequency	50/60 Hz
Power Consumption	40W max.

Dimensions

426 (W) × 44 (H) × 400 (D) mm (excluding protrusions)

Weight

4.0 kg (excluding rack support)

Accessories

Power cord.....	2
Rack supports	2
Rack support mounting screws	4

Sold Separately

LC2187 (LTC Connection Cables)	Conversion cables (1.5 m) for the 25-pin D-sub LTC connector and 9-pin D-sub REMOTE connector of the LT 4448, the two 26-pin D-sub LTC connectors for PRIMARY and BACKUP connected to the LT4670, and the three XLR connectors for LTC output
LC2185 (LTC Connection Cables)	Conversion cables (1.5 m) for the 25-pin D-sub LTC connector of the LT 4448, the two 26-pin D-sub LTC connectors for PRIMARY and BACKUP connected to the LT4670, and the three XLR connectors for LTC output
LC 2183 (LTC Connection Cables)	Conversion cables (1.5 m) for the 25-pin D-sub LTC connector of the LT 4448, the two 15-pin D-sub LTC connectors for PRIMARY and BACKUP connected to the LT 4610, and the three XLR connectors for LTC output

3. PANEL DESCRIPTION

3.1 Front Panel

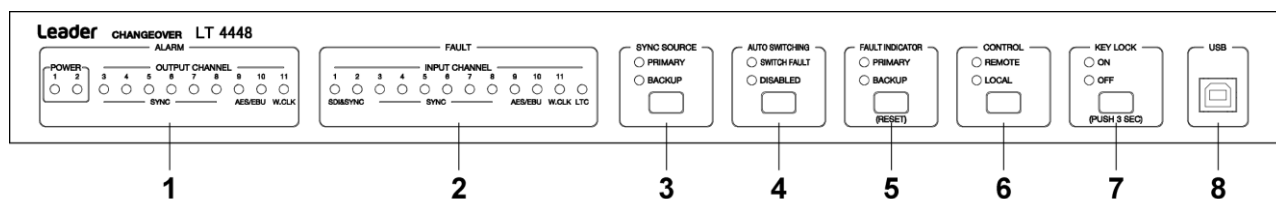

Figure 3-1 Front panel

Table 3-1 Front panel description

No.	Name	Description	Reference
1	ALARM	The LEDs light or blink when errors are detected in the power supply, or the output signals of channels 3 to 11.	4.9.2
2	FAULT	The LEDs light when faults are detected in the input signals.	4.9.1
3	SYNC SOURCE	Displays the signal that is being transmitted through the output connector. You can press the key to manually switch the signal that is being transmitted. The setting is shared among channels 1 to 11 and LTC.	4.8.2
4	AUTO SWITCHING	Selects whether the output signal will be switched automatically when a fault is detected in the input signal. The setting is shared among channels 1 to 11 and LTC. Select SWITCH FAULT to switch the output signal automatically. Select DISABLED to not switch the output signal automatically.	4.8.3
5	FAULT INDICATOR	The LEDs blink when faults are detected in the input signals. Press RESET to reset alarm indications and fault indications.	4.9.1
6	CONTROL	When LOCAL is lit, the top-panel DIP switch settings are valid. When REMOTE is lit, the settings from the SNMP or HTTP server feature are valid. Press the key to switch between LOCAL and REMOTE.	4.8.4
7	KEY LOCK	The LEDs indicate the key lock on/off state. You can press the key to turn the key lock on and off. Key lock turns on automatically after 1 minute of inactivity (no key operations).	4.8.4
8	USB	USB port. Connect to a PC to assign an IP address to the LT 4448.	6.1

3. PANEL DESCRIPTION

3.2 Rear Panel

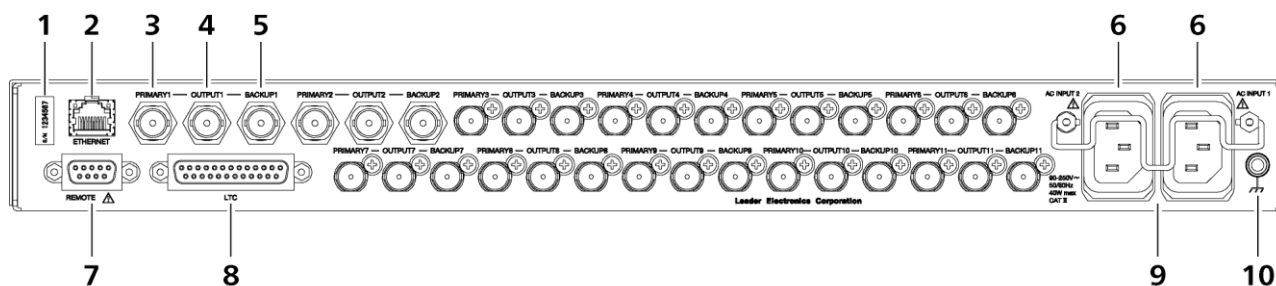

Figure 3-2 Rear panel

Table 3-2 Rear panel description

No.	Name	Description	Reference
1	Serial label	The serial number is printed on this label.	-
2	ETHERNET	Ethernet port. Supports SNMP, and HTTP.	6
3	PRIMARY	Primary signal input connector	4.6
4	OUTPUT	Transmits the signal that is received through PRIMARY or BACKUP	4.6
5	BACKUP	Backup signal input connector	4.6
6	AC INPUT 1 AC INPUT 2	AC inlet. Apply the cord stopper after inserting the power cord.	4.2
7	REMOTE	Remote control connector. You can use this connector to perform functions such as configuring the LT 4448 and transmitting fault information.	5
8	LTC	Time code I/O connector.	4.7
9	Code stopper	Power cord stopper.	4.2
10	Ground terminal	Connect to an external ground.	-

3. PANEL DESCRIPTION

3.3 Top Panel

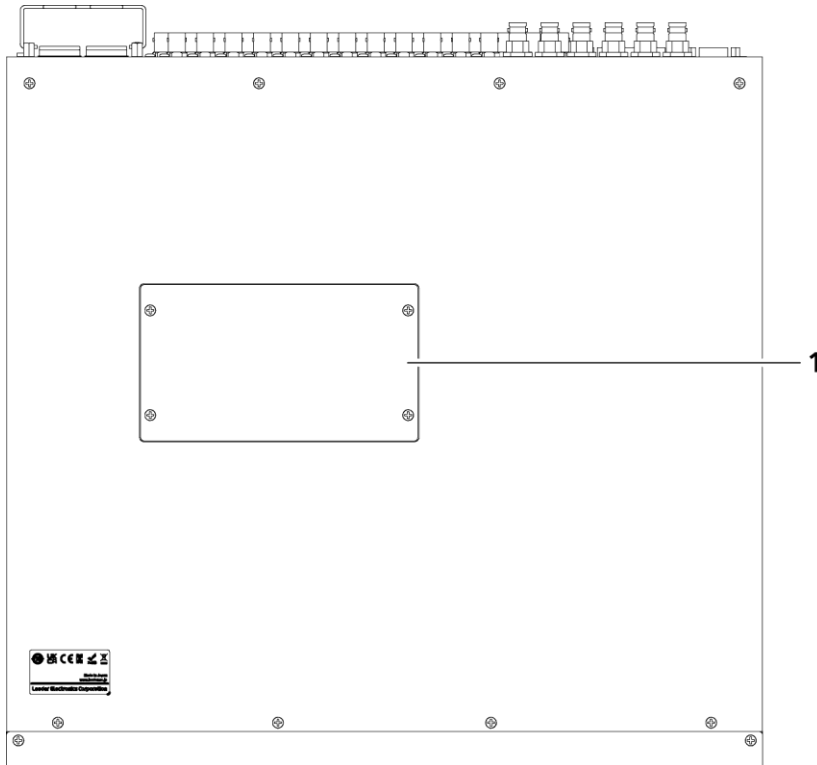

Figure 3-3 Top panel

Table 3-3 Top panel description

No.	Name	Description	Reference
1	DIP switch cover	Remove the four screws to access the DIP switches. You can use the DIP switches to configure the LT 4448. An explanation of the DIP switch settings is printed on the back side of the cover.	4.5

Input Signal Format		DIP SW No.								Input Channel
		1	2	3	4	5	6	7	8	
Disable(Do not detect.)		OFF	OFF	OFF	X	X	X	X	X	ch 1 to 11
NTSC		ON	OFF	OFF	X	X	X	X	X	ch 1 to 8
PAL		OFF	ON	OFF	X	X	X	X	X	ch 1 to 8
HD tri-level	720P	ON	ON	OFF	(A)	X	X	X	X	ch 1 to 8
Sync signal	1080I/P	OFF	OFF	ON	(A)	X	X	X	X	
User Define1		ON	OFF	ON	X	X	X	X	X	ch 1 to 11
User Define2		OFF	ON	ON	X	X	X	X	X	ch 1 to 11
SD-SDI		ON	ON	ON	X	X	X	OFF	OFF	ch 1 to 2
HD-SDI		ON	ON	ON	X	X	X	ON	OFF	ch 1 to 2
3G-SDI		ON	ON	ON	X	X	X	OFF	ON	ch 1 to 2
AES/EBU		ON	ON	ON	X	X	X	X	X	ch 9 to 10
WCLK		ON	ON	ON	X	X	X	X	X	ch11

DIP SW No.	MODE
1	OPERATING MODE ON: NORMAL OFF: OVERRIDE
2 to 3	POWER ON DELAY (B)
4	REMOTE INDICATOR ON:FAULT+ALARM OFF:FAULT

DIP SW No.	LTC & MODE
1	LTC ON/OFF
2 to 3	NOT USED
4	OUTPUT ALARM ON/OFF

DIP SW No.	VREF	(A) Frame rate	4	5	(B) DELAY TIME	2	3
1 to 10	ON: LOW OFF: HIGH	High (80,69,94,50) Low (30,29,97,25,24,23,98)	ON OFF	OFF ON	NOT DELAY	ON	ON
					1min	ON	OFF
					2min (Default)	OFF	ON
					4min	OFF	OFF

• ERROR DET SPEED (S1) setting is described on the Printed circuit board.
 • "X" The switch can be set to ON or OFF.

Figure 3-4 Printing on the back side of the DIP switch cover

4. HOW TO USE

4.1 Attaching Rack Supports

To rack mount the LT 4448, attach the supplied rack supports.

Using a Phillips head screwdriver (#2), torque the screws to 63 [cN•m].

Be sure to provide additional support for the body of the instrument. If you only use the rack supports to mount the instrument, the instrument case may deform or fall.

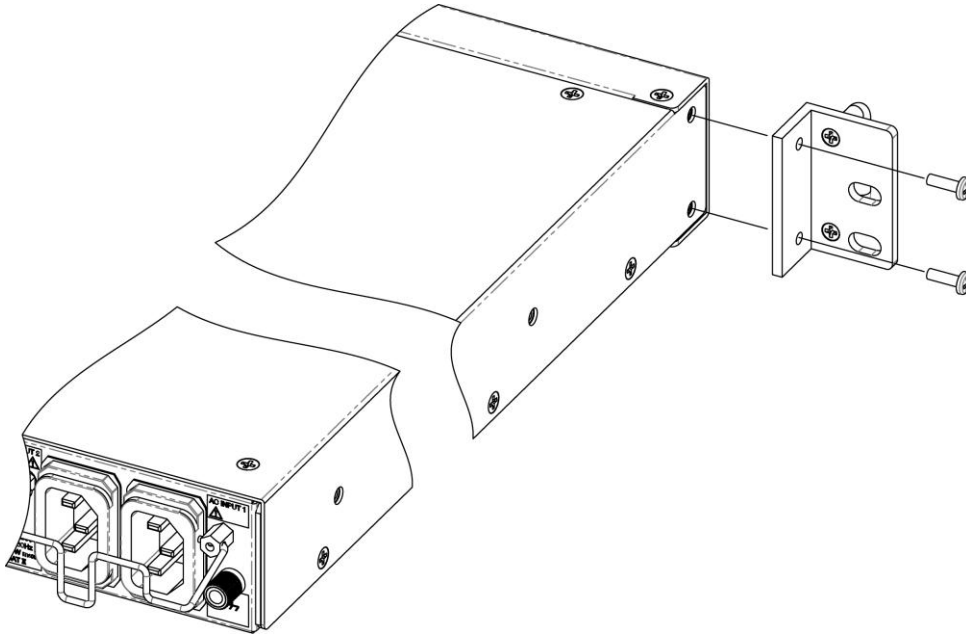

Figure 4-1 Attaching Rack Supports

4. HOW TO USE

4.2 Connecting and Disconnecting the Power Cord

A cord stopper is provided to prevent the power cord from being pulled free of the AC inlet. To connect and disconnect the power cord, follow the procedure below.

- Connection

1. Insert the power cord.

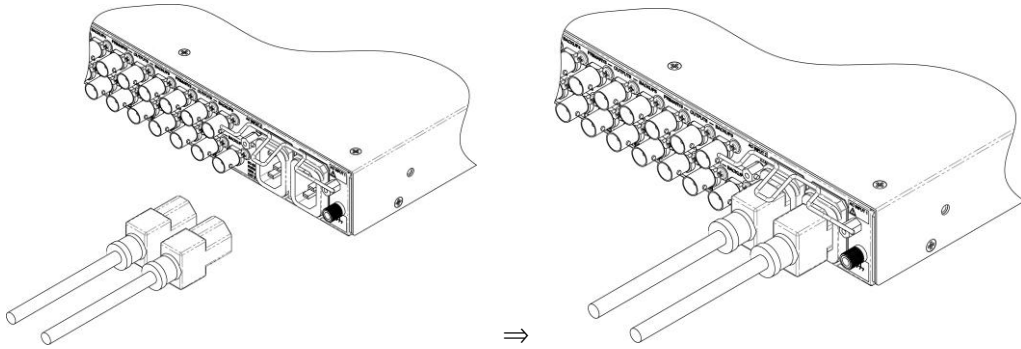

2. Lock the cord stopper.

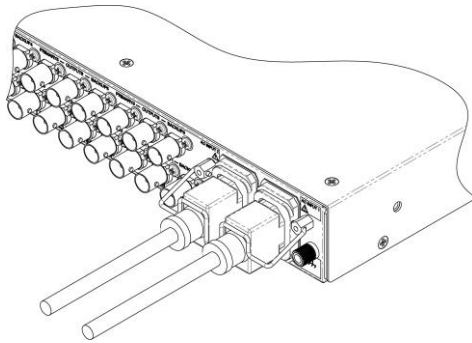

- Disconnection

Reverse the procedure for connecting the power cord.

4.3 Turning the Power On

The LT 4448 power supplies are redundant. When both power supplies are turned on, operation continues uninterrupted even if one of the power supplies fails.

Connect the power cords to AC INPUT 1 and AC INPUT 2. When the power turns on, the POWER 1 and POWER 2 indicators on the front panel light in green.

The LT 4448 uses a relay. A clicking noise can be heard when you turn the power ON or OFF, but this is not a sign that the instrument is malfunctioning.

- Standby

When you turn the power ON, the LT 4448 enters Standby mode. When on standby, the SYNC SOURCE PRIMARY, AUTO SWITCHING SWITCH FAULT, CONTROL LOCAL, and KEY LOCK ON and OFF LEDs light, and the AUTO SWITCHING DISABLED LED blinks. The LT 4448 does not function when it is in this state.

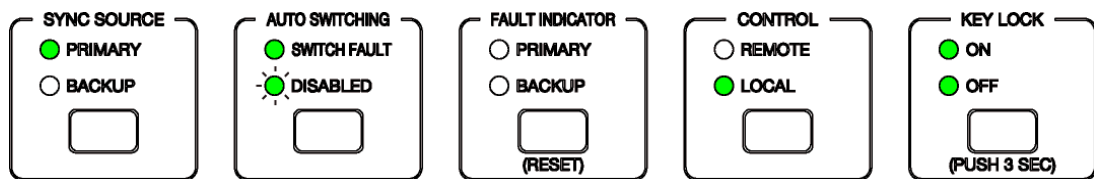

Figure 4-2 Standby mode

- Leaving Standby Mode

The LT 4448 has a last-memory feature. When the standby state ends, the LT 4448 is set to the conditions that it was in when the power was turned off the last time.

- Setting the Standby Time

You can use a DIP switch or Web browser to set the standby time. Select a setting that is appropriate for the rise time of the system signal source that you are connected to. The factory default setting is approximately 2 minute.

Reference 4.5.7, "Setting the Operation Mode and Standby Time"

4.4 Turning the Power Off

Remove the power cords from AC INPUT 1 and AC INPUT 2.

When you turn off the power, the output signals of channels 1 to 11 and LTC are set to PRIMARY.

4.5 DIP Switch Settings

When the front-panel CONTROL is set to LOCAL, Use the DIP switches on the top panel to configure the LT 4448. To access the DIP switches, first remove the DIP switch cover by unscrewing its four screws. To avoid errors, do not connect the signals until you have completed making all the settings.

The settings specified by DIP switches take effect after you restart the LT 4448. Be sure to restart the LT 4448 after changing the settings.

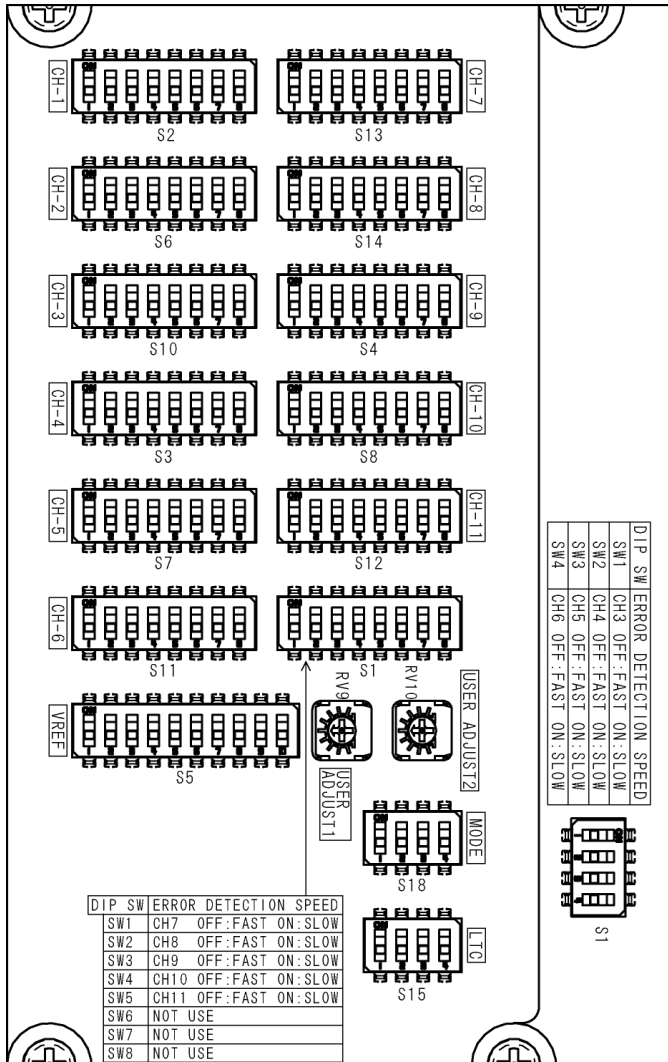

Figure 4-3 DIP switches

4. HOW TO USE

The settings are listed below. For details on each item, see the following sections in chapter 4.

A simple explanation of the settings is also printed on the back side of the DIP switch cover.

Table 4-1 List of settings

Setting	Name	Remark	Factory Default Value	
Ch1 to 11 Input signal settings	CH-1	S2	All OFF	No input signal
	CH-2	S6	All OFF	No input signal
	CH-3	S10	All OFF	No input signal
	CH-4	S3	All OFF	No input signal
	CH-5	S7	All OFF	No input signal
	CH-6	S11	All OFF	No input signal
	CH-7	S13	All OFF	No input signal
	CH-8	S14	All OFF	No input signal
	CH-9	S4	All OFF	No input signal
	CH-10	S8	All OFF	No input signal
	CH-11	S12	All OFF	No input signal
LTC Input signal settings	LTC	S15	SW1: OFF	No input signal
			SW2 and 3: OFF	-
Output alarm indication settings	OUTPUT ALARM		SW4: ON	On
Fault detection speed settings	ERROR DETECTION SPEED	S1 (Top row)	SW1: OFF	Ch3: High speed
			SW2: OFF	Ch4: High speed
			SW3: OFF	Ch5: High speed
			SW4: OFF	Ch6: High speed
	ERROR DETECTION SPEED	S1 (Bottom row)	SW1: OFF	Ch7: High speed
			SW2: OFF	Ch8: High speed
			SW3: OFF	Ch9: High speed
			SW4: OFF	Ch10: High speed
			SW5: OFF	Ch11: High speed
			SW6 to 8: OFF	-
Fault detection reference settings	VREF	S5	All ON	LOW Level
Fault detection level settings (user-defined)	USER ADJUST1	RV9	-	-
	USER ADJUST2	RV10	-	-
Operation mode, standby time, and fault information settings	MODE	S18	SW1: ON	NORMAL
			SW2: OFF	Approx. 2 minutes
			SW3: ON	
			SW4: OFF	FAULT Only

4. HOW TO USE

4.5.1 Setting Method

When one of the slide switches on the DIP switch is in the ON position, that switch is ON. When a slide switch is in the opposite position, it is OFF. Use an item that has a fine tip, such as a pen or a pair of tweezers, to move switches between the ON and OFF positions. When making settings, be careful to not touch any components other than the DIP switches.

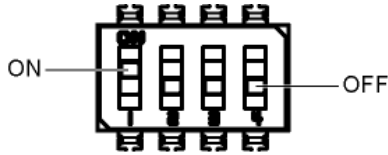

Figure 4-4 DIP switch ON and OFF positions

4.5.2 Setting the channel 1 to 11 input signals

Set the channel 1 to 11 input signal for each channel. The factory default setting is "no input signal" for all channels.

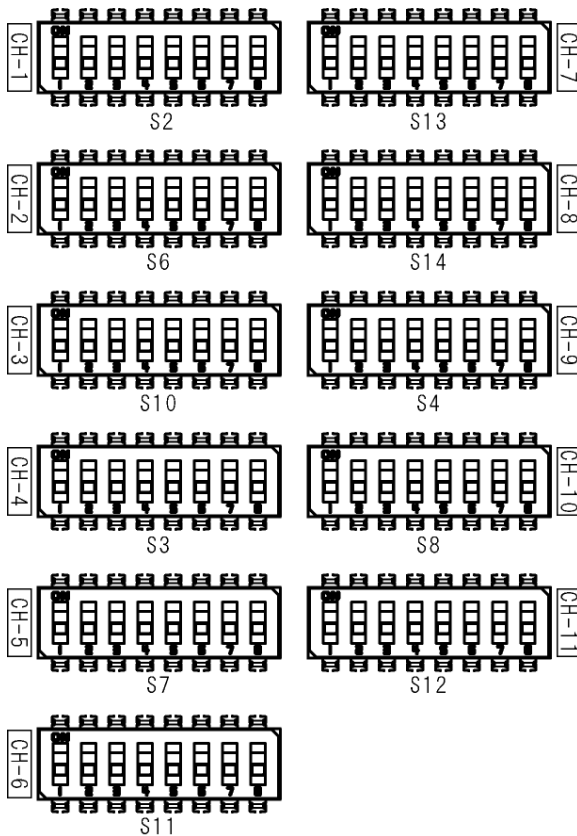

Figure 4-5 Setting the channel 1 to 11 input signals

4. HOW TO USE

The channels that you can apply signals to differ depending on the type of input signal as shown below.

The signal switching method is relay for channels 1 and 2 and electronic switch for channels 3 to 11.

If the specified signal is not received, it will be detected as a fault. For channels that will not receive signals, set SW1 to SW3 to OFF.

If you specify user-defined setting 1 or 2, you can set the fault detection level to a value that you want to use.

Reference 4.5.6, "Setting the Fault Detection Level (User-defined)"

"X" in the table indicates that the switch can be set to ON or OFF.

Table 4-2 Setting the channel 1 to 11 input signals

Input Signal	SW1	SW2	SW3	SW4	SW5	SW6	SW7	SW8	Input Channel
NTSC black burst signal	ON	OFF	OFF	X	X	X	X	X	Ch1 to 8
PAL black burst signal	OFF	ON	OFF	X	X	X	X	X	Ch1 to 8
HD tri-level sync signal	720P/60	ON	ON	OFF	ON	OFF	X	X	Ch1 to 8
	720P/59.94	ON	ON	OFF	ON	OFF	X	X	
	720P/50	ON	ON	OFF	ON	OFF	X	X	
	720P/30	ON	ON	OFF	OFF	ON	X	X	
	720P/29.97	ON	ON	OFF	OFF	ON	X	X	
	720P/25	ON	ON	OFF	OFF	ON	X	X	
	720P/24	ON	ON	OFF	OFF	ON	X	X	
	720P/23.98	ON	ON	OFF	OFF	ON	X	X	
	1080i/60	OFF	OFF	ON	ON	OFF	X	X	
	1080i/59.94	OFF	OFF	ON	ON	OFF	X	X	
	1080i/50	OFF	OFF	ON	ON	OFF	X	X	
	1080P/30	OFF	OFF	ON	OFF	ON	X	X	
	1080P/29.97	OFF	OFF	ON	OFF	ON	X	X	
	1080P/25	OFF	OFF	ON	OFF	ON	X	X	
1080P/24	OFF	OFF	ON	OFF	ON	X	X		
1080P/23.98	OFF	OFF	ON	OFF	ON	X	X		
SD-SDI signal (270 Mb/s)	ON	ON	ON	X	X	X	OFF	OFF	Ch1 and 2
HD-SDI signal (1.485 Gb/s)	ON	ON	ON	X	X	X	ON	OFF	Ch1 and 2
3G-SDI signal (2.97 Gb/s)	ON	ON	ON	X	X	X	OFF	ON	Ch1 and 2
AES/EBU Digital Audio Signal	ON	ON	ON	X	X	X	X	X	Ch9 and 10
Word-clock signal	ON	ON	ON	X	X	X	X	X	Ch11
User setting 1	ON	OFF	ON	X	X	X	X	X	Ch1 to 11
User setting 2	OFF	ON	ON	X	X	X	X	X	Ch1 to 11
No input signal	OFF	OFF	OFF	X	X	X	X	X	Ch1 to 11

4. HOW TO USE

4.5.3 Setting the LTC Input Signal and Output Alarm Indication

- Setting the LTC input signals

The setting applies to LTC1 to 3 input signals.
Electronic switches are used to switch the signals.

The factory default setting is “no input signal”.

- Setting the Output Alarm Indication

Turn the ALARM OUTPUT CHANNEL indicator on or off.

The factory default setting is on.

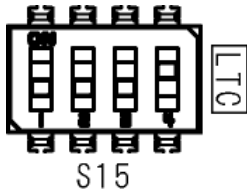

Figure 4-6 Setting the LTC Input Signal and Output Alarm Indication

Table 4-3 Setting the LTC Input Signal and Output Alarm Indication

Number	Setting	ON	OFF
SW1	LTC input signals	LTC1 to 3	No input signal
SW2	Not used (*1)	-	-
SW3	Not used (*1)	-	-
SW4	Output alarm indication	On	Off

*1 Unused switches can be set to on or off.

4. HOW TO USE

4.5.4 Setting the Fault Detection Speed

For each channel, select the length of time that must elapse before the LT 4448 automatically switches to the backup signal when a fault is detected in the primary signal. You can select this setting for channels 3 to 11. For channels 1 and 2, and LTC, it is fixed to 70 ms or less. Fault detection on channels 1 and 2, and LTC is performed on the signal level.

If you select low speed, fault detection is performed on the signal level. If you set the input signal type to user-defined, select low speed.

If you select high speed, fault detection is performed on whether the signal is present. If you select high speed, you do not need to set the fault detection reference.

The factory default setting is high speed for all channels.

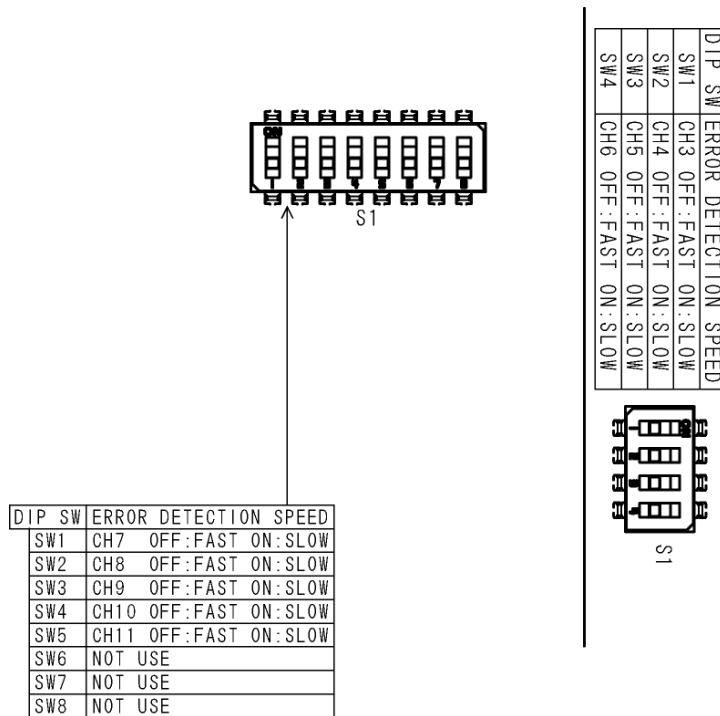

Figure 4-7 Setting the fault detection speed

4. HOW TO USE

Table 4-4 Setting the fault detection speed

DIP Switch Position	Number	Input channel	Fault Detection Speed	
			OFF (high speed)	ON (low speed)
Top row	SW1	Ch3	1.5 H or less	60 ms or less
	SW2	Ch4	1.5 H or less	60 ms or less
	SW3	Ch5	1.5 H or less	60 ms or less
	SW4	Ch6	1.5 H or less	60 ms or less
Bottom row	SW1	Ch7	1.5 H or less	60 ms or less
	SW2	Ch8	1.5 H or less	60 ms or less
	SW3	Ch9	6 us or less	60 ms or less
	SW4	Ch10	6 us or less	60 ms or less
	SW5	Ch11	60 us or less	60 ms or less
	SW6	Not used (*1)	-	-
	SW7	Not used (*1)	-	-
	SW8	Not used (*1)	-	-

*1 Leave unused switches in the OFF position.

4. HOW TO USE

4.5.5 Setting the Fault Detection Reference

If the fault detection speed is set to low speed or for channels 1 and 2, select the level at which a fault is to be detected for each input signal. The signal is low for on and high for off. LTC is fixed at 300 mV amplitude or less.

Normally, set VREF to LOW. If you set VREF to HIGH, faults may be detected due to signal level fluctuations or due to noise.

By factory default, all input signals are set to LOW.

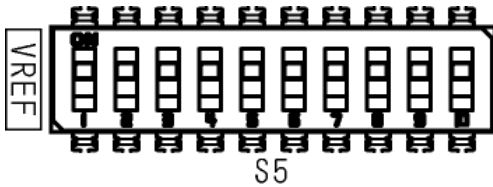

Figure 4-8 Fault detection reference settings

Table 4-5 Fault detection reference settings

Number	Input Signal	Fault Detection Level (*1)		Normal Level
		LOW	HIGH	
SW1	NTSC black burst signal	-180 to -227 mV	-210 to -264 mV	-286mV
SW2	PAL black burst signal	-190 to -238 mV	-220 to -277 mV	-300mV
SW3	HD tri-level sync signal	337 to 476 mV	379 to 535 mV	600mV
SW4	AES/EBU Digital Audio Signal	631 to 794 mV	734 to 924 mV	1000mV
SW5	Not used	-	-	-
SW6	Not used	-	-	-
SW7	SD-SDI signal (270 Mb/s)	450 to 635 mV	505 to 713 mV	800mV
SW8	HD-SDI signal (1.485 Gb/s)	450 to 635 mV	505 to 713 mV	800mV
SW9	3G-SDI signal (2.97 Gb/s)	450 to 635 mV	505 to 713 mV	800mV
SW10	Word-clock signal	1515 to 1907 mV	1759 to 2215 mV	2400mV

*1 Depending on the instrument that you are using, there will be deviations in the fault detection level within the ranges given in this table.

4.5.6 Setting the Fault Detection Level (User-defined)

Set up to two input signal levels at which a fault is to be detected.

In section 4.5.2, "Setting the channels 1 to 11 input signal," specify user setting 1 or user setting 2 before adjusting the trimmer.

USER ADJUST2



Table 4-9 Fault detection level settings

The trimmer adjustment range varies depending on the input channel as follows.

Table 4-6 Fault detection level settings

Input Channel	Adjustment Range
Ch1 to 8	-100 to -700 mV
Ch9 and 10	100 to 1400 mV
Ch11	500 to 3000 mV

● User Setting Example

Below is an example of a procedure to apply signals to channel 1 using user setting 1.

1. Set DIP switches SW1 and SW3 of CH-1 (S2) to ON.
2. Restart the LT 4448 to apply the new settings.
3. Connect between the input signal and PRIMARY an attenuator with an appropriate attenuation (3 to 6 dB) for detecting faults.
4. While turning USER ADJUST1 (RV9), press RESET repeatedly, and stop when the PRIMARY FAULT INDICATOR LED turns off.
5. Slowly turn the USER ADJUST1 trimmer backwards, and stop when the PRIMARY FAULT INDICATOR LED starts blinking.
6. Remove the attenuator, and connect the input signal to PRIMARY and BACKUP.
7. Check that the PRIMARY and BACKUP FAULT INDICATOR LEDs are turned off, and you are finished.

4.5.7 Setting the Operation Mode, Standby Time and Fault information

- Setting the Operation Mode

Normally, you can use the front-panel SYNC SOURCE key to switch the output signal, but when faults are detected in either of the input signals (primary or backup), you cannot switch to the fault signal.

If you set the operation mode to OVERRIDE, regardless of the state of the input signals, you can use the SYNC SOURCE key to switch the output signal. However, this setting is valid when AUTO SWITCHING is set to DISABLED. If AUTO SWITCHING is set to SWITCH FAULT, even if you set the operation mode to OVERRIDE, you cannot switch to the fault signal.

The factory default setting is NORMAL. Leave this set to NORMAL under standard operating circumstances.

Reference For details on the SYNC SOURCE key, see section 4.8.2, "Switching the Output Signal."
For details on the AUTO SWITCHING key, see section 4.8.3, "Setting Automatic Signal Switching."

- Setting the Standby Time

You can select the length of time that the LT 4448 waits from the time that it turns ON to the time that it begins operating. Select a setting that is appropriate for the rise time of the system signal source that you are connected to.

The factory default setting is approximately 2 minute.

4. HOW TO USE

● Setting the Fault information

You can set the contents of the fault information to be output from the remote connector on the rear panel.

If set to FAULT Only, when a fault is detected in PRIMARY or BACKUP, the fault indicator transmits a high-level signal and the positive and negative fault indicators conduct current.

If set to FAULT+ALARM, when a fault is detected in PRIMARY or BACKUP and an alarm is detected in any of the outputs (Ch3 to 11) or the power supply, the fault indicator transmits a high-level signal and the positive and negative fault indicators conduct current.

The factory default setting is FAULT Only.

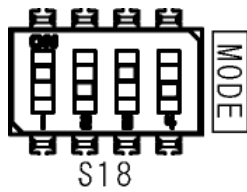

Figure 4-10 Setting the Operation Mode, Standby Time and Fault information

Table 4-7 Setting the Operation Mode, Standby Time and Fault information

Number	Setting	ON	OFF
SW1	Operation mode	NORMAL	OVERRIDE
SW2	Standby time	See Table 4-8	
SW3			
SW4	Fault information	FAULT+ALARM	FAULT Only

Table 4-9 Setting the Standby Time

Standby Time	SW2	SW3
No standby time	ON	ON
Approx. 1 minutes	ON	OFF
Approx. 2 minutes (factory default setting)	OFF	ON
Approx. 4 minutes	OFF	OFF

4.6 Ch1 to 11 Signal I/O

Apply the primary signal to PRIMARY1 to 11 and the backup signal to BACKUP1 to 11.

The input signal impedance is 75 Ω. Terminate the output connectors at 75 Ω. (The signal that is not selected with the front-panel SYNC SOURCE setting is terminated internally at 75 Ω.)

Depending on the front-panel SYNC SOURCE setting, the primary or backup signal is transmitted from OUTPUT1 to 11.

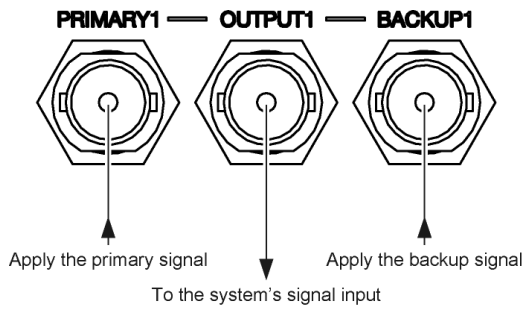

Figure 4-11 Ch1 to 11 Signal I/O

The types of signals that you can apply differ depending on the channel as shown below.

Table 4-10 Operation mode and standby time settings

Input Channel	Input Signal	Signal Switching Method
Ch1 and 2	NTSC black burst signal PAL black burst signal HD tri-level sync signal SD-SDI signal (270 Mb/s) HD-SDI signal (1.485 Gb/s) 3G-SDI signal (2.97 Gb/s)	Relays
Ch3 to 8	NTSC black burst signal PAL black burst signal HD tri-level sync signal	Electrical switches
Ch9 and 10	AES/EBU Digital Audio Signal	Electrical switches
Ch11	Word-clock signal	Electrical switches

4.7 LTC Signal I/O

LTC on the rear panel receives and outputs time codes and outputs alarms. On the LT 4448, time codes are called LTC1 to LTC3.

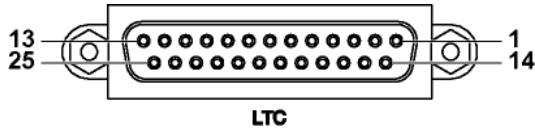

Pin No.	Pin Name	I/O
1	GND	-
2	LTC1+_P	I
3	LTC1+_O	O
4	LTC1+_B	I
5	LTC2+_P	I
6	LTC2+_O	O
7	LTC2+_B	I
8	LTC3+_P	I
9	LTC3+_O	O
10	LTC3+_B	I
11	GND	-
12	GPI_P	I
13	GPI_B	I

Pin No.	Pin Name	I/O
14	LTC1-_P	I
15	LTC1-_O	O
16	LTC1-_B	I
17	LTC2-_P	I
18	LTC2-_O	O
19	LTC2-_B	I
20	LTC3-_P	I
21	LTC3-_O	O
22	LTC3-_B	I
23	GND	-
24	GPI_P_O	O
25	GPI_B_O	O

● Time Code I/O

Apply the primary signal to LTC1 to 3+_P and LTC1 to 3-_P and the backup signal to LTC1 to 3+_B and LTC1 to 3-_B.

Depending on the front-panel SYNC SOURCE setting, the primary or backup signal is transmitted from LTC1 to 3+_O and LTC1 to 3-_O.

Switching method between the primary signal and the spare signal is electronic switch.

● Alarm output

Apply the primary signal to GPI_P and the backup signal to GPI_B. They are passed through to GPI_P_O and GPI_B_O, respectively.

4. HOW TO USE

4.7.1 LTC Connection Cables (Sold Separately)

Dedicated cables are available for transmitting LTC signals when connecting to the LT4670 / LT 4610.

- LC2187: LTC cable for LT4448 / LT4670
- LC2185: LTC cable for LT4448 / LT4670
- LC2183: LTC cable for LT4448 / LT 4610

● LC2187

This cable connects the LTC and REMOTE on the rear panel to the primary signal source LT4670, the backup signal source LT4670, and the LTC signal. In addition to transmitting the LTC signal, it allows for linked operation of PTP and LT4448. (LT4670-SER03 is required for PTP linkage)

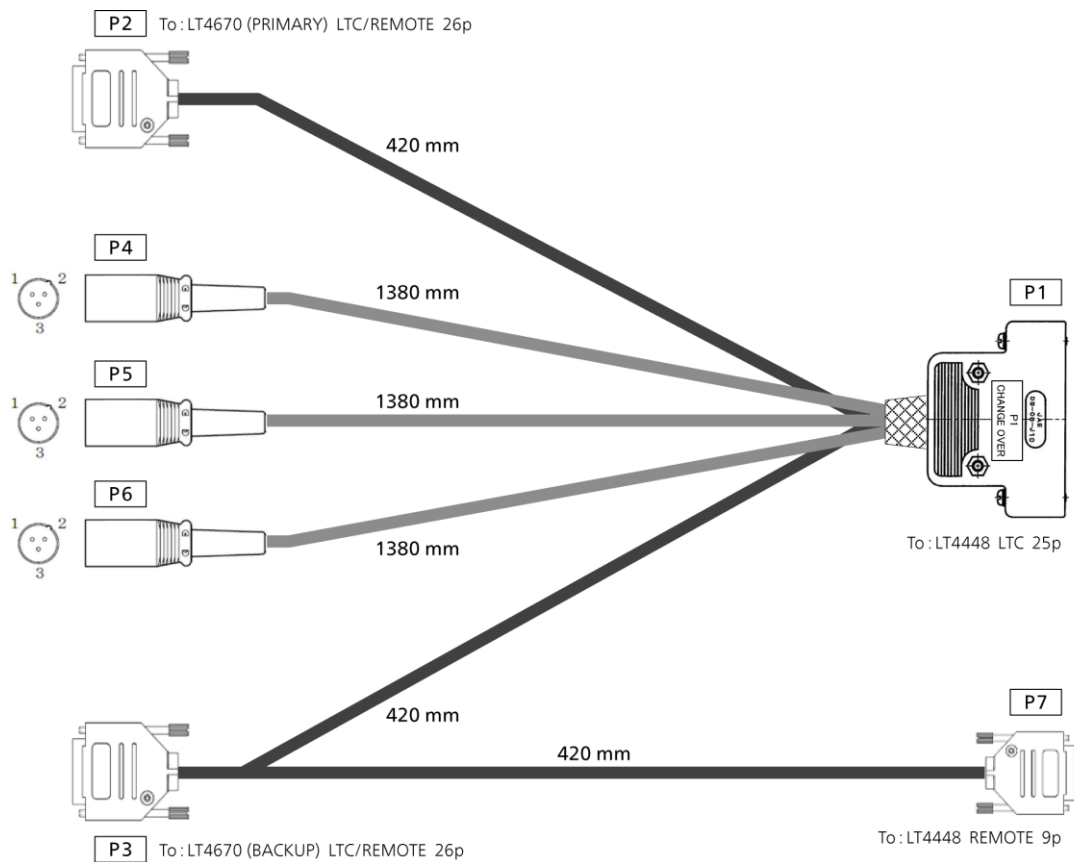

Figure 4-12 LC2187

4. HOW TO USE

● LC2185

This cable connects the LTC on the rear panel to the primary signal source LT4670, the backup signal source LT4670, and the LTC signal.

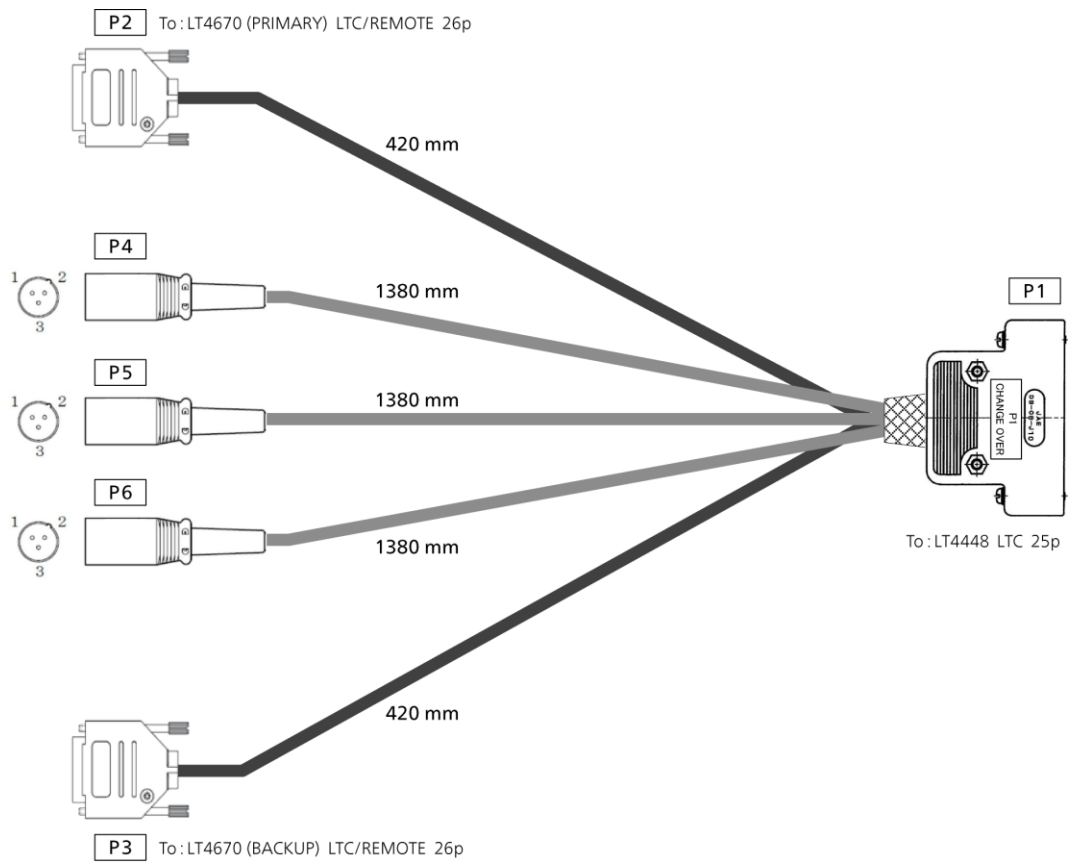

Figure 4-13 LC2185

4. HOW TO USE

● LC2183

This cable connects the LTC on the rear panel to the primary signal source LT 4610 (SER01 or SER04 implemented), the backup signal source LT 4610 (SER01 or SER04 implemented), and the LTC signal.

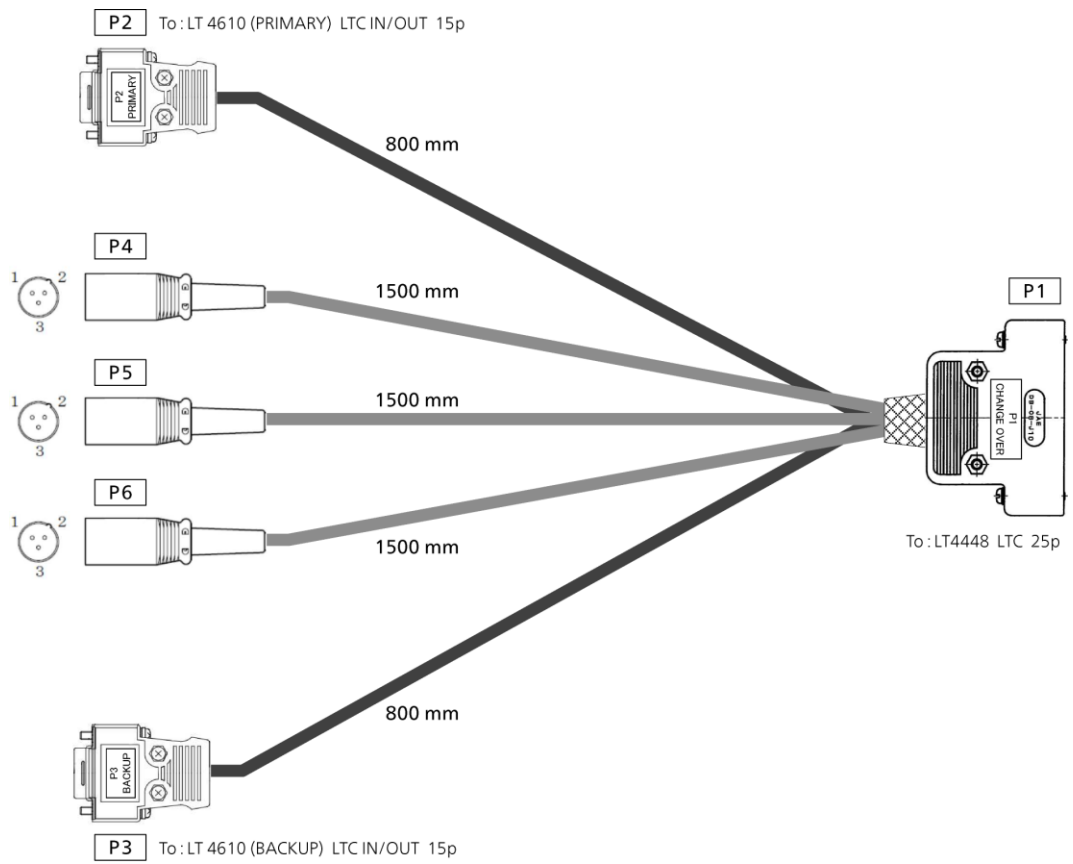

Figure 4-14 LC2183

4. HOW TO USE

● P1 (25-pin D-sub)

Connect to the LTC connector on the rear panel.

Pin No.	Pin Name	I/O	Pin No.	Pin Name	I/O
1	GND_P	-	14	LTC1-_P	O
2	LTC1+_P	O	15	LTC1-_O	I
3	LTC1+_O	I	16	LTC1-_B	O
4	LTC1+_B	O	17	LTC2-_P	O
5	LTC2+_P	O	18	LTC2-_O	I
6	LTC2+_O	I	19	LTC2-_B	O
7	LTC2+_B	O	20	LTC3-_P	O
8	LTC3+_P	O	21	LTC3-_O	I
9	LTC3+_O	I	22	LTC3-_B	O
10	LTC3+_B	O	23	GND_B	-
11	GND_O	-	24*	GPI_P_O	I
12	GPI_P	O	25*	GPI_B_O	I
13	GPI_B	O			

* For LC2183, it is open.

● P2

• LC2187 / LC2185 (26-pin D-sub)

Connect to the LTC/REMOTE connector on the rear panel of the primary signal source LT4670.

Pin No.	Pin Name	I/O	Pin No.	Pin Name	I/O	Pin No.	Pin Name	I/O
1	OPEN	-	10	OPEN	-	19	OPEN	-
2	GND_P	-	11	OPEN	-	20	OPEN	-
3	LTC1+_P	I	12	LTC1-_P	I	21	OPEN	-
4	LTC2+_P	I	13	LTC2-_P	I	22	OPEN	-
5	LTC3+_P	I	14	LTC3-_P	I	23	OPEN	-
6	OPEN	-	15	OPEN	-	24	OPEN	-
7	OPEN	-	16	GPI_P	I	25	GPI_P_O	O
8	OPEN	-	17	OPEN	-	26	OPEN	-
9	OPEN	-	18	OPEN	-			

• LC 2183 (15-pin D-sub)

Connect to the LTC IN/OUT connector on the rear panel of the primary signal source LT 4610.

Pin No.	Pin Name	I/O	Pin No.	Pin Name	I/O	Pin No.	Pin Name	I/O
1	OPEN	-	6	OPEN	-	11	OPEN	-
2	LTC1+_P	I	7	OPEN	-	12	GPI_P	I
3	LTC2+_P	I	8	LTC1-_P	I	13	OPEN	-
4	LTC3+_P	I	9	LTC2-_P	I	14	OPEN	-
5	GND_P	-	10	LTC3-_P	I	15	OPEN	-

4. HOW TO USE

●P3

• LC2187 (26-pin D-sub)

Connect to the LTC/REMOTE connector on the rear panel of the backup signal source LT4670.

Pin No.	Pin Name	I/O	Pin No.	Pin Name	I/O
1	OPEN	-	14	LTC3-_B	I
2	OPEN	-	15	GND_B	-
3	LTC1+_B	I	16	CHGOV_O_0	I
4	LTC2+_B	I	17	CHGOV_O_1	I
5	LTC3+_B	I	18	OPEN	-
6	OPEN	-	19	OPEN	-
7	OPEN	-	20	OPEN	-
8	OPEN	-	21	OPEN	-
9	OPEN	-	22	OPEN	-
10	OPEN	-	23	PRESET4	I
11	OPEN	-	24	GND_B	-
12	LTC1-_B	I	25	CHGOV_I	O
13	LTC2-_B	I	26	OPEN	-

• LC2185 (26-pin D-sub)

Connect to the LTC/REMOTE connector on the rear panel of the backup signal source LT4670.

Pin No.	Pin Name	I/O	Pin No.	Pin Name	I/O	Pin No.	Pin Name	I/O
1	OPEN	-	10	OPEN	-	19	OPEN	-
2	OPEN	-	11	OPEN	-	20	OPEN	-
3	LTC1+_B	I	12	LTC1-_B	I	21	OPEN	-
4	LTC2+_B	I	13	LTC2-_B	I	22	OPEN	-
5	LTC3+_B	I	14	LTC3-_B	I	23	OPEN	-
6	OPEN	-	15	OPEN	-	24	GND_B	-
7	OPEN	-	16	OPEN	-	25	GPI_B_O	O
8	OPEN	-	17	GPI_B	I	26	OPEN	-
9	OPEN	-	18	OPEN	-			

• LC 2183 (15-pin D-sub)

Connect to the LTC IN/OUT connector on the rear panel of the backup signal source LT 4610.

Pin No.	Pin Name	I/O	Pin No.	Pin Name	I/O	Pin No.	Pin Name	I/O
1	OPEN	-	6	OPEN	-	11	OPEN	-
2	LTC1+_B	I	7	OPEN	-	12	GPI_B	I
3	LTC2+_B	I	8	LTC1-_B	I	13	OPEN	-
4	LTC3+_B	I	9	LTC2-_B	I	14	OPEN	-
5	GND_B	-	10	LTC3-_B	I	15	OPEN	-

4. HOW TO USE

- P4 (3-pin XLR)

LTC1 output. Connect to the system signal input.

Pin No.	Pin Name	I/O
1	GND_O	-
2	LTC1+_O	O
3	LTC1-_O	O

- P5 (3-pin XLR)

LTC2 output. Connect to the system signal input.

Pin No.	Pin Name	I/O
1	GND_O	-
2	LTC2+_O	O
3	LTC2-_O	O

- P6 (3-pin XLR)

LTC3 output. Connect to the system signal input.

Pin No.	Pin Name	I/O
1	GND_O	-
2	LTC3+_O	O
3	LTC3-_O	O

- P7 (9-pin D-sub)

Connect to the REMOTE connector on the rear panel.

Pin No.	Pin Name	I/O
1	AUTO_SW	O
2	SYNC_S	O
3	SYNC_S_P	I
4	SYNC_S_B	I
5	FAULT_I	I
6	RESET	O
7	FAULT_I+	I
8	FAULT_I-	I
9	GND	-

4.8 LT 4448 Configuration

The LT 4448 has a last-memory feature. When the power is turned on, the LT 4448 is set to the conditions that it was in when the power was turned off the last time.

4.8.1 Setting the Key Lock

The LT 4448 locks its keys after 1 minute of inactivity (no key operations). When the key lock is on, front-panel key operations are not accepted. (except for CONTROL)

To perform front-panel key operations, turn the key lock off. Hold down the KEY LOCK key for 3 seconds to turn the key lock on and off.

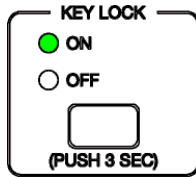

Figure 4-15 KEY LOCK

4.8.2 Switching the Output Signal

The SYNC SOURCE area shows the signal that is being transmitted through the output connector (PRIMARY or BACKUP). The setting is shared among channels 1 to 11 and LTC.

You can press the key to manually switch the output signal. However, you may not be able to switch the signal depending on the LT 4448 state. For details, see section 4.8.3, "Setting Automatic Signal Switching."

The factory default setting is PRIMARY.

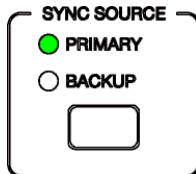

Figure 4-16 SYNC SOURCE

4. HOW TO USE

4.8.3 Setting Automatic Signal Switching

In the AUTO SWITCHING area, select whether the output signal will be switched automatically when a fault is detected in the input signal. The setting is shared among channels 1 to 11 and LTC.

If you select SWITCH FAULT, the LT 4448 will automatically switch to the other signal (PRIMARY or BACKUP) when a fault is detected in the output signal. Normally use this setting.

Select DISABLED to not switch the output signal automatically even when a fault is detected. Use this setting when you want to just detect faults.

The factory default setting is SWITCH FAULT.

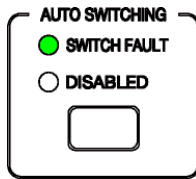

Figure 4-17 AUTO SWITCHING

4. HOW TO USE

Depending on the AUTO SWITCHING setting and the MODE DIP switch setting, the operation of the LT 4448 differs as shown below.

Reference For details on MODE, see 4.5.7, "Setting the Operation Mode, Standby Time and Fault information"

Table 4-11 LT 4448 operations

LT 4448 Setting		Input Signal Status	When SYNC SOURCE is PRIMARY		When SYNC SOURCE is BACKUP	
AUTO SWITCHING	MODE		Output Signal	SYNC SOURCE Key Operation	Output Signal	SYNC SOURCE Key Operation
SWITCH FAULT	NORMAL OVERRIDE	Normal	Remains at PRIMARY	Switches to BACKUP	Remains at BACKUP	Switches to PRIMARY
		Fault on BACKUP	Remains at PRIMARY	Remains at PRIMARY	Switches to PRIMARY	Remains at PRIMARY
		Fault on PRIMARY	Switches to BACKUP	Remains at BACKUP	Remains at BACKUP	Remains at BACKUP
		Fault on both	Remains at PRIMARY	Switches to BACKUP	Remains at BACKUP	Switches to PRIMARY
DISABLED	NORMAL	Normal	Remains at PRIMARY	Switches to BACKUP	Remains at BACKUP	Switches to PRIMARY
		Fault on BACKUP	Remains at PRIMARY	Remains at PRIMARY	Remains at BACKUP	Switches to PRIMARY
		Fault on PRIMARY	Remains at PRIMARY	Switches to BACKUP	Remains at BACKUP	Remains at BACKUP
		Fault on both	Remains at PRIMARY	Switches to BACKUP	Remains at BACKUP	Switches to PRIMARY
	OVERRIDE	Normal	Remains at PRIMARY	Switches to BACKUP	Remains at BACKUP	Switches to PRIMARY
		Fault on BACKUP	Remains at PRIMARY	Switches to BACKUP	Remains at BACKUP	Switches to PRIMARY
		Fault on PRIMARY	Remains at PRIMARY	Switches to BACKUP	Remains at BACKUP	Switches to PRIMARY
		Fault on both	Remains at PRIMARY	Switches to BACKUP	Remains at BACKUP	Switches to PRIMARY

4.8.4 Switching the Control

When LOCAL is lit, the top-panel DIP switch settings are valid. When REMOTE is lit, the settings from the SNMP or HTTP server feature are valid.

Press the key to switch between LOCAL and REMOTE. When switched from LOCAL to REMOTE, the LT 4448 is set to the conditions configured in the web browser.

Reference See 6.3, "HTTP Server Feature"

The factory default setting is LOCAL.

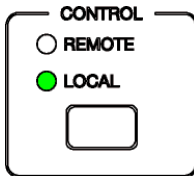

Figure 4-18 CONTROL

4.9 LT 4448 Indications

4.9.1 Fault Indication

● Fault Indication

There are two areas for indicating faults: FAULT and FAULT INDICATOR. Both areas indicate the fault detection of input signals.

In the FAULT area, the LED of a fault-detected channel lights in red.

In the FAULT INDICATOR area, the relevant LED blinks in red when a fault is detected in any of the PRIMARY or BACKUP channels.

For example, if a fault is detected in PRIMARY channel 1, the LEDs light or blink as follows.

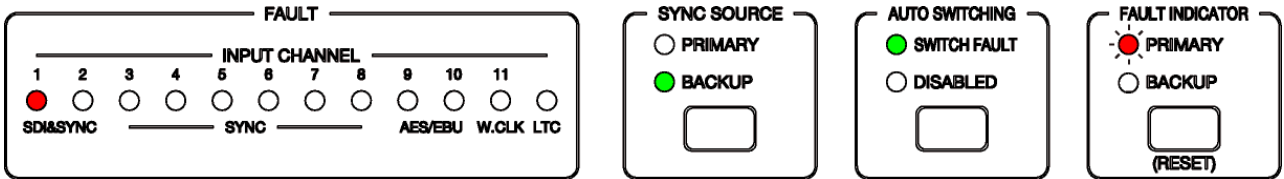

Figure 4-19 Fault indication 1

If a fault is detected in BACKUP channel 2, the LEDs light or blink as follows.

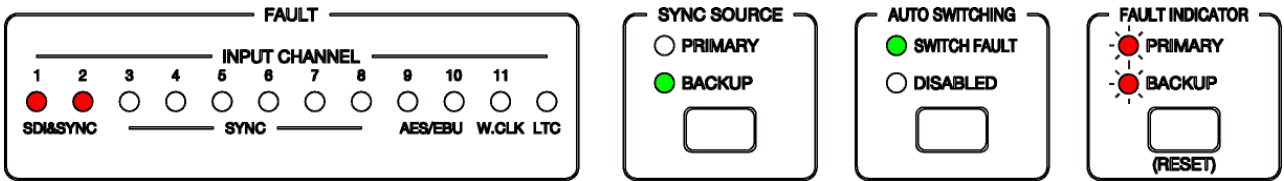

Figure 4-20 Fault indication 2

● Resetting Fault Indications

Once a fault is detected, even if the input signals return to normal, the FAULT and FAULT INDICATOR LEDs will continue to light and blink. To reset these fault indications, apply proper signals, and then press RESET. The fault indications will turn off.

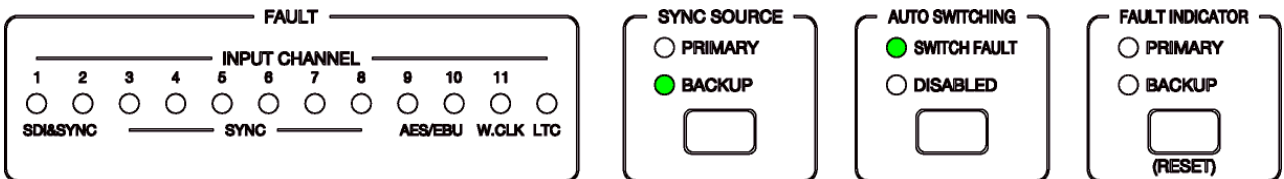

Figure 4-21 Resetting fault indications

4.9.2 Alarm Indications

● Output Alarm Indications (Channels 3 to 11 only)

Signals received through PRIMARY or BACKUP are usually output through amplifiers, but if an error is detected in the amplifier or output signal, the relevant ALARM LED lights in red. In such a case, the output connector transmits the input signal as-is without passing through the amplifier.

The indicators do not light when the output alarm indication is turned off with the DIP switch.

Reference See 4.5.3, "Setting the LTC Input Signal and Output Alarm Indication"

If an ALARM LED lights, check that the output signal is connected properly, and then press RESET. If the LED does not turn off even after you press RESET, contact your local LEADER agent.

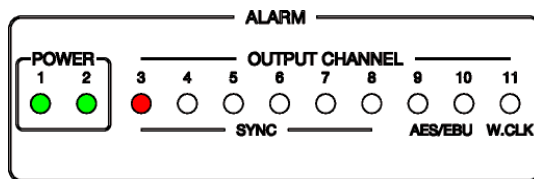

Figure 4-22 Output alarm indications

● Power Supply Alarm Indications

The ALARM POWER LED or the ALARM on the power supply unit lights in red in the following situations. If the LED lights in red even when you turn on both power supplies, contact your local LEADER agent.

- When an error occurs in the power supply output
- When one of the power supplies is not turned on (the LED of the power supply that is off lights)

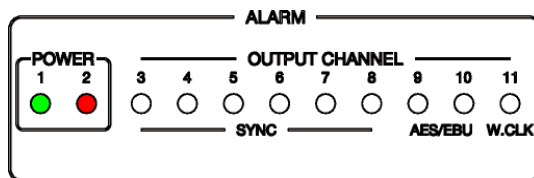

Figure 4-23 Power supply alarm indications

5. REMOTE CONTROL

You can use the rear-panel remote-control connector to perform functions such as configuring the LT 4448 and transmitting fault information.

The remote control connector and its pin assignments are shown below.

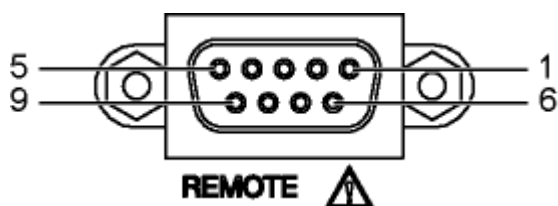

Figure 5-1 Remote-control connector (9-pin D-sub, female, #4-40 inch screws)

Table 5-1 Remote connector functions

Pin No.	Name	I/O	Description
1	AUTO SWITCHING	I	When the front-panel AUTO SWITCHING is set to SWITCH FAULT, applying a low-level signal sets AUTO SWITCHING to DISABLED, and applying a high-level signal (or opening the circuit) sets AUTO SWITCHING to SWITCH FAULT. When the front-panel AUTO SWITCHING is set to DISABLED, remote control is not possible. Set AUTO SWITCHING to SWITCH FAULT using keys to enable remote control.
2	SYNC SOURCE	I	Each time a low-level signal is applied, SYNC SOURCE switches between PRIMARY and BACKUP.
3	SYNC SOURCE (PRIMARY)	O	Transmits a high-level signal when SYNC SOURCE is set to PRIMARY.
4	SYNC SOURCE (BACKUP)	O	Transmits a high-level signal when SYNC SOURCE is set to BACKUP.
5	FAULT INDICATOR	O	Transmits a high-level signal when a fault is detected in PRIMARY or BACKUP when the MODE SW4 DIP switch or setting from the SNMP or HTTP server is set to FAULT Only. Transmits a high-level signal when a fault is detected in PRIMARY or BACKUP when the MODE SW4 DIP switch or setting from the SNMP or HTTP server is set to FAULT+ALARM and an alarm is detected in any of the outputs (Ch3 to 11) or the power supply. (*1) Even when the input signal returns to normal, the LT 4448 retains the high-level signal until the error is reset.
6	RESET	I	Apply a low-level signal to reset fault detection.
7	FAULT INDICATOR+	O	Open during normal operation. Conducts current when the power is not on. Conducts current when a fault is detected in PRIMARY or BACKUP when the MODE SW4 DIP switch or setting from the SNMP or HTTP server is set to FAULT Only. Conducts current when a fault is detected in PRIMARY or BACKUP when the MODE SW4 DIP switch or setting from the SNMP or HTTP server is set to FAULT+ALARM and an alarm is detected in any of the outputs (Ch3 to 11) or the power supply. (*1) Use these pair of pins when you want to electrically isolate the connected device from the LT 4448. (There is a photocoupler inside the LT 4448 that is used for isolation.)
8	FAULT INDICATOR-		
9	GND	-	Ground

*1 When the output alarm indication DIP switch is set to off, alarms are not detected in the outputs (Ch3 to 11). Alarms are detected only in the power supply.

Reference See 4.5.3, "Setting the LTC Input Signal and Output Alarm Indication"

5. REMOTE CONTROL

Table 5-2 Remote connector I/O specifications

Pin No.	I/O	I/O Specifications	Connection Example
1	I		<p>Connect a switch to apply a low-level signal. Connect one side of the switch to the remote connector and the other side to ground.</p>
2			
6			
3	O		<p>Connect an LED so that it will light when a high-level signal is transmitted.</p>
4			<p>Connect the anode to the remote connector and the cathode to ground.</p>
5	O		
7	O	<p>24VDC 20mA Max. Normal : OPEN Power OFF or NG : CLOSE</p>	-
8			

6. ETHERNET CONTROL

The LT 4448 can be controlled using the SNMP or HTTP server feature.

CONTROL on the front panel of the LT 4448 must be set to REMOTE to enable the DIP switch settings from the SNMP or HTTP server feature.

When CONTROL is switched from LOCAL to REMOTE, the LT 4448 is set to the previous conditions.

- * The Ethernet features of the LT 4448 have only been confirmed to work in a local network environment. LEADER does not guarantee that they will work in any network environment.
- * DHCP client and DNS resolver features are not supported.

6.1 SNMP Configuration Software

Before using the SNMP or HTTP server feature, you must assign an IP address to the LT 4448. To do so, you need to first install the SNMP configuration software (hereafter referred to as the software) in your PC and connect the LT 4448 to your PC. Have a PC and USB cable (A/B) ready.

The supported Windows versions are as follows.

- Windows 7 32 bit
- Windows 7 64 bit
- Windows 8
- Windows 10

6.1.1 Installation

Follow the procedure below to install the software in your PC.

To update the software, uninstall the old version, and then install the new version.

1. Download and unzip the SNMP configuration software from our website, and run Setup.msi. (User registration to my Leader is required.)

<https://www.leader.co.jp/en/support/download/lt4448/>

6. ETHERNET CONTROL

2. When the following window appears, click Next.



Figure 6-1 Installation 1

3. When the following window appears, select the installation folder, and click Next.

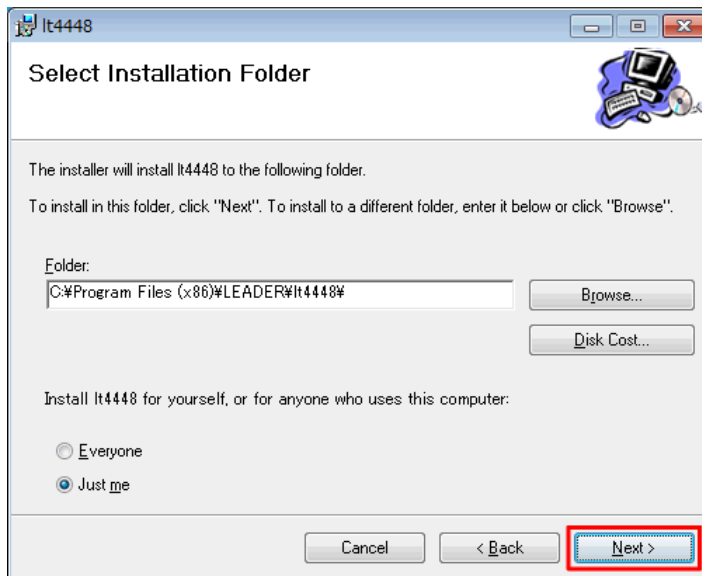

Figure 6-2 Installation 2

6. ETHERNET CONTROL

4. When the following window appears, click Next.

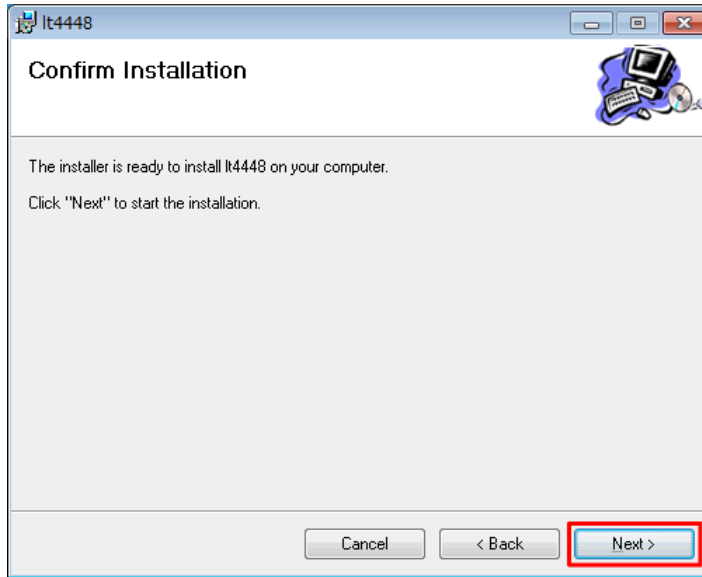

Figure 6-3 Installation 3

5. When the following window appears, the installation is complete. Click Close.

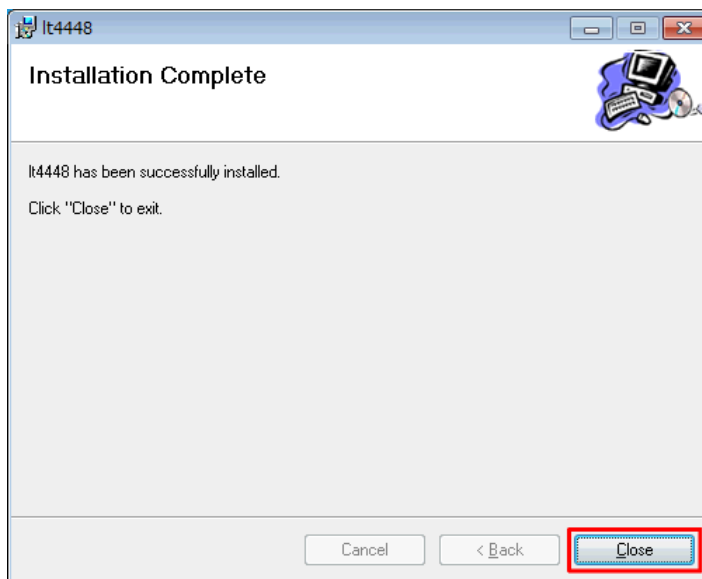

Figure 6-4 Installation 4

6. ETHERNET CONTROL

6.1.2 Uninstallation

To uninstall the software, select "It4448" in Programs and Features of Control Panel, and click Uninstall.

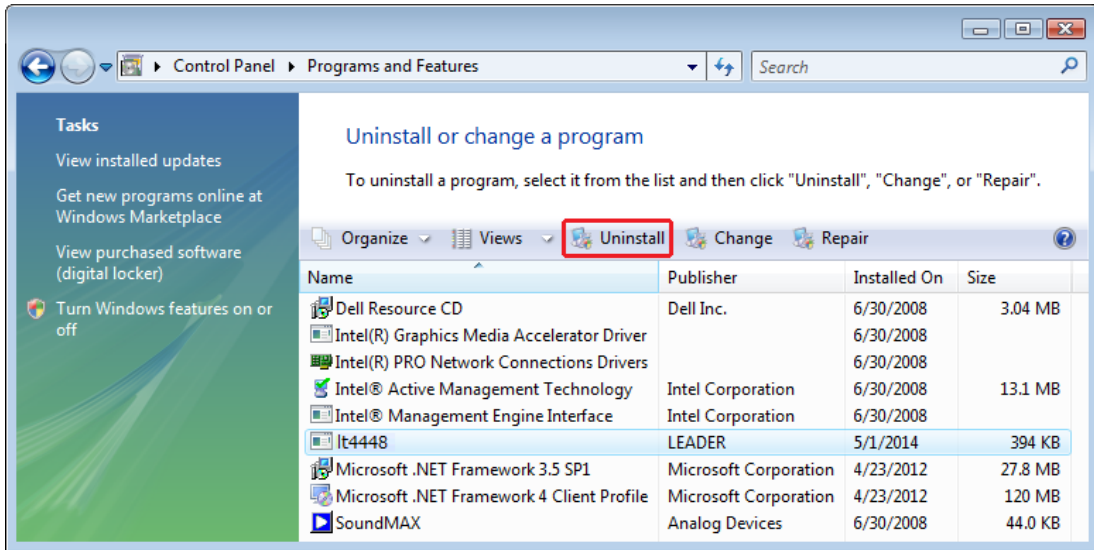

Figure 6-5 Uninstallation

6. ETHERNET CONTROL

6.1.3 Connection

To connect the LT 4448 to a PC, you must install a USB driver.
Install the VCP driver provided by FTDI in advance.

The latest USB driver can be downloaded from
<http://www.ftdichip.com/Drivers/VCP.htm>

This section describes the procedure to connect the LT 4448 to a PC and configure the LT 4448 network and SNMP settings.

1. Connect the USB port on the LT 4448 front panel to the PC's USB port.
Use a USB cable (A/B).
2. Start "LT4448 Setup" on the PC desktop.



3. From Device, select LT4448, select COM Port, and click Connect.

When the connection is established, the Connect button becomes unavailable, and GET and SUBMIT become available.

If you turn off the LT 4448 while a connection is established, the communication will be disconnected. If you do, restart the software and reconnect.

A screenshot of a Windows application window titled "LEADER LT4448 Network/SNMP Configuration". The window is divided into several sections: "Machine" with fields for Serial Number, FPGA Version, and MAC Address; "Date/Time" with dropdowns for YYYY/MM/DD (2017/05/10) and HH:MM:SS (14:00:23); "Software Version" with an empty text field; "Network" with fields for IP Address (192.168.0.1), Subnet Mask (255.255.255.0), and Default Gateway (0.0.0.0); "SNMP" with fields for SNMP Manager IP (0.0.0.0), Read Community (LDRUser), Write Community (LDRAdm), and Trap Community (LDRUser); "Configuration" with GET and SUBMIT buttons; "Update File" with an empty text field and Ref. and UPDATE buttons; and a bottom section with a Device dropdown (LT4448), a COM Port dropdown (COM3 USB Serial Port (COM3)), and a Connect button. The bottom section is highlighted with a red rectangle.

Figure 6-6 Connection

6. ETHERNET CONTROL

4. Enter the proper values in the Network and SNMP areas, and click SUBMIT.
5. When the following window appears, click OK.

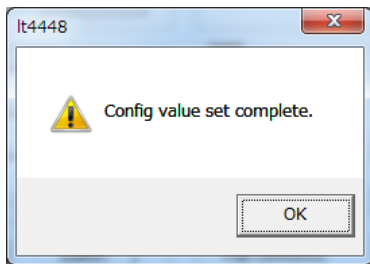

Figure 6-7 Configuration complete

6. Restart the LT 4448.

The network settings are applied after you restart the LT 4448.

6.1.4 Window Explanations

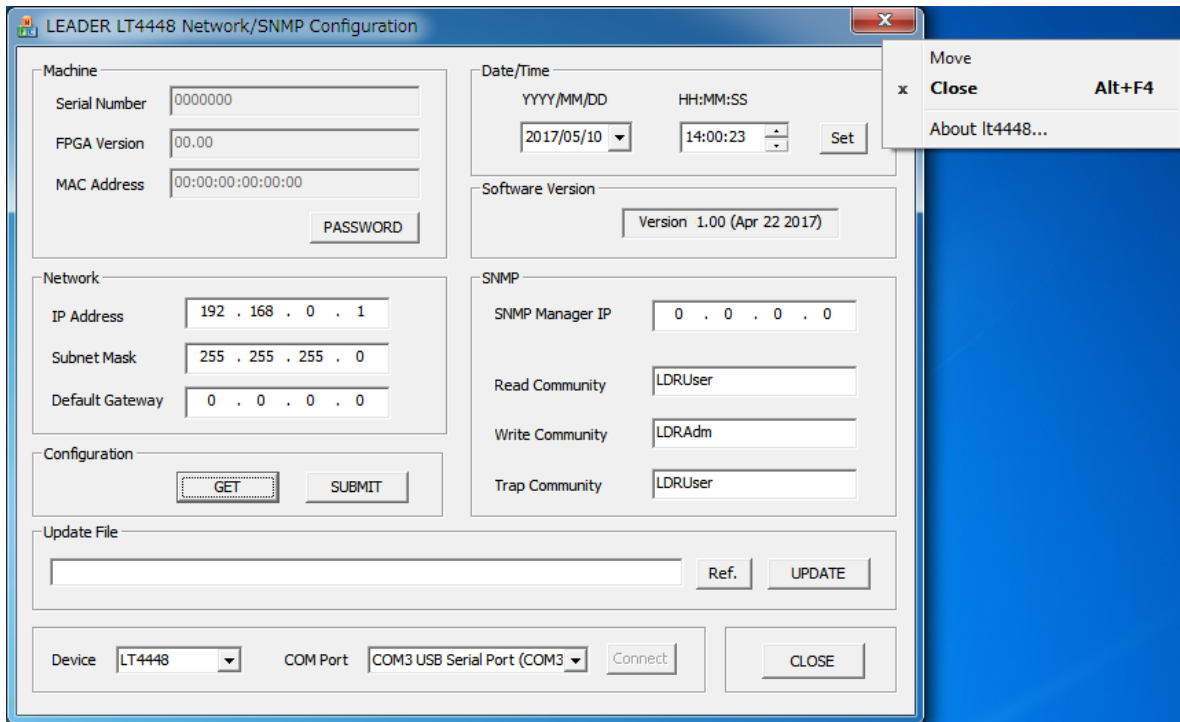

Figure 6-8 Window explanation

- About It4448

Right-click the title bar to use this command.
It displays the software version.

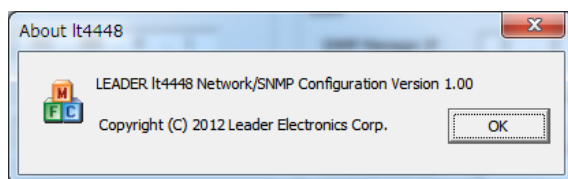

Figure 6-9 Software version

6. ETHERNET CONTROL

- Machine

Click GET to display the LT 4448 serial number, FPGA version, and MAC address. "PASSWORD" is not used.

- Network

Set the LT 4448's IP address, subnet mask, and default gateway. Enter these values, and then click SUBMIT. Pressing GET shows the values currently assigned to the LT 4448. These settings are applied after you restart the LT 4448.

By factory default, the following values are assigned to the LT 4448.

IP Address:	192.168.0.1
Subnet Mask:	255.255.255.0
Default Gateway:	0.0.0.0

- Date/Time

Set the date and time on the LT 4448. Enter the values, and then click Set.

- Software Version

Pressing GET shows the LT 4448 firmware version.

- SNMP

Set the IP address and community name of the TRAP transmission destination.

If you set the IP address to 0.0.0.0, traps will not be transmitted. The factory default setting is 0.0.0.0.

The factory default community names are shown below.

Read Community:	LDRUser
Write Community:	LDRAdm
Trap Community:	LDRUser

- Configuration

Click GET retrieves the current Machine, Network, Software Version, and SNMP values. Click SUBMIT to confirm the NETWORK and SNMP values. The network settings are applied after you restart the LT 4448.

- Update File

Not used.

- Device

Select the device that the PC will connect to. Select LT 4448.

- COM Port

Select the COM port that you want to connect the LT 4448 to.

- Connect

After setting Device and COM Port, click this to connect the PC to the LT 4448.

- CLOSE

Click CLOSE to close the software.

6. ETHERNET CONTROL

6.2 SNMP

By using SNMP (Simple Network Management Protocol), you can check the LT 4448 status from an SNMP manager. Additionally, you can notify the SNMP managers of errors that the LT 4448 generates.

6.2.1 SNMP Version

The LT 4448 supports SNMPv2c.

6.2.2 Control Items

The following items on the LT 4448 can be controlled.

Table 6-1 SNMP controls

	ACCESS MODE	Check the LT 4448 status	Change the LT 4448 settings	Retrieve LT 4448 errors
SNMP	Yes (*1)	Yes	Yes	Yes

*1 SNMP ACCESS MODE is always set to on, but you need to configure the Ethernet settings (IP address, subnet mask, gateway) for this to work. (If you set the IP address to 0.0.0.0, SNMP will not work.) In addition, SNMP traps will not be transmitted unless the SNMP Manager IP is set.

6.2.3 SMI Definitions

IMPORTS

MODULE-IDENTITY, OBJECT-TYPE, NOTIFICATION-TYPE, IPAddress, Counter32,
enterprises

FROM SNMPv2-SMI

DisplayString

FROM SNMPv2-TC

OBJECT-GROUP, MODULE-COMPLIANCE

FROM SNMPv2-CONF;

6.2.4 Notes on Updating

When the LT 4448 is being updated, the data in the system is overwritten. As such, the operation of all input signals and output signals including SNMP is not guaranteed.

Check with your system administrator when updating the LT 4448.

6.2.5 HOW TO USE

1. Configure the LT 4448.

From the software installed in your PC, set the IP address, subnet mask, default gateway, and SNMP manager IP.

The IP address of the TRAP transmission destination can also be set from an SNMP manager.

Reference 6.1, "SNMP Configuration Software"

2. Restart the LT 4448.

The IP address, subnet mask, and default gateway values take effect.

If you did not change these values in step 1, you do not need to restart the LT 4448.

3. Connect the LT 4448's Ethernet port to the network.

4. Start an SNMP manager.

You must provide the SNMP manager yourself.

The factory default community names are shown below.

Read Community: LDRUser

Write Community: LDRAdm

Trap Community: LDRUser

* The SNMP Community name can be changed with the SNMP configuration software or the HTTP server feature.

5. Set the SNMP manager's IP address.

1.3.6.1.4.1.leader(20111).lt4448(39).trap(100).target(1).trapManagerIp (1).0

* The SNMP manager's IP address can be changed with the SNMP configuration software or the HTTP server feature.

6. On the SNMP manager, enable the trap feature.

1.3.6.1.4.1.leader(20111).lt4448(39).trap(100).target(1).trapAction(2).0

* Enabling the TRAP feature can be changed with the SNMP configuration software.

7. Restart the LT 4448. Check that the standard TRAP "coldStart(0)" is received by the SNMP manager.

6.2.6 Enterprise MIB

● MIB Files

Download and unzip the Ver. 1.2 MIB file from our website, and use "LT4448-MIB.txt."
 However, if you are already using the Ver.1.0 MIB file, download the Ver. 1.0 MIB file.
 (User registration to my Leader is required.)

<https://www.leader.co.jp/en/support/download/lt4448/>

● MIB Structure

The LT 4448 MIB structure is shown below.

leader	OBJECT IDENTIFIER ::= { enterprises 20111 }
lt4448	OBJECT IDENTIFIER ::= { leader 39 }
notification	OBJECT IDENTIFIER ::= { lt4448 0 }
trapContent	OBJECT IDENTIFIER ::= { notification 1 }
error	OBJECT IDENTIFIER ::= { trapContent 1 }
normal	OBJECT IDENTIFIER ::= { trapContent 2 }
trapStr	OBJECT IDENTIFIER ::= { notification 2 }
standard	OBJECT IDENTIFIER ::= { lt4448 1 }
status	OBJECT IDENTIFIER ::= { standard 1 }
panel	OBJECT IDENTIFIER ::= { standard 2 }
remote	OBJECT IDENTIFIER ::= { standard 3 }
format	OBJECT IDENTIFIER ::= { standard 4 }
trap	OBJECT IDENTIFIER ::= { lt4448 100 }
target	OBJECT IDENTIFIER ::= { trap 1 }

6. ETHERNET CONTROL

- ACCESS

In the tables, "ACCESS" indicates the following:

- RO: Information that can be read from the SNMP managers
- WO: Information that can be written from the SNMP managers
- R/W: Information that can be read and written from the SNMP managers

- leader(20111).lt4448(39).standard(1).status(1)

Table 6-2 status (1).powerUnit1(2) group

MIB	OID	SYNTAX	ACCESS	VALUE	Description
power1Status	powerUnit1.1	INTEGER	RO	2	Stop
				3	Operation

Table 6-3 status (1). powerUnit2 (3) group

MIB	OID	SYNTAX	ACCESS	VALUE	Description
power2Status	powerUnit2.1	INTEGER	RO	2	Stop
				3	Operation

Table 6-4 status (1).ch1Status(4) group

MIB	OID	SYNTAX	ACCESS	VALUE	Description
ch1InputStatus	ch1Status.1	INTEGER	RO	1	Normal
				2	Error-Primary
				3	Error-Backup
				4	Error-Primary/Backup

Table 6-5 status (1).ch2Status(5) group

MIB	OID	SYNTAX	ACCESS	VALUE	Description
ch2InputStatus	ch2Status.1	INTEGER	RO	1	Normal
				2	Error-Primary
				3	Error-Backup
				4	Error-Primary/Backup

Table 6-6 status (1).ch3Status (6) group

MIB	OID	SYNTAX	ACCESS	VALUE	Description
ch3InputStatus	ch3Status.1	INTEGER	RO	1	Normal
				2	Error-Primary
				3	Error-Backup
				4	Error-Primary/Backup
ch3OutputStatus	ch3Status.2	INTEGER	RO	1	Normal
				2	Error-output

Table 6-7 status (1).ch4Status (7) group

MIB	OID	SYNTAX	ACCESS	VALUE	Description
ch4InputStatus	ch4Status.1	INTEGER	RO	1	Normal
				2	Error-Primary
				3	Error-Backup
				4	Error-Primary/Backup
ch4OutputStatus	ch4Status.2	INTEGER	RO	1	Normal
				2	Error-output

6. ETHERNET CONTROL

Table 6-8 status (1).ch5Status (8) group

MIB	OID	SYNTAX	ACCESS	VALUE	Description
Ch5InputStatus	Ch5Status.1	INTEGER	RO	1	Normal
				2	Error-Primary
				3	Error-Backup
				4	Error-Primary/Backup
Ch5OutputStatus	Ch5Status.2	INTEGER	RO	1	Normal
				2	Error-output

Table 6-9 status (1).ch6Status (9) group

MIB	OID	SYNTAX	ACCESS	VALUE	Description
ch6InputStatus	ch6Status.1	INTEGER	RO	1	Normal
				2	Error-Primary
				3	Error-Backup
				4	Error-Primary/Backup
ch6OutputStatus	ch6Status.2	INTEGER	RO	1	Normal
				2	Error-output

Table 6-10 status (1).ch7Status (10) group

MIB	OID	SYNTAX	ACCESS	VALUE	Description
ch7InputStatus	ch7Status.1	INTEGER	RO	1	Normal
				2	Error-Primary
				3	Error-Backup
				4	Error-Primary/Backup
ch7OutputStatus	ch7Status.2	INTEGER	RO	1	Normal
				2	Error-output

Table 6-11 status (1).ch8Status (11) group

MIB	OID	SYNTAX	ACCESS	VALUE	Description
ch8InputStatus	ch8Status.1	INTEGER	RO	1	Normal
				2	Error-Primary
				3	Error-Backup
				4	Error-Primary/Backup
ch8OutputStatus	ch8Status.2	INTEGER	RO	1	Normal
				2	Error-output

Table 6-12 status (1).ch9Status (12) group

MIB	OID	SYNTAX	ACCESS	VALUE	Description
ch9InputStatus	ch9Status.1	INTEGER	RO	1	Normal
				2	Error-Primary
				3	Error-Backup
				4	Error-Primary/Backup
ch9OutputStatus	ch9Status.2	INTEGER	RO	1	Normal
				2	Error-output

Table 6-13 status (1).ch10Status (13) group

MIB	OID	SYNTAX	ACCESS	VALUE	Description
ch10InputStatus	ch10Status.1	INTEGER	RO	1	Normal
				2	Error-Primary
				3	Error-Backup
				4	Error-Primary/Backup
ch10OutputStatus	ch10Status.2	INTEGER	RO	1	Normal
				2	Error-output

6. ETHERNET CONTROL

Table 6-14 status (1).ch11Status (14) group

MIB	OID	SYNTAX	ACCESS	VALUE	Description
ch11InputStatus	ch11Status.1	INTEGER	RO	1	Normal
				2	Error-Primary
				3	Error-Backup
				4	Error-Primary/Backup
ch11OutputStatus	ch11Status.2	INTEGER	RO	1	Normal
				2	Error-output

Table 6-15 status (1).ltcStatus (15) group

MIB	OID	SYNTAX	ACCESS	VALUE	Description
ltcInputStatus1	ltcStatus.1	INTEGER	RO	1	Normal
				2	Error-Primary
				3	Error-Backup
				4	Error-Primary-Backup

- leader(20111).lt4448(39).standard(1).panel(2)

Table 6-16 panel (2) group

MIB	OID	SYNTAX	ACCESS	VALUE	Description
panelKeyLock	panel.1	INTEGER	RO	1	ON
				2	OFF
panelFaultIndicator	panel.2	INTEGER	R/W	1	Normal
				2	Primary
				3	Backup
				4	Primary-Backup
panelAutoSwitching	panel.3	INTEGER	R/W	1	Auto-switching
				2	Disable
panelSyncSource	panel.4	INTEGER	R/W	1	Primary
				2	Backup
panelFaultReset	panel.5	INTEGER	WO	1	Reset
panelRemoteControl	Panel.6	INTEGER	R/W	1	Local
				2	Remote
panelActiveMode	Panel.7	INTEGER	R/W	1	Normal
				2	Override
panelWaitTime	Panel.8	INTEGER	R/W	1	Approximately 1 minute
				2	Approximately 2 minute
				3	Approximately 4 minute
				4	Not Delay
panelOutputAlarm	Panel.9	INTEGER	R/W	1	ON
				2	OFF

- leader(20111).lt4448(39).standard(1).remote(3)

Table 6-17 remote (3) group

MIB	OID	SYNTAX	ACCESS	VALUE	Description
remoteAutoSwitching	remote.1	INTEGER	RO	1	ON
				2	OFF
remoteSyncSource	remote.2	INTEGER	RO	1	ON
				2	OFF
remoteFaultReset	remote.3	INTEGER	RO	1	ON
				2	OFF
remoteFaultIndicator	remote.4	INTEGER	R/W	1	FAULT+ALARM
				2	FAULT Only

6. ETHERNET CONTROL

● leader(20111).lt4448(39).standard(1).format(4)

* The parameter priority is as follows: ch*FormatStatus1 > ch*FormatStatus2 > ch*FormatStatus3. (The asterisk represents Ch1 to 11.)

If the lower-priority-level setting is in conflict with a higher-priority-level setting, the setting is invalid.

Table 6-18 format(4).ch1Format(1) group

MIB	OID	SYNTAX	ACCESS	VALUE	Description
ch1FormatStatus1	ch1Format.1	INTEGER	R/W	1	Disable
				2	NTSC
				3	PAL
				4	720P
				5	1080I/P
				6	User Define 1
				7	User Define 2
				8	SD-SDI
				9	HD-SDI
				10	3G-SDI
ch1FormatStatus2	ch1Format.2	INTEGER	R/W	1	Disable
				2	High (60,59.94,50Hz)
				3	Low (30,29.97,25,24,23.98Hz)
ch1FormatStatus3	ch1Format.3	INTEGER	R/W	1	SLOW
ch1FormatStatus4	ch1Format.4	INTEGER	R/W	1	VREF-LOW
				2	VREF-HIGH

Table 6-19 format(4).ch2Format(2) group

MIB	OID	SYNTAX	ACCESS	VALUE	Description
ch2FormatStatus1	ch2Format.1	INTEGER	R/W	1	Disable
				2	NTSC
				3	PAL
				4	720P
				5	1080I/P
				6	User Define 1
				7	User Define 2
				8	SD-SDI
				9	HD-SDI
				10	3G-SDI
ch2FormatStatus2	ch2Format.2	INTEGER	R/W	1	Disable
				2	High (60,59.94,50Hz)
				3	Low (30,29.97,25,24,23.98Hz)
ch2FormatStatus3	ch2Format.3	INTEGER	R/W	1	SLOW
ch2FormatStatus4	ch2Format.4	INTEGER	R/W	1	VREF-LOW
				2	VREF-HIGH

6. ETHERNET CONTROL

Table 6-20 format(4).ch3Format(3) group

MIB	OID	SYNTAX	ACCESS	VALUE	Description
ch3FormatStatus1	ch3Format.1	INTEGER	R/W	1	Disable
				2	NTSC
				3	PAL
				4	720P
				5	1080I/P
				6	User Define 1
				7	User Define 2
ch3FormatStatus2	ch3Format.2	INTEGER	R/W	1	Disable
				2	High (60,59.94,50Hz)
				3	Low (30,29.97,25,24,23.98Hz)
ch3FormatStatus3	ch3Format.3	INTEGER	R/W	1	SLOW
				2	FAST
ch3FormatStatus4	ch3Format.4	INTEGER	R/W	1	VREF-LOW
				2	VREF-HIGH

Table 6-21 format(4).ch4Format(4) group

MIB	OID	SYNTAX	ACCESS	VALUE	Description
ch4FormatStatus1	ch4Format.1	INTEGER	R/W	1	Disable
				2	NTSC
				3	PAL
				4	720P
				5	1080I/P
				6	User Define 1
				7	User Define 2
ch4FormatStatus2	ch4Format.2	INTEGER	R/W	1	Disable
				2	High (60,59.94,50Hz)
				3	Low (30,29.97,25,24,23.98Hz)
ch4FormatStatus3	ch4Format.3	INTEGER	R/W	1	SLOW
				2	FAST
ch4FormatStatus4	ch4Format.4	INTEGER	R/W	1	VREF-LOW
				2	VREF-HIGH

Table 6-22 format(4).ch5Format(5) group

MIB	OID	SYNTAX	ACCESS	VALUE	Description
ch5FormatStatus1	ch5Format.1	INTEGER	R/W	1	Disable
				2	NTSC
				3	PAL
				4	720P
				5	1080I/P
				6	User Define 1
				7	User Define 2
ch5FormatStatus2	ch5Format.2	INTEGER	R/W	1	Disable
				2	High (60,59.94,50Hz)
				3	Low (30,29.97,25,24,23.98Hz)
ch5FormatStatus3	ch5Format.3	INTEGER	R/W	1	SLOW
				2	FAST
ch5FormatStatus4	ch5Format.4	INTEGER	R/W	1	VREF-LOW
				2	VREF-HIGH

6. ETHERNET CONTROL

Table 6-23 format(4).ch6Format(6) group

MIB	OID	SYNTAX	ACCESS	VALUE	Description
ch6FormatStatus1	ch6Format.1	INTEGER	R/W	1	Disable
				2	NTSC
				3	PAL
				4	720P
				5	1080I/P
				6	User Define 1
				7	User Define 2
ch6FormatStatus2	ch6Format.2	INTEGER	R/W	1	Disable
				2	High (60,59.94,50Hz)
				3	Low (30,29.97,25,24,23.98Hz)
ch6FormatStatus3	ch6Format.3	INTEGER	R/W	1	SLOW
				2	FAST
ch6FormatStatus4	ch6Format.4	INTEGER	R/W	1	VREF-LOW
				2	VREF-HIGH

Table 6-24 format(4).ch7Format(7) group

MIB	OID	SYNTAX	ACCESS	VALUE	Description
ch7FormatStatus1	ch7Format.1	INTEGER	R/W	1	Disable
				2	NTSC
				3	PAL
				4	720P
				5	1080I/P
				6	User Define 1
				7	User Define 2
ch7FormatStatus2	ch7Format.2	INTEGER	R/W	1	Disable
				2	High (60,59.94,50Hz)
				3	Low (30,29.97,25,24,23.98Hz)
ch7FormatStatus3	ch7Format.3	INTEGER	R/W	1	SLOW
				2	FAST
ch7FormatStatus4	ch7Format.4	INTEGER	R/W	1	VREF-LOW
				2	VREF-HIGH

Table 6-25 format(4).ch8Format(8) group

MIB	OID	SYNTAX	ACCESS	VALUE	Description
ch8FormatStatus1	ch8Format.1	INTEGER	R/W	1	Disable
				2	NTSC
				3	PAL
				4	720P
				5	1080I/P
				6	User Define 1
				7	User Define 2
ch8FormatStatus2	ch8Format.2	INTEGER	R/W	1	Disable
				2	High (60,59.94,50Hz)
				3	Low (30,29.97,25,24,23.98Hz)
ch8FormatStatus3	ch8Format.3	INTEGER	R/W	1	SLOW
				2	FAST
ch8FormatStatus4	ch8Format.4	INTEGER	R/W	1	VREF-LOW
				2	VREF-HIGH

6. ETHERNET CONTROL

Table 6-26 format(4).ch9Format(9) group

MIB	OID	SYNTAX	ACCESS	VALUE	Description
ch9FormatStatus1	ch9Format.1	INTEGER	R/W	1	Disable
				6	User Define 1
				7	User Define 2
				8	AES/EBU Digital Audio
ch9FormatStatus2	ch9Format.2	INTEGER	R/W	1	Disable
ch9FormatStatus3	ch9Format.3	INTEGER	R/W	1	SLOW
				2	FAST
ch9FormatStatus4	ch9Format.4	INTEGER	R/W	1	VREF-LOW
				2	VREF-HIGH

Table 6-27 format(4).ch10Format(10) group

MIB	OID	SYNTAX	ACCESS	VALUE	Description
ch10FormatStatus1	ch10Format.1	INTEGER	R/W	1	Disable
				6	User Define 1
				7	User Define 2
				8	AES/EBU Digital Audio
ch10FormatStatus2	ch10Format.2	INTEGER	R/W	1	Disable
ch10FormatStatus3	ch10Format.3	INTEGER	R/W	1	SLOW
				2	FAST
ch10FormatStatus4	ch10Format.4	INTEGER	R/W	1	VREF-LOW
				2	VREF-HIGH

Table 6-28 format(4).ch11Format(11) group

MIB	OID	SYNTAX	ACCESS	VALUE	Description
Ch11FormatStatus1	ch11Format.1	INTEGER	R/W	1	Disable
				6	User Define 1
				7	User Define 2
				8	Word Clock(TTL)
ch11FormatStatus2	ch11Format.2	INTEGER	R/W	1	Disable
ch11FormatStatus3	ch11Format.3	INTEGER	R/W	1	SLOW
				2	FAST
ch11FormatStatus4	ch11Format.4	INTEGER	R/W	1	VREF-LOW
				2	VREF-HIGH

Table 6-29 format(4).ltcFormat(12) group

MIB	OID	SYNTAX	ACCESS	VALUE	Description
ltcFormatStatus1	ltcFormat.1	INTEGER	R/W	1	ON
				2	OFF

● leader(20111).lt4448(39).trap(100) group

Table 6-30 target (3) group

MIB	OID	SYNTAX	ACCESS	VALUE	Description
managerIp	target.1	IP ADDRESS	R/W	*.*.*.*	Trap transmission destination
trapAction	target.2	INTEGER	R/W	1	Enable
				2	Disable

6.2.7 Extended TRAP (Variable Binding List)

● index 1

OID: iso(1).org(3).dod(6).internet(1).mib-2(1).system(1).sysUpTime(1).0

Syntax: TimeTicks

Range: 1 to 4294967295 (overflow occurs if this range is exceeded)

Description: Elapsed time after starting the SNMP agent

● index 2

OID: iso(1).org(3).dod(6).internet(1).snmpV2(6).snmpModules(3).
snmpMIB(1).snmpMIBObjects(1).snmpTrap(4).snmpTrapOID(1).0

Syntax: Object Identifier

Range: ---

Description: Trap identification field

● index 3

OID: leader(20111).lt4448(39).notification(0).trapStr(2).
trapCounter(1).0

Syntax: Counter32

Range: 1 to 4294967295

Description: The total number of enterprise traps sent after starting up

● index 4

OID: leader(20111).lt4448(39).notification(0).trapContent(1).error (1).X
leader(20111).lt4448(39).notification(0).trapContent(1).normal(2).X

Syntax: STRING

Range: Up to 16 characters

Description: Error information character string

The OID or trapContent(1).error(1).X and error information character string when an error occurs or

the OID of trapContent(1).normal(2).X and error information character string when the error recovers

are sent.

6. ETHERNET CONTROL

Table 6-31 Error information

Error Number (*1)	Error Information Character String	Description
5	powerUnit1Status	Detection of status change of power supply unit 1
6	powerUnit2Status	Detection of status change of power supply unit 2
7	ch1StatusInput	Detection of CH1 input status change
9	ch2StatusInput	Detection of CH2 input status change
11	ch3StatusInput	Detection of CH3 input status change
12	ch3StatusOutput	Detection of CH3 output status change
13	ch4StatusInput	Detection of CH4 input status change
14	ch4StatusOutput	Detection of CH4 output status change
15	ch5StatusInput	Detection of CH5 input status change
16	ch5StatusOutput	Detection of CH5 output status change
17	ch6StatusInput	Detection of CH6 input status change
18	ch6StatusOutput	Detection of CH6 output status change
19	ch7StatusInput	Detection of CH7 input status change
20	ch7StatusOutput	Detection of CH7 output status change
21	ch8StatusInput	Detection of CH8 input status change
22	ch8StatusOutput	Detection of CH8 output status change
23	ch9StatusInput	Detection of CH9 input status change
24	ch9StatusOutput	Detection of CH9 output status change
25	ch10StatusInput	Detection of CH10 input status change
26	ch10StatusOutput	Detection of CH10 output status change
27	ch11StatusInput	Detection of CH11 input status change
28	ch11StatusOutput	Detection of CH11 output status change
29	panelStatus	Detection of PANEL KEY status change
30	remoteStatus	Detection of REMOTE status change
31	ltcStatus	Detection of LTC status change

*1 OID number of error(1) and that of normal(2) of trapContent(1).

6.3 HTTP Server Feature

You can view and set the LT 4448 status from a general-purpose Web browser on a PC.

6.3.1 Operating Environment

- Supported OSs

PCs with the following OSs are supported.

- Windows Vista
- Windows 7
- Windows 8
- Windows 10

- Supported Browsers

The following browsers are supported.

- FireFox (latest)
- Google Chrome (latest)
- Microsoft Edge (latest)
- IE9 or later (IE9, IE10, and IE11)

6.3.2 Precautions

- The HTTP server feature only supports a single connection to a PC at any one time. Multiple simultaneous connections are not supported.

6. ETHERNET CONTROL

6.3.3 HOW TO USE

1. Configure the LT 4448.

From the software installed in your PC, set the IP address, subnet mask, and default gateway.

Reference 6.1, "SNMP Configuration Software"

2. Restart the LT 4448.

The IP address, subnet mask, and default gateway values take effect.

If you did not change these values in step 1, you do not need to restart the LT 4448.

3. Connect the LT 4448's Ethernet port to the network.

4. Start the web browser on your PC.

The HTTP server feature uses JavaScript.

Enable JavaScript in your web browser.

5. In the address box, enter "http://" and the IP address that you set in step 1.

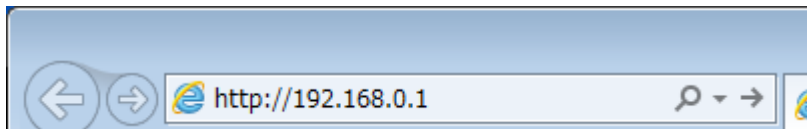
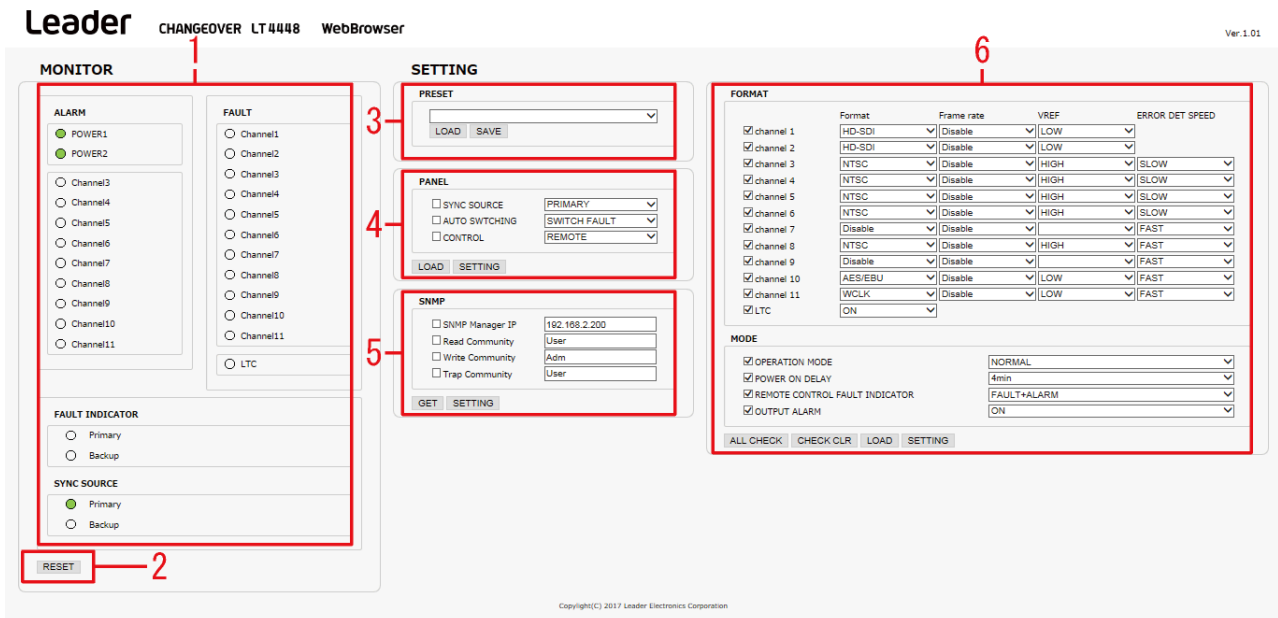

Figure 6-10 IP address input

6. A Web browser window appears.

You can view and set the LT 4448 status.



Copyright(C) 2017 Leader Electronics Corporation

Figure 6-11 Web browser window

6. ETHERNET CONTROL

Table 6-32 Web browser window explanation

Number	Name	Description
1	ALARM, FAULT, FAULT INDICATOR, SYNC SOURCE	Shows the alarm, fault, fault indicator, and sync source statuses.
2	RESET	Once an alarm and fault is detected, the alarm, fault, and fault indicator continue to light and blink even if the input signal returns to normal. To reset these indications, apply proper signals, and then click RESET. (*1)
3	PRESET	Loads and saves settings. Use the drop-down menu to select the preset of settings to load or save. (Preset 1 to 5) Click LOAD to load the selected preset into the Web browser. Click SAVE to save the Web browser settings to the selected preset. (*1) Simply clicking LOAD will not apply the settings to the device. Please check the items you want to change in FORMAT and MODE, and then click SETTING.
4	PANEL	When you click LOAD, the current sync source, auto switching, and control settings are displayed. To change the sync source, auto switching, or control setting, select the check box to the left of the item, select the appropriate value from the drop-down menu on the right, and click SETTING. (*1) When CONTROL is set to LOCAL, settings in your web browser will not be reflected. Setting it to REMOTE will enable your web browser settings.
5	SNMP	When you click GET, the current SNMP manager IP, read community, write community, and trap community settings are displayed. To change the SNMP manager IP, read community, write community, or trap community setting, select the check box to the left of the item, enter the setting in the box on the right, and click SETTING. (*1)
6	FORMAT, MODE	The top-panel DIP switch settings are changed from a Web browser. When you click LOAD, the current DIP switch settings are displayed. To change the DIP switch settings, select the check box to the left of the item, select the appropriate value from the drop-down menu on the right, and click SETTING. (*1) Clicking ALL SETS selects all the check boxes. Clicking CLEAR clears all the check boxes.

*1 An operation confirmation window appears to prevent mistakes. Clicking OK executes the operation.

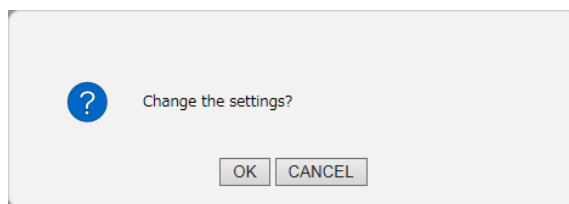

Figure 6-12 Operation confirmation

所含有毒有害物质信息

部件号码：LT4448



此标志适用于在中国销售的电子信息产品, 依据2016年1月6日公布的

《电器电子产品有害物质限制使用管理办法》以及SJ/T11364-2014《电器电子产品有害物质限制使用标识要求》，表示该产品在使用完结后可再利用。数字表示的是环境保护使用期限，只要遵守与本产品有关的安全和使用上的注意事项，从制造日算起在数字所表示的年限内，产品不会产生环境污染和对人体、财产的影响。

产品适当使用后报废的方法请遵从电子信息产品的回收、再利用相关法令。

详细请咨询各级政府主管部门。

产品中有毒有害物质或元素的名称及含量

部件名称 Parts	有毒有害物质或元素 Hazardous Substances in each Part					
	铅 (Pb)	汞 (Hg)	镉 (Cd)	六价铬 (Cr (VI))	多溴联苯 (PBB)	多溴二苯醚 (PBDE)
实装基板	×	○	○	○	○	○
主体部	×	○	○	○	○	○
开关电源	×	○	○	○	○	○
外筐	×	○	○	○	○	○
线材料一套	×	○	○	○	○	○
附件	×	○	○	○	○	○
包装材	○	○	○	○	○	○

备注)
○：表示该有毒有害物质在该部件所有均质材料中的含量均在GB/T26572规定的限量要求以下
×：表示该有毒有害物质或元素至少在该部件的某一均质材料中的含量超出GB/T26572标准规定的限量要求

Leader Electronics Corporation

2-6-33 Tsunashima-higashi, Kohoku-ku, Yokohama-shi,
Kanagawa, 223-8505, Japan
<https://leaderphabrix.com>