

Leader

LV5600 / LV7600

WAVEFORM MONITOR / RASTERIZER

LV5600-SER01	SDI INPUT
LV5600-SER02 / LV5600-SER02A	SDI INPUT / EYE
LV5600-SER03 / LV7600-SER03	DIGI / ANA AUDIO
LV5600-SER04 / LV7600-SER04	DOLBY
LV5600-SER05 / LV7600-SER05	10G IP INPUT
LV5600-SER06 / LV7600-SER06	25G IP INPUT
LV5600-SER23 / LV7600-SER23	HDR
LV5600-SER24 / LV7600-SER24	TSG
LV5600-SER25 / LV7600-SER25	FOCUS ASSIST
LV5600-SER26 / LV7600-SER26	LAYOUT
LV5600-SER27 / LV7600-SER27	TALLY
LV5600-SER28 / LV7600-SER28	4K
LV5600-SER29 / LV7600-SER29	12G-SDI
LV5600-SER30 / LV7600-SER30	VIDEO NOISE METER
LV5600-SER31 / LV7600-SER31	COLORIMETRY ZONE
LV5600-SER32 / LV7600-SER32	25G IP TSG
LV5600-SER40 / LV7600-SER40	EXTENDED VEC
LV5600-SER33 / LV7600-SER33	JPEG XS

Instruction Manual

Thank you for purchasing.

Please carefully read this instruction manual and the included "GENERAL SAFETY SUMMARY".

Please use the product safely.

TABLE OF CONTENTS

GENERAL SAFETY SUMMARY	I
1. INTRODUCTION.....	1
1.1 Scope of Warranty.....	1
1.2 Operating Precautions.....	1
1.2.1 Maximum Allowable Input Voltage.....	1
1.2.2 Mechanical Shock.....	2
1.2.3 Electrostatic Damage.....	2
1.2.4 Warming Up.....	2
1.2.5 About Standby Mode	2
1.2.6 Backup.....	2
1.2.7 About the LCD Panel (LV5600).....	2
1.3 About Trademarks and Licenses	3
1.4 Terminology Used in This Manual.....	3
2. PRODUCT CONFIGURATION.....	5
2.1 Lineup.....	5
2.2 Hardware Options	5
2.3 Software Options	6
2.4 Items Sold Separately.....	7
3. SPECIFICATIONS.....	8
3.1 General.....	8
3.2 Features	9
3.3 Specifications	13
3.3.1 SDI Video Formats and Standards (SER01/SER02/SER02A/SER28/SER29).....	13
3.3.2 IP Video Formats and Standards (SER05/SER06).....	21
3.3.3 JPEG XS Video Formats and Standards (SER33)	22
3.3.4 SDI Audio Formats and Standards (SER01/SER02/SER02A/SER03/SER04).....	23
3.3.5 IP Audio Formats and Standards (SER03/SER04/SER05/SER06)	23
3.3.6 External Digital I/O Audio Formats and Standards (SER03/SER04)	24
3.3.7 SDI Input Connector (SER01/SER02/SER02A/SER28/SER29)	24
3.3.8 SDI Output Connector (SER01/SER02/SER02A/SER24/SER28/SER29).....	24
3.3.9 IP Input/Output Connectors (SER05/SER06).....	25
3.3.10 External Reference Input.....	25
3.3.11 External Audio Input/Output Connectors (SER03/SER04)	26
3.3.12 Monitor Output Connector	26
3.3.13 Headphone Output.....	27
3.3.14 Control Connectors.....	27
3.3.15 Front Panel	29
3.3.16 Capturing	30
3.3.17 TSG (SER24/SER28/SER29)	31

3.3.18	25G IP TSG (SER06/SER32/SER33)	35
3.3.19	Presets	36
3.3.20	Display	36
3.3.21	Video Signal Waveform Display	38
3.3.22	Vector Display	40
3.3.23	Picture Screen	41
3.3.24	Colorimetry Zone Display (SER31)	42
3.3.25	Superimpose Display	42
3.3.26	CINELITE Display	44
3.3.27	CINELITE Advanced Display	45
3.3.28	CINEZONE Display	46
3.3.29	Focus Assist (SER25)	46
3.3.30	CIE Chromaticity Diagram Display	47
3.3.31	Video noise measurement (SER30)	48
3.3.32	HDR Display (SER23)	49
3.3.33	Audio Display	49
3.3.34	Status Display	54
3.3.35	Eye Pattern (SER02/SER02A)	63
3.3.36	Jitter Display (SER02/SER02A)	64
3.3.37	Tally Display	65
3.3.38	Camera ID Display	66
3.3.39	General Specifications	66
4.	PANEL DESCRIPTION	67
4.1	Front Panel	67
4.2	Rear Panel	71
5.	BEFORE YOU BEGIN MEASURING	74
5.1	Precautions When Installing the ZEN series	74
5.2	Attaching the Cover Inlet Stopper	76
5.3	Turning the Instrument On and Off	77
5.4	Connecting USB Devices	77
5.5	Installing the SFP+ Transceiver Module (SER05)	78
5.6	Installing the SFP+/SFP28 Transceiver Module (SER06)	79
5.7	Signal I/O	81
5.7.1	SDI Signal I/O	81
5.7.2	IP Signal Input/output (SER05/SER06)	83
5.7.3	External Sync Signal Input	85
5.7.4	Digital Audio I/O (SER03)	89
5.7.5	Analog Audio Signal I/O (SER03)	90
5.7.6	Monitor Signal Output	91
5.8	Operation Basics	92
5.8.1	Displaying the Function Menu	92
5.8.2	Function Menu Operations	92
5.8.3	Mouse and Touch Panel Control	93
5.8.4	Tab Menu Operations	95

5.8.5	Setting the Key Lock.....	96
5.9	Measurement Screen Description.....	97
6.	BASIC OPERATION	99
6.1	Setting the Input Signals.....	99
6.1.1	Selecting the Input Mode	99
6.1.2	Selecting the Simul Mode	100
6.1.3	Selecting the Displayed Channel.....	101
6.1.4	Input Format Error Indication	102
6.2	Setting the Signals to Measure	103
6.2.1	SD, HD, 3G-A, and 3G-B-DL Measurement	103
6.2.2	Measuring HD(DL) Signals.....	105
6.2.3	Measuring 3G(DL)-2K Signals	107
6.2.4	Measuring 3G-B DS Signals	109
6.2.5	Measuring 6G Signals (SER28/SER29).....	111
6.2.6	Measuring 12G Signals (SER28/SER29).....	113
6.2.7	Measuring 3G(QL) Signals (SER28).....	115
6.2.8	Measuring 3G(DL)-4K Signals (SER28).....	117
6.2.9	Measuring HD(QL) Signals (SER28)	119
6.2.10	IP Measurement (SER05/SER06).....	121
6.3	Selecting the Measurement Mode	124
6.3.1	Video Signal Waveform Display	124
6.3.2	Vector Display	125
6.3.3	Picture Screen	125
6.3.4	Audio Display	126
6.3.5	Status Display	126
6.3.6	Eye Pattern Display (SER02/SER02A).....	127
6.3.7	Multi Display	127
6.4	Operation Key Actions.....	131
6.5	Customized Layout (SER26)	133
6.5.1	Notes	133
6.5.2	Layout Procedure.....	134
6.5.3	Layout Screen Description	137
6.6	Enhanced Layout (SER26)	150
6.6.1	Enhanced Layout Procedure	151
6.6.2	Enhanced Layout Screen Description.....	155
7.	SYSTEM SETTINGS.....	161
7.1	Configuring the I/O Connectors.....	161
7.1.1	Configuring the Input System	161
7.1.2	Input Signal Assignment	164
7.1.3	Setting the Input Format.....	166
7.1.4	Setting the Payload ID	167
7.1.5	Setting the Format Alarm	169
7.1.6	Configuring the SDI Output Connectors.....	171
7.1.7	Configuring the TSG Settings (SER24).....	173

7.1.8	Configuring the Monitor Output Connectors	178
7.1.9	Configuring the HDR Settings (SER23)	179
7.1.10	Configuring the IP Signal Settings (SER05/SER06)	183
7.1.11	Configuring the PTP Settings (SER05/SER06)	188
7.1.12	Setting the Video Format (SER05/SER06)	189
7.1.13	Setting the IP TSG Output (SER32)	191
7.1.14	Setting the IP TSG Signal (SER32)	192
7.1.15	Setting the IP TSG Characters (SER32)	195
7.1.16	Setting the IP Parameters of the IP TSG Signal (SER32)	198
7.1.17	Setting the IP TSG Packet Emulation (SER32)	200
7.1.18	Configuring the NMOS Settings (SER05/SER06)	201
7.2	Configuring the Instrument	205
7.2.1	General Settings	205
7.2.2	Configuring the Function Menu	206
7.2.3	Configuring the On-screen Menu	207
7.2.4	Configuring the Capture Feature	208
7.2.5	Configuring the Information Display	210
7.2.6	Setting the Network IP	213
7.2.7	Configuring SNTP	214
7.2.8	Configuring the Server	215
7.2.9	Configuring SNMP	216
7.2.10	Configuring the IP Settings (SER05/SER06)	218
7.2.11	Configuring the Remote Control Settings	220
7.2.12	Configuring the RS-422/485 Settings (SER27)	222
7.2.13	Setting the Camera ID (SER27)	223
7.2.14	Configuring the Tally Display (SER27)	225
7.2.15	Setting the Operation keys	227
7.2.16	Date and time settings	229
7.2.17	Configuring the LV7290	230
7.3	Displaying System Information	232
7.4	Installing Software Options	233
7.5	Adjusting the Backlight (LV5600)	234
7.6	Turning Off the LCD Panel (LV5600)	234
7.7	Initialization	235
7.7.1	Initializing Settings	235
7.7.2	Initializing the Layout	236
7.7.3	Initializing the Operation keys	236
7.7.4	Initializing the Settings and Layout	236
8.	CAPTURE FEATURE	237
8.1	Screen Capture	238
8.1.1	Capturing the Displayed Screen	238
8.1.2	Displaying Screen Capture Data	238
8.1.3	Saving to a USB Memory Device	239
8.1.4	Displaying Screen Capture Data from a USB Memory Device	241
8.1.5	Deleting Screen Capture Data from a USB Memory Device	241
8.2	Frame Capture	243

8.2.1	Capturing Frame Data	243
8.2.2	Displaying Frame Capture Data	245
8.2.3	Saving to a USB Memory Device	246
8.2.4	Displaying Frame Data from a USB Memory Device.....	247
8.2.5	Deleting Frame Capture Data from a USB Memory Device.....	247
9.	PRESET FEATURE	248
9.1	Registering Presets	248
9.2	Loading Presets	250
9.3	Deleting Presets.....	251
9.4	Copying All Presets from the instrument to a USB Memory Device.....	252
9.5	Copying All Presets from a USB Memory Device to the instrument.....	253
10.	VIDEO SIGNAL WAVEFORM DISPLAY	254
10.1	Operation Key Description	254
10.2	Setting the Waveform Display Position.....	255
10.3	Configuring the Display Settings	256
10.3.1	Selecting the Display Mode.....	256
10.3.2	Turning the Channels On and Off.....	257
10.3.3	4Y Parade Display	258
10.3.4	Configuring the 3G-B DS Display	258
10.3.5	Adjusting the Waveform Intensity	258
10.3.6	Selecting the Waveform Color	259
10.3.7	Adjusting the Scale Intensity	259
10.3.8	Selecting the Scale Color.....	259
10.3.9	Selecting the Scale Unit	260
10.3.10	Displaying a Scale for 75% Color Bars.....	262
10.3.11	Displaying the Scale	263
10.4	Configuring the Gain and Filter Settings.....	264
10.4.1	Setting the Variable Gain.....	264
10.4.2	Selecting the Fixed Gain.....	264
10.4.3	Selecting the Filter	265
10.4.4	Setting the Scale Jump	268
10.5	Configuring the Sweep Settings.....	270
10.5.1	Selecting the Sweep Method.....	270
10.5.2	Selecting the Line Display Format.....	271
10.5.3	Selecting the Field Display Format	272
10.5.4	Selecting the Horizontal Magnification	273
10.5.5	Displaying the Blanking Interval	276
10.6	Configuring the Cursor Settings.....	277
10.6.1	Turning Cursors On and Off	277
10.6.2	Selecting the Cursor	277
10.6.3	Selecting the Y-Axis Measurement Unit	278
10.6.4	Selecting the X-Axis Measurement Unit	279
10.6.5	Moving the Cursors	279
10.6.6	Turning the Cursor Value Display On and Off.....	280

10.7	Configuring the Line Selection Settings.....	281
10.7.1	Turning Line Selection On and Off.....	281
10.7.2	Setting the Line Selection Range	282
10.8	Configuring the Color System Settings.....	283
10.8.1	Selecting the Color Matrix	283
10.8.2	Turning the Luminance Signal On and Off.....	285
10.8.3	Selecting the Composite Display Format.....	285
10.8.4	Selecting the Setup Level	286
10.9	Displaying the External Sync Signal Waveform.....	287
10.9.1	Adjusting the Waveform Intensity	287
10.9.2	Selecting the Waveform Color	287
10.9.3	Adjusting the Scale Intensity	287
10.9.4	Selecting the Scale Color.....	288
10.9.5	Selecting the Scale Unit	288
10.9.6	Displaying the Scale	288
11.	VECTOR DISPLAY	289
11.1	Operation Key Description	290
11.2	Setting the Display and Waveform Intensity	291
11.2.1	Switching the Display Mode	291
11.2.2	Selecting the Vector Mode (SER40).....	292
11.2.3	Adjusting the Waveform Intensity	294
11.2.4	Selecting the Waveform Color	294
11.2.5	Configuring the 3G-B DS Display	295
11.3	Setting the Vector Scale	296
11.3.1	Adjusting the Scale Intensity	296
11.3.2	Selecting the Scale Color.....	296
11.3.3	Turning the Color Wheel On and Off.....	296
11.3.4	ARIB Check Marker	297
11.3.5	Turning the I and Q Axes On and Off	298
11.3.6	Selecting the Scale.....	299
11.3.7	Turning the Variable Scale On and Off	299
11.4	Setting the RGB Vector Scale (SER40)	300
11.4.1	Adjusting the Scale Intensity	300
11.4.2	Selecting the Scale Color.....	300
11.4.3	Selecting the Adjust Target.....	300
11.4.4	Adjusting the G-B H / G-R H.....	300
11.4.5	Adjusting the G-B V / G-R V	300
11.5	Setting the YCbCr Vector Scale (SER40)	301
11.5.1	Adjusting the Scale Intensity	301
11.5.2	Selecting the Scale Color.....	301
11.5.3	Selecting the Timing Marker	301
11.5.4	Selecting the YCbCr Vector Scale.....	301
11.6	Setting the Vector Gain	302
11.6.1	Setting the Variable Gain.....	302
11.6.2	Selecting the Fixed Gain.....	303
11.6.3	Turning the Guide Display On and Off	303

11.7	Setting the RGB Vector Gain	304
11.7.1	Adjusting the Gain H	304
11.7.2	Adjusting the Gain V.....	304
11.8	Setting the YCbCr Vector Gain.....	305
11.8.1	Setting the Variable Gain.....	305
11.8.2	Selecting the Fixed Gain.....	305
11.8.3	Selecting the Observation Point.....	305
11.9	Configuring the Marker Settings	306
11.9.1	Displaying the Vector Marker	306
11.9.2	Configuring the Variable Marker	307
11.10	Configuring the Line Selection Settings.....	308
11.10.1	Turning Line Selection On and Off.....	308
11.10.2	Setting the Line Selection Range	309
11.11	Configuring the Color System Settings.....	310
11.11.1	Selecting the Color Matrix	310
11.11.2	Displaying a Scale for 75% Color Bars.....	311
11.11.3	Selecting the Composite Display Format.....	312
11.11.4	Selecting the Setup Level	313
11.12	5-Bar Display.....	314
11.12.1	Selecting the Scale Unit	315
11.12.2	Selecting the Display Order	317
11.13	Histogram Display	318
11.13.1	Selecting the Display Format	318
11.13.2	Selecting the Measurement Signal	320
12.	CIE CHROMATICITY DIAGRAM DISPLAY	321
12.1	Setting the Scale.....	321
12.1.1	Selecting the Color Scale.....	322
12.1.2	Selecting the Triangle	323
12.1.3	Setting the User-defined Triangle	324
12.1.4	Turning the Sub Scale On and Off.....	326
12.2	Setting the Chromaticity Diagram Mode.....	327
12.2.1	Selecting the Display Mode.....	327
12.2.2	Selecting the Display Standard.....	327
12.2.3	Turning Clipping On and Off.....	328
12.2.4	Turning the Filter On and Off	328
12.2.5	Setting the Gamma Value.....	328
12.3	Displaying Cursors.....	329
12.4	Configuring the Line Selection Settings.....	329
13.	PICTURE DISPLAY	330
13.1	Selecting the Display Mode	331
13.2	Adjusting the Picture	332
13.2.1	Switching between the Color and Monochrome Displays	332
13.2.2	Setting the Chroma Gain.....	332
13.2.3	Adjusting the Brightness	332

13.2.4	Adjusting the Contrast	332
13.2.5	Adjusting the Gain	333
13.2.6	Adjusting the Bias	333
13.3	Configuring the Display Settings	334
13.3.1	Displaying Gamut Errors	334
13.3.2	Displaying COLORIMETRY ZONE (SER31)	335
13.3.3	Turning the Information On and Off	337
13.3.4	Configuring the SCTE-104 Detection Display settings	338
13.3.5	Displaying the SCTE-104 Detection screen.....	339
13.3.6	Configuring the 3G-B DS Display Setting	341
13.4	Configuring the Marker Settings	342
13.4.1	Turning the Frame Marker On and Off	342
13.4.2	Turning the Center Marker On and Off.....	342
13.4.3	Setting the Aspect Marker	343
13.4.4	Setting the Aspect Shadow.....	345
13.4.5	Setting the Safe Action Marker.....	346
13.4.6	Setting the Safe Title Marker	346
13.4.7	Setting User Markers	347
13.5	Setting the Superimpose Feature.....	348
13.5.1	Selecting the Closed Caption Display.....	348
13.5.2	Selecting the Format of English Closed Captions	348
13.5.3	Selecting the Display Details of English Closed Captions.....	349
13.5.4	Selecting the Format of Japanese Closed Captions	349
13.5.5	Selecting the Japanese Closed Caption Data	349
13.5.6	Displaying the Clear Screen Log	350
13.5.7	Clearing Japanese Closed Caption Data	355
13.5.8	Selecting the Multiplex System for European Closed Captions	356
13.5.9	Selecting the Magazine Number and Page Number for European Closed Captions.....	356
13.6	Configuring CINELITE Settings	357
13.6.1	f Stop Display Description	358
13.6.2	Procedure for Displaying the f Stop Display	359
13.6.3	%DISPLAY Screen Description	360
13.6.4	Selecting the Points to Display	362
13.6.5	Setting Measurement Points	362
13.6.6	Setting the Measurement Size.....	362
13.6.7	Configuring User-Defined Correction Tables	363
13.6.8	Displaying Link Markers	368
13.7	Configuring CINEZONE Settings.....	369
13.7.1	Gradation Display Mode	369
13.7.2	Step Display Mode	370
13.7.3	Search Display Mode	372
13.8	Configuring %DISPLAY & CINEZONE Settings	373
13.9	Focus Assist Display (SER25)	374
13.9.1	Selecting the Display Mode.....	374
13.9.2	Turning Focus Assist On and Off	374
13.9.3	Selecting the Detection Sensitivity	375
13.9.4	Selecting the Luminance Level	375

13.9.5	Selecting the Highlight Color.....	375
13.10	Configuring the Line Selection Settings.....	376
13.10.1	Turning Line Selection On and Off.....	376
13.10.2	Setting the Line Selection Range	377
13.10.3	Setting the Lip Sync Measurement Range (SER03).....	377
13.11	Video noise measurement (SER30).....	378
13.11.1	Turning the Video Noise Measurement On and Off	378
13.11.2	Configuring the Measurement Window	379
13.11.3	Selecting the Measurement Signal	380
13.11.4	Selecting the Filter	380
13.11.5	Selecting the Measurement Result Display Size.....	380
13.11.6	Turning the Alarm Function On and Off	381
13.11.7	Setting the Threshold of the Alarm Function	381
13.11.8	Turning the Level Bar Display On and Off.....	382
14.	HDR DISPLAY (SER23).....	383
14.1	Video Signal Waveform Display	385
14.1.1	Scale Display	385
14.1.2	Selecting the Scale Display	391
14.1.3	Setting the Reference Level	392
14.1.4	Cursor Display	393
14.2	Vector Display.....	394
14.2.1	HDR Mode Display.....	394
14.2.2	Histogram Display	395
14.3	Picture Screen	396
14.3.1	CINELITE and CINEZONE Displays.....	396
14.3.2	%DISPLAY	399
14.3.3	CINEZONE Display	400
14.3.4	Link Marker Display	401
14.4	MAX FALL and MAX CLL Displays	402
14.4.1	Turning the Display On and Off	402
14.4.2	Starting and Stopping Measurements.....	402
14.4.3	Clearing Measurements.....	402
14.4.4	Setting the MAX FALL/CLL Error	403
15.	AUDIO DISPLAY	405
15.1	Setting the Signals to Measure	407
15.1.1	Selecting the Measurement Signal	407
15.1.2	Channel Assignment for the Lissajous Display (SER03)	412
15.1.3	Channel Assignment for the Surround Display (SER03).....	412
15.1.4	Configuring the Dolby Settings (SER04)	413
15.1.5	Configuring Audio Input/Output Connectors (SER03)	414
15.1.6	Channel Assignment for the Analog Audio Output Connector (SER03).....	415
15.1.7	Labeling IP signals (SER06)	416
15.2	Selecting the Display Mode (SER03).....	418
15.3	Configuring Error Detection Settings	421

15.4	Adjusting the Volume.....	422
15.5	Meter Display	423
15.5.1	Selecting the Scale.....	423
15.5.2	Selecting the Response Model.....	424
15.5.3	Setting the Peak Hold	424
15.5.4	Setting the Reference Level	425
15.5.5	Configuring the Numeric Display	426
15.5.6	Resetting the Peak Hold	426
15.6	Lissajous Display (SER03)	427
15.6.1	Adjusting the Lissajous Curve Intensity.....	427
15.6.2	Adjusting the Scale Intensity	427
15.6.3	Selecting the Lissajous Curve Display Format.....	428
15.6.4	Selecting the Scale Display Format	429
15.6.5	Setting the Lissajous Curve Gain	430
15.7	Surround Display (SER03)	431
15.7.1	Adjusting the Surround Waveform Intensity.....	431
15.7.2	Adjusting the Scale Intensity	431
15.7.3	Selecting the Surround Display Format.....	432
15.7.4	Setting the Surround Waveform Gain	432
15.8	Status Display (SER03)	433
15.8.1	Status Screen Description	433
15.8.2	Event Log Display	435
15.8.3	Metadata Display (SER04).....	436
15.8.4	Channel Status Display	440
15.8.5	Displaying User Bits.....	441
15.8.6	Resetting Errors.....	441
15.9	Loudness Display (SER03)	442
15.9.1	Loudness Display Explanation	442
15.9.2	Selecting the Measurement Time.....	445
15.9.3	Clearing the Loudness Measurement.....	445
15.9.4	Starting and Stopping Measurements.....	445
15.9.5	Selecting the Scale.....	445
15.9.6	Configuring Loudness Settings	446
15.9.7	Saving to a USB Memory Device	453
16.	STATUS DISPLAY.....	457
16.1	Status Screen Description.....	457
16.2	Configuring Error Detection Settings	462
16.2.1	Error Setup 1	462
16.2.2	Error Setup 2	465
16.2.3	Error Setup 3	466
16.2.4	Error Setup 4	469
16.2.5	Error Setup 5 (SER05/SER06).....	472
16.3	Clearing Error Counts.....	477
16.4	Configuring Event Log Settings.....	477
16.4.1	Event Log Screen Description	478
16.4.2	Starting the Event Log	483

16.4.3	Clearing the Event Log.....	483
16.4.4	Selecting the Overwrite Mode	483
16.4.5	Saving to a USB Memory Device	484
16.5	Configuring the Data Dump Settings	486
16.5.1	Data Dump Display Description	487
16.5.2	Moving the Display Position	488
16.5.3	Selecting the Adjustment Step Resolution.....	489
16.5.4	Selecting What the Function Dial Controls.....	489
16.5.5	Selecting the Display Mode.....	489
16.5.6	Selecting the Display Format	490
16.5.7	Selecting the Content to Display.....	492
16.5.8	Saving to a USB Memory Device	492
16.6	Configuring Phase Difference Measurement Settings	493
16.6.1	Phase Difference Measurement Screen Description	494
16.7	Setting the Lip Sync Measurement (SER03)	499
16.7.1	Selecting the Measurement Range.....	500
16.7.2	Updating the Measurement Screen	500
16.7.3	Setting the Measurement Range	501
16.8	Configuring the IP Screen (SER05/SER06)	504
16.8.1	Displaying the IP Status Screen.....	504
16.8.2	Configuring the IP Status Screen	506
16.8.3	Displaying the Packet Jitter Screen	507
16.8.4	Configuring the Packet Jitter Screen.....	509
16.8.5	Displaying the PTP Status Screen	510
16.8.6	Configuring the PTP Status Screen	514
16.8.7	Displaying the PTP Timing Comparison Screen	515
16.8.8	Configuring the PTP Timing Comparison Screen	516
16.8.9	Displaying the Path Delay Screen	517
16.8.10	Configuring the Path Delay Screen.....	517
16.8.11	Displaying and Configuring the SFP Information screen	518
16.8.12	Displaying the Packet Header Screen	519
16.8.13	Configuring the Packet Header Screen.....	521
16.8.14	Displaying the Buffer Screen (SER06)	522
16.8.15	Configuring the Buffer Screen (SER06).....	524
16.8.16	Displaying the NMOS Screen.....	525
16.8.17	Configuring the NMOS Screen	529
16.8.18	Displaying and Configuring the JPEG XS Status Screen (SER33).....	531
16.8.19	Displaying and Configuring the JPEG XS Header Screen (SER33).....	533
16.8.20	Displaying the Format Comparison Screen (SER33)	541
16.8.21	Configuring the Chart Setup Menu	542
16.8.22	Configuring the Stream Setup Menu	545
16.9	Displaying a List of Ancillary Data	546
16.9.1	Ancillary Data Display Description.....	546
16.9.2	Displaying a Dump of Ancillary Data	547
16.9.3	Updating the Dump Display	547
16.9.4	Selecting the Dump Mode	548
16.10	Detecting Ancillary Packets	549

16.10.1	Ancillary Packet Screen Description.....	549
16.10.2	Displaying EDH Packets.....	551
16.10.3	Displaying Payload IDs.....	551
16.10.4	Displaying Audio Control Packets	553
16.10.5	V-ANC ARIB Display	554
16.10.6	Displaying Closed Caption Packets	554
16.10.7	Displaying the Inter-Stationary Control Signal	555
16.10.8	Displaying the Data Broadcast Trigger Signal	558
16.10.9	Displaying User Data	559
16.10.10	V-ANC SMPTE Display	559
16.10.11	Displaying EIA-708 Data	560
16.10.12	Displaying EIA-608 Data	561
16.10.13	Displaying Program Data.....	562
16.10.14	Displaying VBI Data	563
16.10.15	Displaying AFD Packets.....	564
16.10.16	Configuring the SCTE-104 Detection Display settings	565
16.10.17	Displaying the SCTE-104 Detection screen.....	567
16.10.18	Displaying SR Live Packets	569
16.10.19	Performing Custom Searches.....	570
17.	EYE PATTERN DISPLAY (SER02/SER02A)	572
17.1	Eye Pattern Display Description	574
17.2	Jitter Display Description	576
17.3	Setting the Waveform Display Position.....	577
17.4	Switching between Eye Pattern and Jitter	577
17.5	Turning the Histogram Display On and Off	578
17.6	Setting the Intensity	579
17.6.1	Adjusting the Waveform Intensity	579
17.6.2	Adjusting the Histogram Intensity	579
17.6.3	Adjusting the Scale Intensity	579
17.7	Selecting the Display Colors.....	580
17.7.1	Selecting the Waveform Color.....	580
17.7.2	Selecting the Histogram Color.....	580
17.7.3	Selecting the Scale Color.....	580
17.8	Configuring Error Detection Settings	581
17.8.1	Configuring 12G Error Settings.....	581
17.8.2	Configuring 6G Error Settings	583
17.8.3	Configuring 3G Error Settings	585
17.8.4	Configuring HD Error Settings.....	587
17.8.5	Configuring SD Error Settings	589
17.9	Configuring Eye Pattern Display Settings.....	591
17.9.1	Adjusting the Gain	591
17.9.2	Selecting the Filter	591
17.9.3	Selecting the Sweep Time	592
17.9.4	Turning the Peak Hold On and Off.....	593
17.9.5	Clearing the Peak Hold.....	593
17.9.6	Turning Cursors On and Off	594

17.9.7	Selecting the Cursor	595
17.9.8	Selecting the X-Axis Measurement Unit	597
17.9.9	Selecting the Y-Axis Measurement Unit	597
17.9.10	Moving the Cursors	597
17.9.11	Resetting Cursors.....	598
17.9.12	Selecting the Display Mode.....	598
17.9.13	Selecting the 2-Screen Display Mode	598
17.10	Configuring the Jitter Display Settings	598
17.10.1	Selecting the Magnification	599
17.10.2	Selecting the Filter	599
17.10.3	Selecting the Sweep Time	599
17.10.4	Turning the Peak Hold On and Off.....	600
17.10.5	Clearing the Peak Hold.....	600
17.10.6	Turning Cursors On and Off	601
17.10.7	Selecting the Cursor	601
17.10.8	Selecting the X-Axis Measurement Unit	602
17.10.9	Selecting the Y-Axis Measurement Unit	602
17.10.10	Moving the Cursors	602
17.10.11	Resetting Cursors.....	603
17.10.12	Selecting the Display Mode.....	603
17.10.13	Selecting the 2-Screen Display Mode	603
18.	REMOTE CONTROL	604
18.1	Bit Mode	605
18.2	Binary Mode	608
18.3	Command Mode.....	610
18.4	Tally Mode (SER27)	612
19.	RS-422/485 (SER27)	614
19.1	Leader's Standard Protocol	616
19.1.1	Connection Example	616
19.1.2	Transmission Commands.....	616
19.1.3	Response Messages.....	624
19.2	TSL Protocol	625
19.2.1	Connection Example	625
19.2.2	UMD V3.1 Packet Format	625
19.2.3	UMD V4.0 Packet Format	626
20.	NETWORK CONTROL	627
20.1	SNTP Client Function	627
20.1.1	How to Use	627
20.1.2	Time Adjustment Value.....	628
20.2	TELNET	629
20.2.1	How to Use	629
20.2.2	How to Enter Commands	630
20.2.3	TELNET Commands.....	631

20.3	FTP	656
20.3.1	How to Use	656
20.3.2	How to Enter Commands	657
20.3.3	FTP Commands	657
20.4	HTTP.....	658
20.4.1	Operating Environment.....	658
20.4.2	Notes	659
20.4.3	How to Use	659
20.4.4	MEASUREMENT WITH DISPLAY	661
20.4.5	REMOTE CONTROL.....	662
20.4.6	EVENT LOG VIEWER.....	663
20.5	SNMP	664
20.5.1	SMI Definitions	664
20.5.2	How to Use	664
20.5.3	Standard MIBs.....	666
20.5.4	Enterprise MIB.....	670
20.5.5	Extended TRAP (Variable Binding List)	731
21.	MENU TREE	746
21.1	INPUT Menu	746
21.2	SYS Menu	747
21.3	CAP Menu	751
21.4	MEM Menu	753
21.5	RECALL Menu	754
21.6	WFM Menu	755
21.7	VECT Menu	758
21.8	PIC Menu	765
21.9	AUDIO Menu	771
21.10	STATUS Menu	775
21.11	EYE Menu (SER02/SER02A).....	785
21.12	MULTI Menu	787
22.	FIRMWARE UPDATE HISTORY	788

GENERAL SAFETY SUMMARY

- Read This before Using the Instrument

This instrument should only be used by persons with sufficient knowledge of electronics who thoroughly understand the contents of this manual.



This instrument is not designed or manufactured for households or ordinary consumers. If unqualified personnel are to use the instrument, be sure the instrument is handled under the supervision of qualified personnel (those who have electrical knowledge). This is to prevent the possibility of personal injury or damage to the instrument.

- Note about Reading This Manual

The contents of this manual contain specialized terminology and may be difficult to understand. If you have any questions about the contents of this manual, please contact your local LEADER agent.

- Symbols and Terms

The following symbols and terms are used in this instruction manual and on the instrument to indicate important warnings and notes.

<p><Symbol></p> 	<p>This symbol appears in this instruction manual and on the instrument to indicate an area where improper handling could result in personal injury, damage to the instrument, or malfunction of the instrument or devices connected to it.</p> <p>When you encounter this symbol on the instrument, be sure to refer to the information in this instruction manual that corresponds to the area that the symbol marks.</p>
<p><Term></p> 	<p>Ignoring the precautions that this term indicates could lead to death or serious injury.</p>
<p><Term></p> 	<p>Ignoring the precautions that this term indicates could lead to personal injury or damage to the instrument.</p>

GENERAL SAFETY SUMMARY

Read the warnings and information below thoroughly to avoid death, personal injury, and damage and deterioration of the instrument.



■ Warnings Concerning the Case and Panels

Do not remove the instrument's case or panels for any reason. Touching the internal components of the instrument could lead to fire or electric shock.

Also, do not allow foreign materials, such as liquids, combustible matter, and metal, to enter the instrument. Turning the instrument on when such materials are inside it could lead to fire, electric shock, damage to the instrument, or some other accident.

■ Installation Environment

• Operating Temperature Range

Use this instrument in a 0 to 40 °C environment. Using the instrument with its vents blocked or in a high temperature environment could lead to fire.

Drastic changes in temperature, such as might be caused by moving the instrument between two rooms with different temperatures, can damage the instrument by causing condensation to form within it. If there is a possibility that the instrument has condensation within it, wait for approximately 30 minutes before turning on the power.

• Operating Humidity Range

Use this instrument in an environment whose relative humidity is 85 % or less where there is no threat of condensation forming.

Also, do not operate this instrument with wet hands. Doing so could lead to electric shock or fire.

• Do Not Operate in an Explosive Atmosphere

Using this instrument in an environment where flammable gases, explosive gases, or steam is emitted or stored could lead to an explosion or fire. Do not use the instrument in such an environment.

• Do Not Insert Foreign Materials

Do not insert foreign materials, such as metal and flammable objects, through the vents or allow liquid to enter the instrument. Such acts can lead to fire, electric shock, damage to the instrument, or some other accident.

■ If You Notice Something Wrong during Operation

If you notice smoke, fire, a strange smell, or something else that is wrong with the instrument while you are operating it, stop operation immediately. Failing to do so could lead to fire. Turn OFF the power switch, and remove the power cord from the outlet. After making sure that fire has not spread anywhere, contact your local LEADER agent.

GENERAL SAFETY SUMMARY



■ Warnings Concerning the Power Source

Do not use a power source with a voltage other than the rated power source voltage for the instrument. Doing so could lead to fire.

Confirm the voltage of the power source before you connect the power cord to it.

Only use a power source whose frequency is 50/60 Hz.

Use a power cord that is appropriate for the voltage of the power source. Also, use a power cord that meets the safety standards of the country that you are using it in.

Using a power cord that does not meet the standards could lead to fire. If the power cord is damaged, stop using it, and contact your local LEADER agent. Using a damaged power cord could lead to electrical shock or fire.

When removing the power cord from the power outlet, do not pull on the cord. Pull from the plug.

■ Warnings Concerning Grounding

The instrument has a ground terminal to protect the user and the instrument from electric shock. Ensure that the product is properly grounded for safe operation.

■ Warnings Concerning the Panel

Sections of the panel are made out of glass. If the glass breaks, the broken glass may lead to injury. Do not apply a strong shock to the panel, cut it with sharp metal, or damage it in any similar manner.



■ Cautions Concerning the Input and Output Connectors

To avoid damaging the instrument, only apply signals to the input connectors that conform to the specifications in this instruction manual. Do not short or apply external voltage to the output connectors. Doing so could damage the instrument.

■ Cautions Concerning the Ethernet Port

When you are connecting the instrument to the communication provider's equipment, connect to the Ethernet port through a hub that is authorized for use in the country that you are using the instrument in.

GENERAL SAFETY SUMMARY

■ Calibration and Repairs

This instrument has been carefully examined at the factory to ensure that its performance is in accordance with the standards. However, because of factors such as parts wearing out over time, the performance of the instrument may degrade. To ensure stable performance, we recommend that you have the instrument calibrated regularly. Also, if the instrument malfunctions, repairs are necessary. For repairs and calibration, contact your local LEADER agent.

■ Routine Maintenance

When you clean the instrument, remove the power plug from the outlet.

Do not use thinner or benzene when you clean the instrument's case, panels, or knobs. Doing so could lead to paint chipping and the corrosion of plastic components. To clean the case, panels, and knobs, use a soft cloth with mild detergent, and wipe gently. While cleaning, make sure that foreign materials, such as water and detergent, do not enter the product. If liquid or a metal object enters into the instrument, fire or electric shock may result.

■ About the European WEEE Directive

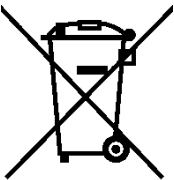

This instrument and its accessories are subject to the European WEEE Directive. Follow the applicable regulations of your country or region when discarding this instrument or its accessories. Follow the EU Battery Directive when discarding the batteries that you removed from this instrument.



(WEEE stands for Waste Electrical and Electronic Equipment.)

Follow the warnings and precautions that have been listed in this section to use the instrument correctly and safely. Precautions are also contained in various other sections of this instruction manual. To use the instrument correctly, be sure to follow those precautions as well.

If you have any questions or comments about this instruction manual, please contact your local LEADER agent.

1. INTRODUCTION

Thank you for purchasing this LEADER instrument. To use this instrument safely, read this instruction manual thoroughly, and make sure that you know how to use the instrument properly.

If some point about the operation of this instrument is still unclear after you have read this instruction manual, refer to the contact information on the back cover of the manual to contact LEADER, or contact your local LEADER agent.

After you have finished reading this manual, keep it in a convenient place so that you can refer to it when necessary.

1.1 Scope of Warranty

This LEADER instrument has been manufactured under the strictest quality control guidelines.

LEADER shall not be obligated to furnish the following free services during the warranty period.

1. Repair of malfunction or damages resulting from fire, natural calamity, or improper voltage applied by the user.
2. Repair of a product that has been improperly repaired, adjusted, or modified by personnel other than a factory-trained LEADER representative.
3. Repair of malfunctions or damages resulting from improper use.
4. Repair of malfunctions caused by devices other than this instrument.
5. Repair of malfunctions or damages without the presentation of a proof of purchase or receipt bill for the instrument.

This Warranty is valid only in Japan.

1.2 Operating Precautions

1.2.1 Maximum Allowable Input Voltage



The maximum signal voltage that can be applied to the input connectors is indicated below. Do not apply excessive voltage to the connectors. Doing so may damage the device or lead to injury.

Table 1-1 Maximum allowable input voltage

Input Connector		Maximum Allowable Voltage
Main unit	EXT REF	± 5 V (DC + peak AC)
Main unit	REMOTE	0 to 5 VDC
SER01	SDI INPUT	± 1 V (DC + peak AC)
SER02 / SER02A	SDI INPUT	± 1 V (DC + peak AC)
SER03	DIGITAL AUDIO INPUT	± 5 V (DC + peak AC)

1. INTRODUCTION

1.2.2 Mechanical Shock

This instrument contains sensitive components, so it may be damaged if it is dropped or otherwise exposed to a strong shock.

1.2.3 Electrostatic Damage

Electronic components can be damaged by static discharge. Static electricity can build up in the core wire of a coaxial cable. Before connecting a coaxial cable to an I/O connector of the instrument, short the core wire of the cable with the external conductor.

1.2.4 Warming Up

To ensure more accurate measurements, turn ON the instrument approximately 30 minutes before you intend to use it to allow its internal temperature to stabilize.

1.2.5 About Standby Mode

Even if you press the power switch to turn off this instrument, the instrument remains in standby mode as long as the power cord is connected to the outlet. In standby mode, some of the internal circuits operate and may generate heat. Unless necessary, keep the power cord disconnected from the outlet.

1.2.6 Backup

This instrument has a last-memory feature. When you turn the power on, the instrument starts with the panel settings that were in use the last time that it was turned off. If the backup battery is out of power, the message "The last memory feature is disabled." will appear, and this last-memory feature will no longer work.

To continually use the last-memory feature, we recommend that you replace the backup battery with a new one every five years after you purchase the instrument. You cannot replace the backup battery yourself. For details, contact your nearest LEADER agent.

1.2.7 About the LCD Panel (LV5600)

There may be a small number of pixels in the LCD panel that do not light or are always on. Note that this is not a malfunction.

The LCD panel supports a large number of video signals. SDI input signals are displayed asynchronously on the LCD. Therefore, images may appear to flicker on the waveform and picture displays.

In addition, the input SDI signal is temporarily stored in frame memory and is loaded by using the LCD display synchronization signal—which is not synchronized with the input SDI signal. Therefore, because frame skip—which skips over frames in the memory—and frame repeat—which reads the same frames of the memory twice—occur, the image may appear to flicker.

(An external sync signal can be used to synchronize the LCD to the input signal.)

1. INTRODUCTION

1.3 About Trademarks and Licenses

The company and product names in this document are trademarks or registered trademarks of their respective holders.

Dolby, Dolby E, Dolby Digital, and Dolby Digital Plus are registered trademarks of Dolby Laboratories.

DynaFont is a registered trademark of DynaComware Taiwan Inc.

This product uses open source software under the GNU General Public License (<http://www.gnu.org/copyleft/gpl.html>).

If you need the source code covered by the GNU General Public License, CONTACT YOUR LOCAL LEADER AGENT.

[Notes]

1. Leader does not provide warranty or support for the software covered by the GNU General Public License.
2. Alteration and distribution of this program shall be performed under your responsibility.
3. The expense of Leader distributing the software to you shall be borne by you.

1.4 Terminology Used in This Manual

- ZEN series

The following products are referred to as ZEN series.

Table 1-2 ZEN series lineup (including options)

Model	Model Name
LV5300	WAVEFORM MONITOR
LV5350	WAVEFORM MONITOR
LV5600	WAVEFORM MONITOR
LV7300	RASTERIZER
LV7600	RASTERIZER

- SER**

LV5600-SER** and LV7600-SER** are referred to as SER**.

- Single Input Mode

This refers to the mode in which on the INPUT menu, **F•7** DISPLAY is set to SINGLE. It is a mode for measuring a single input signal.

- Simul Mode

This refers to the mode in which on the INPUT menu, **F•7** DISPLAY is set to SIMUL. It is a mode for measuring multiple input signals simultaneously.

- Multi-screen Display

This refers to the mode in which the MULTI key is on.

- SFP module

Collective name for SFP+ module (SER05/SER06), and SFP28 module (SER06).

1. INTRODUCTION

- Underlining (_)

Underlined options indicate the default values.

- Input Formats and Link Systems

The following names are used for the input formats and link systems.

Multi link may be used as a collective term to refer to dual link and quad link.

Table 1-3 Input formats and link systems

Name	Description	Link System
SD	SD-SDI	Single link
HD	HD-SDI	Single link
3G-A	3G-SDI level A	Single link
3G-B-DL	3G-SDI level B dual link mapping	Single link
3G-B DS	3G-SDI level B dual stream mapping	Single link
6G	6G-SDI	Single link
12G	12G-SDI	Single link
HD(DL)	HD-SDI dual link	Dual link
3G(DL)-2K	3G-A, 3G-B-DL dual link Resolution 1920 (2048)×1080	Dual link
3G(DL)-4K	3G-B DS dual link Resolution 3840 (4096)×2160	Dual link
HD(QL)	HD-SDI quad link	Quad link
3G(QL)	3G-A, 3G-B-DL quad link	Quad link
3G	Collective name for 3G links	-
3G-B	Collective name for 3G-B-DL and 3G-B DS	-
3G(DL)	Collective name for 3G(DL)-2K, 3G(DL)-4K	-
2K	Collective name for SD, HD, 3G-A, 3G-B-DL, 3G-B DS, HD(DL), 3G(DL)-2K	-
4K	Collective name for 6G, 12G, 3G(QL), 3G(DL)-4K, HD(QL)	-

2. PRODUCT CONFIGURATION

2.1 Lineup

LV5600 WAVEFORM MONITOR	Built-in LCD
LV7600 RASTERIZER	External monitor type

2.2 Hardware Options

This instrument operates as a measuring instrument by installing hardware options. To replace or add hardware options, contact your local LEADER agent. You cannot install or uninstall units.

Table 2-1 Hardware options

Model Name	Lineup		Function
	LV5600	LV7600	
SDI INPUT	LV5600-SER01		SD, HD, 3G SDI input (*1) (6G, 12G SDI input is enabled when SER28 and SER29 are installed)
SDI INPUT/EYE	LV5600-SER02 / LV5600-SER02A		SD, HD, 3G SDI input and eye pattern display (*1, 4) (6G, 12G SDI input is enabled when SER28 and SER29 are installed)
DIGI/ANA AUDIO	LV5600-SER03	LV7600-SER03	Digital/analog audio I/O and display
DOLBY	LV5600-SER04	LV7600-SER04	Dolby E, Dolby Digital, Dolby Digital Plus decode function (*2, 3)
10G IP INPUT	LV5600-SER05	LV7600-SER05	10G IP input (*1)
25G IP INPUT	LV5600-SER06	LV7600-SER06	25G IP input (*1)

- *1 The LV5600 requires the LV5600-SER01, LV5600-SER02, LV5600-SER02A, LV5600-SER05, or LV5600-SER06 to be installed.
The LV7600 requires the LV5600-SER01, LV5600-SER02, LV5600-SER02A, LV7600-SER05, or LV7600-SER06 to be installed.
The LV5600-SER01, and LV5600-SER02 or LV5600-SER02A cannot be installed in the instrument at the same time.
The LV5600-SER05 and LV5600-SER06 cannot be installed in the instrument at the same time.
The LV7600-SER05 and LV7600-SER06 cannot be installed in the instrument at the same time.
- *2 You need the LV5600-SER03 to install the LV5600-SER04 in the LV5600.
You need the LV7600-SER03 to install the LV7600-SER04 in the LV7600.
- *3 Decodes up to 7.1 channels
- *4 The functions of SER02 and SER02A are the same.

2. PRODUCT CONFIGURATION

2.3 Software Options

The following software options (sold separately) can be installed in the instrument. If you want to obtain a software option, provide your local LEADER agent with the instrument's MAC address (see the LICENSE tab) and serial number (see the rear panel). We will issue a license key.

When you receive the license key, install the option by referring to section 7.4, "Installing Software Options." Each instrument requires a unique license key. You cannot use the same key for multiple instruments.

Table 2-2 Software options

Model Name	Lineup		Function
	LV5600	LV7600	
HDR	LV5600-SER23	LV7600-SER23	HDR measurement function
TSG	LV5600-SER24	LV7600-SER24	SDI signal generation function (*1)
FOCUS ASSIST	LV5600-SER25	LV7600-SER25	Focus assist display function
LAYOUT	LV5600-SER26	LV7600-SER26	Customized layout, display assignment function
TALLY	LV5600-SER27	LV7600-SER27	ID, iris, tally display function
4K	LV5600-SER28	LV7600-SER28	4K video signal support function
12G-SDI	LV5600-SER29	LV7600-SER29	12G-SDI and 6G-SDI support (*2)
VIDEO NOISE METER	LV5600-SER30	LV7600-SER30	Video noise measurement function
COLORIMETRY ZONE	LV5600-SER31	LV7600-SER31	Colors outside the color gammut display function
25G IP TSG	LV5600-SER32	LV7600-SER32	25G IP signal generation function (*3)
EXTENDED VEC	LV5600-SER40	LV7600-SER40	Extended vector display function
JPEG XS	LV5600-SER33	LV7600-SER33	JPEG XS measurement function (*4)

*1 You need the LV5600-SER28 to output 4K patterns (other than 12G and 6G) on the LV5600-SER24.

You need the LV7600-SER28 to output 4K patterns (other than 12G and 6G) on the LV7600-SER24.

*2 You need the LV5600-SER28 to install the LV5600-SER29 in the LV5600.

You need the LV7600-SER28 to install the LV7600-SER29 in the LV7600.

*3 You need the LV5600-SER06 to install the LV5600-SER32 in the LV5600.

You need the LV7600-SER06 to install the LV7600-SER32 in the LV7600.

*4 You need the LV5600-SER06 to install the LV5600-SER33 in the LV5600. Also, you need the LV5600-SER32 to output JPEG XS signal and the LV5600-SER28 to input/output 4K patterns.

You need the LV7600-SER06 to install the LV7600-SER33 in the LV7600. Also, you need the LV7600-SER32 to output JPEG XS signal and the LV7600-SER28 to input/output 4K patterns.

2. PRODUCT CONFIGURATION

2.4 Items Sold Separately

LV7290	Ethernet connection remote controller
LV5600	
LR2560	Rack Mount Adapters
LC2565	Blank Panels
LV5600-SER05, LV7600-SER05, LV5600-SER06, LV7600-SER06	
LC2144	SFP+ module for 10GbE multi-mode fibers 300 m
LC2145	SFP+ module for 10GbE single-mode fibers 10 km
LV5600-SER06, LV7600-SER06	
LC2146	SFP28 module for 25GbE multi-mode fibers 70 m
LC2147	SFP28 module for 25GbE single-mode fibers 10 km

- * Modules that you purchase on the market are not supported.
- * For the LV5600-SER06 and LV7600-SER06, attach the included conversion adapter to the IP connector on the rear panel, and then install the SFP+ or SFP28 module.

3. SPECIFICATIONS

3.1 General

The LV5600 WAVEFORM MONITOR and LV7600 RASTERIZER are integrated media measuring and monitoring devices that support various video signals and audio signals. A built-in LCD type and a rasterizer type for use with an external monitor are available, so you can choose the model appropriate for your installation location.

The LV5600 and LV7600 integrate waveform display technologies, measurement technologies, and monitoring technologies that Leader has accumulated over the years to provide both high functionality and superb operability.

In terms of video signals, these instruments support a variety of SDI signals up to 12G-SDI as well as video over IP. The video signal waveform display, vector display, picture display, and eye pattern display enable measurements and quality control of various video signals. The status display allows you to view various error statuses and system stability in the form of event logs and long-term charts.

In terms of audio signals, these instruments support digitally embedded audio signals in SDI or IP signals and digital/analog audio signals received from external sources. Level display, Lissajous display, status display, and so on are available.

In addition to the keys and knobs available on conventional models, these instruments can be controlled through a USB mouse, the touch panel (*1), and on the LV7600, a set of dedicated keys for frequently used camera adjustment menus.

Moreover, a rich lineup of options is available in addition to these powerful functions and operability. Through the combination of these options, these instruments can be used in the measurement, monitoring, and evaluation of video and audio signals in a wide variety of applications including (1) broadcast station master monitoring applications for the integrated monitoring of video and audio signals, (2) monitoring applications for monitoring the quality of transmission signals, (3) studio sub and post production applications for controlling the video signal levels, and (4) broadcast equipment compliance applications for determining whether video and audio signals comply with appropriate standards.

*1 The LV7600 requires a touch-panel type external monitor to be connected to the main unit. The touch panel interface on the external monitor is connected to the LV7600's USB port. The video interface on the external monitor is connected to the LV7600's monitor output connector.

LEADER does not guarantee that all touch panel type monitors will work with the LV7600.

3. SPECIFICATIONS

3.2 Features

- Support for a Variety of Signal Inputs

The abundant video signal input options enable measurement and monitoring of SDI signals and IP (video over IP) signals as well. In terms of audio signals, SDI embedded audio, IP embedded audio, and external AES/EBU and analog audio are supported. The supported audio formats are L-PCM, Dolby E, Dolby Digital, and Dolby Digital Plus.

- Superb Operability

Operability was prioritized in the design of these instruments. You can use the best control interface according to your liking or situation. In addition to the conventional keys and knobs on the front panel, you can control the instrument remotely using a USB mouse. Further, the LV5600 has a 7-inch full-HD touch panel. The LV7600 can be connected to a USB touch panel interface of a touch-panel monitor. These interfaces allow intuitive control and configuration through touch operation.

The LV7600 also has function menu operation keys that can be operated while viewing a remote display and an independent set of dedicated keys for frequently used camera adjustment operations.

These instruments can also be controlled remotely by connecting a dedicated remote controller (sold separately), controlled remotely from a Web browser on a PC over an Ethernet connection, and used to perform automatic measurements using TELNET or FTP.

- Compact

While providing high flexibility through various options and high functionality for various situations, the LV5600 is 3U half-rack size and the LV7600 1U full-rack size, each with 300 mm depth. A 90 V to 240 V AC power supply is employed, so you do not need to worry about where and how to install an AC adapter.

- 4K Video Format (SER28/SER29)

In addition to SD-SDI, HD-SDI, 3G-SDI single link, 6G-SDI single link, 12G-SDI single link, 3G-SDI dual link and quad link, and HD-SDI quad link are supported. These cover SDI signals from SD video format to HD video format and even 4K video format.

For the 4K video format, in the case of 12G-SDI and 6G-SDI single link input, up to four inputs can be displayed through switching. In the case of 3G-SDI dual link input, up to two inputs can be displayed through switching. In the case of 3G-SDI, HD-SDI, or SD-SDI single link input, up to four inputs can be displayed and monitored simultaneously.

- IP Video Format (SER05/SER06/SER33)

The SER05 10G IP INPUT option supports 2K video format signals on IP signal SMPTE ST 2022-6 (uncompressed) and SMPTE ST 2110-20 (uncompressed) are supported. In the case of the 2K video format, up to four channels can be received through a single 10 Gbit Ethernet cable.

The SER06 25G IP INPUT option supports IP signal SMPTE ST 2022-6 (uncompressed) and SMPTE ST 2110-20 (uncompressed) video signals. In the case of SMPTE ST 2110 streams, the 4K (3840x2160) video format can also be decoded. Up to four channels can be decoded for the 2K video format and one channel for the 4K video format.

The SER33 JPEG XS option supports IP signal SMPTE ST 2110-22 (JPEG XS) video signals.

3. SPECIFICATIONS

- Transmission Quality Analysis Function

Signal analysis functions have been enhanced based on the SDI signal measurement technology that Leader has cultivated over the years. Other enhancements have been made to various transmission error monitoring, external sync phase difference display, lip sync measurement (SER03), SDI signal frequency deviation measurement function, equivalent cable length meter function, and the ancillary data analysis function, which has become more important with the introduction of 4K video signals.

For the IP signal measurement, enhanced transmission quality (QoS) monitoring features are available for detecting packet loss, checksum errors, discontinuous packets, and other transmission errors as well as packet jitters and other parameters that have become harder to detect as a result of IP encryption.

- Video Analysis Functions

Numerous types of displays are available for the various video signals such as the video signal waveform display, vector display, picture display, 5-bar display, and CIE chromaticity diagram display. In addition, quality control (QoE) functions for video signals are available including freeze error, black error, and gamut error detection functions. Detected errors can be recorded in event logs.

- Audio Analysis Functions (SER03/SER04)

For audio signals, level meter display is possible on audio signals embedded in SDI or IP signals and AES/EBU audio signals received from external sources.

The SER03 DIGI/ANA AUDIO option allows Lissajous display, surround display, loudness display and detection of mute and clip errors. Detected errors can be recorded in event logs. Moreover, the SER04 DOLBY option allows decoding and displaying Dolby E, Dolby Digital, and Dolby Digital Plus.

- Eye Pattern Display (SER02/SER02A/SER28/SER29) (*1)

Eye pattern display and jitter display, which are physical layer measurements of SDI signals from SD-SDI to 12G-SDI, are possible. These physical layer measurements can be performed using cursors or performed automatically. Measurements can be exported via a network.

A histogram can be superimposed on the eye pattern display.

- Closed Caption Decode Display Function

Japanese closed captions embedded in SDI signals, CEA-608 and CEA-708 closed captions, teletext, and OP47 subtitles can be decoded and displayed.

- External Sync Signal Input with Waveform Display Function

The phase difference and synchronization states of SDI or IP video signals can be shown graphically based on an external reference sync signal (black burst, tri-level sync). Further, the waveform of the applied external reference sync signal can be displayed, allowing early discovery of problems related to the sync signal.

3. SPECIFICATIONS

- Customizable Layout (SER26)

Video signal waveforms, vector waveforms, picture, and other items of input video signals can be laid out freely in the sizes of your choice. It is possible to display up to four input signals simultaneously or display a single input signal in several displays. You can create other display layouts such as displaying a normal picture display of a single input signal next to an HDR CINEZONE display or display the waveforms of all lines simultaneously with a line selection waveform.

- SDI Signal Generation Function (SER24)

The SDI signal reclock output connector also functions as a simple SDI signal generator. It supports HD-SDI to 12G-SDI as well as the 4K video format of 3G-SDI quad link. For the pattern, you can select the HD multiformat color bar, the 4K multiformat color bar, or the color raster pattern, which allows you to select any level. You can also overlay a moving box or insert embedded audio. When SER23 is installed, the HDR color bar can be output.

- 25G IP Signal Generation Function (SER32)

This function generates IP test pattern signals. The IP transmission standard is SMPTE ST 2110-20/22/30/40. This function can generate 2K and 4K (3840x2160) video signal test patterns.

- External Monitor Output

The measurement screen can be output in SDI or TMDS from the monitor output connector. The output signal can be displayed on an external SDI or HDMI monitor (*2) in full high definition resolution.

- CINELITE Feature

The CINELITE feature makes it easy to manage the levels of specific points on the picture display. This is useful for adjusting the gain of multiple cameras to the same reference point. Furthermore, the CINELITE Advanced feature makes it possible to synchronize measurements with the video signal waveform display and vector display. The CINEZONE feature makes it possible to check the luminance distribution of the whole picture display at a glance.

- Capture Feature

A screen capture feature, which captures the entire display as still-image data, is available. Not only can captured data be displayed on the instrument, but it can also be compared with an input signal or saved to a USB memory device as bitmap data for viewing on a PC. A frame capture feature is also available. If an SDI Signal is being received, a frame including the blanking interval can be captured. If an IP signal is being received, a frame covering the active video period can be captured. You can set the frame capture function mode to manual or auto, which captures frames when errors occur. The frame capture data can be viewed and searched through on a PC using a frame capture viewer.

- Time Code Display

The timecodes embedded in SDI or IP signals can be displayed. The timecode can also be used as the timestamp in the event log.

- External Remote Connector

A contact terminal can be used to load presets, switch the input signal, and transmit alarms.

3. SPECIFICATIONS

- Ethernet Port

The following features become available when you connect the instrument to a PC: remote control through TELNET, file transfer through FTP, remote control and alarm generation through SNMP, remote control from a Web browser through HTTP, and internal clock synchronization through SNTP. Using the LV7290 REMOTE CONTROLLER (sold separately) allows up to eight LV5600s, or LV7600s to be remote controlled.

- HDR (SER23)

Level monitoring is possible on HLG and PQ defined in ITU-R BT.2100 as well as S-Log3, C-LOG, and Log-C compatible HDR signals. Level control is possible based on the estimated brightness (Nits) of a display taking the OOTF into consideration. Video signal waveform display supports IRE scale as well as HDR scale. On CINEZONE display, the SDR area is displayed in monochrome, while the HDR area is displayed using colors corresponding to the brightness. This makes it easy to view the brightness distribution in the HDR area. Furthermore, you can display the MAX FALL and MAX CLL compliant with CEA-861.

- Focus Assist (SER25)

A new focusing algorithm based on nonlinear super-resolution technology has been developed, allowing highly sensitive focusing even on low-contrast images that were difficult to be focused in on in the past. You can select the sensitivity according to the image scene.

- RS-422/485 Connector (SER27)

For serial communication, you can select the Leader's standard protocol or TSL protocol. When using the Leader's standard protocol, you can remotely recall presets, switch the display channel, and display the camera ID, iris, and tally by using serial communication. When using the TSL protocol, you can control the camera ID (LABEL-1) and tally (TALLY-1, TALLY-2) displays.

- Video Noise Measurement Function (SER30)

Noise included in the Y, G, B, or R signal of the SDI signal applied to the LV5600 and LV7600 can be measured.

- Colorimetry Zone Display (SER31)

For the ITU-R BT.2020 input signal, colors outside the ITU-R BT.709 or DCI color gamut can be displayed as a mesh pattern on the picture.

*1 Only SDI INPUT 1 supports the eye pattern display.

*2 LEADER does not guarantee the operation on all HDMI monitors.

3. SPECIFICATIONS

3.3 Specifications

3.3.1 SDI Video Formats and Standards (SER01/SER02/SER02A/SER28/SER29)

Table 3-1 SD video signal formats and standards

Color System	Quantization	Image	Field Frequency/Scanning	Supported Standard
YCbCr 4:2:2	10 bit	720×487	59.94 /I	SMPTE ST 259
		720×576	50 /I	

Table 3-2 HD video signal formats and standards

Color System	Quantization	Image	Frame (Field) Frequency/Scanning	Supported Standard
YCbCr 4:2:2	10 bit	1280×720	60/59.94/50/30/29.97/25/24/23.98 /P	SMPTE ST 292-1 SMPTE ST 296
		1920×1080	60/59.94/50 /I	SMPTE ST 274
			30/29.97/25/24/23.98 /P	SMPTE ST 292-1
			30/29.97/25/24/23.98 /PsF	

3. SPECIFICATIONS

Table 3-3 3G-A video signal formats and standards

Color System	Quantization	Image	Frame (Field) Frequency/Scanning	Supported Standard
YCbCr 4:2:2	10 bit	1920×1080	60/59.94/50 /P	SMPTE ST 274 SMPTE ST 425-1
			48/47.95 /P	-
		2048×1080	60/59.94/50/48/47.95 /P	SMPTE ST 425-1 SMPTE ST 2048-2
		12 bit	1920×1080	60/59.94/50 /I
	30/29.97/25/24/23.98 /P			SMPTE ST 425-1
	30/29.97/25/24/23.98 /PsF			
	2048×1080		30/29.97/25/24/23.98 /P	SMPTE ST 425-1 SMPTE ST 2048-2
	YCbCr 4:4:4	10 bit	1280×720	60/59.94/50/30/29.97/25/24/23.98 /P
1920×1080			60/59.94/50 /I	SMPTE ST 274
			30/29.97/25/24/23.98 /P	SMPTE ST 425-1
			30/29.97/25/24/23.98 /PsF	
2048×1080			30/29.97/25/24/23.98 /P	SMPTE ST 425-1
30/29.97/25/24/23.98 /PsF			SMPTE ST 2048-2	
12 bit		1920×1080	60/59.94/50 /I	SMPTE ST 274
			30/29.97/25/24/23.98 /P	SMPTE ST 425-1
		2048×1080	30/29.97/25/24/23.98 /P	SMPTE ST 425-1
		30/29.97/25/24/23.98 /PsF	SMPTE ST 2048-2	
RGB 4:4:4	10 bit	1280×720	60/59.94/50/30/29.97/25/24/23.98 /P	SMPTE ST 296 SMPTE ST 425-1
		1920×1080	60/59.94/50 /I	SMPTE ST 274
			30/29.97/25/24/23.98 /P	SMPTE ST 425-1
			30/29.97/25/24/23.98 /PsF	
		2048×1080	30/29.97/25/24/23.98 /P	SMPTE ST 425-1
		30/29.97/25/24/23.98 /PsF	SMPTE ST 2048-2	
	12 bit	1920×1080	60/59.94/50 /I	SMPTE ST 274
			30/29.97/25/24/23.98 /P	SMPTE ST 425-1
		2048×1080	30/29.97/25/24/23.98 /P	SMPTE ST 425-1
			30/29.97/25/24/23.98 /PsF	SMPTE ST 2048-2
			30/25/24 /PsF	
XYZ 4:4:4	12bit	2048×1080	30/25/24 /P	SMPTE ST 425-1
			30/25/24 /PsF	SMPTE ST 428

3. SPECIFICATIONS

Table 3-4 3G-B-DL, HD(DL) Video Signal Formats and Standards

Color System	Quantization	Image	Frame (Field) Frequency/Scanning	Supported Standard
YCbCr 4:2:2	10 bit	1920×1080	60/59.94/50 /P	SMPTE ST 274 SMPTE ST 372 SMPTE ST 425-1
			48/47.95 /P	-
		2048×1080	60/59.94/50/48/47.95 /P	SMPTE ST 372 SMPTE ST 425-1 SMPTE ST 2048-2
	12 bit	1920×1080	60/59.94/50 /I	SMPTE ST 274
			30/29.97/25/24/23.98 /P	SMPTE ST 372
			30/29.97/25/24/23.98 /PsF	SMPTE ST 425-1
		2048×1080	30/29.97/25/24/23.98 /P	SMPTE ST 372
			30/29.97/25/24/23.98 /PsF	SMPTE ST 425-1 SMPTE ST 2048-2
YCbCr 4:4:4	10 bit	1920×1080	60/59.94/50 /I	SMPTE ST 274
			30/29.97/25/24/23.98 /P	SMPTE ST 372
			30/29.97/25/24/23.98 /PsF	SMPTE ST 425-1
		2048×1080	30/29.97/25/24/23.98 /P	SMPTE ST 372
	30/29.97/25/24/23.98 /PsF		SMPTE ST 425-1 SMPTE ST 2048-2	
	12 bit	1920×1080	60/59.94/50 /I	SMPTE ST 274
			30/29.97/25/24/23.98 /P	SMPTE ST 372
			30/29.97/25/24/23.98 /PsF	SMPTE ST 425-1
2048×1080		30/29.97/25/24/23.98 /P	SMPTE ST 372	
	30/29.97/25/24/23.98 /PsF	SMPTE ST 425-1 SMPTE ST 2048-2		
RGB 4:4:4	10 bit	1920×1080	60/59.94/50 /I	SMPTE ST 274
			30/29.97/25/24/23.98 /P	SMPTE ST 372
			30/29.97/25/24/23.98 /PsF	SMPTE ST 425-1
		2048×1080	30/29.97/25/24/23.98 /P	SMPTE ST 372
	30/29.97/25/24/23.98 /PsF		SMPTE ST 425-1 SMPTE ST 2048-2	
	12 bit	1920×1080	60/59.94/50 /I	SMPTE ST 274
			30/29.97/25/24/23.98 /P	SMPTE ST 372
			30/29.97/25/24/23.98 /PsF	SMPTE ST 425-1
2048×1080		30/29.97/25/24/23.98 /P	SMPTE ST 372	
	30/29.97/25/24/23.98 /PsF	SMPTE ST 425-1 SMPTE ST 2048-2		
XYZ 4:4:4	12bit	2048×1080	30/25/24 /P	SMPTE ST 372
			30/25/24 /PsF	SMPTE ST 425-1 SMPTE ST 428

* When these signals are displayed, phase differences of up to 100 clocks (approx. 1.34 μs) between HD(DL) links are automatically corrected.

3. SPECIFICATIONS

Table 3-5 3G-B DS video signal formats and standards

Color System	Quantization	Image	Frame (Field) Frequency/Scanning	Supported Standard
Y _C B _R C _R 4:2:2	10 bit	1920×1080	60/59.94/50 /I	SMPTE ST 274
			30/29.97/25/24/23.98 /P	SMPTE ST 425-1
			30/29.97/25/24/23.98 /PsF	
		1280×720	60/59.94/50/30/29.97/25/24/23.98 /P	SMPTE ST 296 SMPTE ST 425-1

Table 3-6 3G(DL)-2K Video Signal Formats and Standards

Color System	Quantization	Image	Frame (Field) Frequency/Scanning	Supported Standard
Y _C B _R C _R 4:2:2	12 bit	1920×1080	60/59.94/50 /P	SMPTE ST 274 SMPTE ST 425-3
			48/47.95 /P	-
		2048×1080	60/59.94/50/48/47.95 /P	SMPTE ST 2048-2 SMPTE ST 425-3
Y _C B _R C _R 4:4:4	10 bit	1920×1080	60/59.94/50 /P	SMPTE ST 274 SMPTE ST 425-3
		2048×1080	60/59.94/50/48/47.95 /P	SMPTE ST 2048-2 SMPTE ST 425-3
	12 bit	1920×1080	60/59.94/50 /P	SMPTE ST 274 SMPTE ST 425-3
		2048×1080	60/59.94/50/48/47.95 /P	SMPTE ST 2048-2 SMPTE ST 425-3
RGB 4:4:4	10 bit	1920×1080	60/59.94/50 /P	SMPTE ST 274 SMPTE ST 425-3
		2048×1080	60/59.94/50/48/47.95 /P	SMPTE ST 2048-2 SMPTE ST 425-3
	12 bit	1920×1080	60/59.94/50 /P	SMPTE ST 274 SMPTE ST 425-3
		2048×1080	60/59.94/50/48/47.95 /P	SMPTE ST 2048-2 SMPTE ST 425-3

* When these signals are displayed, phase differences of up to 100 clocks (approx. 0.67 μs) between links are automatically corrected.

* 3G-A and 3G-B-DL links are supported.

3. SPECIFICATIONS

Table 3-7 3G(DL)-4K Video Signal Formats and Standards

Division Transmission System	Color System	Quantization	Image	Frame Frequency/Scanning	Supported Standard
Square	YCbCr 4:2:2	10 bit	3840×2160	30/29.97/25/24/23.98 /P	SMPTE ST 425-3 SMPTE ST 2036-1
				30/29.97/25/24/23.98 /PsF	-
			4096×2160	30/29.97/25/24/23.98 /P	SMPTE ST 425-3 SMPTE ST 2048-1
				30/29.97/25/24/23.98 /PsF	-
2 sample interleave	YCbCr 4:2:2	10 bit	3840×2160	30/29.97/25/24/23.98 /P	SMPTE ST 425-3 SMPTE ST 2036-1
			4096×2160	30/29.97/25/24/23.98 /P	SMPTE ST 425-3 SMPTE ST 2048-1

* You also need the SER28.

* When these signals are displayed, phase differences of up to 100 clocks (approx. 0.67 μs) between links are automatically corrected.

* 3G-B DS links are supported.

Table 3-8 HD(QL) video signal formats and standards

Division Transmission System	Color System	Quantization	Image	Frame Frequency/Scanning	Supported Standard
Square	YCbCr 4:2:2	10 bit	3840×2160	30/29.97/25/24/23.98 /P	-
				30/29.97/25/24/23.98 /PsF	-
			4096×2160	30/29.97/25/24/23.98 /P	-
				30/29.97/25/24/23.98 /PsF	-

* You also need the SER28.

* When these signals are displayed, phase differences of up to 100 clocks (approx. 0.67 μs) between links are automatically corrected.

3. SPECIFICATIONS

Table 3-9 3G(QL) video signal formats and standards

Division Transmission System	Color System	Quantization	Image	Frame Frequency/Scanning	Supported Standard	
Square	Y _C B _C R 4:2:2	10 bit	3840×2160	60/59.94/50 /P	SMPTE ST 425-5 SMPTE ST 2036-1	
				48/47.95 /P	-	
		12 bit	3840×2160	60/59.94/50/48/47.95 /P	SMPTE ST 425-5 SMPTE ST 2048-1	
				30/29.97/25/24/23.98 /P	SMPTE ST 425-5 SMPTE ST 2036-1	
			4096×2160	30/29.97/25/24/23.98 /PsF	-	
				30/29.97/25/24/23.98 /P	SMPTE ST 425-5 SMPTE ST 2048-1	
	Y _C B _C R 4:4:4	10 bit	3840×2160	30/29.97/25/24/23.98 /P	SMPTE ST 425-5 SMPTE ST 2036-1	
				30/29.97/25/24/23.98 /PsF	-	
		12 bit	3840×2160	30/29.97/25/24/23.98 /P	SMPTE ST 425-5 SMPTE ST 2048-1	
				30/29.97/25/24/23.98 /PsF	-	
			4096×2160	30/29.97/25/24/23.98 /P	SMPTE ST 425-5 SMPTE ST 2048-1	
				30/29.97/25/24/23.98 /PsF	-	
	RGB 4:4:4	10 bit	3840×2160	30/29.97/25/24/23.98 /P	SMPTE ST 425-5 SMPTE ST 2036-1	
				30/29.97/25/24/23.98 /PsF	-	
		12 bit	3840×2160	30/29.97/25/24/23.98 /P	SMPTE ST 425-5 SMPTE ST 2048-1	
				30/29.97/25/24/23.98 /PsF	-	
			4096×2160	30/29.97/25/24/23.98 /P	SMPTE ST 425-5 SMPTE ST 2048-1	
				30/29.97/25/24/23.98 /PsF	-	
	XYZ 4:4:4	12bit	4096×2160	30/25/24 /P	SMPTE ST 425-5 SMPTE ST 428	
				30/25/24 /PsF	-	
		10 bit	3840×2160	60/59.94/50 /P	SMPTE ST 425-5 SMPTE ST 2036-1	
				48/47.95 /P	-	
	2 sample interleave	Y _C B _C R 4:2:2	10 bit	4096×2160	60/59.94/50/48/47.95 /P	SMPTE ST 425-5

3. SPECIFICATIONS

Division Transmission System	Color System	Quantization	Image	Frame Frequency/Scanning	Supported Standard	
		12 bit	3840×2160	30/29.97/25/24/23.98 /P	SMPTE ST 2048-1	
					SMPTE ST 425-5 SMPTE ST 2036-1	
		4096×2160	30/29.97/25/24/23.98 /P	SMPTE ST 425-5 SMPTE ST 2048-1		
				SMPTE ST 425-5 SMPTE ST 2036-1		
		YCbCr 4:4:4	10 bit	3840×2160	30/29.97/25/24/23.98 /P	SMPTE ST 425-5 SMPTE ST 2036-1
				4096×2160	30/29.97/25/24/23.98 /P	SMPTE ST 425-5 SMPTE ST 2048-1
	12 bit	3840×2160	30/29.97/25/24/23.98 /P	SMPTE ST 425-5 SMPTE ST 2036-1		
				SMPTE ST 425-5 SMPTE ST 2048-1		
		4096×2160	30/29.97/25/24/23.98 /P	SMPTE ST 425-5 SMPTE ST 2048-1		
				SMPTE ST 425-5 SMPTE ST 2048-1		
	RGB 4:4:4	10 bit	3840×2160	30/29.97/25/24/23.98 /P	SMPTE ST 425-5 SMPTE ST 2036-1	
			4096×2160	30/29.97/25/24/23.98 /P	SMPTE ST 425-5 SMPTE ST 2048-1	
		12 bit	3840×2160	30/29.97/25/24/23.98 /P	SMPTE ST 425-5 SMPTE ST 2036-1	
			4096×2160	30/29.97/25/24/23.98 /P	SMPTE ST 425-5 SMPTE ST 2048-1	
XYZ 4:4:4	12bit	4096×2160	30/25/24 /P	SMPTE ST 425-5 SMPTE ST 428		

* You also need the SER28.

* When these signals are displayed, phase differences of up to 100 clocks (approx. 0.67 μs) between links are automatically corrected.

* 3G-A and 3G-B-DL links are supported.

Table 3-10 6G video signal formats and standards

Division Transmission System	Color System	Quantization	Image	Frame Frequency/Scanning	Supported Standard
2 sample interleave	YCbCr 4:2:2	10bit	3840×2160	30/29.97/25/24/23.98 /P	SMPTE ST 2036-1 SMPTE ST 2081-10
			4096×2160	30/29.97/25/24/23.98 /P	SMPTE ST 2048-1 SMPTE ST 2081-10

* You also need the SER28 and SER29.

* If you input 6G-SDI signal without the Sync Bit Insertion, the instrument displays "NO SIGNAL" and cannot receive the signal.

3. SPECIFICATIONS

Table 3-11 12G video signal formats and standards

Division Transmission System	Color System	Quantization	Image	Frame Frequency/Scanning	Supported Standard	
2 sample interleave	YCbCr 4:2:2	10 bit	3840×2160	60/59.94/50 /P	SMPTE ST 2036-1 SMPTE ST 2082-10	
				48/47.95/P	-	
		12 bit	3840×2160	30/29.97/25/24/23.98 /P	SMPTE ST 2036-1 SMPTE ST 2082-10	
				4096×2160	30/29.97/25/24/23.98 /P	SMPTE ST 2048-1 SMPTE ST 2082-10
		YCbCr 4:4:4	10 bit	3840×2160	30/29.97/25/24/23.98 /P	SMPTE ST 2036-1 SMPTE ST 2082-10
					4096×2160	30/29.97/25/24/23.98 /P
	12 bit		3840×2160	30/29.97/25/24/23.98 /P	SMPTE ST 2036-1 SMPTE ST 2082-10	
				4096×2160	30/29.97/25/24/23.98 /P	SMPTE ST 2048-1 SMPTE ST 2082-10
	RGB 4:4:4		10 bit	3840×2160	30/29.97/25/24/23.98 /P	SMPTE ST 2036-1 SMPTE ST 2082-10
					4096×2160	30/29.97/25/24/23.98 /P
		12 bit	3840×2160	30/29.97/25/24/23.98 /P	SMPTE ST 2036-1 SMPTE ST 2082-10	
				4096×2160	30/29.97/25/24/23.98 /P	SMPTE ST 2048-1 SMPTE ST 2082-10

* You also need the SER28 and SER29.

* If you input 12G-SDI signal without the Sync Bit Insertion, the instrument displays "NO SIGNAL" and cannot receive the signal.

3. SPECIFICATIONS

3.3.2 IP Video Formats and Standards (SER05/SER06)

Supported IP Formats

SER05 SMPTE ST 2022-6, SMPTE ST 2110-20
 SER06 SMPTE ST 2022-6, SMPTE ST 2110-20

Redundant System Supported Standard

SMPTE ST 2022-7

Synchronization Mode

PTP (SMPTE ST 2059-1/2)

Supported Protocol

SER05 IPv4 (Internet Protocol version 4)
 IGMPv2/v3 (Internet Group Management Protocol)
 NMOS (IS-04 v1.2/v1.3 / IS-05 v1.0) (*1)

SER06 IPv4 (Internet Protocol version 4)
 IGMPv2/v3 (Internet Group Management Protocol)
 NMOS (IS-04 v1.2/v1.3 / IS-05 v1.0) (*1)

Table 3-12 10G IP input signal formats (SER05, SER06)

Link	Compression	Color System	Quantization	Image	Frame (Field) Frequency/Scanning
SD (*2)	Uncompressed	Y _C B _C R _R 4:2:2	10bit	720x487	59.94 /I
				720x576	50 /I
HD	Uncompressed	Y _C B _C R _R 4:2:2	10bit	1920x1080	60/59.94/50 /I 30/29.97/25/24/23.98 /P 30/29.97/25/24/23.98 /PsF
				1280x720	60/59.94/50 /P 30/29.97/25/24/23.98 /P
3G-A	Uncompressed	Y _C B _C R _R 4:2:2	10bit	1920x1080	60/59.94/50 /P

Table 3-13 25G IP input signal formats (SMPTE ST 2022-6) (SER06)

Link	Compression	Color System	Quantization	Image	Frame (Field) Frequency/Scanning
SD (*2)	Uncompressed	Y _C B _C R _R 4:2:2	10bit	720x487	59.94 /I
				720x576	50 /I
HD	Uncompressed	Y _C B _C R _R 4:2:2	10bit	1920x1080	60/59.94/50 /I 30/29.97/25/24/23.98 /P 30/29.97/25/24/23.98 /PsF
				1280x720	60/59.94/50 /P 30/29.97/25/24/23.98 /P
3G-A	Uncompressed	Y _C B _C R _R 4:2:2	10bit	1920x1080	60/59.94/50 /P

3. SPECIFICATIONS

Table 3-14 25G IP input signal formats (SMPTE ST 2110-20) (SER06)

Link	Compression	Color System	Quantization	Image	Frame (Field) Frequency/Scanning
HD	Uncompressed	Y _C B _C R _R 4:2:2	10bit	1920x1080	60/59.94/50 /I 30/29.97/25/24/23.98 /P 30/29.97/25/24/23.98 /PsF
				1280x720	60/59.94/50/ 30/29.97/25/24/23.98 /P
3G-A	Uncompressed	Y _C B _C R _R 4:2:2	10bit	1920x1080	60/59.94/50 /P
4K (*3)	Uncompressed	Y _C B _C R _R 4:2:2	10bit	3840x2160	60/59.94/50 /P 30/29.97/25/24/23.98 /P

*1 For NMOS control, the instrument's Ethernet port is used.

*2 Only SMPTE ST 2022-6 is supported.

*3 SER28 must be installed to input 4K signals

3.3.3 JPEG XS Video Formats and Standards (SER33)

Supported IP Standards

Transmission Standard	SMPTE ST 2110-22
Compression Standard	ISO/IEC 21122、RFC9134
profile	High Profile 422.12
Packetize	Codestream
Number of Streams	1

Table 3-15 JPEG XS input signal formats

Link	Compression	Compression Ratio	Color System	Quantization	Image	Frame (Field) Frequency/Scanning
HD	JPEG XS	40:1 to 2:1 (0.5 to 10.0 bpp)	Y _C B _C R _R 4:2:2	10bit	1280x720	60/59.94/50/ 30/29.97/25/24/23.98 /P
		40:1 to 2.5:1 (0.5 to 8.0 bpp)	Y _C B _C R _R 4:2:2		1920x1080	60/59.94/50 /I 30/29.97/25/24/23.98 /P 30/29.97/25/24/23.98 /PsF
3G-A	JPEG XS	40:1 to 2.5:1 (0.5 to 8.0 bpp)	Y _C B _C R _R 4:2:2	10bit	1920x1080	60/59.94/50 /P
4K (*1)	JPEG XS	40:1 to 5:1 (0.5 to 4.0 bpp)	Y _C B _C R _R 4:2:2	10bit	3840x2160	60/59.94/50/ 30/29.97/25/24/23.98 /P

*1 SER28 must be installed to input 4K signals

3. SPECIFICATIONS

3.3.4 SDI Audio Formats and Standards (SER01/SER02/SER02A/SER03/SER04)

Supported Standard

12G, 6G, 3G, HD, HD(DL) SMPTE ST 299
SD SMPTE ST 272

Sampling Frequency 48 kHz

Quantization 24 bit

Format L-PCM, Dolby-E, Dolby Digital, Dolby Digital Plus

Clock Generation Generated from the video clock

Synchronization Synchronized to the video signal

All SDI signals must be synchronized during Simul Display.

SDI Audio Channel Separation

Single Input Mode Separates up to two groups (8 channels) from any SDI input.

Simul Mode (2K SD/HD/3G-A/3G-B-DL)

Separates up to four groups (16 channels) from any SDI input.

SDI Audio Channel Separation (SER03)

Separates up to four groups (16 channels) from any SDI input.

3.3.5 IP Audio Formats and Standards (SER03/SER04/SER05/SER06)

Supported Standard SMPTE ST 2022-6, SMPTE ST 2110-30

Sampling Frequency 48 kHz

Quantization 24 bit

Format L-PCM

Packet time 1 msec, 125 usec

Clock Generation System Generated from the video clock

Synchronization Relationship Synchronized to the video signal

All video and audio streams must be synchronized during Simul Display.

IP Audio Channel Separation

Single Input Mode Separates up to two groups (8 channels) from any IP input.

Simul Mode (2K SD/HD/3G-A/3G-B-DL/IP)

Separates up to four groups (8 channels) from any IP input.

IP Audio Channel Separation (SER03)

Separates up to four groups (16 channels) from any IP input.

Supported Channel Order

Mono, Dual Mono, Standard Stereo, Matrix Stereo,
5.1 Surround, 7.1 Surround, One SDI audio group, Undefined

3. SPECIFICATIONS

3.3.6 External Digital I/O Audio Formats and Standards (SER03/SER04)

Supported Standard	AES-3id
Sampling Frequency	48 kHz
Quantization	24 bit
Format	L-PCM, Dolby-E, Dolby Digital, Dolby Digital Plus
Output Signal	Separates and outputs audio signals embedded in SDI or IP signals (audio channel displayed on the screen) Dolby signals are decoded and output.

3.3.7 SDI Input Connector (SER01/SER02/SER02A/SER28/SER29)

Connector Type	BNC
Number of Input Connectors	4 (SDI INPUT 1, 2, 3, 4)
Input Impedance	75Ω
Input Return Loss	
5 MHz to 1.485 GHz	-15 dB or more
1.485 to 2.970 GHz	-10 dB or more
2.970 to 5.940 GHz	-7 dB or more
5.940 to 11.880 GHz	-4 dB or more
Maximum Input Voltage	±1 V (DC + peak AC)
Eye Pattern Display	Eye pattern display is possible only on SDI INPUT 1.

3.3.8 SDI Output Connector (SER01/SER02/SER02A/SER24/SER28/SER29)

Connector Type	BNC
Number of Output Connectors	4 (SDI OUTPUT 1, 2, 3, 4)
Output Impedance	75Ω
Output Return Loss	
5 MHz to 1.485 GHz	-15 dB or more
1.485 to 2.970 GHz	-10 dB or more
2.970 to 5.940 GHz	-7 dB or more
5.940 to 11.880 GHz	-4 dB or more
Output Voltage	800 mVp-p ± 10 % (into 75 Ω)
Output Signal	Relocked signal of SDI input (*1), TSG output
Relocked Signal	Relocks the SDI signals of SDI INPUT 1 to 4 and outputs them through SDI OUTPUT 1 to 4
Select Relocked Signal	SDI OUTPUT 1 can relock and output a signal from SDI INPUT 1 to 4 by switching. (*2)
IP / SDI Conversion Signal	If SER26 is installed, the instrument can output the SDI signal converted from the IP signal assigned by Display Assignment. (*3)
Payload ID Insertion	ST2110-40 / NMOS (SDP) / Manual (*4)
Signal Generation Function	SDI OUTPUT 1 to 4 output SDI signals as a TSG

*1 When SDI system setting is 2K SD/HD/3G-B-DL/3G-A and input signal is 6G-SDI, relock output is not possible.

*2 Valid when the display assignment mode is set to off.

*3 When 4K is measured, 12G-SDI output is not available.

3. SPECIFICATIONS

- *4 The 4K SMPTE ST 2110-20 input signal (60/59.94/50/P) is converted to 3G Quad Link, so the 3G Quad Link payload ID is inserted. The 4K Single Stream SMPTE ST 2110-20 input signal (30/29.97/25/24/23.98/P) is converted to 3G Dual link, so the 3G Dual link payload ID is inserted.

3.3.9 IP Input/Output Connectors (SER05/SER06)

SER05

Connector Type	SFP+
Number of Ports	2
Supported Standard	10GBASE-SR, 10GBASE-LR
Fiber Types	Multi-mode, single-mode

SER06

Connector Type	QSFP+, QSFP28
Supported SFP	SFP+, SFP28 (*1)
Number of Ports	2 (*2)
Supported Standard	10GBASE-SR, 10GBASE-LR, 25GBASE-SR, 25GBASE-LR
Fiber Types	Multi-mode, single-mode

*1 The conversion adapter included with the SER06 is used when installing the SFP+ or SFP28.

*2 The standard must be matched between the two I/O connectors.

3.3.10 External Reference Input

Connector Type	BNC
Number of Input Connectors	1 pair
Input Impedance	15 k Ω passive loop-through
Input Return Loss	\geq 30 dB for 50 kHz to 30 MHz into 75 Ω
Maximum Input Voltage	\pm 5 V (DC + peak AC)
Input Signal	Tri-level sync or NTSC/PAL black burst signal (NTSC 10 field IDs are supported.)
Function	Video signal waveform display and phase difference display based on the phase of an external sync signal Waveform display of external sync signal

* The display position of the video signal waveform display and the measured phase of the phase difference display based on the phase of the external sync signal may vary by \pm 1 clock depending on the timing when the external sync signal or SDI signal is connected or disconnected or when the device is restarted.

* Video signal waveform display based on the phase of an external sync signal is not possible for the following formats.

- IP input video signal using SER05/SER06
- 3G's 720/30P, 720/29.97P, 720/25P, 720/24P, 720/23.98P
- HD(DL)'s 1080/60P, 1080/59.94P, 1080/50P
- 3G(DL), 3G(QL), HD(QL), 6G, 12G
- Frame frequency 48P, 47.95P

* Phase difference display based on the phase of an external sync signal is not possible for the following formats.

- 3G's 720/30P, 720/29.97P, 720/25P, 720/24P, 720/23.98P
- Frame frequency 48P, 47.95P

* Waveform display using an external sync signal is not possible for the following formats.

- HD Dual Link, 3G Dual Link, 3G-B DS

3. SPECIFICATIONS

3.3.11 External Audio Input/Output Connectors (SER03/SER04)

Digital Audio I/O Connectors

Connector Type	DIN 1.0/2.3 connector
Number of I/O Connectors	
Group A	4 pairs (8 channels)
Group B	4 pairs (8 channels)
I/O Impedance	75Ω
Maximum Input Voltage	±5 V (DC + peak AC)
Output Voltage	1.0 Vp-p ± 10 % (into 75 Ω)
Input/Output Switching	By group (4 pairs (8 channels))
Output Signal	Audio signal displayed on the screen

Analog Audio I/O Connectors

Connector Type	37-pin D-sub (female)
I/O Signal Format	Balanced DC coupling
I/O Channels	8 channels
Input/Output Switching	Switch all channels
Input Impedance	≤ 20 kΩ
Maximum Input Voltage	24 dBu
Output Impedance	Nominal 50 Ω
Output Signal	8 audio signal channels displayed on the screen Dolby E, Dolby Digital, and Dolby Digital Plus are decoded and output in analog format.
Maximum Output Level	24 dBu ± 0.5 dB 1 kHz (into a balanced load of 100 kΩ or more)

3.3.12 Monitor Output Connector

SDI Output Connector

Function	Output the displayed screen to an SDI monitor
Output Connector	BNC
Number of Output Connectors	1
Output Impedance	75Ω
Output Return Loss	
5 MHz to 1.485 GHz	15 dB or more
1.485 to 2.97 GHz	10 dB or more
Output Voltage	800 mVp-p ± 10 % (into 75 Ω)
Output Signal	Outputs the LCD screen in HD, 3G-A, or 3G-B-DL.
Output Format	

Color System	Quantization	Image	Frame (Field) Frequency/Scanning	Supported Standard
YCbCr 4:2:2	10 bit	1920×1080	60/59.94/50 /I 24/23.98 /PsF (*1) 60/59.94/5048/47.95 /P	SMPTE ST 274

Synchronization

Synchronized with the LCD refresh rate
(free run or frequency synchronization with the external reference signal)

3. SPECIFICATIONS

T.M.D.S Output Connector

Function	Output the displayed screen to an HDMI monitor (*2)
Output Connector	HDMI
Number of Output Connectors	1
Signal Format	Single Link T.M.D.S
DDC	Not supported
HOT PLUG Detection	Not supported
Output Signal	Outputs the LCD screen
Image	1920×1080
Frame Frequency	60P, 59.94P, 50P, 48P, 47.95P
Synchronization	Synchronized with the LCD refresh rate (free run or frequency synchronization with the external reference signal)
Touch Control	Touch control possible by connecting the USB touch panel interface of a touch panel monitor to the LV5600 or LV7600 (*3)

*1 Equivalent to 48I when the SDI input is 48P.

*2 LEADER does not guarantee the operation on all HDMI monitors.

*3 LEADER does not guarantee that all touch panel type monitors will work with the LV5600 or LV7600.

3.3.13 Headphone Output

Output Connector	
LV5600	One 3.5 mm mini jack (stereo)
LV7600	One stereo jack
Output Signal	2 channels from the audio signals that are being displayed on the screen (downmixed Lt and Rt are also possible)
Sampling Frequency	48 kHz
Volume Adjustment	Using the menu
Power Output	100 mW maximum (into 8 Ω load)

3.3.14 Control Connectors

USB Port	
Port Type	Standard A
Number of Ports	2
Specifications	USB 2.0
Compatible Devices	USB memory, USB mouse, touch panel monitor
USB Memory Feature	Saves capture data, preset data, event log data, data dumps, and loudness log data (SER03)
USB Memory Supported Format	FAT32 (*1)
USB Mouse Feature	Used to control on the screen
Touch panel monitor	Touch control of the displayed screen (*2, *3)

3. SPECIFICATIONS

Ethernet Port

Supported Standard	IEEE802.3
Supported Protocol	
TELNET (*4)	Command control, status query
FTP	File transfer
SNMP	Command control, alarm query
HTTP	Remote monitoring and control from a Web browser
SNTP	Internal clock synchronization
NMOS (IS-04/05) (SER05/SER06)	This instrument's registration control
Connector Type	RJ-45
Type	10Base-T, 100Base-TX, 1000Base-T
Function	Remote control from an external PC or remote controller (*4), file transfer, status information query

Remote Connector

Port Type	15-pin D-sub (female)
Locking Screws	Inch screws (No.4-40UNC)
Number of Ports	1
Control Signal	LV-TTL level (low active)
Input Voltage Range	0 to 5 V DC All inputs are pulled up to +3.3 V (control is also possible using +5 V)
Function	Load preset settings, switch input signals, transmit alarm signals activate tally, and start, stop, and clear the loudness measurement
Alarm Output	Outputs alarms signals when a format alarm occurs, when various errors occur, when the fan malfunctions, or when the internal temperature is abnormal

RS-422/485 Connector (SER27)

Supported Protocols	
Leader	Receives tally, camera ID, and camera iris signals and displays them
TSL UMD Protocol	Tally (TALLY-1, TALLY-2), camera ID (LABEL-1) reception display
Supported Versions	UMD 3.1, UMD 4.0
Port Type	RJ-45
Number of Ports	2

*1 LEADER does not guarantee that all USB-HDD and USB memory devices will work with the LV5600 or LV7600. Depending on the USB device to be connected, LV5600 or LV7600 may not operate normally.

*2 Pinch out and swipe operations are not supported.

*3 LEADER does not guarantee that all touch panel type monitors will work with the LV5600 or LV7600.

*4 You cannot use TELNET and the LV7290 at the same time.

3. SPECIFICATIONS

3.3.15 Front Panel

Display (LV5600)

LCD Type	7-inch color TFT
Resolution	1920×1080
Refresh Rate	60 Hz, 59.94 Hz, 50 Hz (free run or frequency synchronization with the external reference signal(*1))
Touch Panel	Electrostatic touch panel Tapping the display shows touch keys
Key LEDs	All the keys are dimly back-lit. The selected key is lit more brightly.
Power Switch	Electronic switch (which remembers whether the instrument is on or off)
Last Memory	Backs up the panel settings to memory
Key Lock	Lock by holding down the SYS key. Prevents unintentional operations on the instrument.

*1 The LCD refresh rate changes automatically depending on the frame rate of the external reference signal.

Frame Rate of the External Reference Signal	LCD Refresh Rate
23.98Hz	Free run
24Hz	Free run
25Hz	50Hz
29.97Hz	59.94Hz
30Hz	60Hz

3. SPECIFICATIONS

3.3.16 Capturing

Screen Capture

Function	Captures the screen
Display	Displays only the captured image or overlays the captured image over the input signal
Media	Internal memory (RAM) and USB memory You can only save one screen capture to the internal memory.
Data Output	Saved to bitmap format to a USB memory device or to a file format that the instrument can load (BSG). PCAP or SDP format (SER05, SER06)
Data Input	Data saved to a USB memory device can be loaded and displayed on the instrument.

Frame Capture

Function	Captures frame data (blanking included for SDI)
Input Signal	SDI signal (SER01/02), IP signal (SER05/SER06)
Display	Displays only the captured frame data or superimposes the captured frame data over the input signal
Media	Internal memory (RAM) and USB memory Stores 1 frame or 16 consecutive frames (32 frames for some formats) in the internal memory
Data Output	Saved to DPX or TIFF format to a USB memory device or to a file format that the instrument can load (FRM). SDP format (SER05, SER06)
Data Input	Data saved to a USB memory device can be loaded and displayed on the instrument. (*1)
Capture Timing	Manual and automatic (error capture)
Error Capturing	Automatically captures frame data when an error occurs
Error Location Search	Can be searched on Frame Capture Viewer

* An input signal in the same format as the frame data is required.

3. SPECIFICATIONS

3.3.17 TSG (SER24/SER28/SER29)

Table 3-16 HD video signal formats and standards

Color System	Quantization	Image	Frame (Field) Frequency/Scanning	Supported Standard
YCbCr 4:2:2	10 bit	1280×720	60/59.94/50 /P	SMPTE ST 292-1
			30/29.97/25/24/23.98 /P	SMPTE ST 296
		1920×1080	60/59.94/50 /I	SMPTE ST 274
			30/29.97/25/24/23.98 /P	SMPTE ST 292-1
			30/29.97/25/24/23.98 /PsF	

Table 3-17 3G-A, 3G-B-DL video signal formats and standards

Color System	Quantization	Image	Frame (Field) Frequency/Scanning	Supported Standard
YCbCr 4:2:2	10 bit	1920×1080	60/59.94/50/48/47.95 /P	SMPTE ST 274
			48/47.95 /P	SMPTE ST 425-1
		2048×1080	60/59.94/50/48/47.95 /P	-
YCbCr 4:4:4	10 bit	1920×1080	60/59.94/50 /I	SMPTE ST 274
			30/29.97/25/24/23.98 /P	SMPTE ST 425-1
			30/29.97/25/24/23.98 /PsF	
		2048×1080	30/29.97/25/24/23.98 /P	SMPTE ST 425-1
			30/29.97/25/24/23.98 /PsF	SMPTE ST 2048-2
RGB 4:4:4	10 bit	1920×1080	60/59.94/50 /I	SMPTE ST 274
			30/29.97/25/24/23.98 /P	SMPTE ST 425-1
			30/29.97/25/24/23.98 /PsF	
		2048×1080	30/29.97/25/24/23.98 /P	SMPTE ST 425-1
			30/29.97/25/24/23.98 /PsF	SMPTE ST 2048-2

Table 3-18 3G(DL)-4K Video Signal Formats and Standards

Division Transmission System	Color System	Quantization	Image	Frame Frequency/Scanning	Supported Standard
Square	YCbCr 4:2:2	10 bit	3840×2160	30/29.97/25/24/23.98 /P	SMPTE ST 425-3
				30/29.97/25/24/23.98 /PsF	SMPTE ST 2036-1
			4096×2160	30/29.97/25/24/23.98 /P	-
				30/29.97/25/24/23.98 /PsF	SMPTE ST 425-3
2 sample interleave	YCbCr 4:2:2	10 bit	3840×2160	30/29.97/25/24/23.98 /P	SMPTE ST 2036-1
				4096×2160	30/29.97/25/24/23.98 /P
					SMPTE ST 2048-1

* You also need the SER28.

3. SPECIFICATIONS

Table 3-19 3G(QL) video signal formats and standards

Division Transmission System	Color System	Quantization	Image	Frame Frequency/Scanning	Supported Standard
Square	YCbCr 4:2:2	10 bit	3840×2160	60/59.94/50 /P	SMPTE ST 425-5 SMPTE ST 2036-1
				48/47.95 /P	-
			4096×2160	60/59.94/50/48/47.95 /P	SMPTE ST 425-5 SMPTE ST 2048-1
				30/29.97/25/24/23.98 /P	SMPTE ST 425-5 SMPTE ST 2036-1
			4096×2160	30/29.97/25/24/23.98 /PsF	-
				30/29.97/25/24/23.98 /P	SMPTE ST 425-5 SMPTE ST 2048-1
	YCbCr 4:4:4	10 bit	3840×2160	30/29.97/25/24/23.98 /P	SMPTE ST 425-5 SMPTE ST 2036-1
				30/29.97/25/24/23.98 /PsF	-
			4096×2160	30/29.97/25/24/23.98 /P	SMPTE ST 425-5 SMPTE ST 2048-1
				30/29.97/25/24/23.98 /PsF	-
			4096×2160	30/29.97/25/24/23.98 /P	SMPTE ST 425-5 SMPTE ST 2048-1
				30/29.97/25/24/23.98 /PsF	-
RGB 4:4:4	10 bit	3840×2160	30/29.97/25/24/23.98 /P	SMPTE ST 425-5 SMPTE ST 2036-1	
			30/29.97/25/24/23.98 /PsF	-	
		4096×2160	30/29.97/25/24/23.98 /P	SMPTE ST 425-5 SMPTE ST 2048-1	
			30/29.97/25/24/23.98 /PsF	-	
		4096×2160	30/29.97/25/24/23.98 /P	SMPTE ST 425-5 SMPTE ST 2048-1	
			30/29.97/25/24/23.98 /PsF	-	
2 sample interleave	YCbCr 4:2:2	10 bit	3840×2160	60/59.94/50 /P	SMPTE ST 425-5 SMPTE ST 2036-1
				48/47.95 /P	-
			4096×2160	60/59.94/50/48/47.95 /P	SMPTE ST 425-5 SMPTE ST 2048-1
				30/29.97/25/24/23.98 /P	SMPTE ST 425-5 SMPTE ST 2036-1
			4096×2160	30/29.97/25/24/23.98 /P	SMPTE ST 425-5 SMPTE ST 2048-1
				30/29.97/25/24/23.98 /P	SMPTE ST 425-5 SMPTE ST 2048-1
	YCbCr 4:4:4	10 bit	3840×2160	30/29.97/25/24/23.98 /P	SMPTE ST 425-5 SMPTE ST 2036-1
				30/29.97/25/24/23.98 /P	SMPTE ST 425-5 SMPTE ST 2048-1
			4096×2160	30/29.97/25/24/23.98 /P	SMPTE ST 425-5 SMPTE ST 2048-1
				30/29.97/25/24/23.98 /P	SMPTE ST 425-5 SMPTE ST 2048-1
			4096×2160	30/29.97/25/24/23.98 /P	SMPTE ST 425-5 SMPTE ST 2048-1
				30/29.97/25/24/23.98 /P	SMPTE ST 425-5 SMPTE ST 2048-1
RGB 4:4:4	10 bit	3840×2160	30/29.97/25/24/23.98 /P	SMPTE ST 425-5 SMPTE ST 2036-1	
			30/29.97/25/24/23.98 /P	SMPTE ST 425-5 SMPTE ST 2048-1	
		4096×2160	30/29.97/25/24/23.98 /P	SMPTE ST 425-5 SMPTE ST 2048-1	
			30/29.97/25/24/23.98 /P	SMPTE ST 425-5 SMPTE ST 2048-1	
		4096×2160	30/29.97/25/24/23.98 /P	SMPTE ST 425-5 SMPTE ST 2048-1	
			30/29.97/25/24/23.98 /P	SMPTE ST 425-5 SMPTE ST 2048-1	

- * You also need the SER28.
- * 3G-A and 3G-B-DL links are supported.

3. SPECIFICATIONS

Table 3-20 6G video signal formats and standards

Division Transmission System	Color System	Quantization	Image	Frame Frequency/Scanning	Supported Standard
2 sample interleave	YCbCr 4:2:2	10bit	3840×2160	30/29.97/25/24/23.98 /P	SMPTE ST 2036-1 SMPTE ST 2081-10
			4096×2160	30/29.97/25/24/23.98 /P	SMPTE ST 2048-1 SMPTE ST 2081-10

* You also need the SER28 and SER29.

Table 3-21 12G video signal formats and standards

Division Transmission System	Color System	Quantization	Image	Frame Frequency/Scanning	Supported Standard
2 sample interleave	YCbCr 4:2:2	10 bit	3840×2160	60/59.94/50 /P	SMPTE ST 2036-1 SMPTE ST 2082-10
				48/47.95/P	-
			4096×2160	60/59.94/50/48/47.95 /P	SMPTE ST 2048-1 SMPTE ST 2082-10
	YCbCr 4:4:4	10 bit	3840×2160	30/29.97/25/24/23.98 /P	SMPTE ST 2036-1 SMPTE ST 2082-10
				4096×2160	30/29.97/25/24/23.98 /P
	RGB 4:4:4	10 bit	3840×2160	30/29.97/25/24/23.98 /P	SMPTE ST 2036-1 SMPTE ST 2082-10
4096×2160				30/29.97/25/24/23.98 /P	SMPTE ST 2048-1 SMPTE ST 2082-10

* You also need the SER28 and SER29.

Output Pattern

100% color bar, 75% color bar, HD multiformat color bar (*1), 4K multiformat color bar (*1), color raster, gamma, cross hatch, 10 step, limit lamp, check field, lip sync pattern (SER03), HDR color bar (SER23) (*1)

3. SPECIFICATIONS

YCbCr/RGB on/off, Level Adjustment

When the following patterns are selected, you can turn on and off YCbCr or RGB separately.

When COLOR RASTER pattern is selected, you can set the YCbCr or RGB levels separately. Moreover, if Structure is set to RGB, You can set R, G, and B level in interlocking.

Pattern	YCbCr/RGB on/off separately	YCbCr/RGB level adjustment separately	RGB level adjustment interlocking
100% color bar	Yes		
75% color bar	Yes		
HD multiformat color bar	Yes		
4K multiformat color bar	Yes		
Color raster	Yes	Yes	Yes
Gamma	Yes		
Cross hatch	Yes		
10 step	Yes		
Limit lamp	Yes		
Check field			
Lip sync pattern			
HDR color bar	Yes		

Scrolling (*2)	ON, OFF
Direction	Eight directions (up, down, left, right, and their combinations)
Speed Range and Unit	Per frame (field) 4 to 124 dots, in 4 dot steps
Moving Box (*2)	ON, OFF
Colors	WHITE, YELLOW, CYAN, GREEN, MAGENTA, RED, BLUE, BLACK
Speed	1 to 3
Frequency Phase Adjustment (*2, *3)	
Quad link	Vary the phases of SDI OUTPUT 2 to 4 independently relative to SDI OUTPUT 1
Dual link	Vary the phase of SDI OUTPUT 2 relative to SDI OUTPUT 1 and the phase of SDI OUTPUT 4 relative to SDI OUTPUT 3
Adjustment Range	± 0.5 lines (in unit of video clocks) $\pm 1/2$ frames (in unit of lines)
Embedded Audio	
Number of Embedded Channels	16 channels max. (*4)
Embedding On/Off	On/off at the audio group level
Audio Level	-20d BFS, -18 dBFS, 0 dBFS, mute
Audio Frequency	1 kHz
CRC Error Addition	An incorrect CRC is inserted into the Y component of the first line.

*1 It cannot be set in horizontal 4096 and 2048 pixel format.

*2 Either scrolling, moving box, or frequency phase adjustment can be turned on.

*3 The output phase may be off by ± 2 clock from the specified value as a result of switching the format or turning on and off the power.

*4 For horizontal 4096/2048 pixel format at frame rates 60, 59.94, 30, 29.97 Hz, only 8 channels are embedded.

3. SPECIFICATIONS

3.3.18 25G IP TSG (SER06/SER32/SER33)

Supported IP Standard

IP Formats SMPTE ST 2022-6, SMPTE ST 2110-20/22/30/40
Synchronization Mode PTP (SMPTE ST 2059)

Supported IP Formats

Table 3-22 IP video signal formats and standards

Color System	Quantization	Image	Frame (Field) Frequency/ Scanning	Supported Standard	Compression Ratio
Y _C B _C R _R 4:2:2	10bit	1280×720	60/59.94/50/ 30/29.97/25/24/23.98 /P	SMPTE ST 2022-6 SMPTE ST 2110-20	-
				SMPTE ST 2110-22 (JPEG XS)	40:1 to 2:1 (0.5 to 10.0 bpp)
		1920×1080	60/59.94/50 /I 60/59.94/50/ 30/29.97/25/24/23.98 /P 30/29.97/25/24/23.98 /PsF	SMPTE ST 2022-6 SMPTE ST 2110-20	-
				SMPTE ST 2110-22 (JPEG XS)	40:1 to 2.5:1 (0.5 to 8.0 bpp)
		3840×2160 (*1)	60/59.94/50/ 30/29.97/25/24/23.98 /P	SMPTE ST 2110-20	-
				SMPTE ST 2110-22 (JPEG XS)	40:1 to 5:1 (0.5 to 4.0 bpp)

Output Pattern 100% color bar, 75% color bar, multiformat color bar, lip sync pattern (to be supported in the future)

Audio Signal 1 KHz audio signal complying with SMPTE ST 2110-30

Supported Protocol IPv4 (Internet Protocol version 4)
IGMPv2/v3 (Internet Group Management Protocol)
NMOS (IS-04/05) (*2)

IP Packet Emulation

Function Adds jitter and checksum error to the SMPTE ST 2110-20 test signal.

Error FCS ERROR, IP CS, UDP CS

Jitter (*3, 4, 5, 6) 1 packet, 10 packet, 20 packet, 30 packet, 40 packet, 50 packet, 60 packet, 70 packet, 80 packet, 90 packet, 100 packet

* You also need the SER06.

* Error and jitter are added on the output from port 1.

*1 For 4K, only a single stream is supported. You also need the SER28.

*2 For NMOS control, the instrument's Ethernet port is used.

*3 In outputting 4K signal, you can set up to 20 packets.

*4 The packet jitter depends on the output signal format.

*5 The packet jitter may be off by ±10%.

*6 The RTP time stamp causes twice delay of the packet transmission interval.

3. SPECIFICATIONS

3.3.19 Presets

Preset	Saves panel settings (with a few exceptions)
Number of Presets	60
Preset Loading Method	Front panel or remote connector (*1)
Copying	All preset data can be copied from the instrument to a USB memory device or from a USB memory device to the instrument.

*1 The number of presets loaded from the remote connector can be 8 or 60.

3.3.20 Display

Number of simultaneously displayed SDI input signals

SD, HD, 3G-A, 3G-B-DL	4
HD(DL)	2
3G-B DS	1
3G(DL)-2K	2
3G(DL)-4K (SER28)	1
HD(QL) (SER28)	1
3G(QL) (SER28)	1
6G (SER28/SER29)	1
12G (SER28/SER29)	1

Number of Display Systems in the IP Input Signal (SER05/SER06)
1

Display Mode

Single display	Displays a single input signal
Simul Display	Displays two or more input signals simultaneously SDI and IP can be displayed simultaneously. (*1)

Display Assignment Mode (SER26)

Maps the input video signal of a channel to multiple areas (*2)

Alarm Indications

System Alarm Indication	Displays an alarm when the fan malfunctions or when the internal temperature is abnormal
Error Indication	Displays an error when an receive signal error occurs

3. SPECIFICATIONS

Display Layout	
Multi Display	Control the WFM/PIC and other display functions in multiple areas from a single screen
Customized Layout (SER26)	
Function	Freely arrange the windows shown with the WFM, VECT, PIC, AUDIO, STATUS, and EYE (SER02/SER02A) keys (one of each), and a window consisting of six displays shown with MULTI
Display Format	Displays up to four single link input signals in tiled, mixed, V aligned, or H aligned mode.
Normal Mode	Each display area is divided evenly.
Tiled Display	The windows are divided into four quadrants.
Mixed Display	The windows are cascaded.
V Aligned Display	The windows are arranged top to bottom.
H Aligned Display	The windows are arranged side by side.
Tile Mode	The display contents arranged in the display are shown in four quadrants per screen.
V Aligned Mode	The display contents arranged in the display are shown in four vertical divided windows per screen.
H Aligned Mode	The display contents arranged in the display are shown in four horizontally divided windows per screen.
Enhanced Layout (SER26)	
Function	When multiple channels of single link are displayed, the selected channel is automatically shown in a specific area. You can make the specific area larger than the other areas to show the selected channel enlarged.
3G-B DS Display Format	
Aligned Display	The screen is divided into windows.
Time Display	
Displayed Contents	Current time, time code
Current Time Display	The time based on the internal clock
Time Code Display	LTC, VITC, D-VITC (SD only), PTP
Supported Standard	
LTC, VITC	SMPTE ST 12-2
D-VITC	SMPTE ST 266
Tally Display	
Remote Connector	Turn on and off the tally display by controlling through the remote connector
RS-485 Control (SER27)	Shows tallies through RS-485 control
Camera ID Display	
Instrument Setting	Shows the camera ID set with the instrument's menu
RS-485 Control (SER27)	Shows the camera ID through RS-485 control
Iris Display	
RS-485 Control (SER27)	Shows the iris through RS-485 control

3. SPECIFICATIONS

- *1 IP signals can be displayed when the SDI system is set to 2K SD/HD/3G-A/3G-B-DL.
- *2 Simultaneous display of HDR (SER23) and normal picture or CINEZONE and normal picture is possible. However, there is a limit to the number of channels that can be displayed. This can be set only for SD/HD/3G-A/3G-B-DL single link. It cannot be set for 4K signals or SDI system that transmits multiple lines.

3.3.21 Video Signal Waveform Display

Waveform Control

Display Mode

Overlay	Overlays component signals
Parade	Displays component signals side by side
Blanking Interval	H and V blanking periods can be masked.
RGB Conversion	Converts a YC _B C _R signal into an RGB signal and displays the result
Channel Assignment	GBR or RGB order
Pseudo-Composite Display	Artificially converts component signals into composite signals and displays the result
Line Select	Displays the selected line
Sweep Modes	H, V
Color	7 colors to choose from

Vertical Axis

Gain	×1, ×5, ×10
Variable Gain	
Gain x1	×0.2 to ×2.0
Gain x5	×1.0 to ×10.0
Gain x10	×2.0 to ×10.0
Amplitude Accuracy	±0.5% (single default display)
3G, HD(DL) (1080/60P, 1080/59.94P, 1080/50P)	
Y Signal	±0.5 % (1 to 60 MHz)
C _B C _R Signal	±0.5 % (0.5 to 30 MHz)
Low-Pass Attenuation	≥ 20 dB (at 40 MHz)
3G, HD, HD(DL) (1080/60P, 1080/59.94P, 1080/50P)	
Y Signal	±0.5 % (1 to 30 MHz)
C _B C _R Signal	±0.5 % (0.5 to 15 MHz)
Low-Pass Attenuation	≥ 20 dB (at 20 MHz)
SD	
Y Signal	±0.5 % (1 to 5.75 MHz)
C _B C _R Signal	±0.5 % (0.5 to 2.75 MHz)
Low-Pass Attenuation	≥ 20 dB (at 3.8 MHz)

3. SPECIFICATIONS

Horizontal Axis	
Line Display	
Display Format	Overlay (1H, 2H) (*1) Parade (1H, 2H, 3H) 4Y parade (4H)
Magnification	×1, ×10, ×20, ACTIVE, BLANK
Field Display	
Display Format	Overlay (1V, 2V) (*2) Parade (1V, 2V, 3V)
Magnification	×1, ×20, ×40
Time Accuracy	±0.5% (single default display)
Cursor Measurement	
Composition	
Horizontal Cursors	2 (REF and DELTA)
Vertical Cursors	2 (REF and DELTA)
Simultaneous Display	Displays the horizontal cursors and vertical cursors simultaneously
Amplitude Measurement	mV, %, R%, DEC, HEX
Time Measurement	Second display
Frequency Display	Computes and displays the frequency with the length of one period set to the time between two cursors
Cursor Value Display	Displays measured values at the cursors
Scale	
Type	%, V, decimal, hexadecimal
Display Colors	7 colors to choose from
HDR Scale (SER23)	Adds an HDR scale to each scale for HDR
External Sync Signal Waveform Display	
Compatible SDI Systems	Can be displayed for SD, HD, 3G-A, and 3G-B-DL
Features	Waveform display of external sync signal
Vertical Axis	
Gain	×1
Variable Gain	CAL
Horizontal Axis	
Line Display	
Display Format	1H, 2H
Magnification	×1
Field Display	
Display Format	1V, 2V
Magnification	×1
Scale	
Type	%
Display Colors	7 colors to choose from

*1 2H display is not possible when the input signal is 4K.

*2 2V display is not possible when the input signal is progressive.

3. SPECIFICATIONS

3.3.22 Vector Display

Vector Mode	Vector, RGB vector (SER40), YCbCr vector (SER40)
Display Colors	7 colors to choose from
Blanking Interval	H and V blanking periods can be masked (according to the video signal waveform display settings).
Pseudo-Composite Display	Artificially converts component signals into composite signals and displays the result
Line Select	Displays the selected line
Gain	×1, ×5, IQ-MAG
Variable Gain	
Gain x1	×0.2 to ×2.0
Gain x5	×1.0 to ×10.0
Gain IQ-MAG	
Not SD, component display	0.620 to 6.240
SD, component display	0.580 to 5.840
Not SD, pseudo-composite display	0.570 to 5.700
SD, pseudo-composite display	0.520 to 5.260
Amplitude Accuracy	±0.5 %
Scale	
Type	AUTO, ITU-R BT.601, ITU-R BT.709, DCI, ITU-R BT.2020
Color Bar Saturation	75 %, 100 %
IQ Axis	Show or hide
ARIB Check Marker	OFF, STD-B66, STD-B72
Display Colors	7 colors to choose from
Variable Scale	ON, OFF
Color Wheel	ON, OFF
Vector Marker Display	Displays a marker and numeric value at the specified location on the vector display
Number of Markers	1
Numeric Display	Displays the marker position numerically
Cb	Displays the C_B position as a percentage
Cr	Displays the C_R position as a percentage
deg	Displays the hue in degrees.
d	Displays the distance from the center as a percentage
Variable Marker	Marker and frame resizing

3. SPECIFICATIONS

Histogram Display	Displays the Y, R, G, and B histograms
5-Bar Display	
Function	Converts an SDI signal into Y, R, G, B, and composite values, and then displays the five peak levels.
Channel Assignment	RGB, GBR
Scale	%, mV, HEX, DEC
Error Level	Based on the gamut error, composite gamut error, and luminance error thresholds
Line Select	Displays the selected line
Low-Pass Filter	The same as for gamut errors

3.3.23 Picture Screen

Quantization	8 bit (internal signal processing is performed with signed 12 bit or higher)
Level Mapping	Maps the black level to 0 (8bit), SDI code value (when receiving 10 bit RGB) 1024 to 255 (8 bit)
Display Sizes	Reduced, actual size, ×2 (4K not supported), full frame (4K not supported)
Quality Adjustment and Color Selection	Brightness, contrast, RGB gain, RGB bias, chroma gain, monochrome display (RGB gain, RGB bias, chroma gain not valid)
Frame Rate	Converts the frame rate based on the LCD frame rate (60P, 59.94P, 50P)
SCTE-104 Display	
Function	SCTE-104 message monitoring
Supported Standard	SMPTE 2010, ANSI/SCTE 104
Supported Format	For Dual / Quad Link, Link1 only (Link cannot be changed)
Supported Input Channel	SDI INPUT 1 / 2 / 3 / 4 (DS1 only)
Display	Superimpose when SCTE-104 message is detected
Display Location	OFF / Top left / Top right / Bottom left / Bottom right
Display Time	1 to 10 seconds (1 second step)
SPLICE Display	When a splice_request_data message is detected, the details of the message are displayed
Aspect Marker Display	
3G (17:9 aspect ratio)	16:9, 14:9, 13:9, 4:3, 2.39:1
3G (16:9 aspect ratio), HD, HD(DL)	17:9, 14:9, 13:9, 4:3, 2.39:1, AFD (*1)
SD	16:9, 14:9, 13:9, AFD (*1)
Aspect Marker Format	Line, shadow (99 levels), or black
Safety Marker Size	ARIB TR-B4, SMPTE RP-218, or user-defined
AFD Display (*1)	Displays abbreviations for SMPTE ST 2016-1-2007 standard AFD codes
Line Select	Marks the selected line
Error Indication	Displays markers in the gamut error and level error areas

*1 AFD Supports only SD or HD.

3. SPECIFICATIONS

3.3.24 Colorimetry Zone Display (SER31)

Function	Colors in the ITU-R BT.2020 color gamut and outside the ITU-R BT.709 or DCI color gamut are displayed as a mesh pattern on the picture.
Color Gamut Selection	Selects the color gamut inside the colorimetry zone display ITU-R BT.709 / DCI
Mesh Pattern Size	×1, ×2, ×4, ×6, ×8
Display Selection	Color, monochrome
Log	Records as the event log when a color outside the ITU-R BT.709 or DCI color gamut exists inside the ITU-R BT.2020 color gamut.

3.3.25 Superimpose Display

Displays English closed captions, European closed captions, and Japanese closed captions over the picture

English Closed Caption

Supported Standards (Mapping Standards)

EIA-708 SMPTE ST 334

EIA/CEA-608-B (EIA-708-B)

SMPTE ST 334

EIA/CEA-608-B (EIA/CEA-608-B)

SMPTE ST 334

VBI (EIA/CEA-608-B Line21)

CIA/EIA-608-B

Supported Video Formats SD, HD, 3G-A, 3G-B-DL,
HD(DL) (close caption decoding only for link A),
3G(DL)-4K (close caption decoding only for link 1),
HD(QL) (close caption decoding only for link 1),
3G(QL) (close caption decoding only for link 1),
6G (close caption decoding only for sub 1),
12G (close caption decoding only for sub 1)

European Closed Caption

Supported Standards

Teletext VBI (ITU-R BT. 653-3 System B) (SD only), OP47

3. SPECIFICATIONS

Simple Japanese Closed Caption Display

	Displays a simple Japanese closed caption on the picture display. (Select HD, SD, analog, or portable closed caption to display. Select language 1 or 2.)
Supported Standard	ARIB STD-B37 short form data
Supported Video Formats	SD, HD, 3G-A, HD(DL) (close caption decoding only for link A), 3G(DL)-4K (close caption decoding only for link 1), HD(QL) (close caption decoding only for link 1), 3G(QL) (close caption decoding only for link 1), 12G (close caption decoding only for sub 1)
Display	Display position control is supported only for HD and SD closed captions.
Characters	Only Kanji, roman numerals, katakana, hiragana, additional characters (ARIB STD-B24), additional kanji (ARIB STD-B24), and 1-byte DRCS are displayed.
Character Sizes	Supports only standard, medium, small, and specified size codes
Logging	
Logged Events	Clear screen command, text closed caption display event, time code, TV commercial material check result
Data Format	Text
TV Commercial Material Checking	
Function	Checks whether closed caption displays are present during the closed caption prohibited time
Check Period	The material start time and end time can be specified using timecodes.
Log Display Color	
Closed Caption during Prohibited Time	Red
Closed Caption Not during Prohibited Time	Green
Check Result Display	Displays OK or NG when measurements are complete
Loudness Synchronization (SER03)	Simultaneous measurement with loudness measurement

3. SPECIFICATIONS

3.3.26 CINELITE Display

Function	Video levels are displayed numerically.
f Stop Display (not supported on the SER23)	Displays f Stop values relative to a reference point Set in reference to an object with an 18% reflectance f Stop gamma correction
Fundamental Gamma	ITU-R BT.709, hybrid log gamma (HLG) (SER23), PQ (SER23), S-Log3 (SER23)
User Correction Table	3 types (data acquired with a real device)
% Display (SDR)	Displays the luminance level or RGB level as a percentage with the SDI code value 64 assumed to be 0% and the SDI code value 940 assumed to be 100%
Gradation Display	Displays the luminance or RGB value with the SDI code value 64 assumed to be 0 and the SDI code value 940 assumed to be 255
CV Display	Decimal, hexadecimal Displays the SDI signal code value as YCBCR or RGB according to the input signal (only for measurement size 1×1)
HDR Display (SER23)	
HLG	
System Gamma OFF	
Narrow Range	Displays the relative HLG luminance with the SDI code value 64 assumed to 0% and 940 assumed to be 1200% or 100%
Full Range	Displays the relative HLG luminance with the SDI code value 0 assumed to 0% and 1023 assumed to be 1200% or 100%
System Gamma ON	Assuming a Display with a peak brightness of 1000 Nits
Narrow Range	Displays the relative HLG luminance with the SDI code value 64 assumed to 0 Nits and 940 assumed to be 1000 Nits
Full Range	Displays the relative HLG luminance with the SDI code value 0 assumed to 0 Nits and 1023 assumed to be 1000 Nits

3. SPECIFICATIONS

PQ	Converts the luminance level to the display's Nits and displays the result
Narrow Range	SDI code value 64 to 940 are assumed to be 0 Nits to 10000 Nits
Full Range	SDI code value 0 to 1023 are assumed to be 0 Nits to 10000 Nits
S-Log3	Converts the reflectance to IRE with SDI code value 95 assumed to be 0% and 589 assumed to be 100% and displays it as a percentage
C-Log	Displays the percentage with the SDI code value 128 assumed to 0% and 614 assumed to be 100%
Log-C	
EI200	Displays the percentage with the SDI code value 95 assumed to 0.39% and 853 assumed to be 83%
EI400	Displays the percentage with the SDI code value 95 assumed to 0.39% and 917 assumed to be 90%
EI800	Displays the percentage with the SDI code value 95 assumed to 0.39% and 976 assumed to be 95%
EI1600	Displays the percentage with the SDI code value 95 assumed to 0.39% and 1022 assumed to be 94%
Measured Points	3
Measurement Sizes	1 × 1 pixel, 3 × 3 pixels, and 9 × 9 pixels

3.3.27 CINELITE Advanced Display

Function	Synchronizes the markers on the waveform display, vector display, and chromaticity diagram display to the points selected with CINELITE
Waveform Display Link Markers	Synchronizes the markers on the waveform display to the points selected with CINELITE
Number of Link Markers	Up to 16 (for YRGB, YGBR display) (including the 4 reference points)
Vector Link Markers	Synchronizes the markers on the vector display to the points selected with CINELITE
Number of Link Markers	Up to 4 (including the 1 reference point)
Vector Numeric Display	Displays numerically the active marker position
Cb	Displays the CB position as a percentage
Cr	Displays the CR position as a percentage
deg	Displays the hue as an angle (°).
d	Displays the distance from the center as a percentage
CIE Chromaticity Diagram Display Link Markers	Synchronizes the markers on the CIE chromaticity diagram display to the points selected with CINELITE
Number of Link Markers	Up to 4 (including the 1 reference point)

3. SPECIFICATIONS

3.3.28 CINEZONE Display

SDR Display

Gradation and Step

Function

Adds colors to the display in accordance with luminance levels

Display Colors

Linear (1024 colors), step (12 colors)

Upper Limit

-6.3 to 109.4 % (values equal to or greater than the upper limit are displayed in white)

Lower Limit

-7.3 to 108.4 % (values less than the lower limit are displayed in black)

Search

Function

Monochrome display of the set luminance level range
Color display within $\pm 0.5\%$ of the set luminance level

Display Colors

Green

Level Setting

-7.3 to 109.4%

Upper Limit

-6.3 to 109.4% (values equal to or greater than the upper limit are displayed in red)

Lower Limit

-7.3 to 108.4% (values less than the lower limit are displayed in blue)

HDR Display (SER23)

Function

Adds colors to the display in accordance with luminance levels

HDR Area Setting

Displays color according to the brightness

SDR Area Setting

Monochrome display

Upper Limit

Displays magenta for values exceeding the limit
Ref.LEVEL to 100% (code values 64 to 940 or 0 to 1023 assumed to be 100%)

Lower Limit

Displays black for values less than the limit
0% to Ref.LEVEL% (code values 64 to 940 or 0 to 1023 assumed to be 100%)

3.3.29 Focus Assist (SER25)

Detection Sensitivity

LOW, MIDDLE, HIGH

Highlight Display Color

WHITE, GREEN, BLUE, RED

Picture Luminance Level

OFF, EMBOSS, 25%, 50%, 75%, 100%

3. SPECIFICATIONS

3.3.30 CIE Chromaticity Diagram Display

Display Standard	CIE1931 (xy display), CIE1976 (u'v' display)
Display Type	Chromaticity diagram display, color temperature display
Display Mode	
Chromaticity Diagram Display	Luminance display, color display
Color Temperature Display	Luminance display
Colorimetry	ITU-R BT.601 (525), ITU-R BT.601 (625), BT.709, DCI, ITU-R BT.2020
Clipping	
ON	Clips negative values of the input signal to zero
OFF	Displays negative values of the input signal according to ITU-R BT.1361
Smoothing	Displays by averaging data every two pixels
Accuracy	±0.005 (relative to the measurement coordinate value)
Chromaticity Diagram Display Scale	
Triangle	Select two from ITU-R BT.601 (525), ITU-R BT.601 (625), ITU-R BT.709, DCI, and ITU-R BT.2020
User-defined Triangle	Set a single user-defined triangle
Background	Color sample, white background, black background
Sub scale	Color temperature curve, grid (0.1 steps), white point (D65), triangle name (each can be turned on or off)
Cursor	Displays the cursor position in coordinates
Gamma	ITU-R BT.709, user (1.5 to 3.0), HLG (SER23), PQ (SER23), S-Log3 (SER23), C-Log (SER23), Log-C (SER23)

3. SPECIFICATIONS

3.3.31 Video noise measurement (SER30)

Measurement Function

Measured Signal	Select Y, G, B, or R.
Measurement Area	Set the size and position of the area to be measured
Noise Level Display	mVrms, dB
Alarm Function	Displays measured values in red when the values exceed the specified threshold

Low-Pass Filter -12 dB±1 dB at the cutoff frequencies in the following table

Format	Cutoff frequencies						
	5.5MHz	4.4MHz	3.6MHz	2.7MHz	1.4MHz	0.7MHz	Through
SD 720×487	5.5MHz	4.4MHz	3.6MHz	2.7MHz	1.4MHz	0.7MHz	Through
SD 720×576	5.5MHz	4.4MHz	3.6MHz	2.7MHz	1.4MHz	0.7MHz	Through
HD 1280×720	30MHz	24MHz	20MHz	15MHz	7.5MHz	3.7MHz	Through
HD 1920×1080 (frame rate ≤ 30 Hz)	30MHz	24MHz	20MHz	15MHz	7.5MHz	3.7MHz	Through
HD 1920×1080 (frame rate > 30 Hz)	60MHz	48MHz	40MHz	30MHz	15MHz	7.5MHz	Through
HD 2048×1080 (frame rate ≤ 30 Hz)	30MHz	24MHz	20MHz	15MHz	7.5MHz	3.7MHz	Through
HD 2048×1080 (frame rate > 30 Hz)	60MHz	48MHz	40MHz	30MHz	15MHz	7.5MHz	Through
4K 3840×2160 (frame rate ≤ 30 Hz)	120MHz	96MHz	80MHz	60MHz	30MHz	15MHz	Through
4K 3840×2160 (frame rate > 30 Hz)	240MHz	192MHz	160MHz	120MHz	60MHz	30MHz	Through
4K 4096×2160 (frame rate ≤ 30 Hz)	120MHz	96MHz	80MHz	60MHz	30MHz	15MHz	Through
4K 4096×2160 (frame rate > 30 Hz)	240MHz	192MHz	160MHz	120MHz	60MHz	30MHz	Through

Passband Ripple ±0.5dB

High-Pass Filter -12 dB±1 dB at the cutoff frequencies in the following table

Format	Cutoff frequencies	
	ON	OFF
SD 720×487	36kHz	Through
SD 720×576	36kHz	Through
HD 1280×720	200kHz	Through
HD 1920×1080 (frame rate ≤ 30 Hz)	200kHz	Through
HD 1920×1080 (frame rate > 30 Hz)	400kHz	Through
HD 2048×1080 (frame rate ≤ 30 Hz)	200kHz	Through
HD 2048×1080 (frame rate > 30 Hz)	400kHz	Through
4K 3840×2160 (frame rate ≤ 30 Hz)	800kHz	Through
4K 3840×2160 (frame rate > 30 Hz)	1.6MHz	Through
4K 4096×2160 (frame rate ≤ 30 Hz)	800kHz	Through
4K 4096×2160 (frame rate > 30 Hz)	1.6MHz	Through

Passband Ripple ±0.5dB

Measurement Accuracy (when filters are not applied)

0 to -65.00dB	±0.3dB
-65.01 to -70.00dB	±0.7dB
-70.01 to -75.00dB	±2.0dB

3. SPECIFICATIONS

3.3.32 HDR Display (SER23)

Supported Standard	ITU-R BT.2100 (HLG: Hybrid Log Gamma, Full range / Narrow range), ITU-R BT.2100 (PQ: Perceptual Quantization, Full range / Narrow range), S-Log3, C-Log, Log-C
Supported Formats	All formats except SD-SDI
Function	
Video Waveform Display	Scale, cursor
Vector Display	Histogram
Picture Screen	
HDR CINEZONE	
HDR CINELITE	
MAX CLL, MAX FALL (CEA-861 Supported)	Supports HLG and PQ
START	MAX CLL, MAX FALL computation start
STOP	MAX CLL, MAX FALL computation stop
MAX CLL, MAX FALL Error	When the measurement result is equal to or greater than the specified threshold, it is displayed turns red and recorded as the event log.

3.3.33 Audio Display

Input Signal	SDI embedded audio Digital audio I/O connector (SER03) Analog audio input (SER03) SFP IP Audio (SER05/SER06)
Format	L-PCM, Dolby-E (SER04), Dolby Digital (SER04), Dolby Digital Plus (SER04)
Sampling Frequency	48 kHz
Quantization	24 bit
SDI Embedded Audio	
Supported Standard	
2K (except SD), 4K	SMPTE ST 299
SD	SMPTE ST 272
Clock Generation	Generated from the video clock
Synchronization	Must be synchronized to the video clock. All SDI signals must be synchronized.
Channel Separation	
Single Input Mode	Separates up to two groups (8 channels) from any SDI input.
Simul Mode (2K SD/HD/3G-A/3G-B-DL)	Separates up to four groups (8 channels) from any SDI input.
Channel Separation (SER03)	Separates up to four groups (16 channels) from any SDI input. (For 3G, channels 1 to 16 and channels 17 to 32 are divided.)

3. SPECIFICATIONS

IP Input (SER05/SER06)

Clock Generation System Generated from the video clock

Synchronization Relationship

Must be synchronized to the video clock.

All the content video signals must be synchronized.

Channel Separation

Single Input Mode Separates up to two groups (8 channels) from any IP input.

Simul Mode (2K SD/HD/3G-A/3G-B-DL)

Separates up to four groups (8 channels) from any IP input.

Channel Separation (SER03)

Separates up to four groups (16 channels) from any SDI input.

(For 3G, channels 1 to 16 and channels 17 to 32 are divided.)

Maximum Number of Display Channels

SDI embedded audio signal (SER03)

16 (from any SDI input, displayed in groups)

External Audio Signals (SER03)

16 (A, B)

Analog Audio Signals (SER03)

8

Dolby Signals (SER04)

8 (A, B)

Decodes SDI embedded audio or external audio signal and displays 8 channels

IP Input Audio Signal (SER05/SER06)

8 (from any IP input, displayed in groups)

IP Input Audio Signal (SER03/SER05/SER06)

16 (from any IP input, displayed in groups)

Display Types

Level meter, Lissajous (SER03), correlation meter (SER03), surround (SER03), status (SER03), loudness (SER03)

3. SPECIFICATIONS

Level meter	
Displayed Channels	8 channels
Displayed Channels (SER03)	8 channels, 16 channels
Dynamic Range	
SDI Embedded Audio	SDI-60 dBFS, -90 dBFS, reference level±3 dB
External Digital Audio (SER03)	-60 dBFS, -90 dBFS, reference level±3 dB
External Analog Audio (SER03)	-60dBFS, reference level±3 dB
Level Accuracy	Scales the scale reference level 4dBu to -20dBFS ±0.3 dB (-50 to 0 dBFS, 1 kHz, signal source impedance 40 Ω or less)
Frequency Response	30 Hz to 20 kHz ± 0.4 dB (4 dBu, 1 kHz reference, TRUE PEAK response) 20 Hz to 20 kHz + 0.4 dB, -0.6 dB (4 dBu, 1 kHz reference, TRUE PEAK response)
Meter Response Model	TRUE PEAK, PPM type I , PPM type II , VU
Peak Hold Time	0.0 to 5.0 s (in 0.5 s steps), HOLD
Level Setting	-40.0 to 0.0 dBFS (standard level, warning level, over level)
Level Numeric Display	Displays the levels numerically Numeric display in red when level-over is detected Displays a blue "M" when mute is detected (ON/OFF selectable. The displays changes to a blue ■ when the layout size is small.) Displays "U.L" when audio is not detected
Dolby Detection (SER04)	Displays a cyan ■ for Dolby audio channels Displays "DOLBY" in green for decode selection channels

3. SPECIFICATIONS

Lissajous Display (SER03/SER04)

Displayed Channels	2 channels × 1 2 channels × 4 2 channels × 8
Display Mode	X-Y, MATRIX
Correlation Meter	Displays the correlation between two channels as a value from -1 to 1
Channel Assignment	
SINGLE LISSAJOU	L, R
MULTI LISSAJOU	L1, R1 to L4, R4 to L8, R8
Indicator Display	Displays Dolby E frame locations with indicators

Surround Display (SER03/SER04) (*1)

Function	Displays a graphical representation of a sound field
Surround Format	5.1 channels
Channel Mapping	L, R, C, LFE, Ls, Rs, Lt, Rt
Center Channel Format	NORMAL, PHANTOM CENTER
Gain	×1, AUTO
Indicator Display	Displays Dolby E frame locations with indicators

Status Display (SER03/SER04)

Level	Audio levels are displayed using numbers (dBFS).
Error Detection	Counts the number of errors that occur for each channel
Level Over	Counts the number of times that the level of the input signal exceeds the set value
Detection Setting	-40.0 to 0.0 dBFS
Clipping	Counts the number of times that a received signal exceeds the maximum signal value for the specified number of consecutive samples
Detection Setting	1 to 100 sample
Mute	Counts the number of times that the length of a received mute signal exceeds the specified period
Detection Setting	1 to 5000 ms
Parity Error	Counts the number of times that the input signal's parity bit and the parity bit recalculated by the instrument differ
Validity Error	Counts the number of times that the input signal's validity bit is 1
CRC Error	Counts the number of times that the CRC of the channel status bits and the calculated CRC are different
Code Violation	Counts the number of times that the state of the input signal's biphase modulation is abnormal
Elapsed Time	Displays the amount of time that has elapsed since the instrument was reset
Channel Status Bits	Dump display, text display
User Data Bits	Dump Display
DOLBY Metadata	Text display
Dolby E Frame Location	Displays the header position and mode

3. SPECIFICATIONS

Loudness Display (SER03)

Function	Loudness chart display, numeric display, log, level meter display, peak value display
Supported Standard	ITU-R BS.1770, ARIB TR-B32, EBU R128, ATSC A/85
Measurement Channel	Simultaneous measurement of two audio sources
Mode (Main)	Monaural, stereo, 5.1, user specified channel
Mode (Sub)	Off, monaural, stereo
Channel Selection	User-defined assignment of eight channels
LFE Gain	0 to 10 times
Measurement Trigger	Manual (panel), remote, timecode, mute
Measurement Mode	BS1770, ARIB, EBU, ATSC, CUSTOM
Target Level	
BS1770	-24.0 LKFS
ARIB	-24.0 LKFS (±1 LK)
EBU	-23.0 LUFS (LIVE ON ±1 LU / LIVE OFF ±0.5 LU)
ATSC	-24.0 LKFS (±2 LK)
CUSTOM	-25.0 to -23.0 LKFS
Average Time	
Momentary Loudness	200 to 10000 ms
Short-term Loudness	200 to 10000 ms
Chart Display	
1 During Audio Measurement	Graph display of integrated loudness and momentary or short-term loudness
2 During Audio Measurement	Graph display of integrated, momentary, or short-term loudness
Measurement Time	2min, 10min, 30min, 1hour, 2hour, 6hour, 12hour, 24hour
MAG	Zoomed display of the target level from -18 to +9 (LK/LU)
Numeric Display	Absolute value and relative value displays of integrated loudness and momentary or short-term loudness
Integrated Loudness	Displayed in red when the target level range is exceeded
Momentary, Short-term Loudness	Displayed in red when the target level is exceeded
Log	
Log Time	Up to 24 hours
File	
Log	Saves gating block loudness in CSV format
Summary	Saves settings and measurement results in text format
Level Meter Display	Displays level meters for eight channels
Peak Value Display	Displays peak values of a measurement channel numerically

*1 Only CH Mode 8 channels is supported.

3. SPECIFICATIONS

3.3.34 Status Display

Signal Detection	Detects the presence of an SDI signal
Format Display	Displays the video signal format
Frequency Deviation Display (not displayed for IP signals)	
Function	Displays the sampling frequency deviation Displays an error if ± 10 ppm is exceeded
Measurement Range	± 100 ppm
Precision	± 2 ppm
Equivalent Cable Length Display (not displayed for IP signals)	
Function	Displays SDI signal attenuation in terms of cable length Displays an error if the specified cable length is exceeded
Supported Cables	
12G	L-5.5CUHD
3G, HD	LS-5CFB, 1694A
SD	L-5C2V, 8281
Display Range	
12G	< 10 m, 10 to 80 m, > 80 m
3G	< 10 m, 10 to 100 m, > 100 m
HD	< 10 m, 10 to 130 m, > 130 m
SD	< 50 m, 50 to 200 m, > 200 m
Precision	
12G, 3G, HD	± 20 m
SD	± 30 m
Resolution	10 m
Error Count Display	Up to 999999 errors for each error type
Count Period	1 second, 1 field (frame)
Embedded Audio Channel Display	Displays the embedded audio channel numbers

* If the input signal is 3G-B-DL, only stream 1 is supported.

SDI Signal Error Detection

CRC Error	Detects 3G and HD signal transmission errors
EDH Error	Detects SD signal transmission errors
TRS Position Error	Detects TRS embedding position errors
TRS Code Error	Detects TRS protection bit errors
Line Number Error	Detects errors with the line numbers embedded in 3G and HD signals
Illegal Code Error	Detects data within the range of 000 to 003h and 3FC to 3FFh in locations other than TRS and ADF

* IP signals comply only with ST2022-6.

3. SPECIFICATIONS

Embedded Audio Packet Error Detection (*1)

BCH Error	Detects audio packet transmission errors
Parity Error	Detects audio packet parity errors
DBN Error	Detects audio packet continuity errors
Embedded Position Error	Detects the presence of audio in lines where it should not be embedded
Sample Counter Error	Detects asynchronous audio by measuring the number of audio samples

* IP signals comply only with ST2022-6.

*1 If the input signal is 3G-B-DL, only stream 1 is supported.

Ancillary Data Packet Error Detection

Checksum error	Detects ancillary data transmission errors
Parity Error	Detects ancillary data header parity errors

* IP signals comply only with ST2022-6.

Video Error Detection

Freeze Error	Detects freezing of video within the specified time range
Detection Method	Video interval checksum
Time Specification	2 to 300 frames
Black Error	Detects video blackouts
Black Level Specification	0 to 100%
Area Specification	1 to 100%
Time Specification	1 to 300 frames
Level Error	Detects luminance level errors and chrominance level errors
Luminance Level Detection Range	
Upper limit	-51 to 766 mV
Lower Limit	-51 to 766 mV
Chrominance Level Detection Range	
Upper limit	-400 to 399 mV
Lower Limit	-400 to 399 mV

3. SPECIFICATIONS

Gamut Error Detects gamut errors
 Detection Range
 Upper limit 90.8 to 109.4%
 Lower Limit -7.2 to 6.1%

Low-Pass Filter

Format	Low-Pass Filter	
	HD/SD: 1 MHz	HD: 2.8 MHz SD: 1 MHz
SD 720×487	Approx. 1 MHz (EBU R103-2000)	Approx. 1 MHz
SD 720×576	Approx. 1 MHz (EBU R103-2000)	Approx. 1 MHz
HD 1280×720	Approx. 1 MHz	Approx. 2.8 MHz
HD 1920×1080 (frame rate ≤ 30 Hz)	Approx. 1 MHz (IEEE STD 205)	Approx. 2.8 MHz
HD 1920×1080 (frame rate > 30 Hz)	Approx. 2 MHz	Approx. 5.5 MHz
HD 2048×1080 (frame rate ≤ 30 Hz)	Approx. 1 MHz (IEEE STD 205)	Approx. 2.8 MHz
HD 2048×1080 (frame rate > 30 Hz)	Approx. 2 MHz	Approx. 5.5 MHz
4K 3840×2160 (frame rate ≤ 30 Hz)	Approx. 4 MHz	Approx. 11 MHz
4K 3840×2160 (frame rate > 30 Hz)	Approx. 8 MHz	Approx. 22 MHz
4K 4096×2160 (frame rate ≤ 30 Hz)	Approx. 4 MHz	Approx. 11 MHz
4K 4096×2160 (frame rate > 30 Hz)	Approx. 8 MHz	Approx. 22 MHz

Area Specification 0.0 to 5.0%

Time Specification 1 to 60 frames

Composite Gamut Error Detects level errors that occur when component signals are converted to composite signals

Detection Range

Upper limit 90.0 to 135.0%

Lower Limit -40.0 to 20.0%

Low-Pass Filter The same as the gamut error

Area Specification 0.0 to 5.0%

Time Specification 1 to 60 frames

3. SPECIFICATIONS

SDI Analysis Features

Event Log Display

Function	Records detected errors, events—such as the instrument switching between input signals, and timestamps.
Log Capacity	Up to 1000 events
Operation	Logs all events from start to finish
Data Output	Overwrite mode, Stop after 1,000 events

Data Dump Display

Display Format Displays serial data sequence or displays each color component separately

SD, HD, 3G-A, 3G-B DS

PICTURE, stream 1, stream 2

3G-B-DL

PICTURE, link A, link B

HD(DL)

PICTURE, link A, link B

3G(DL)-2K

PICTURE, link 1, link 2

3G(DL)-4K (SER28)

PICTURE, link 1, link 2

3G(QL) (SER28), HD(QL) (SER28)

PICTURE, link 1, link 2, link 3, link 4

6G (SER28/SER29), 12G (SER28/SER29)

PICTURE, sub1, sub2, sub3, sub4

Display Format Details

PICTURE

Links or streams 1 and 2 are combined and displayed in a picture structure.

Stream 1/2

Displays each stream in a transmission structure

Link A, B, 1, 2, 3, 4

Displays the selected link

Line Select

Displays the selected line

Sample Select

Displays from the selected sample

Jump Feature

Jumps to an EAV or SAV

Data Output

Text output to USB memory

3. SPECIFICATIONS

Phase Difference Display

Function Displays the phase difference between a reference signal and an SDI signal numerically and graphically

Reference Signal

SD, HD, 3G-A, 3G-B-DL

External sync signal, Ach

3G-B DS

External sync signal

HD(DL)

External sync signal, Ach, Cch

3G(DL)-2K (SER28)

External sync signal, Ach, Cch

3G(DL)-4K (SER28)

External sync signal, Ach, Cch

HD(QL) (SER28), 3G(QL) (SER28)

External sync signal, Ach

6G (SER28/SER29), 12G (SER28/SER29)

External sync signal

PTP (SER05/SER06) (*1)

RTP, External sync signal (BB), FPT (SER06)

Display Range

Vertical

1 frame

For 3G-B-DL 47.95P to 60P, ± 1 frame measurement possible

Horizontal

± 1 line

* If the reference signal is set to an external sync signal, the measured phase may vary by ± 1 clock depending on the timing when the external sync signal or SDI signal is connected or disconnected or when the power is turned on and off.

*1 Complies only with SMPTE ST 2110.

SDI Ancillary Data List Display

List Display Details Presence or absence of each ancillary data type, embedded line number, and number of packets per frame

Dump Display The selected ancillary data is displayed in hexadecimal or binary.

EDH Display (Only for SD)

Supported Standard SMPTE RP 165

Displayed Contents Analyzes and displays EDH packets and displays received CRC errors

Display Format Text, hexadecimal, binary

Payload ID Display

Supported Standard SMPTE ST 352

Displayed Contents Analyzes and displays payload information

Display Format Text and binary

Displaying Audio Control Packets

Supported Standard SMPTE ST 299-1, SMPTE ST 272

Displayed Contents Displays audio control packet analysis

Display Format Text, hexadecimal, binary

Display Format 1, 2, 3, 4

Japanese Closed Caption Display (*1)

Supported Standard ARIB STD-B37

Displayed Contents Analysis display of closed caption signals

Display Format Text, hexadecimal, binary

3. SPECIFICATIONS

English Closed Caption Display

Supported Video Formats SD, HD, 3G-A, 3G-B-DL,
HD(DL) (close caption decoding only for link A),
3G(DL)-4K (close caption decoding only for link 1),
HD(QL) (close caption decoding only for link 1),
3G(QL) (close caption decoding only for link 1),
6G (close caption decoding only for sub 1),
12G (close caption decoding only for sub 1)

CDP Packet Display Details

CDP packet header information

Presence or absence of timecode packet,
Presence or absence of closed caption packet and validity of
this packet,
Presence or absence of closed caption service packet and
validity of this packet,
Presence or absence of the FUTURE data packet

Time Code When time code packets are present

Closed Caption Data When valid closed caption packets are present

Presence or absence of CC1 to 4, TEXT1 to 4, XDS packets

XDS Packet Display Details

Contents adviser information

Copy management information

Display content of Program Description packet

Stuffing Descriptor

AC3 Audio Descriptor

Caption Service Descriptor

Content Advisory Descriptor

Extended Channel Name Descriptor

Service Location Descriptor

Time-Shifted Service Descriptor

Component Name Descriptor

DCC Arriving Request Descriptor

DCC Arriving Request Descriptor

Redistribution Control Descriptor

Inter-Stationary Control Signal (NET-Q) Display (*1)

ARIB STD-B39

Analysis display of inter-stationary control signals

Text, hexadecimal, binary

Q signal logging

Analysis display of the format ID

Outputs Q signal logs in CSV format through a USB memory
device

Data Broadcast Trigger Signal Display (*1)

ARIB STD-B35

Text, hexadecimal, binary

3. SPECIFICATIONS

V-ANC User Data Display (*1)

ARIB TR-B23
Hexadecimal, binary

AFD Packet Display

SMPTE ST 2016-3
Text, hexadecimal, binary

SCTE-104 Display

Function	SCTE-104 message monitoring
Supported Standard	SMPTE 2010, ANSI/SCTE 104
Supported Format	For Dual / Quad Link, Link1 only (Link cannot be changed)
Supported Input Channel	SDI INPUT 1 / 2 / 3 / 4 (DS1 only)
Display	Superimpose when SCTE-104 message is detected
Display Time	1 to 10 seconds (1 second step)
Log	Records when SCTE-104 message is detected
DUMP Display	Displays DUMP data when SCTE-104 message is detected
SPLICE Display	When a splice_request_data message is detected, the details of the message are displayed
SPLICE Log	Records when a splice_request_data message is detected
SR Live Packet Display	Text, hexadecimal, binary
User-Defined ANC Packet Display	DID, SDID Y, C Hexadecimal, binary

*1 Supported video formats are as follows:

SD, HD, 3G-A, HD(DL) (close caption decoding only for link A),
3G(DL)-4K (close caption decoding only for link 1), HD(QL) (close caption decoding only for link 1),
3G(QL) (close caption decoding only for link 1), 12G (close caption decoding only for sub 1)

Lip Sync Display (SER03)

Displays the phase difference between the video and audio

Lip Sync Measurement

Function	Measures the time difference between the SDI signal and digital audio signal and displays the results numerically and graphically
Reference Signal	A Leader TSG that supports lip syncing (*1)
Measurement Method	Measures the time difference when the luminance level of the video signal exceeds the specified value and when the audio level signal exceeds the specified value
Luminance Level Setting	25 to 100%
Audio Signal Level Setting	-30 to 0 dBFS
Supported Audio Signals	Embedded audio signal, digital audio signal
Measurement Range (Bar Display)	±50 ms, ±100 ms, ±500 ms, ±1.0 s, ±2.5 s
Measurement Range (Numeric Display)	±3999 ms
Measurement Resolution	1 ms

*1 TSG patterns not made by Leader may be supportable by specifying the video signal setting and audio signal setting.

3. SPECIFICATIONS

IP Analysis Function (SER05/SER06)

IP Status Display

Function

SER05 Display the 10G Ethernet (IP 1/2) traffic and streams

SER06 Display the 10G and 25G Ethernet (IP 1/2) traffic and streams

Status Display

Linkup Detects Ethernet linkup

Protocol ST2022-6, ST2110-20/30/40, PTP, UDP

Bit Rate Display Displays the bit rate (Mbps) of the user data section of each stream excluding the header section

Number of Measured Streams

Up to 32

Integration Rate Display Displays the total number of bits per second (Gbps) excluding the Ethernet frame header and FCS

Measurement Range 2 min, 10 min, 30 min, 1 h, 2 h, 6 h, 12 h, 24 h, 72 h

Resolution 1 s

IP Packet Jitter Display

Function

Measures packet arrival intervals of the IP stream and graphically displays fluctuations over time

Measurement Range 2 min, 10 min, 30 min, 1 h, 2 h, 6 h, 12 h, 24 h, 72 h

Resolution 1 s

Display Mode Video Active, Video All, Audio, ANC

PTP Status Display

Function

Displays the PTP time, delay, and grandmaster clock information

Measurement Range 2 min, 10 min, 30 min, 1 h, 2 h, 6 h, 12 h, 24 h, 72 h

Resolution 1 s

Display Mode Delay Time, Time Offset, PTP Info

PTP-RTP Timing Comparison Display

Function

Displays the phase difference between the PTP and ST2110-20 timestamps

Measurement Range 2 min, 10 min, 30 min, 1 h, 2 h, 6 h, 12 h, 24 h, 72 h

Resolution 1 s

Display Mode Video, Audio, ANC, turns on and off separately

One of them is on

Path Delay Display

Function

Displays the stream delay of each input port compalied with SMPTE ST 2022-7

Measurement Range 2 min, 10 min, 30 min, 1 h, 2 h, 6 h, 12 h, 24 h, 72 h

Resolution 1 s

3. SPECIFICATIONS

SFP Module Display

Function Displays information about the installed SFP transceiver module

Packet Header Display

Function Displays information on the selected packet header
Display Mode MAC/IP, UDP/IP, PAYLOAD

Buffer Display (When SER06 is installed and ST2110 is selected as the IP signal standard.)

Function Displays the measured values of Cinst, VRX, or FPT when the transmission type of ST2110-21 is Narrow, Narrow Linear, or Wide
Measurement Range 2 min, 10 min, 30 min, 1 h, 2 h, 6 h, 12 h, 24 h, 72 h
Resolution 1 s
Display Mode CINST, VRX, FPT

NMOS Status Display

Function Displays the CONNECTION and REGISTRATION informations of NMOS. (*1)
Display Mode CONNECTION / REGISTRATION
Number of REGISTRATION Displays 32
DNS-SD Multicast / Unicast / Manual

*1 The informations are cleared when the power is turned on and off.

JPEG XS Packet Header Analysis Display (SER33)

Function Analyze and display JPEG XS packet header information and Box information
Display Mode VIDEO SUPPORT / PROFILE / BUFFER / METADATA / TRANSPORT / IMAGE / COLOR

Display Content

Transmission mode (T) Transmission mode
Packetization mode (K) Packetization mode
Last packet (L) Last packet of frame
Interlaced (I) Frame scan
Frame counter Frame counter
Slice counter Slice counter
Packet counter Packet counter
Video Information box
Bit Rate Maximum bitrate of video stream
Frame Rate Frames per second
Sample Struct Pixel configuration
Timecode Timecode
Profile and Level box
Profile Codestream profile
Level Codestream level
Color Specification box
Color Space Type Color space

3. SPECIFICATIONS

JPEG XS Status Display (SER33)

Error Detection	Detect out-of-order or missing JPEG XS packet errors
Format Display	Detects and displays format information from JPEG XS stream data
RTP Timestamp	Displays the maximum and minimum values of RTP timestamp per field or frame
Packet Count	Displays the maximum and minimum number of packets per field or frame
Payload Data	Displays the maximum and minimum amount of payload data per field or frame

JPEG XS Format Comparison Display (SER33)

Function	Comparative display of formats detected by SDP, ST2110-40 (PID), ST2110-22 (JPEG XS)
Supported Standard	SDP, SMPTE ST 2110-40 (PID), SMPTE ST2110-22 (JPEG XS)

IP Event Log Display

Function	Displays logs according to the event information of each input port
Number of Events	1,000

3.3.35 Eye Pattern (SER02/SER02A)

SDI Input Connector	SDI INPUT 1
Display	Displays the input SDI waveform before equalizing
Number of Displays	
1-Screen Display	Displays the eye pattern of the selected filter in a single screen
2-Screen Display	Displays the timing filter and eye pattern of the selected filter in two screens
Waveform Display Color	7 colors to choose from
Scale Display Color	7 colors to choose from
Method	Equivalent time sampling
Amplitude Accuracy	800 mV \pm 5 % (for 800 mV input)
Time Axis	
2 UI Display	
12G (SER28/SER29)	12.5 ps/div
6G (SER28/SER29)	25ps/div
3G	50 ps/div
HD	100 ps/div
SD	550 ps/div
4 UI Display	
12G (SER28/SER29)	25 ps/div
6G (SER28/SER29)	50ps/div
3G	100 ps/div
HD	200 ps/div
SD	1100 ps/div

3. SPECIFICATIONS

16 UI Display	
12G (SER28/SER29)	100 ps/div
6G (SER28/SER29)	200ps/div
3G	400 ps/div
HD	800 ps/div
SD	4400 ps/div
Time Axis Accuracy	±3 %
Jitter Filter	
10Hz	HPF 10Hz
100Hz	HPF 100Hz
1 kHz	HPF 1 kHz
100 kHz	HPF 100 kHz
TIMING	HPF 10Hz
ALIGNMENT	
12G (SER28/SER29), 6G (SER28/SER29)	HPF 100 kHz
3G, HD	HPF 100 kHz
SD	HPF 1 kHz
Cursor Measurement	Amplitude measurement using Y cursors Time measurement using X cursors Rise time and fall time measurement using the TrTf cursor
Automatic Measurement Items	Eye pattern's amplitude Rise time (the time for the signal to rise from 20 to 80 % of its amplitude) Fall time (the time for the signal to fall from 80 to 20 % of its amplitude) Timing jitter Jitter Rising edge overshoot Falling edge overshoot
Histogram Display	Displays the frequency distribution of the eye pattern waveform amplitudes

3.3.36 Jitter Display (SER02/SER02A)

SDI Input Connector	SDI INPUT 1
Display	Displays the jitter component of an SDI signal
Number of Displays	
1-Screen Display	Displays the jitter waveform of the selected filter in a single screen
2-Screen Display	Displays the timing jitter and the jitter waveform of the selected filter in two screens
Waveform Display Color	7 colors to choose from
Scale Display Color	7 colors to choose from
Method	Phase detection method
Gain	×16, ×8, ×4, ×2, ×1

3. SPECIFICATIONS

Measurement Range	
12G (SER28/SER29)	
×16	0.00 to 1.20 UI
×4	1.20 to 4.80 UI
×2	4.80 to 9.60 UI
×1	9.60 to 19.20 UI
3G, HD, SD, 6G (SER28/SER29)	
×8	0.00 to 1.20 UI
×2	1.20 to 4.80 UI
×1	4.80 to 9.60 UI
Time Axis	1H, 2H, 1V, 2V (*1)
Time Axis Accuracy	±3 %
Jitter Filter	
10Hz	HPF 10Hz
100Hz	HPF 100Hz
1 kHz	HPF 1 kHz
100 kHz	HPF 100 kHz
TIMING	HPF 10Hz
ALIGNMENT	
12G (SER28/SER29), 6G (SER28/SER29)	HPF 100 kHz
3G, HD	HPF 100 kHz
SD	HPF 1 kHz
Cursor Measurement	Jitter value measurement through the use of cursors
Automatic Measurement Display Feature	Displays the jitter value in seconds (sec) and unit intervals (UI)
Automatic Measurement Items	Timing jitter, alignment jitter, jitter
Accuracy	Input jitter frequency: 1 kHz. Filter setting: 10 Hz, within measurement range
0 UI < automatic measured value ≤ 1 UI	±10 % + 0.07 UI
1 UI < automatic measured value ≤ 7 UI	±10 %

*1 2V display is not possible when the input signal is progressive except for 60/59.94/50P of HD(DL).

3.3.37 Tally Display

Number of Displays	3 (TALLY-1, TALLY-2, TALLY-EXT) (*1)
Display Colors	7 colors to choose from
Control Method	Remote connector, RS-422/485 connector (SER27)

*1 The number of displays per channel. Arranged using the customized layout feature or the enhanced layout feature.

3. SPECIFICATIONS

3.3.38 Camera ID Display

Number of Displays	2 (LABEL-1, LABEL-2) (*1)
Iris Display	1 (IRIS) (*1)
Control Method	Instrument, RS-422/485 connector (SER27)

*1 The number of displays per channel. Arranged using the customized layout feature or the enhanced layout feature.

3.3.39 General Specifications

Environmental Conditions

Operating Temperature	0 to 40 °C
Operating Humidity Range	85 %RH or less (no condensation)
Optimal Temperature	10 to 30 °C
Operating Environment	Indoors
Elevation	Up to 2,000 m
Overvoltage Category	II
Pollution Degree	2

Power Requirements

Voltage	90 to 250 VAC
Frequency	50/60Hz
Power Consumption	160 W max.

Dimensions

LV5600	215 (W) × 132 (H) × 298 (D) mm (excluding protrusions)
LV7600	426 (W) × 44 (H) × 300 (D) mm (excluding protrusions)

Weight

LV5600	4.6 kg max. (including options, excluding accessories)
LV7600	4.2 kg max. (including options, excluding accessories)

Accessories

LV5600, LV7600	Power cord 1
	Cover / Inlet stopper 1
	Instruction manual (CD-ROM) 1
LV5600-SER06, LV7600-SER06	IP 1/2 / SFP conversion adapter..... 2

4. PANEL DESCRIPTION

4.1 Front Panel

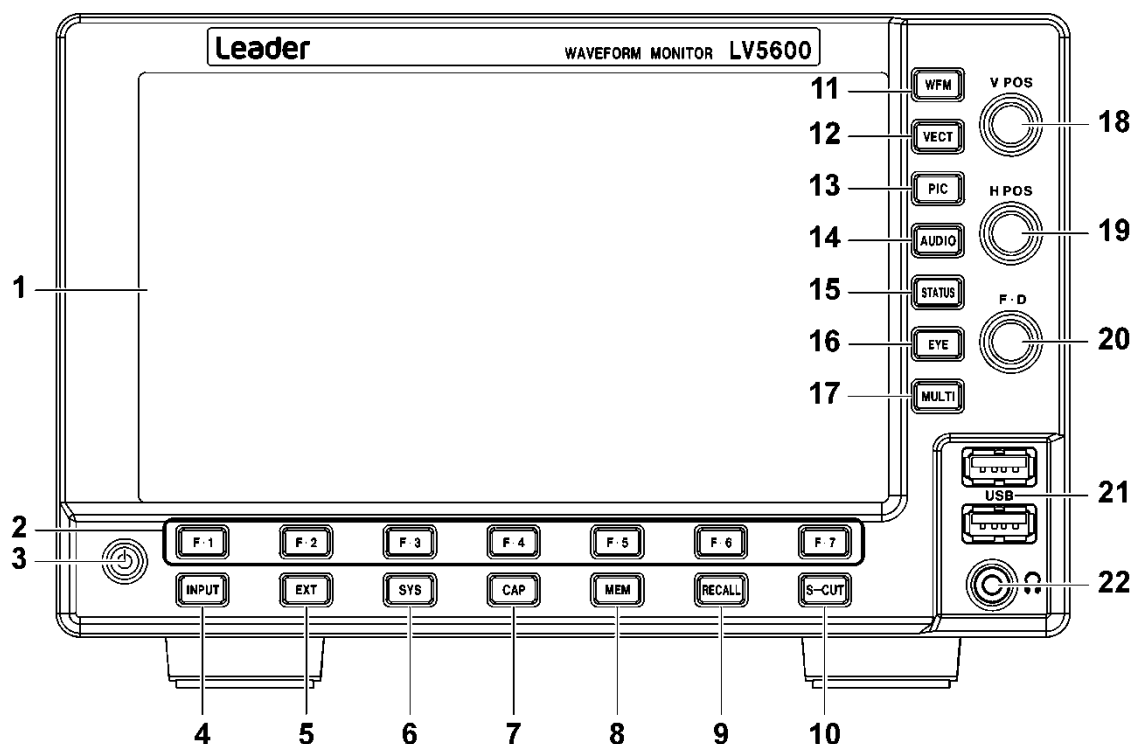

Figure 4-1 LV5600 front panel

Table 4-1 LV5600 front panel description

No.	Name	Description
1	LCD	Displays measurement and setup screens. Control the instrument with the touch panel.
2	F•1 to F•7	Carries out the corresponding function menu operation. [See also] 5.8.2, "Function Menu Operations"
3	Power Switch	Press to turn the instrument on. Hold down to turn the instrument off. [See also] 5.3, "Turning the Instrument On and Off"
4	INPUT	Sets the display channel. [See also] 6.1, "Setting the Input Signals"
5	EXT	Switches the sync signal. When the internal sync signal is being used, this key's LED turns off. When the external sync signal is being used, this key's LED lights. [See also] 5.7.2, "External Sync Signal Input"
6	SYS	Configures the settings [See also] 7, "SYSTEM SETTINGS."
7	CAP	Captures the screen [See also] 8, "CAPTURE FEATURE"
8	MEM	Press this key to register or delete a single preset setting, or copy all preset settings. [See also] 9, "PRESET FEATURE"
9	RECALL	Press this key to recall a preset setting configuration. [See also] 9, "PRESET FEATURE"

4. PANEL DESCRIPTION

No.	Name	Description
10	S-CUT	Loads panel settings, saves a screen capture to the USB memory device, adjusts the intensity, performs cursor measurement, or adjusts the headphone volume. [See also] 6.4, "Operation Key Actions"
11	WFM	Shows the video signal waveform display. You can change the layout as you like. [See also] 10, "Video Signal Waveform Display"
12	VECT	Shows vectors. You can change the layout as you like. [See also] 11, "VECTOR DISPLAY"
13	PIC	Shows the picture display. You can change the layout as you like. [See also] 13, "PICTURE DISPLAY"
14	AUDIO	Shows the audio display. You can change the layout as you like. [See also] 15, "AUDIO DISPLAY"
15	STATUS	Shows the status. You can change the layout as you like. [See also] 16, "Status Display"
16	EYE (SER02/SER02A)	The eye pattern is displayed. You can change the layout as you like. [See also] 17, "EYE PATTERN DISPLAY (SER02/SER02A)"
17	MULTI	Shows a combination of measurement screens. You can change the layout as you like. [See also] 6.3.7, "MULTI-SCREEN DISPLAY"
18	V POS	Turn to adjust the vertical position of the video signal waveform or other item. Press to return to the reference position.
19	H POS	Turn to adjust the horizontal position of the video signal waveform or other item. Press to return to the reference position.
20	F•D	Turn to specify a numeric value or to move cursors. In most cases, press to reset the value to its default value.
21	USB	Connect a USB memory device, USB mouse, or touch panel monitor. [See also] 5.4, "Connecting USB Devices."
22	Headphone jack	This is a mini-plug headphone jack. When a pair of headphones are connected to this jack, the instrument transmits the audio signal embedded in the SDI signal or the audio signal (SER03) received through its rear panel.

4. PANEL DESCRIPTION

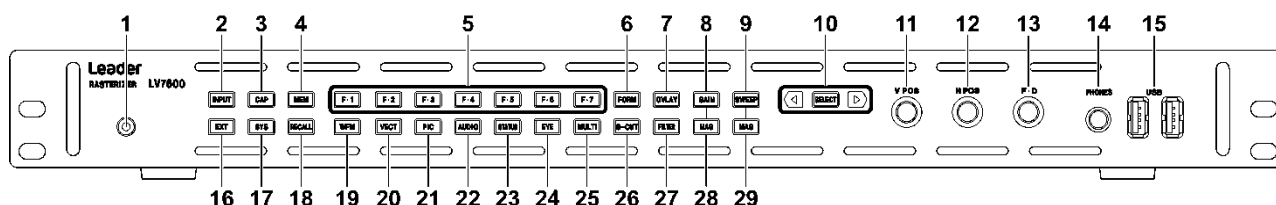

Figure 4-2 LV7600 front panel

Table 4-2 LV7600 front panel description

No.	Name	Description
1	Power Switch	Press to turn the instrument on. Hold down to turn the instrument off. [See also] 5.3, "Turning the Instrument On and Off"
2	INPUT	Sets the display channel. [See also] 6.1, "Setting the Input Signals"
3	CAP	Captures the screen [See also] 8, "CAPTURE FEATURE"
4	MEM	Press this key to register or delete a single preset setting, or copy all preset settings. [See also] 9, "PRESET FEATURE"
5	F•1 to F•7	Carries out the corresponding function menu operation. [See also] 5.8.2, "Function Menu Operations"
6	FORM	Switches the video signal waveform and vector display format. The display format types and order can be changed as you like. [See also] 6.4, "Operation Key Actions"
7	OVLAY	Switches the video signal waveform display format. When the overlay display (video signal waveforms are displayed on top of each other) is in use, this key's LED lights. When the parade display (video signal waveforms are displayed side by side) is in use, this key's LED turns off. [See also] 6.4, "Operation Key Actions"
8	GAIN	Switches the video signal waveform and vector gain. When fixed gain is being used, this key's LED turns off. When variable gain is being used, this key's LED lights. [See also] 6.4, "Operation Key Actions"
9	SWEEP	Switches the video signal waveform sweep method. When line display is being used, this key's LED turns off. When field/frame display is being used, this key's LED lights. The sweep method types and order can be changed as you like. [See also] 6.4, "Operation Key Actions"
10	◀ SELECT ▶	Carries out the corresponding function menu operation. [See also] 5.8.2, "Function Menu Operations"
11	V POS	Turn to adjust the vertical position of the video signal waveform or other item. Press to return to the reference position.
12	H POS	Turn to adjust the horizontal position of the video signal waveform or other item. Press to return to the reference position.
13	F•D	Turn to specify a numeric value or to move cursors. In most cases, press to reset the value to its default value.
14	PHONES	This is a mini-plug headphone jack. When a pair of headphones are

4. PANEL DESCRIPTION

No.	Name	Description
		connected to this jack, the instrument transmits the audio signal embedded in the SDI signal or the audio signal (SER03) received through its rear panel.
15	USB	Connect a USB memory device, USB mouse, or touch panel monitor. [See also] 5.4, "Connecting USB Devices."
16	EXT	Switches the sync signal. When the internal sync signal is being used, this key's LED turns off. When the external sync signal is being used, this key's LED lights. [See also] 5.7.2, "External Sync Signal Input"
17	SYS	Configures the settings [See also] 7, "SYSTEM SETTINGS."
18	RECALL	Press this key to recall a preset setting configuration. [See also] 9, "PRESET FEATURE"
19	WFM	Shows the video signal waveform display. You can change the layout as you like. [See also] 10, "Video Signal Waveform Display."
20	VECT	Shows vectors. You can change the layout as you like. [See also] 11, "VECTOR DISPLAY"
21	PIC	Shows the picture display. You can change the layout as you like. [See also] 13, "PICTURE DISPLAY"
22	AUDIO	Shows the audio display. You can change the layout as you like. [See also] 15, "AUDIO DISPLAY"
23	STATUS	Shows the status. You can change the layout as you like. [See also] 16, "Status Display"
24	EYE (SER02/SER02A)	The eye pattern is displayed. You can change the layout as you like. [See also] 17, "EYE PATTERN DISPLAY (SER02/SER02A)"
25	MULTI	Shows a combination of measurement screens. You can change the layout as you like. [See also] 6.3.7, "MULTI-SCREEN DISPLAY"
26	S-CUT	Loads panel settings, saves a screen capture to the USB memory device, adjusts the intensity, performs cursor measurement, or adjusts the headphone volume. [See also] 6.4, "Operation Key Actions"
27	FILTER	Switches the video signal waveform filter. When FLAT is being used, this key's LED turns off. Otherwise, this key's LED lights. During pseudo-composite display, the filter types and order can be changed as you like. [See also] 6.4, "Operation Key Actions"
28	MAG (GAIN)	Switches the video signal waveform and vector gain. When X1 is being used, this key's LED turns off. Otherwise, this key's LED lights. The vector gain types and order can be changed as you like. [See also] 6.4, "Operation Key Actions"
29	MAG (SWEEP)	Switches the video signal waveform horizontal magnification. When X1 is being used, this key's LED turns off. Otherwise, this key's LED lights. The magnification types and order can be changed as you like. [See also] 6.4, "Operation Key Actions"

4. PANEL DESCRIPTION

4.2 Rear Panel

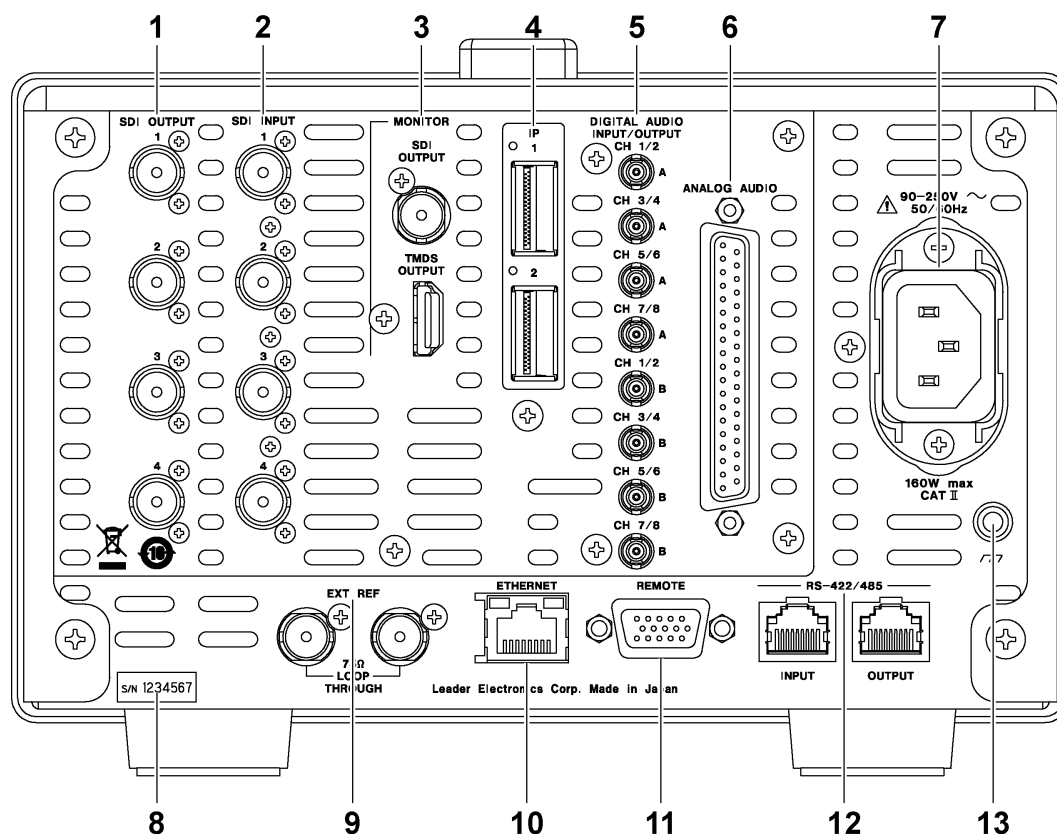

Figure 4-3 LV5600 rear panel (SER01/SER02/SER02A/SER03/SER05/SER06)

Table 4-3 LV5600 rear panel description

No.	Name	Description
1	SDI OUTPUT (SER01/SER02/SER02A)	SDI signal output connectors [See also] 5.7.1, "SDI Signal I/O."
2	SDI INPUT (SER01/SER02/SER02A)	SDI signal input connectors. [See also] 5.7.1, "SDI Signal I/O."
3	MONITOR	Transmits the screen image. [See also] 5.7.6, "Monitor Signal Output"
4	IP (SER05/SER06)	IP signal input/output connectors. The SER05 is used by attaching the separately sold SFP+ module to the SFP+ connector. The SER06 is used by attaching the included conversion adapter to the IP I/O connector and then attaching the separately sold SFP+ or SFP28 module. [See also] 5.5, "Installing the SFP+ Module (SER05)" and 5.6, "Installing the SFP+/SFP28 Module (SER06)"
5	DIGITAL AUDIO INPUT/OUTPUT (SER03)	Digital audio signal I/O connectors. Switch between input and output using audio menu. [See also] 5.7.4, "Digital Audio I/O (SER03)."
6	ANALOG AUDIO (SER03)	Analog audio signal I/O connectors. Switch between input and output using audio menu. [See also] 5.7.5, "Analog Audio Signal I/O (SER03)"

4. PANEL DESCRIPTION

No.	Name	Description
7	AC inlet	An inlet for receiving AC power. Attach the included cover/inlet stopper to the AC inlet. [See also] 5.1, "Attaching the Cover Inlet Stopper"
8	Serial number label	The serial number is printed on this label.
9	EXT REF	External reference input connector. This is a loop-through connector. [See also] 5.7.2, "External Sync Signal Input"
10	ETHERNET	Ethernet port. Supports TELNET, FTP, SNMP, HTTP, and SNTP.
11	REMOTE	15-pin D-sub remote connector. This can be used to execute actions such as recalling preset settings.
12	RS-422/485 (SER27)	Receives tally, camera ID, and camera iris signals through serial communication and displays them.
13	Ground terminal	Connect the instrument to an external ground.

4. PANEL DESCRIPTION

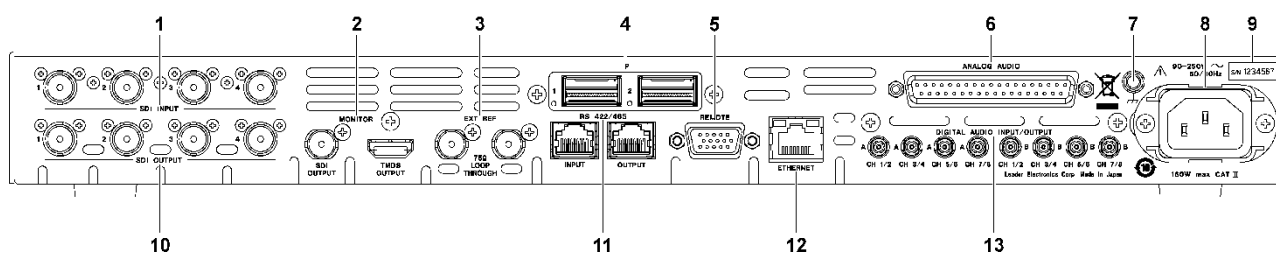

Figure 4-4 LV7600 rear panel (SER01/SER02/SER02A/SER03/SER05/SER06)

Table 4-4 LV7600 rear panel description

No.	Name	Description
1	SDI INPUT (SER01/SER02/SER02A)	SDI signal input connectors. [See also] 5.7.1, "SDI Signal I/O."
2	MONITOR	Transmits the screen image. [See also] 5.7.6, "Monitor Signal Output"
3	EXT REF	External reference input connector. This is a loop-through connector. [See also] 5.7.2, "External Sync Signal Input"
4	IP (SER05/SER06)	IP signal input/output connectors. The SER05 is used by attaching the separately sold SFP+ module to the SFP+ connector. The SER06 is used by attaching the included conversion adapter to the IP I/O connector and then attaching the separately sold SFP+ or SFP28 module. [See also] 5.5, "Installing the SFP+ Module (SER05)" and 5.6, "Installing the SFP+/SFP28 Module (SER06)"
5	REMOTE	15-pin D-sub remote connector. This can be used to execute actions such as recalling preset settings.
6	ANALOG AUDIO (SER03)	Analog audio signal I/O connectors. Switch between input and output using audio menu. [See also] 5.7.5, "Analog Audio Signal I/O (SER03)"
7	Ground terminal	Connect the instrument to an external ground.
8	AC inlet	An inlet for receiving AC power. Attach the included cover/inlet stopper to the AC inlet. [See also] 5.1, "Attaching the Cover Inlet Stopper"
9	Serial number label	The serial number is printed on this label.
10	SDI OUTPUT (SER01/SER02/SER02A)	SDI signal output connectors [See also] 5.7.1, "SDI Signal I/O."
11	RS-422/485 (SER27)	Receives tally, camera ID, and camera iris signals through serial communication and displays them.
12	ETHERNET	Ethernet port. Supports TELNET, FTP, SNMP, HTTP, and SNTP.
13	DIGITAL AUDIO INPUT/OUTPUT (SER03)	Digital audio signal I/O connectors. Switch between input and output using audio menu. [See also] 5.7.4, "Digital Audio I/O (SER03)."

5. BEFORE YOU BEGIN MEASURING

5.1 Precautions When Installing the ZEN series

The ZEN series WAVEFORM MONITORS have intake and exhaust ports for ventilation. The intake ports and exhaust ports of each model are shown below.

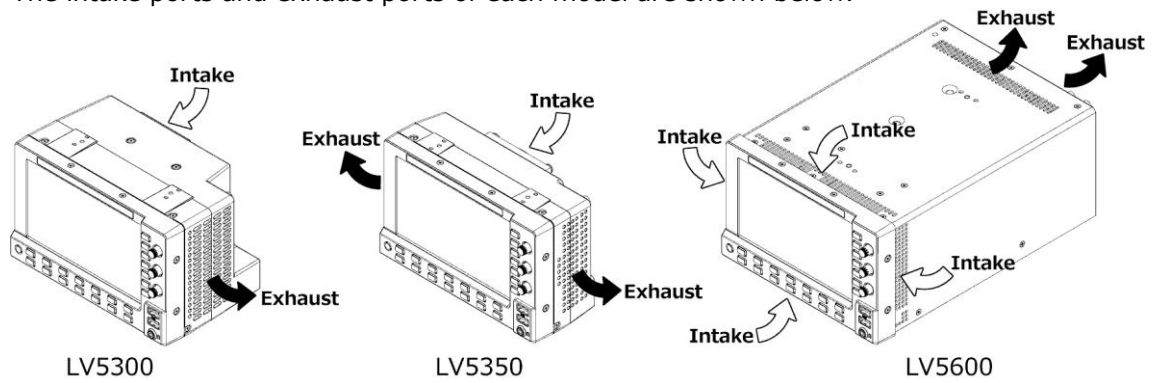

Taking precautions the following when installing the ZEN series.

- When installing, don't block the ventilation ports.
- If there is a wall near the ventilation port, make a ventilation hole on the wall.

5. BEFORE YOU BEGIN MEASURING

- When installing the ZEN series instruments side by side, make sure that the intake and exhaust ports are not next to each other.
- When installing the LV5300 and the LV5350 or LV5600 side by side, place the LV5300 on the right side when viewed from the front panel side.

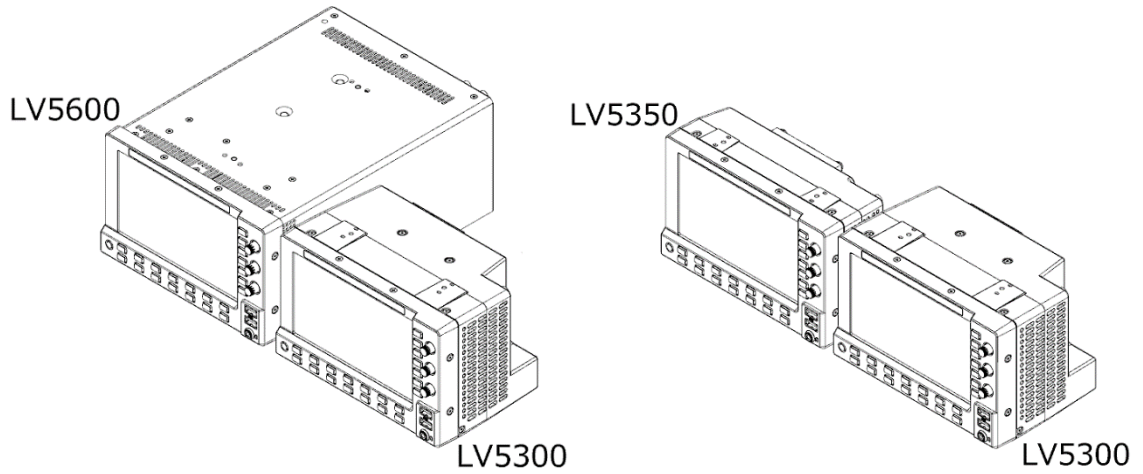

- When installing the LV5350 and LV5600 side by side, place the LV5350 on the right side when viewed from the front panel side, and separate the LV5350 and LV5600 by a partition.

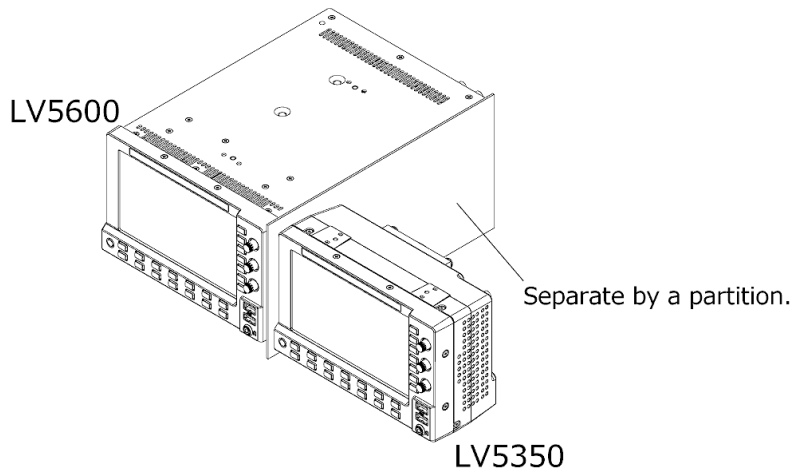

- When installing two ZEN series instruments side by side, install them at the following intervals.

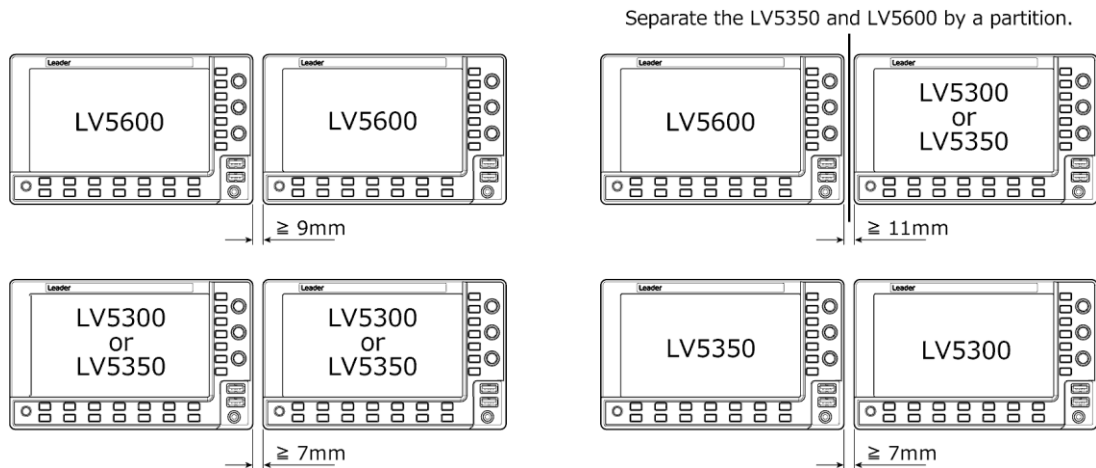

5.2 Attaching the Cover Inlet Stopper

A cover/inlet stopper is included with the instrument. Use this device to prevent the power cord from being pulled free of the AC inlet. To attach the cover/inlet stopper, follow the procedure below.

- Installation

1. Cover the power cord with the cover/inlet stopper.

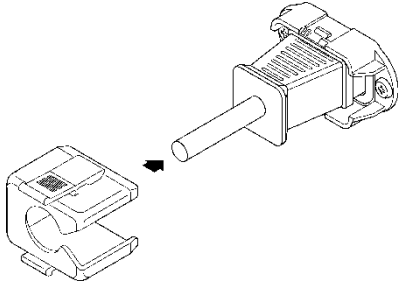

2. Push the cover/inlet stopper, until you hear a click, to attach it to the AC inlet.

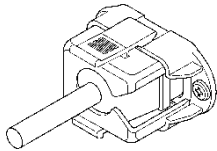

3. Check that the cover/inlet stopper is securely attached to the AC inlet.

- Removing the Cover/Inlet Stopper

1. Release the lock by using two fingers to press the cover/inlet stopper levers.

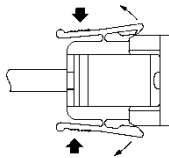

2. Pull the cover/inlet stopper away from the AC inlet.

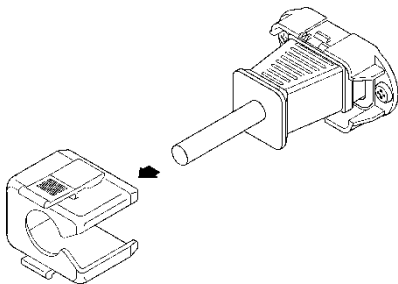

5.3 Turning the Instrument On and Off

To turn on the power, press the power switch. The power switch LED lights, and the instrument turns ON. When you turn ON the power, the instrument starts up with the same panel settings that were set when it was last turned OFF.

To turn off the power, hold down the power switch for at least 2 seconds. The power switch LED and the instrument turn OFF.

5.4 Connecting USB Devices

The front panel has two USB ports. You can connect a USB memory device, USB mouse, or touch panel monitor to these ports. You can connect the devices to either USB port, but you cannot connect the same type of devices to the instrument simultaneously.

USB devices can be connected or removed with the power turned on.

- USB Memory Device

When a USB memory device is connected, a USB memory icon  appears in the upper right of the screen.

You can save various types of data in a USB memory device.

This icon is normally green, but it changes to red when the USB memory device is being accessed. Do not turn the power OFF or remove the USB memory device when the icon is red.

- USB Mouse

When a USB mouse is connected, a mouse icon  appears in the upper right of the screen. Basic operations can be performed without a mouse, but arranging the measurement screen layout requires a mouse or touch panel control.

[See also] 6.5, "Customized Layout (SER26)," 6.6, "Enhanced Layout (SER26)"

- Touch Panel Monitor

When the USB touch panel interface of a touch panel monitor is connected, a mouse icon  appears in the upper right of the screen. The video interface of the touch panel monitor is connected to the monitor output connector.

Basic operations can be performed without a touch panel, but arranging the measurement screen layout requires a mouse or touch panel control.

[See also] 6.5, "Customized Layout (SER26)," 6.6, "Enhanced Layout (SER26)"

5.5 Installing the SFP+ Transceiver Module (SER05)

If the SER05 is installed, the rear panel has two IP input connectors. Install SFP+ modules sold separately.

You can connect and disconnect an SFP+ transceiver module with the power turned on. To install it, follow the procedure below.

LV5600-SER05

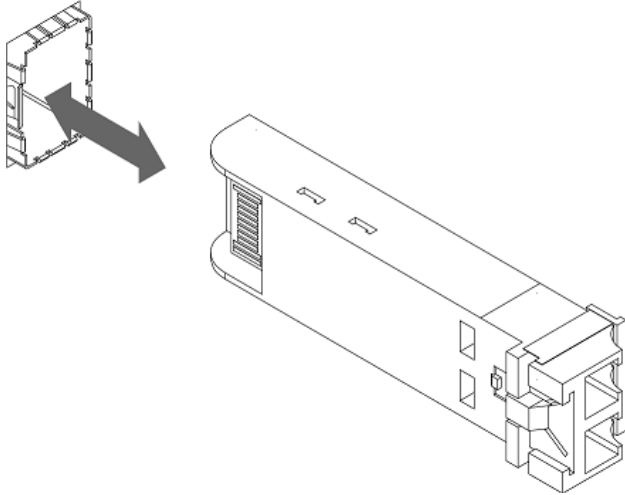

LV7600-SER05

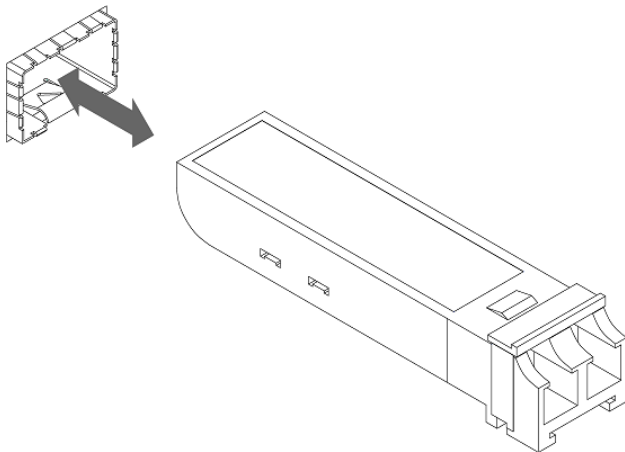

- Installation

1. Pay attention to the orientation of the SFP+ module, and insert the module into IP input connector 1.
2. Push it in until a click is heard.
3. Install another module into 2 in a similar manner.

- Uninstallation

Pinch the SFP+ transceiver module with your fingers, and pull it out. Do not pull the cable.

5.6 Installing the SFP+/SFP28 Transceiver Module (SER06)

If the SER06 is installed, the rear panel has two IP input/output connectors. Attach the conversion adapter supplied with the SER06 and then attach the separately sold SFP+ or SFP28 module.

You can connect and disconnect an SFP transceiver module with the power turned on. To install it, follow the procedure below.

LV5600-SER06

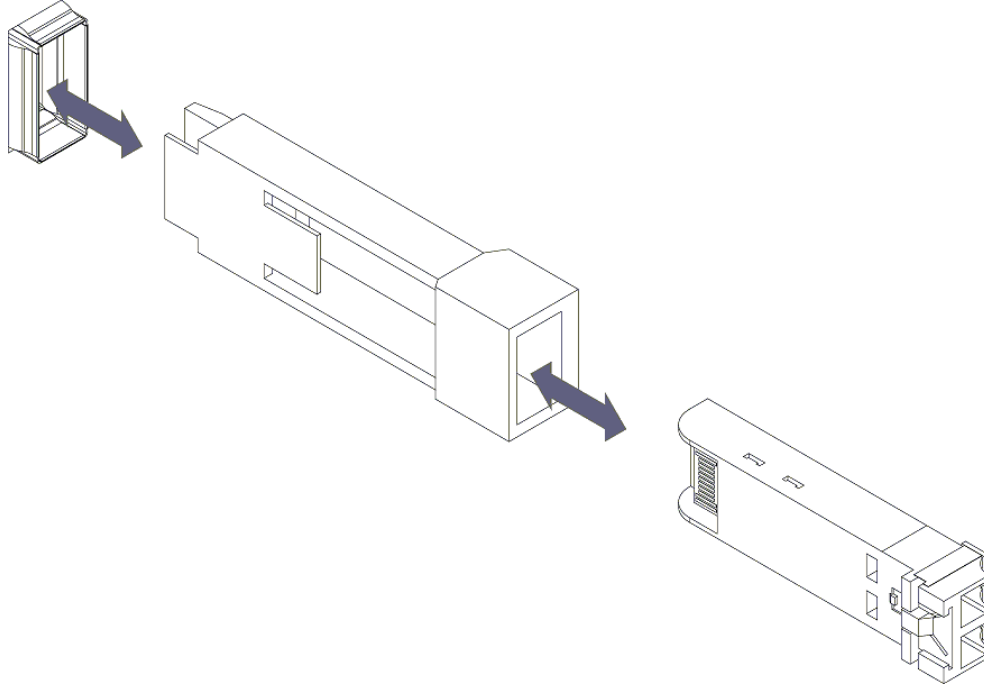

LV7600-SER06

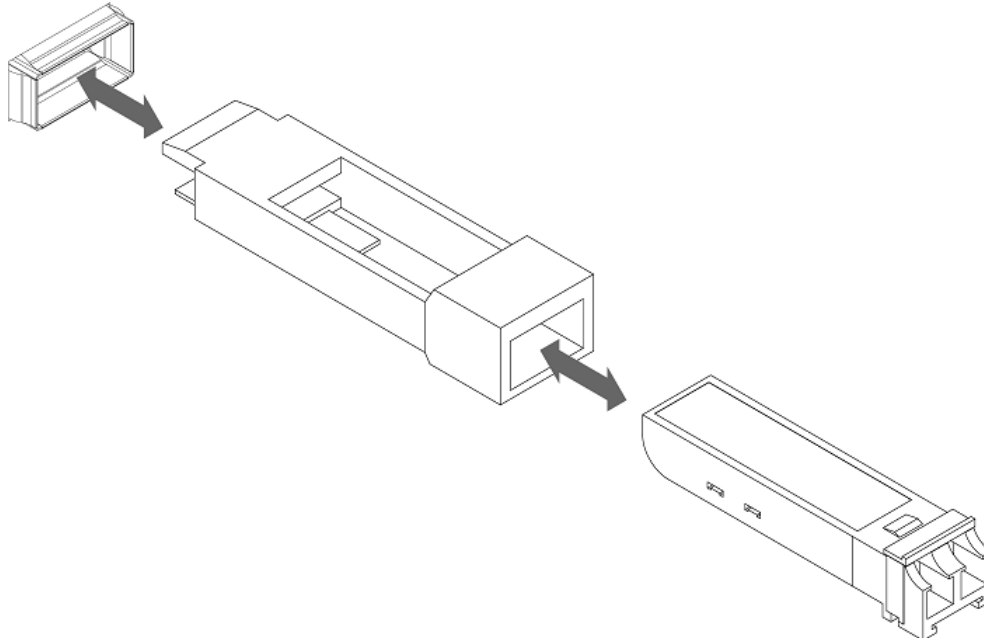

5. BEFORE YOU BEGIN MEASURING

- Attaching the Conversion Adapter
 1. Pay attention to the orientation of the conversion adapter, and insert it into IP I/O connector 1.
 2. Push it in until a click is heard.
 3. Install another module into 2 in a similar manner.
- Attaching the SFP Module
 1. Pay attention to the orientation of the SFP+ or SFP28 module, and insert the module into IP input/output connector 1.
 2. Push it in until a click is heard.
 3. Install another module into 2 in a similar manner.
- Removing the SFP Module

Pinch the SFP+ or SFP28 transceiver module with your fingers, and pull it out. Do not pull the cable.

5.7 Signal I/O

5.7.1 SDI Signal I/O

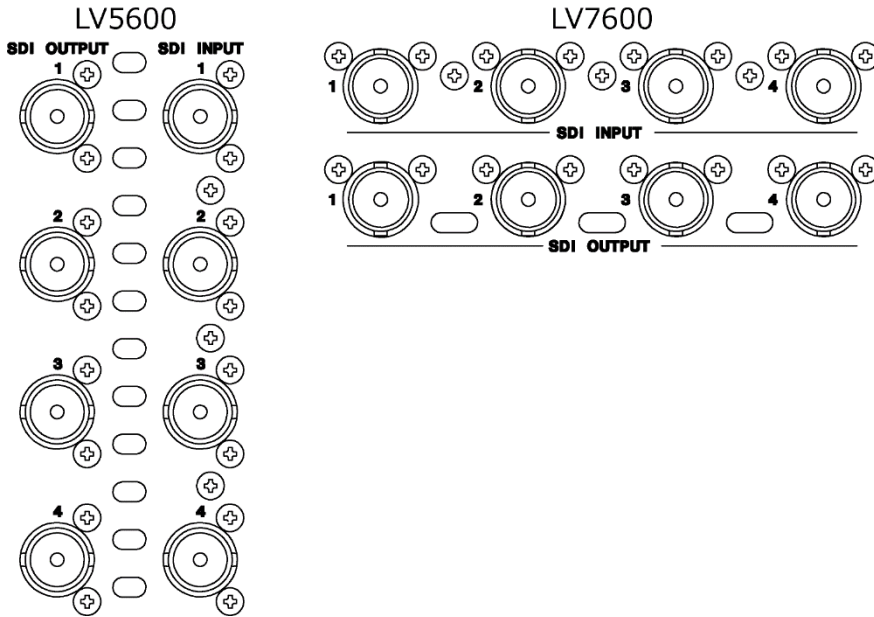

* When an SER01 or SER02/SER02A is installed

Figure 5-1 SDI I/O connectors

- SDI Signal Input SDI INPUT 1 to 4

These are the input connectors for the link system.

Apply signals that are specified in section 3.3.1, "SDI Video Formats and Standards," and section 3.3.2, "SDI Audio Formats and Standards."

Select the SDI System on the SDI IN SETUP1 tab of the SYS menu, and then apply signals to SDI INPUT 1 to 4.

[See also] SDI IN SETUP1 tab → 7.1.1, "Configuring the SDI Input Connectors."

Table 5-1 SDI signal input

Link System	Connector Type
Single link	Apply to SDI INPUT 1, 2, 3, and 4 (up to four inputs)
Dual link	Apply to SDI INPUT 1/2 and 3/4 (up to two inputs)
Quad link	Apply to SDI INPUT 1/2/3/4 (up to one input)

5. BEFORE YOU BEGIN MEASURING

- SDI Signal Output SDI OUTPUT 1 to 4

There are two SDI signal output settings: Input Through and Test Signal. You can set it on the SDI OUT tab of the SYS menu.

- Input Through

SDI OUTPUT 1 to 4 transmit reclocked signals of the signals received through SDI INPUT 1 to 4. Use the signals for monitoring.

For single link, you can select whether to assign SDI OUTPUT 1 to SDI INPUT 1 or a channel that you select on the SDI OUT tab. If you select to use a channel that you select, set the output channel using the INPUT menu or **F•6** INPUT SELECT in the appropriate measurement screen.

If SER26 is installed, you can also output the signal assigned with Display Assignment on the SDI IN SETUP1 tab. For IP, IP signals are converted into SDI signals and output. However, for 4K measurement, 12G-SDI output is not possible.

- Test Signal

SDI OUTPUT 1 to 4 output various patterns. You can superimpose a moving box, vary the phase, and so on. You can use the instrument as a signal generator.

- Terminators

The SDI input connectors are terminated internally at 75 Ω , so there is no need to connect terminators to them. Connect cables with a characteristic impedance of 75 Ω .

- Setting the Display Channels

Configure the display channels using the SDI IN SETUP1 tab of the SYS menu and the INPUT menu.

[See also] 6.2, "Setting the Signals to Measure"

- Cables

It has been confirmed that errors do not occur when the instrument receives an 800 mVp-p stress pattern through the following cables.

Input Signal	Cable Type	Input Connector (SDI INPUT 1 to 4)	Video Pattern
12G	L5.5CUHD cable	70 m	Color bar
3G	LS-5CFB cable	70 m	Check field
HD	LS-5CFB cable	110 m	Check field
SD	L-5C2V cable	200 m	Check field

5.7.2 IP Signal Input/output (SER05/SER06)

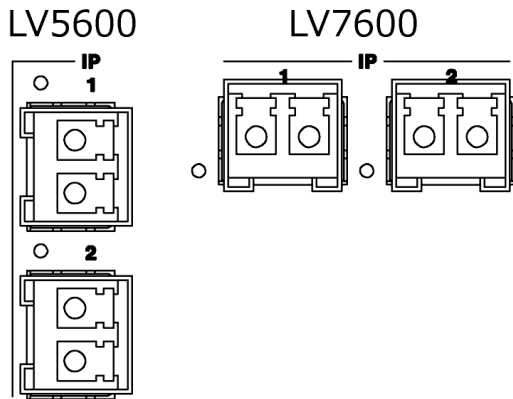

* When SFP+ modules (sold separately) are installed

Figure 5-2 IP input/output connectors (SER05)

For the SER05, attach the separately sold SFP+ module, and then connect the IP signals to IP 1 and 2.

For the SER06, attach the included conversion adapter and the separately sold SFP+ or SFP28 module, and then connect the IP signals to IP 1 and 2.

Because IP 1 and 2 take on a redundant structure, when connecting signals to both connectors, connect the same signal to them. If you are connecting the signal to one of the connectors, connect it to IP 1.

To configure IP settings, use the SDI IN SETUP1, IP SETUP1, IP SETUP2, IP TSG SETUP1, IP TSG SETUP1-2, IP TSG SETUP2, IP TSG SETUP3 and NMOS tabs of the SYS menu.

[See also] SDI IN SETUP1 tab → 7.1.1, "Configuring the Input System," 7.1.2 "Input Signal Assignment"

IP SETUP1 tab → 7.1.10, "Configuring the IP Signal Settings (SER05/SER06)"

IP SETUP2 tab → 7.1.11, "Configuring PTP Settings (SER05/SER06)," 7.1.12, "Setting the Video Format (SER05/SER06)"

IP TSG SETUP1 tab → 7.1.13, "Setting the IP TSG Output (SER32)," 7.1.14, "Setting the IP TSG Signal (SER32)"

IP TSG SETUP1-2 tab → 7.1.15, "Setting the IP TSG Characters (SER32)"

IP TSG SETUP2 tab → 7.1.16, "Setting the IP Parameters of the IP TSG Signal (SER32)"

IP TSG SETUP3 tab → 7.1.17, "Setting the IP TSG Packet Emulation (SER32)"

NMOS tab → 7.1.18, "Configuring the NMOS Settings (SER05/SER06)"

- SDI IN SETUP1 Tab

Set the SDI System to 2K SD/HD/3G-A/3G-B-DL. Then, set Display Assignment Type to IP (when the SER26 is not installed), or assign IP Stream1 to 4 to Input-A to D (when the SER26 is installed). If Type is set to IP, IP Stream1 to 4 are assigned to Input-A to D, respectively.

- IP SETUP1 Tab

Set the signal standard, IP address, and port number. You can set the IP address and port number for each stream.

5. BEFORE YOU BEGIN MEASURING

- IP SETUP2 Tab
Configure the PTP and video format settings.
- IP TSG SETUP1 Tab
Configure the IP TSG output and IP test signal settings.
- IP TSG SETUP1-2 Tab
Configure the character display function for IP TSG output.
- IP TSG SETUP2 Tab
Configure the IP settings of TSG IP.
- IP TSG SETUP3 Tab
Configure IP TSG packet emulation.
- NMOS Tab
Configure NMOS.

5.7.3 External Sync Signal Input

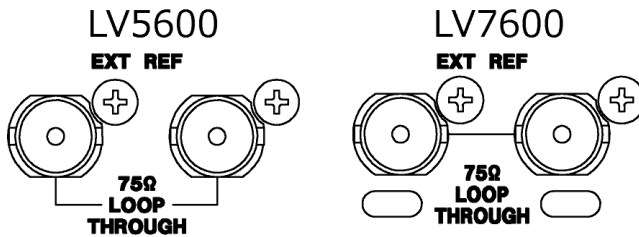

Figure 5-3 External sync signal input connectors

On the video-signal-waveform and vector displays, you can apply an external sync signal to display waveforms. (*1) Apply an external sync signal to an external sync signal input connector, and then press EXT. The instrument determines the sync signal format automatically.

As shown in the figure below, the external sync signal input connectors are loop-through. Apply the input signal to one of the two connectors, and terminate the other connector at 75 Ω , or connect it to another 75 Ω device. If you connect to another device, be sure to terminate the device at the end of the chain at 75 Ω . Connect cables with a characteristic impedance of 75 Ω .

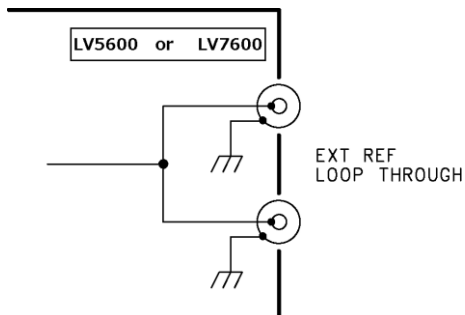

Figure 5-4 Loop-through

- *1 Waveform display using an external sync signal is not possible for the following formats.
- IP input video signal using SER05/SER06
 - 3G's 720/30P, 720/29.97P, 720/25P, 720/24P, 720/23.98P
 - HD(DL)'s 1080/60P, 1080/59.94P, 1080/50P
 - 3G(DL), 3G(QL), HD(QL), 6G, 12G
 - Frame frequency 48P, 47.95P

5. BEFORE YOU BEGIN MEASURING

External sync signals that are compatible with each input signal are indicated with a check mark in the following table.

Proper measurement is possible only for combinations that are indicated with check marks.

Table 5-2 External sync signal formats (SD, HD)

		SDI (SD, HD) Input Signal Format																								
		525/59.94I	625/50I	1080/60I	1080/59.94I	1080/50I	1080/30PsF	1080/29.97PsF	1080/25PsF	1080/24PsF	1080/23.98PsF	1080/30P	1080/29.97P	1080/25P	1080/24P	1080/23.98P	720/60P	720/59.94P	720/50P	720/30P	720/29.97P	720/25P	720/24P	720/23.98P		
External Sync Signal Format	NTSC with 10 field ID (59.94Hz)(*1)	✓			✓			✓		✓		✓			✓			✓			✓				✓	
	NTSC (59.94Hz)	✓			✓			✓				✓						✓			✓					
	PAL (50Hz)		✓			✓		✓					✓						✓			✓				
	1080/60I			✓			✓				✓															
	1080/59.94I				✓			✓				✓														
	1080/50I					✓			✓				✓													
	1080/24PsF									✓					✓											
	1080/23.98PsF										✓					✓										
	1080/30P			✓			✓					✓														
	1080/29.97P				✓			✓					✓													
	1080/25P					✓			✓					✓												
	1080/24P									✓					✓											
	1080/23.98P										✓					✓										
	720/60P																✓									
	720/59.94P																	✓								
	720/50P																		✓							
	720/30P																				✓					
	720/29.97P																					✓				
720/25P																						✓				
720/24P																							✓			
720/23.98P																								✓		

*1 If the input signal is 1080/23.98PsF or 1080/23.98P, the 10 field ID is automatically detected.

5. BEFORE YOU BEGIN MEASURING

Table 5-3 External sync signal formats (3G)

		SDI (3G) Input Signal Format																		
		1080/60P	1080/59.94P	1080/50P	1080/60I	1080/59.94I	1080/50I	1080/30PsF	1080/29.97PsF	1080/25PsF	1080/24PsF	1080/23.98PsF	1080/30P	1080/29.97P	1080/25P	1080/24P	1080/23.98P	720/60P	720/59.94P	720/50P
External Sync Signal Format	NTSC with 10 field ID (59.94Hz)(*1)		✓			✓			✓			✓					✓		✓	
	NTSC (59.94Hz)		✓			✓			✓					✓						✓
	PAL (50Hz)			✓			✓			✓					✓					
	1080/60I	✓			✓			✓												
	1080/59.94I		✓			✓			✓											
	1080/50I			✓			✓			✓										
	1080/24PsF										✓					✓				
	1080/23.98PsF											✓					✓			
	1080/30P	✓			✓			✓					✓							
	1080/29.97P		✓			✓			✓					✓						
	1080/25P			✓			✓			✓					✓					
	1080/24P										✓					✓				
	1080/23.98P											✓					✓			
	720/60P																	✓		
	720/59.94P																		✓	
	720/50P																			✓

*1 If the input signal is 1080/23.98PsF or 1080/23.98P, the 10 field ID is automatically detected.

5. BEFORE YOU BEGIN MEASURING

Table 5-4 External sync signal formats (6G)

		SDI (6G) Sub Image Input Signal Format (*1)				
		1080/30P	1080/29.97P	1080/25P	1080/24P	1080/23.98P
External Sync Signal Format	NTSC with 10 field ID (59.94Hz) (*2)		✓			✓
	NTSC (59.94Hz)		✓			
	PAL (50Hz)			✓		
	1080/30P	✓				
	1080/29.97P		✓			
	1080/25P			✓		
	1080/24P				✓	
	1080/23.98P					✓

*1 If the input signal is 6G, the phase difference is measured for the 4k sub image format.

*2 If the input signal is 1080/23.98PsF or 1080/23.98P, the 10 field ID is automatically detected.

Table 5-5 External sync signal formats (12G)

		SDI (12G) Sub Image Input Signal Format (*1)							
		1080/60P	1080/59.94P	1080/50P	1080/30P	1080/29.97P	1080/25P	1080/24P	1080/23.98P
External Sync Signal Format	NTSC with 10 field ID (59.94Hz) (*2)		✓			✓			✓
	NTSC (59.94Hz)		✓			✓			✓
	PAL (50Hz)			✓			✓		
	1080/60I	✓							
	1080/59.94I		✓			✓			
	1080/50I			✓			✓		
	1080/30P	✓			✓				
	1080/29.97P		✓			✓			
	1080/25P			✓			✓		
	1080/24P							✓	
	1080/23.98P								✓

*1 If the input signal is 12G, the phase difference is measured for the 4k sub image format.

*2 If the input signal is 1080/23.98PsF or 1080/23.98P, the 10 field ID is automatically detected.

5.7.4 Digital Audio I/O (SER03)

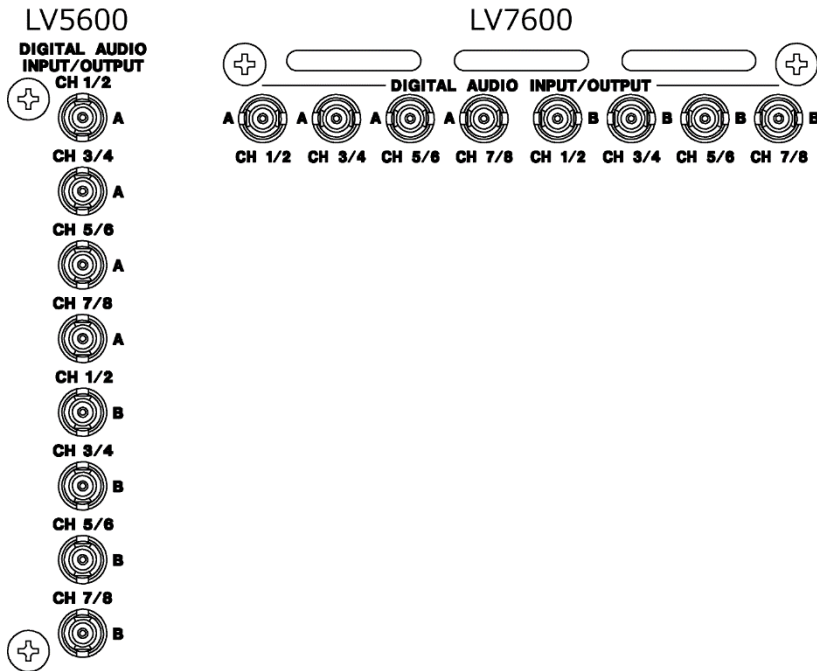

* When an SER03 is installed

Figure 5-5 Digital audio I/O connectors

• Input/Output Switching

The connectors can be switched between input and output in groups (A and B). Under EXTERNAL AUDIO on the AUDIO IN/OUT tab of the AUDIO menu, select Input or Output.

[See also] AUDIO IN/OUT tab → 15.1.5, “Configuring the Audio Input/Output Connectors (SER03)”

• Audio Signal Output

If group A or B is set to output, the following signals are output. Use the signals for monitoring.

Table 5-6 Audio signal output

INPUT	CH Mode	Group A Output	Group B Output
SDI	8ch	8 channels in the 1st GROUP and 2nd GROUP	8 channels in the 1st GROUP and 2nd GROUP
	16ch	8 channels in the 1st GROUP and 2nd GROUP	8 channels in the 3rd GROUP and 4th GROUP
EXT AUDIO	8ch	- (Input)	8 channels applied to group A
		8 channels applied to group B	- (Input)
	16ch	- (Input)	- (Input)

5. BEFORE YOU BEGIN MEASURING

5.7.5 Analog Audio Signal I/O (SER03)

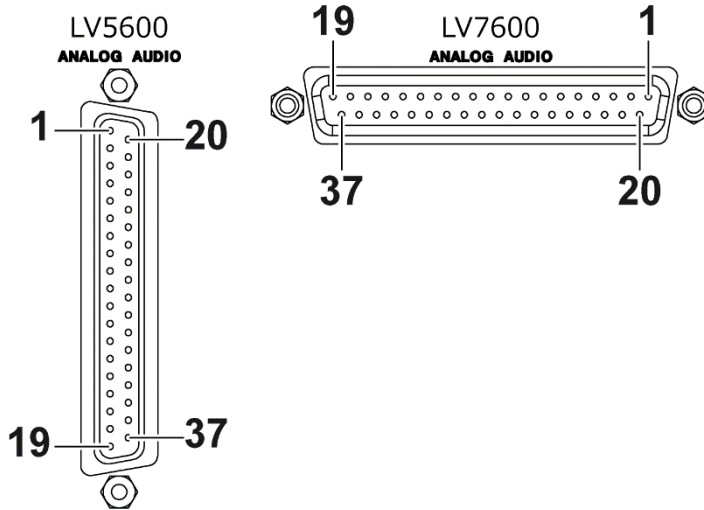

* When an SER03 is installed

Figure 5-6 Analog Audio Signal I/O Connector (female, inch screws)

Table 5-7 Analog audio I/O connector pinout example

Pin No.	Name	Pin No.	Name	I/O	Function
37	INPUT1+	19	INPUT1-	I	Analog audio input 1
36	INPUT2+	18	INPUT2-	I	Analog audio input 2
35	INPUT3+	17	INPUT3-	I	Analog audio input 3
-	-	16	GND	-	Ground
34	INPUT4+	15	INPUT4-	I	Analog audio input 4
33	INPUT5+	14	INPUT5-	I	Analog audio input 5
32	INPUT6+	13	INPUT6-	I	Analog audio input 6
31	GND	-	-	-	Ground
30	INPUT7+	12	INPUT7-	I	Analog audio input 7
29	INPUT8+	11	INPUT8-	I	Analog audio input 8
-	-	10	GND	-	Ground
28	OUTPUT1+	9	OUTPUT1-	O	Analog audio output 1
27	OUTPUT2+	8	OUTPUT2-	O	Analog audio output 2
26	OUTPUT3+	7	OUTPUT3-	O	Analog audio output 3
25	OUTPUT4+	6	OUTPUT4-	O	Analog audio output 4
24	OUTPUT5+	5	OUTPUT5-	O	Analog audio output 5
23	OUTPUT6+	4	OUTPUT6-	O	Analog audio output 6
22	OUTPUT7+	3	OUTPUT7-	O	Analog audio output 7
21	OUTPUT8+	2	OUTPUT8-	O	Analog audio output 8
20	GND	1	GND	-	Ground

5. BEFORE YOU BEGIN MEASURING

- Input/Output Switching

This connector is used by switching between input and output.

Under ANALOG AUDIO on the AUDIO IN/OUT tab of the AUDIO menu, select Input or Output.

[See also] AUDIO IN/OUT tab → 15.1.5, “Configuring the Audio Input/Output Connectors (SER03)”

- Audio Signal Output

8 audio signal channels displayed on the screen are output.

Use the signals for monitoring.

5.7.6 Monitor Signal Output

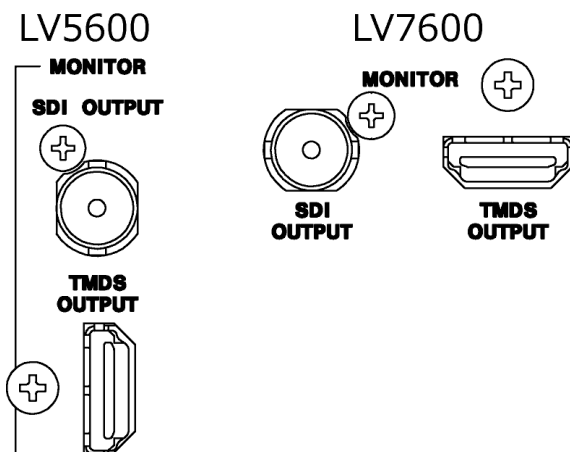

Figure 5-7 Monitor output connectors

The SDI OUTPUT connector and TMDS OUTPUT connector transmit the instrument’s screen for monitoring purposes. Connect to a full high definition (1920×1080) display.

- Selecting the Sync Mode

On the MONITOR OUT tab of the SYS menu, select internal synchronization or external synchronization. If you select internal synchronization, you can also select the output format.

[See also] MONITOR OUT tab → 7.1.8, “Configuring the Monitor Output Connectors”

5.8 Operation Basics

5.8.1 Displaying the Function Menu

Use the function menu to change the various settings.

Normally the function menu is displayed, but it can be cleared by pressing the mode key that is currently selected. You can also set it to disappear automatically on the GENERAL tab of the SYS menu.

[See also] GENERAL tab → 7.2.1, “General Settings”

If the measurement menu disappears, carry out one of the following operations to display it again. When you perform this operation, the menu is displayed at the level that was displayed before it disappeared.

- Displaying the Menu by Pressing the Mode Key

Press the currently selected mode key (WFM, VECT, PIC, AUDIO, STATUS, or EYE) to display the menu again.

In multi-screen display, you can select whether to switch the measurement screen with the mode keys (WFM, VECT, PIC, AUDIO, STATUS, and EYE) on the GENERAL tab of the SYS menu.

[See also] GENERAL tab → 7.2.1, “General Settings”

- Pressing a Function Key to Display a Menu

Press one of the function keys to display the menu again.

5.8.2 Function Menu Operations

This section explains how to operate the function menu, using the **WFM** → **F•1** WFM INTEN/CONFIG menu as an example.

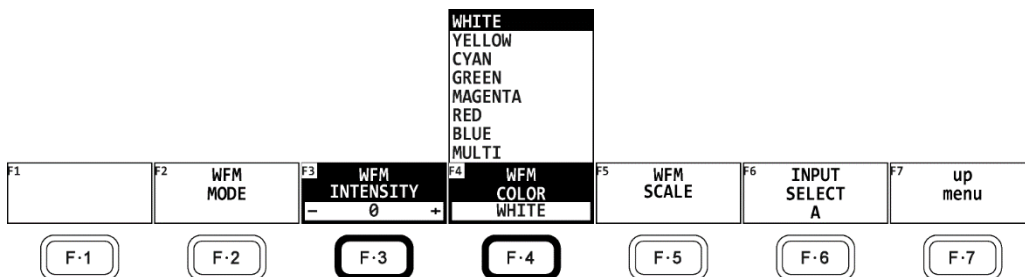

Figure 5-8 Function menu operations

- Specifying Values

To set the value of a setting like **F•3** WFM INTENSITY, which is shown in the figure above, press **F•3**, and then turn the function dial (F•D). You can reset most settings to their default values by pressing the function dial (F•D).

5. BEFORE YOU BEGIN MEASURING

- Selecting Settings

To select a setting from a list like the one shown in the figure above for **F•4** WFM COLOR, press **F•4** several times to select the setting you want. The setting changes each time you press **F•4**. After you stop pressing **F•4**, the setting is confirmed and the pop-up menu disappears.

When the options are on and off or start and stop, the setting toggles each time you press the key.

- Selecting Settings Using the ◀ SELECT ▶ Key (LV7600)

On the LV7600, you can use the ◀ SELECT ▶ key to operate the function menu. Press the ◀ ▶ key to move horizontally, and press SELECT to select.

The menu level changes. If there is no applicable menu item, the selection moves to the left menu item.

5.8.3 Mouse and Touch Panel Control

You can use the mouse or touch panel to control the keys on the screen to specify settings in the same manner as using the front panel keys. To display the keys, connect a mouse, and click in the screen or tap the screen.

Mouse and touch panel can be used at the same time.

To use touch panel control on the LV7600, connect the USB touch panel interface of a touch panel monitor using a USB cable. Connect the video interface of the touch panel monitor to the monitor output connector.

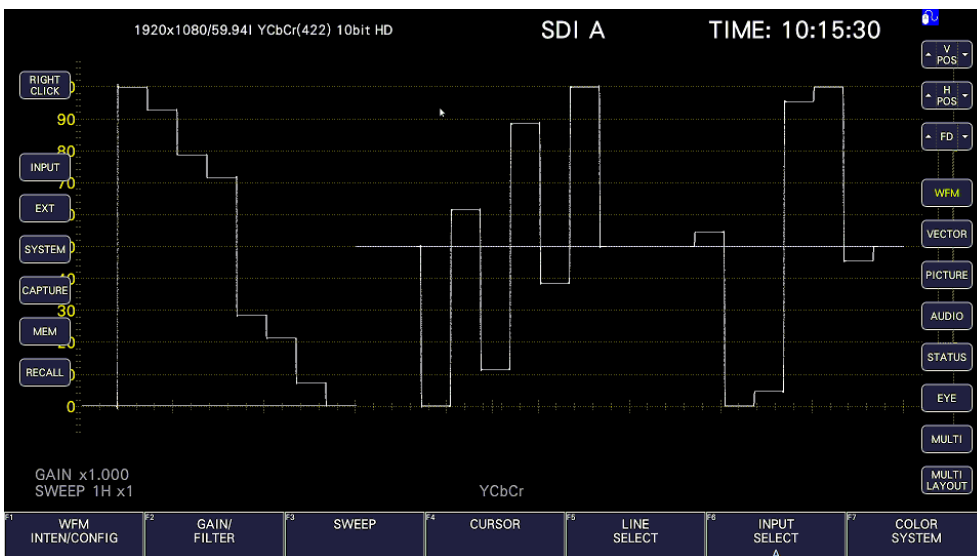

Figure 5-9 Mouse and touch panel control

- Measurement Screen Settings

Click or tap the keys on the screen and the function menu.

You can change a value in the function menu by using the ▲▼ key to the left and right of FD, the ▲▼ key to the left and right of the value, or the mouse wheel.

5. BEFORE YOU BEGIN MEASURING

- Tab Screen Settings

Click or tap the setting on the screen and the function menu.

You can change a value on a tab screen by using the ▲▼ key to the left and right of FD or the mouse wheel.

- Moving Cursors

Cursors on video signal waveforms can be moved easily with a mouse or touch panel.

When using a mouse, click a cursor to select it, and then click a position to move the cursor. To unselect, right-click. A portion of the cursors can be moved with a mouse wheel. If you use a mouse wheel, right-click to set the position.

When using the touch panel, tap a cursor to select it, and then tap a position to move the cursor.

- Right-Click Menu

Right-click the mouse or click or tap RIGHT CLICK at the upper left of the screen to display the following menu.

LAYOUT and ENHANCED LAYOUT are an item that can only be set using the mouse or touch panel.

Table 5-8 Right-click menu

Menu	Description
ALL CLEAR	Hides the keys and function menu from the screen. Click in the screen to redisplay them.
KEY CLEAR	Hides the keys from the screen. Click in the screen to redisplay them.
MENU CLEAR	Hides the function menu. Click in the screen to redisplay it.
LAYOUT	Creates a measurement screen layout. [See also] 6.5, "Customized Layout (SER26)"
ENHANCED LAYOUT	Creates a measurement screen layout. This option can be selected in simul mode. [See also] 6.6, "Enhanced Layout (SER26)"

5. BEFORE YOU BEGIN MEASURING

5.8.4 Tab Menu Operations

Normally, the function menus are used to configure the various settings. However, tab menus—such as that shown below—are displayed in some situations.

This section explains how to operate the tab menu, using the GENERAL tab menu as an example.

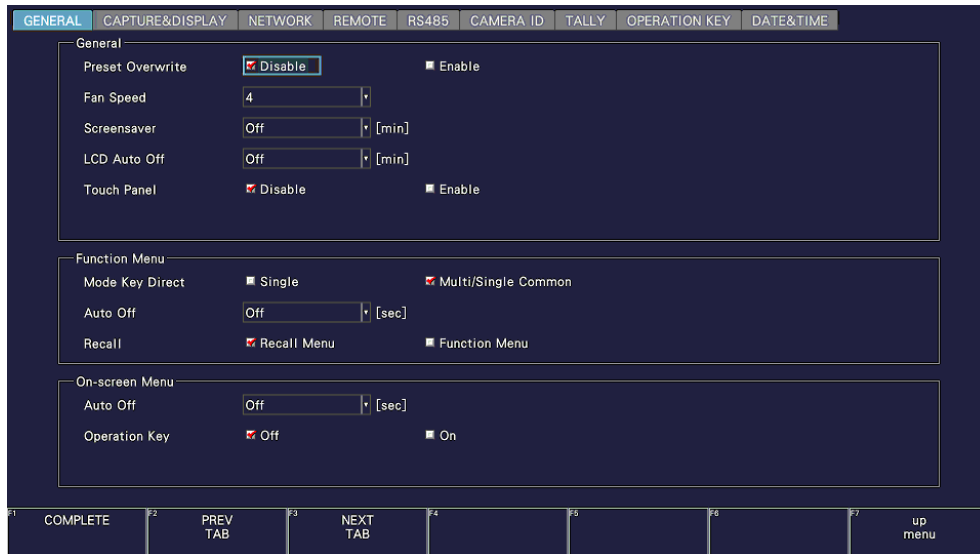

Figure 5-10 Tab menu operations

- Moving Cursors

To move the cursor, turn the function dial (F•D). Depending on what you are setting, there are some items in which you cannot move the cursor.

- Switching Tabs

When there are multiple tabs, such as in the figure above, **F•2** PREV TAB and **F•3** NEXT TAB to change between tabs. If you switch to another tab, the settings are retained, but they are not confirmed until you press **F•1** COMPLETE.

- Selecting a Check Box

Move the cursor to the check box that you want to select, and press the function dial (F•D).

- Entering Values

Move the cursor to the item that you want to enter the value for, and press the function dial (F•D). Turn the function dial (F•D) to set the value. To confirm the value that you have set, press the function dial (F•D) again.

- Confirming Settings

Press **F•1** COMPLETE to apply the settings from all the tabs and return to the screen that is one level up.

- Canceling Settings

Press **F•7** up menu to cancel the settings from all the tabs and return to the screen that is one level up.

5.8.5 Setting the Key Lock

You can prevent unintentional operations on the instrument by enabling the key lock. The key lock disables all the keys except for the power switch. Mouse and touch panel control are also disabled.

- Enabling the Key Lock

Hold down SYS until the following message is displayed on the screen. While the key lock is enabled, the key lock icon  appears in the upper right of the screen.

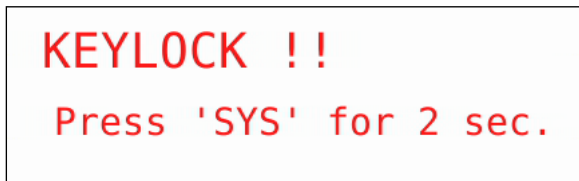

Figure 5-11 Enabling the key lock

- Releasing the Key Lock

Hold down SYS until the following message is displayed on the screen.

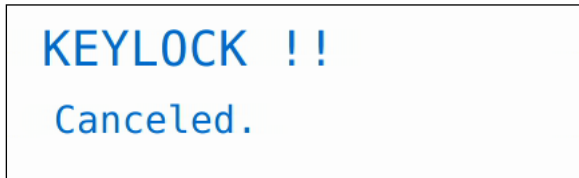

Figure 5-12 Releasing the key lock

5. BEFORE YOU BEGIN MEASURING

5.9 Measurement Screen Description

The measurement screen layout can be arranged as you like. This section explains items that are common to all displays.

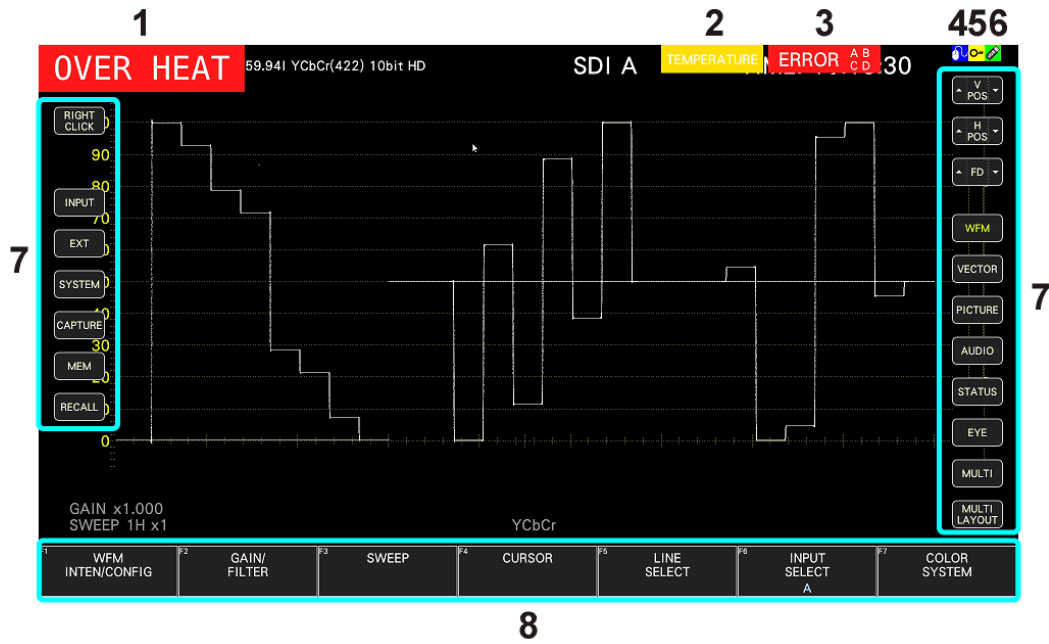

Figure 5-13 Measurement screen description

5. BEFORE YOU BEGIN MEASURING

Table 5-9 Measurement screen description

No.	Name	Description
1	OVER HEAT FAN ALARM	<p>“OVER HEAT” appears when the internal temperature increases. “FAN ALARM” appears when a fan error occurs.</p> <p>If “OVER HEAT” is displayed, increase the fan speed. If “OVER HEAT” is displayed and increasing the fan speed does not decrease the internal temperature, the power is automatically turned off.</p> <p>After the power is turned off, if you turn the power back on but “OVER HEAT” is displayed repetitively even when the fan speed is at maximum or if “FAN ALARM” is displayed, immediately turn off the power, and check the operating environment. If this alarm appears even though there are no problems with the operating environment, contact your local LEADER agent.</p> <p>[See also] 7.3, “Displaying System Information.” and 7.2.1, “General Settings.”</p>
2	TEMPERATURE	<p>Appears when the internal temperature increases. You can also choose to hide this information.</p> <p>If “TEMPERATURE” is displayed, increase the fan speed until the display disappears.</p> <p>[See also] 7.3, “Displaying System Information” and 7.2.1, “General Settings.”</p>
3	ERROR	<p>Appears when an input signal error occurs. (*1) You can also choose to hide this information.</p> <p>To configure error detection settings, use F•5 STATUS SETUP on the STATUS menu or F•4 ERROR SETUP on the EYE menu.</p> <p>[See also] 7.3, “Displaying System Information” and 7.2.1, “General Settings.”</p>
4	Mouse icon	<p>Appears when a USB mouse is connected or the USB interface of a touch panel monitor is connected. You can also choose to hide this information.</p> <p>[See also] 5.4, “Connecting USB Devices,” and 7.2.1, “General Settings”</p>
5	Key lock icon	<p>Appears when key lock is enabled. You can also choose to hide this information.</p> <p>[See also] 5.8.5, “Setting the Key Lock,” and 7.2.1, “General Settings”</p>
6	USB memory icon	<p>This appears when a USB memory device is connected. You can also choose to hide this information.</p> <p>[See also] 5.4, “Connecting USB Devices,” and 7.2.1, “General Settings”</p>
7	Screen keys	<p>Keys on the screen that you operate with a mouse or the touch panel.</p> <p>[See also] 5.8.3, “Mouse and Touch Panel Control”</p>
8	Function menu	<p>A menu for configuring settings.</p> <p>[See also] 5.8.1, “Displaying the Function Menu.”</p>

*1 All channels are applicable. However, when measuring 12G, 6G, 3G-B DS or 3G(DL)-4K, only on the currently displayed channels are applicable.

6. BASIC OPERATION

6.1 Setting the Input Signals

This section explains the INPUT menu settings and input format display.

6.1.1 Selecting the Input Mode

When SDI System on the SDI IN SETUP1 tab is set to 2K SD/HD/3G-A/3G-B-DL, 2K HD Dual Link, or 2K 3G Dual Link, to select the input mode, follow the procedure below.

Procedure

INPUT	→	F•7	DISPLAY: SINGLE / SIMUL
-------	---	-----	-------------------------

Settings

SINGLE:	The instrument operates in single input mode. It is a mode for measuring a single signal that has been turned on using F•1 to F•4.
SIMUL:	The instrument operates in simul mode. It is a mode for measuring multiple signals that have been turned on using F•1 to F•4.

DISPLAY = SINGLE

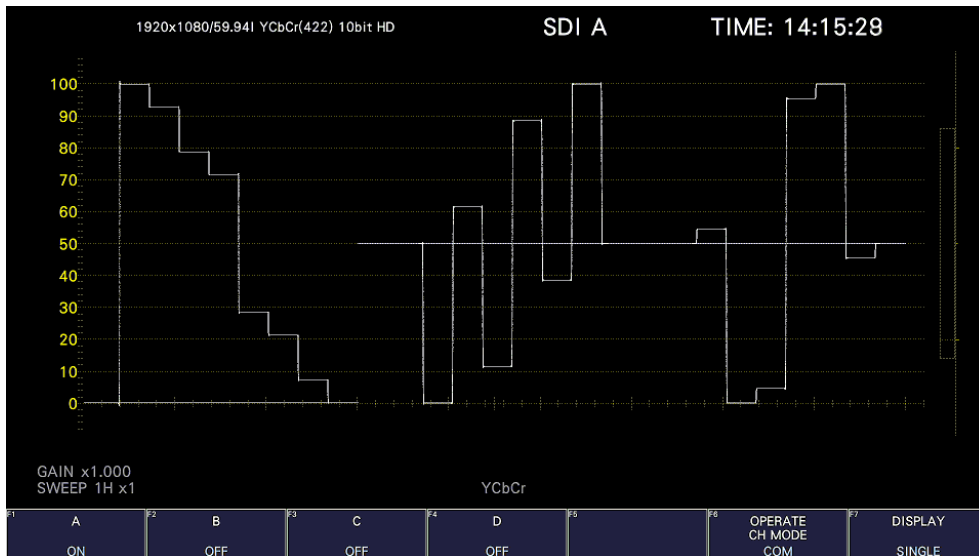

6. BASIC OPERATION

DISPLAY = SIMUL

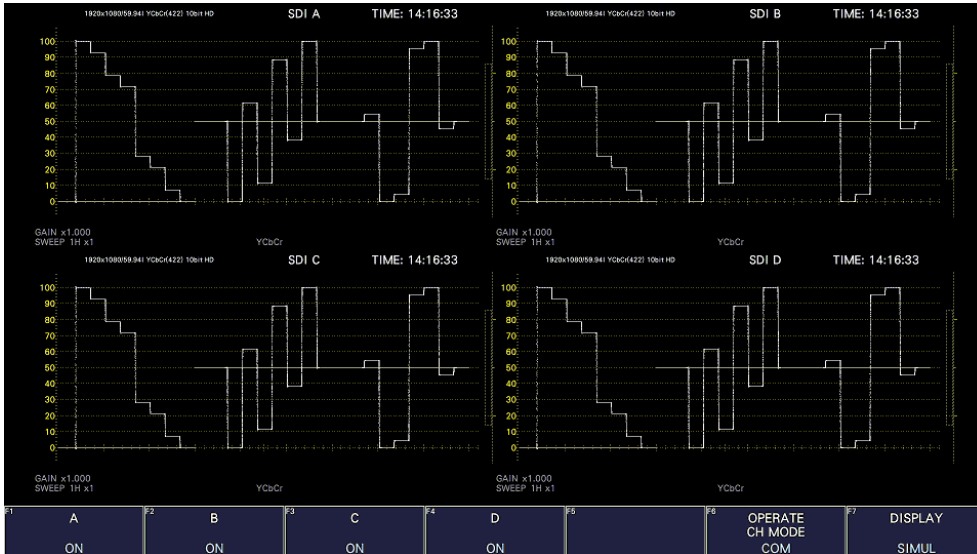

Figure 6-1 Selecting the input mode

6.1.2 Selecting the Simul Mode

When in simul mode, to select how to set each channel, follow the procedure below. If you change INDIVIDUAL to COM, all the settings are changed to those of the channel selected with **F•6** INPUT SELECT on each measurement screen.

Procedure

INPUT → **F•6** OPERATE CH MODE: COM / INDIVIDUAL

Settings

COM:	Measurement settings are made for all channels. A portion of the settings, such as the line selection when signals of different formats are applied, are not shared by all channels.
INDIVIDUAL:	Measurement settings are made for each channel. To select the channel you want to set, use F•6 INPUT SELECT on each measurement screen. A portion of the settings, such as ERROR CLEAR on the STATUS menu are shared by all channels.

6. BASIC OPERATION

6.1.3 Selecting the Displayed Channel

To select the channels to display, follow the procedure below.

On the SDI IN SETUP1 tab of the SYS menu, assign input signal to the display channels.

[See also] 7.1.2, "Input Signal Assignment"

Procedure (When the link format is set to single)

INPUT	
→ F•1	A: ON / OFF
→ F•2	B: ON / OFF
→ F•3	C: ON / OFF
→ F•4	D: ON / OFF

Procedure (for dual link)

INPUT	
→ F•1	A - B: ON / OFF
→ F•2	C - D: ON / OFF

Procedure (for quad link)

INPUT	
→ F•1	A - D: ON

You can also use F•6 INPUT SELECT on each measurement screen to select the display channels.

F•6 INPUT SELECT works as follows:

- In single input mode, select the display channel.
- When Through Out(SDI1) on the SDI OUT tab is Selection(A/B/C/D), select the signal to output from SDI OUTPUT 1.
- Selects that channel to be configured when F•6 OPERATE CH MODE of the INPUT menu is set to INDIVIDUAL.
- Selects where to recall captured frame data from.

6. BASIC OPERATION

6.1.4 Input Format Error Indication

If the format of the received signal is not appropriate for the setting specified on the SDI IN SETUP1 tab of the SYS menu, the instrument displays the format in red or an INPUT FORMAT window in the center of the screen. If this occurs, check the settings on the SDI IN SETUP1 tab, the input signal, and payload ID.

The format is displayed in red in the following situations.

- If the format is 2 sample interleave of 3G(DL)-4K or 3G(QL), and the order of the link is not correct
- When the SDI SYSTEM setting and the payload ID of the input signal are different
- When the payload ID is not appropriate

An INPUT FORMAT window is displayed in the following situations.

- If the input signal is multi link, and the format specified on the SDI IN SETUP1 tab is not received

[See also] SDI IN SETUP1 tab → 7.1.1, "Configuring the SDI Input Connectors."

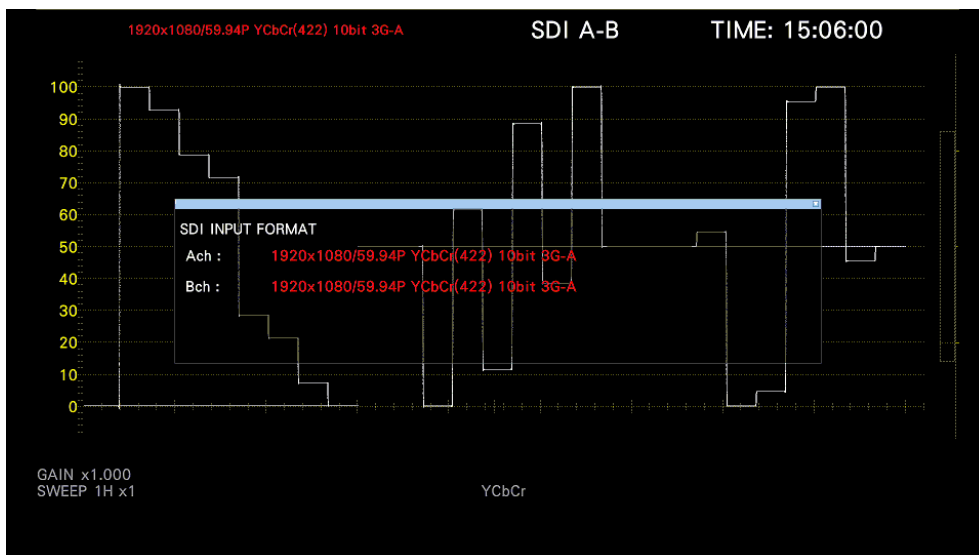

Figure 6-2 Input format error indication

6.2 Setting the Signals to Measure

This section explains the procedure from applying an input to displaying the measurement screen for each of the different input signal formats.

6.2.1 SD, HD, 3G-A, and 3G-B-DL Measurement

1. On the SDI IN SETUP1 tab of the SYS menu, set SDI System to 2K SD/HD/3G-A/3G-B-DL, and under Display Assignment, select the SDI signal channels to measure.

[See also] 7.1.1, "Configuring the SDI Input Connectors"

SYS → F•1 SIGNAL IN OUT → F•2 PREV TAB or F•3 NEXT TAB →

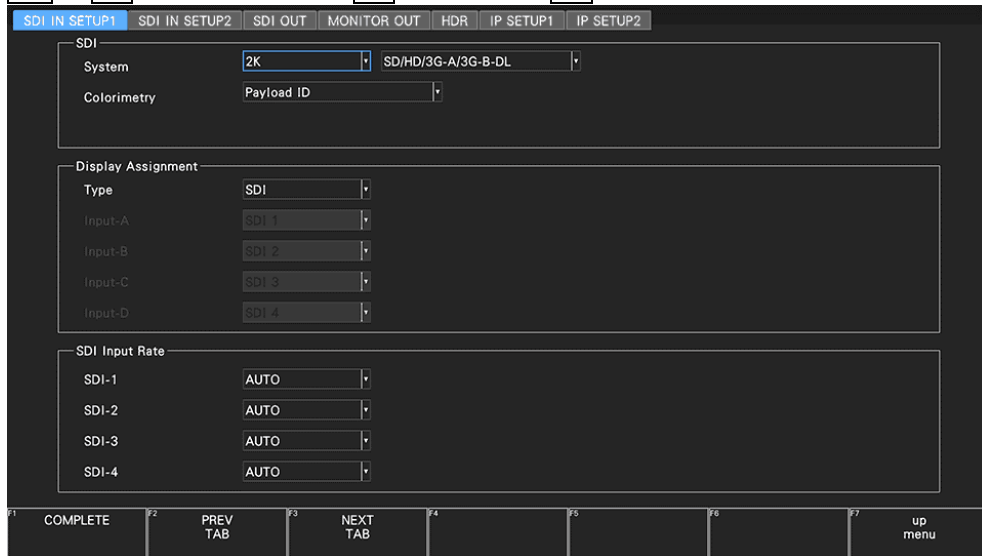

Figure 6-3 SDI IN SETUP1 tab

6. BASIC OPERATION

- If the input signal is HD or 3G, press **F•2** PREV TAB or **F•3** NEXT TAB, and under SETTING on the SDI IN SETUP2 tab, set the payload ID.

Select Use or Not Use. If you select Not Use, specify the following settings.

- HD: Set i/PsF Select.
- 3G-A, 3G-B-DL: Set i/PsF Select, Color System, and Pixel Depth.

[See also] 7.1.4, "Setting the Payload ID"

SYS → **F•1** SIGNAL IN OUT → **F•2** PREV TAB or **F•3** NEXT TAB →



Figure 6-4 SDI IN SETUP2 tab

- Press COMPLETE.
- Apply SDI signals to the SDI INPUT connectors on the rear panel.

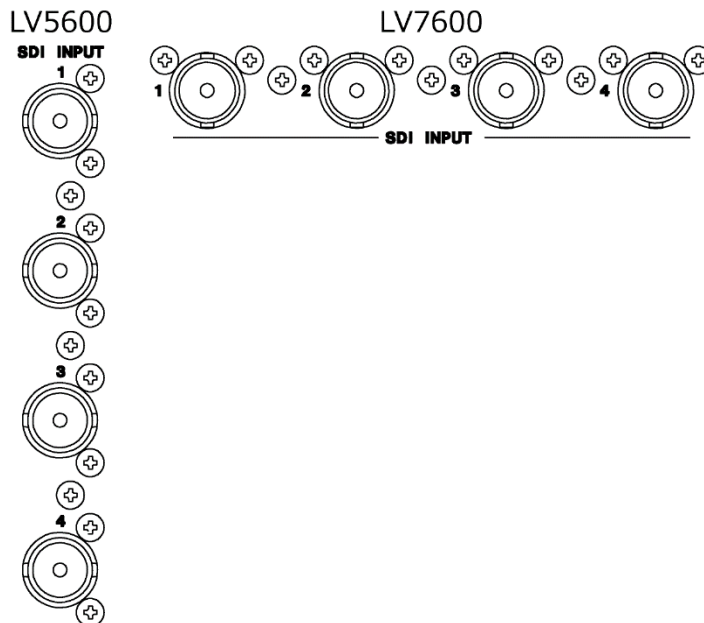

Figure 6-5 SDI input connectors

6. BASIC OPERATION

- Press INPUT to select the channels you want to measure.

Press **F•7** DISPLAY to select whether to measure a single channel (SINGLE) or multiple channels (SIMUL).

Press **F•1** to **F•4** to turn on the channels you want to measure.

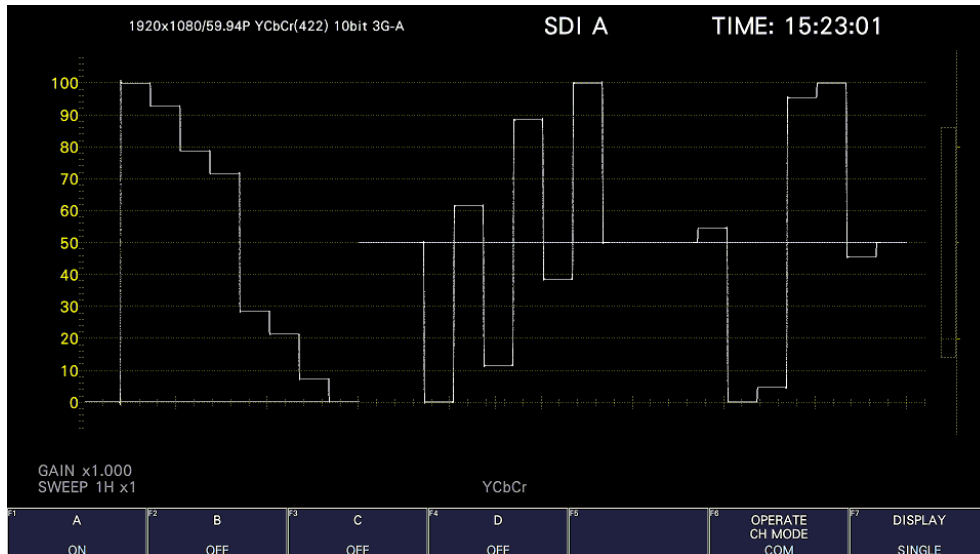

Figure 6-6 Measurement screen

6.2.2 Measuring HD(DL) Signals

- On the SDI IN SETUP1 tab of the SYS menu, set SDI System to 2K HD Dual Link.

[See also] 7.1.1, "Configuring the SDI Input Connectors"

SYS → **F•1** SIGNAL IN OUT → **F•2** PREV TAB or **F•3** NEXT TAB →

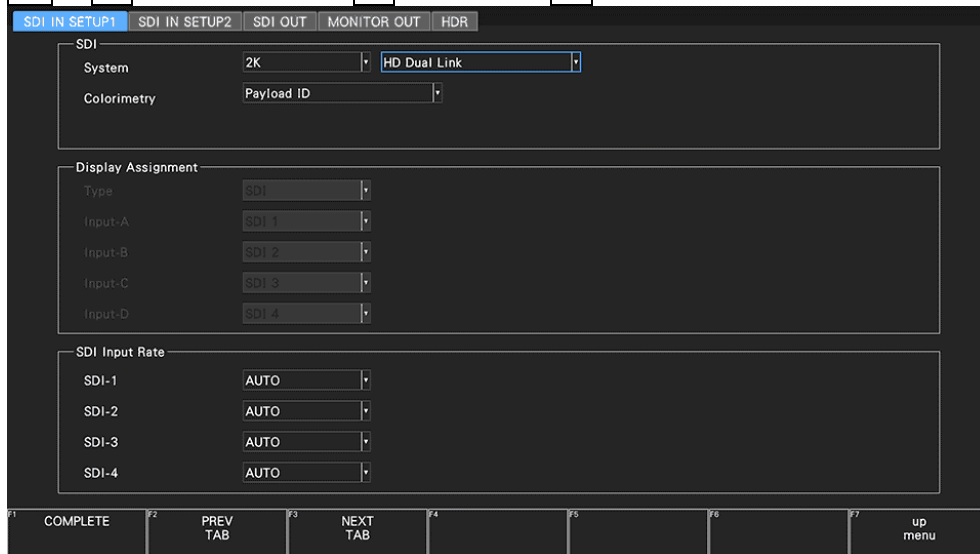

Figure 6-7 SDI IN SETUP1 tab

6. BASIC OPERATION

- Press **F•2** PREV TAB or **F•3** NEXT TAB, and under SETTING on the SDI IN SETUP2 tab, set the payload ID.

Select Use or Not Use. If you select Not Use, set i/PsF Select, Color System, and Pixel Depth.

Even if Use is selected, if a HD signal is applied, it will be detected as an HD(DL) signal. [See also] 7.1.4, "Setting the Payload ID"

SYS → **F•1** SIGNAL IN OUT → **F•2** PREV TAB or **F•3** NEXT TAB →



Figure 6-8 SDI IN SETUP2 tab

- Press COMPLETE.
- Apply HD Dual Link signals to the SDI INPUT connectors on the rear panel. Connectors 1 and 2 and connectors 3 and 4 are pairs.

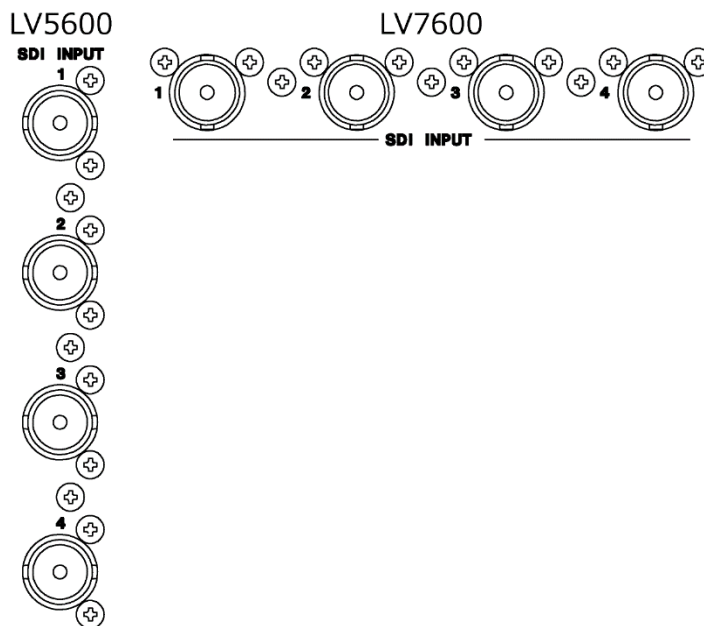

Figure 6-9 SDI input connectors

6. BASIC OPERATION

- Press INPUT to select the channels you want to measure.

Press **F•7** DISPLAY to select whether to measure a single channel (SINGLE) or multiple channels (SIMUL).

Press **F•1** and **F•2** to turn on the channels you want to measure.

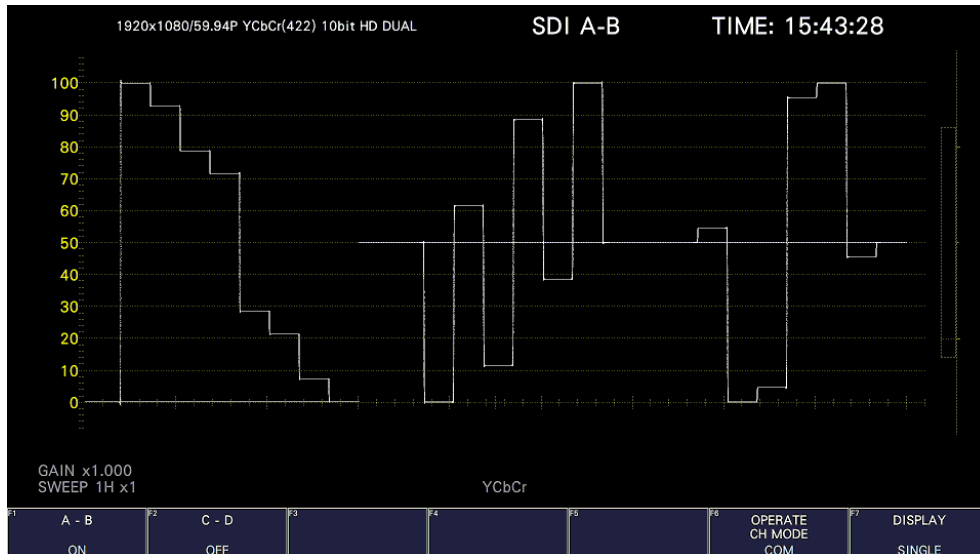

Figure 6-10 Measurement screen

6.2.3 Measuring 3G(DL)-2K Signals

- On the SDI IN SETUP1 tab of the SYS menu, set SDI System to 2K 3G Dual Link.

[See also] 7.1.1, "Configuring the SDI Input Connectors"

SYS → **F•1** SIGNAL IN OUT → **F•2** PREV TAB or **F•3** NEXT TAB →

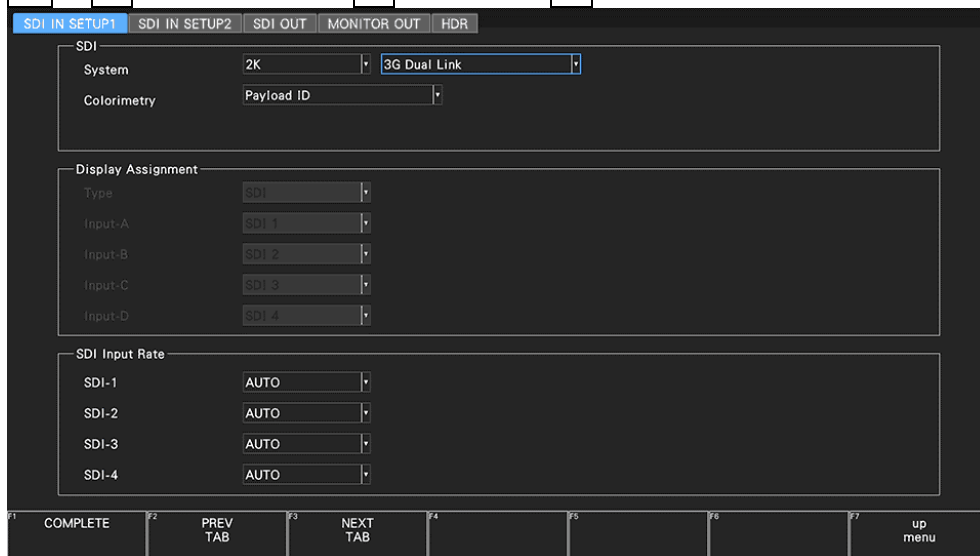

Figure 6-11 SDI IN SETUP1 tab

6. BASIC OPERATION

- Press **F•2** PREV TAB or **F•3** NEXT TAB, and under SETTING on the SDI IN SETUP2 tab, set the payload ID.

Select Use or Not Use. If you select Not Use, set Color System and Pixel Depth.

Even if Use is selected, if a 3G-A or 3G-B-DL signal is applied, it will be detected as a 3G(DL)-2K signal.

[See also] 7.1.4, "Setting the Payload ID"

SYS → **F•1** SIGNAL IN OUT → **F•2** PREV TAB or **F•3** NEXT TAB →



Figure 6-12 SDI IN SETUP2 tab

- Press COMPLETE.
- Apply a 2K 3G Dual Link signal to the SDI INPUT connectors on the rear panel. Connectors 1 and 2 and connectors 3 and 4 are pairs.

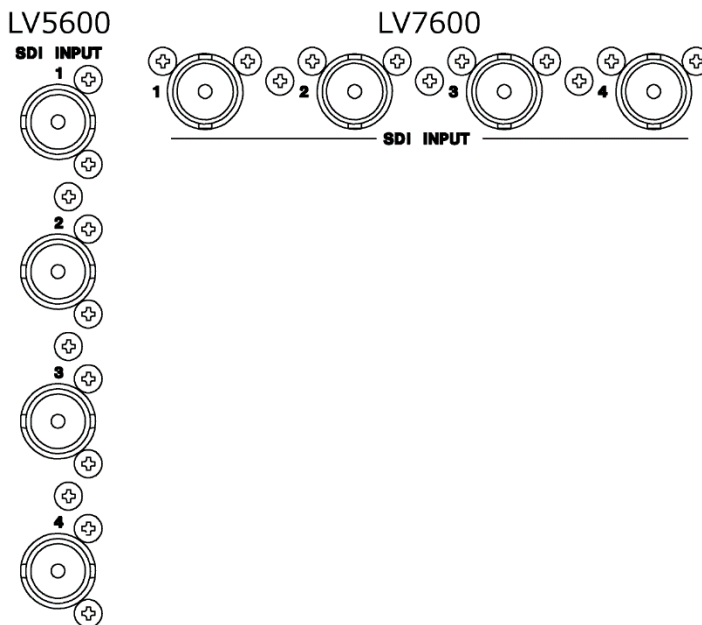

Figure 6-13 SDI input connectors

6. BASIC OPERATION

5. Press INPUT to select the channels you want to measure.

Press **F•7** DISPLAY to select whether to measure a single channel (SINGLE) or multiple channels (SIMUL).

Press **F•1** and **F•2** to turn on the channels you want to measure.

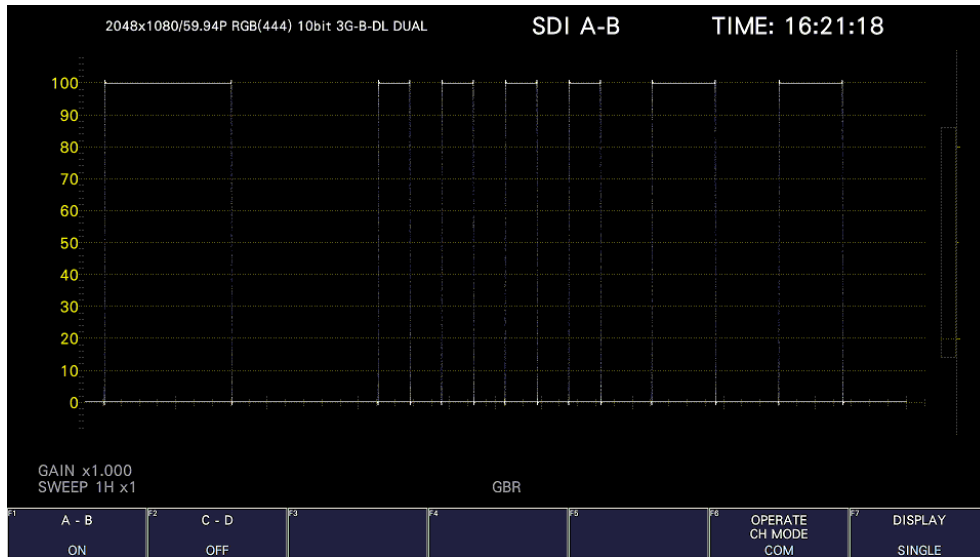

Figure 6-14 Measurement screen

6.2.4 Measuring 3G-B DS Signals

1. On the SDI IN SETUP1 tab of the SYS menu, set SDI System to 2K 3G-B DS.

[See also] 7.1.1, "Configuring the SDI Input Connectors"

SYS → **F•1** SIGNAL IN OUT → **F•2** PREV TAB or **F•3** NEXT TAB →

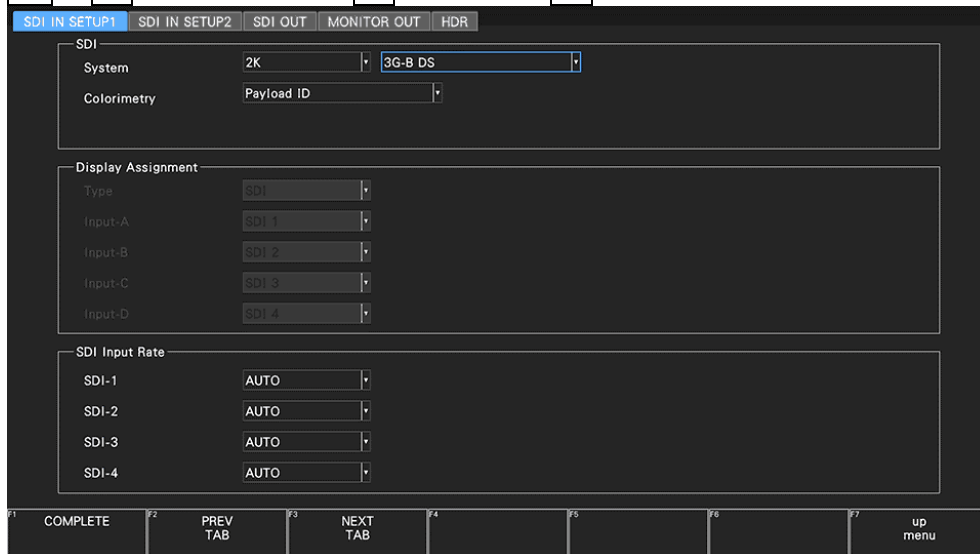

Figure 6-15 SDI IN SETUP1 tab

6. BASIC OPERATION

2. Press **F•2** PREV TAB or **F•3** NEXT TAB, and under SETTING on the SDI IN SETUP2 tab, set the payload ID.

Select Use or Not Use. If you select Not Use, set i/PsF Select.

Even if Use is selected, if a 3G-B-DL signal is applied, the instrument will detect is as a 3G-B DS signal.

[See also] 7.1.4, "Setting the Payload ID"

SYS → **F•1** SIGNAL IN OUT → **F•2** PREV TAB or **F•3** NEXT TAB →



Figure 6-16 SDI IN SETUP2 tab

3. Press COMPLETE.
4. Apply 3G-B DS signals to the SDI INPUT connectors on the rear panel.

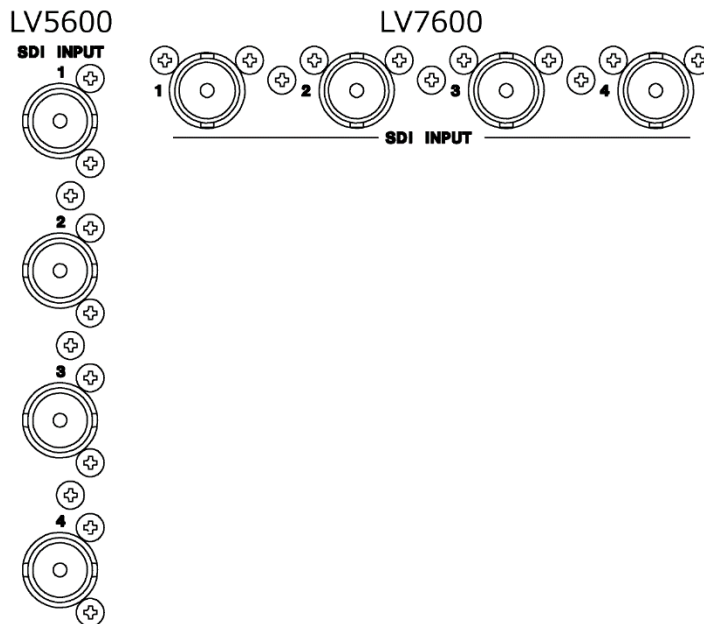

Figure 6-17 SDI input connectors

6. BASIC OPERATION

- Press INPUT to select the channels you want to measure.

Press **F•1** to **F•4** to turn on the channels you want to measure. Simul mode cannot be used.

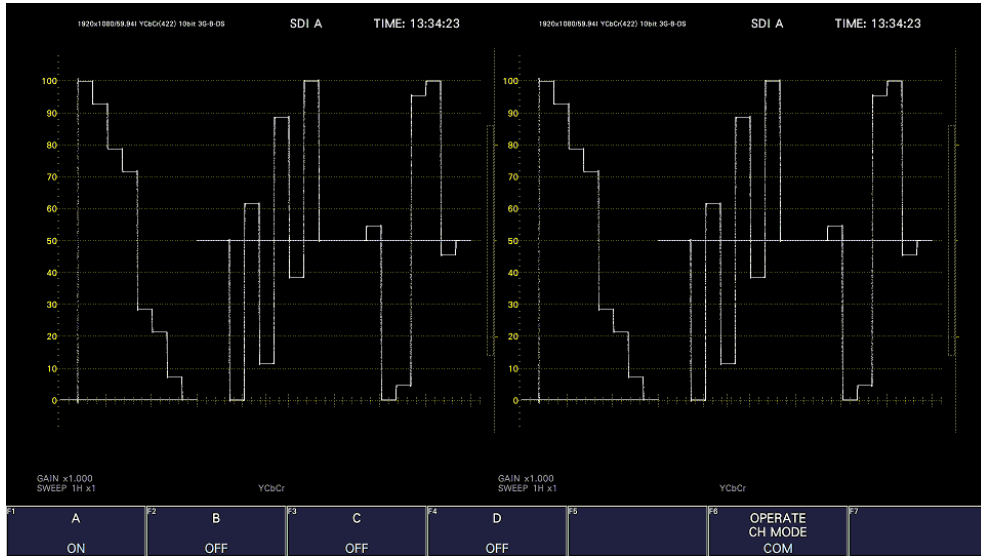

Figure 6-18 Measurement screen

6.2.5 Measuring 6G Signals (SER28/SER29)

- On the SDI IN SETUP1 tab of the SYS menu, set SDI System to 4K 6G.

[See also] 7.1.1, “Configuring the SDI Input Connectors”

SYS → **F•1** SIGNAL IN OUT → **F•2** PREV TAB or **F•3** NEXT TAB →

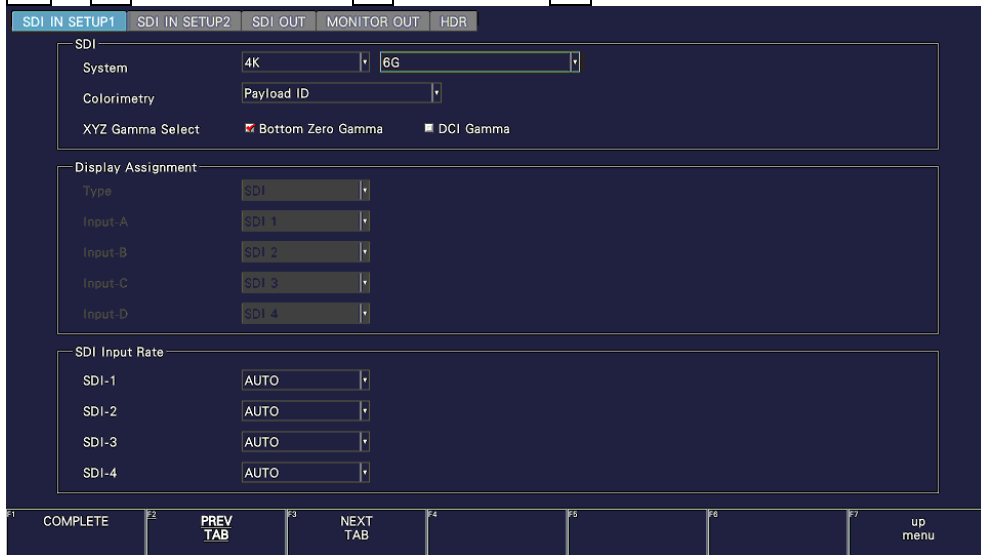

Figure 6-19 SDI IN SETUP1 tab

6. BASIC OPERATION

- Press **F•2** PREV TAB or **F•3** NEXT TAB, and under SETTING on the SDI IN SETUP2 tab, set the payload ID.

Select Use or Not Use.

[See also] 7.1.4, "Setting the Payload ID"

Only 2 sample interleave is supported for the division transmission system.

SYS → **F•1** SIGNAL IN OUT → **F•2** PREV TAB or **F•3** NEXT TAB →



Figure 6-20 SDI IN SETUP2 tab

- Press COMPLETE.
- Apply 4K 6G signals to the SDI INPUT connectors on the rear panel.

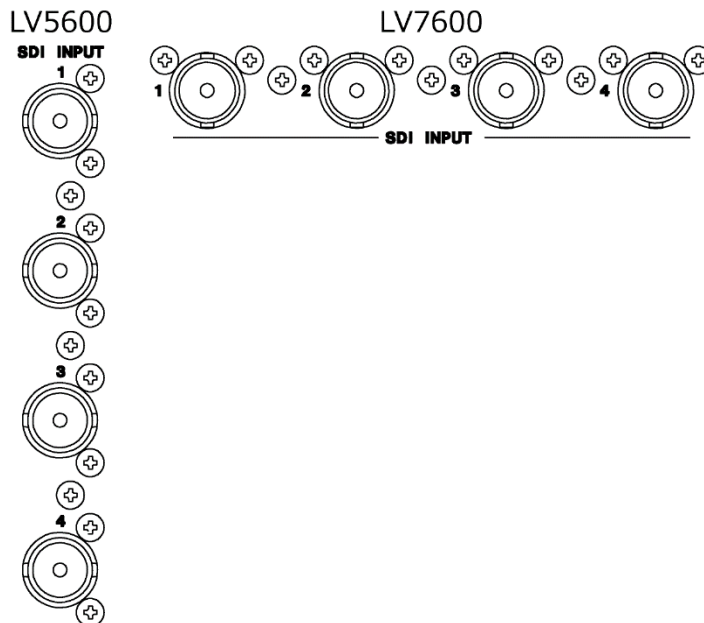

Figure 6-21 SDI input connectors

6. BASIC OPERATION

- Press INPUT to select the channels you want to measure.

Press **F•1** to **F•4** to turn on the channels you want to measure. Simul mode cannot be used.

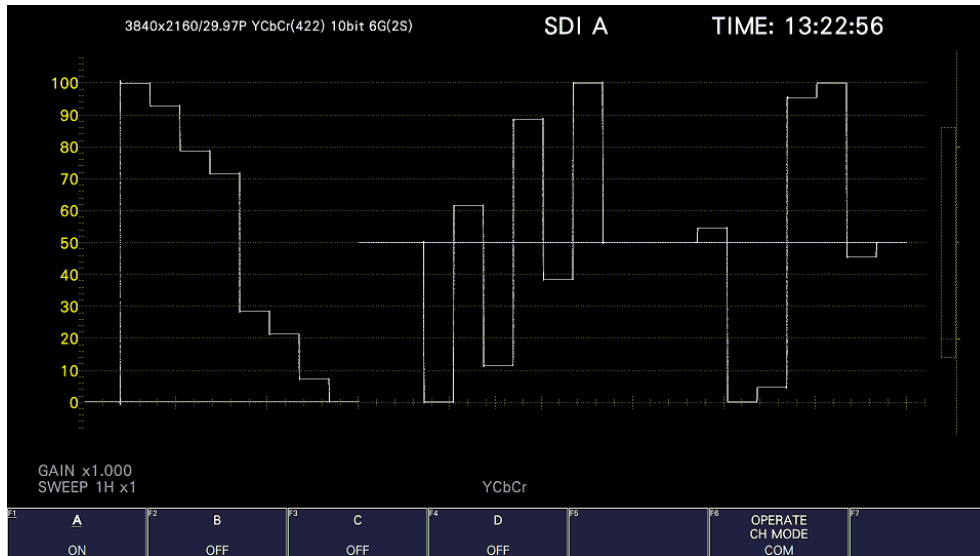

Figure 6-22 Measurement screen

- * To measure 6G-SDI signals, use cables and connectors that are appropriate for transmitting 6G-SDI signals. Using incompatible or degraded cables or connectors may cause the transmission characteristics to degrade drastically.

6.2.6 Measuring 12G Signals (SER28/SER29)

- On the SDI IN SETUP1 tab of the SYS menu, set SDI System to 4K 12G.

[See also] 7.1.1, "Configuring the SDI Input Connectors"

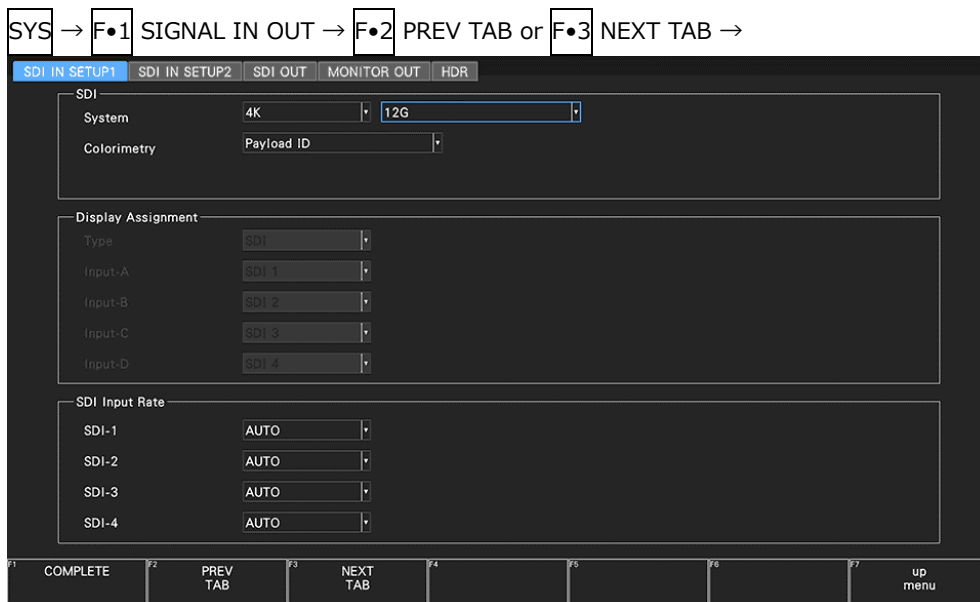

Figure 6-23 SDI IN SETUP1 tab

6. BASIC OPERATION

- Press **F•2** PREV TAB or **F•3** NEXT TAB, and under SETTING on the SDI IN SETUP2 tab, set the payload ID.

Select Use or Not Use. If you select Not Use, set Color System, and Pixel Depth.

[See also] 7.1.4, "Setting the Payload ID"

Only 2 sample interleave is supported for the division transmission system.

SYS → **F•1** SIGNAL IN OUT → **F•2** PREV TAB or **F•3** NEXT TAB →



Figure 6-24 SDI IN SETUP2 tab

- Press COMPLETE.
- Apply 12G signals to the SDI INPUT connectors on the rear panel.

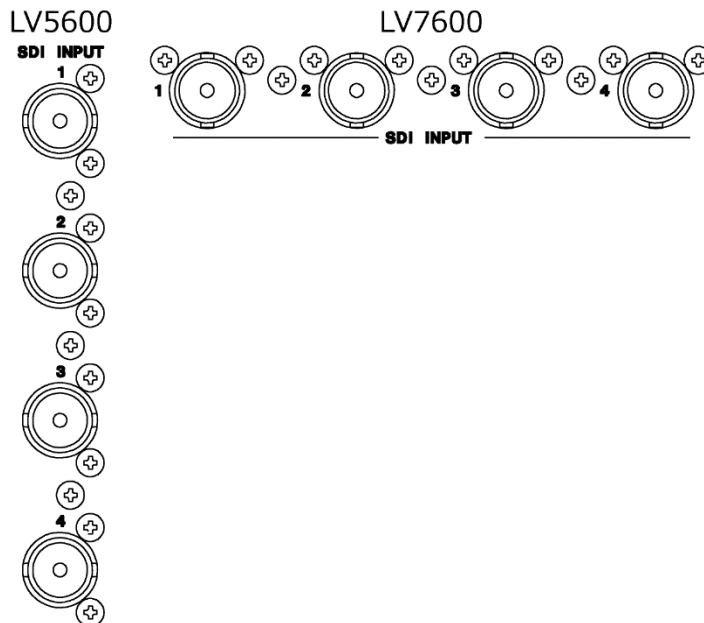

Figure 6-25 SDI input connectors

6. BASIC OPERATION

- Press INPUT to select the channels you want to measure.

Press **F•1** to **F•4** to turn on the channels you want to measure. Simul mode cannot be used.

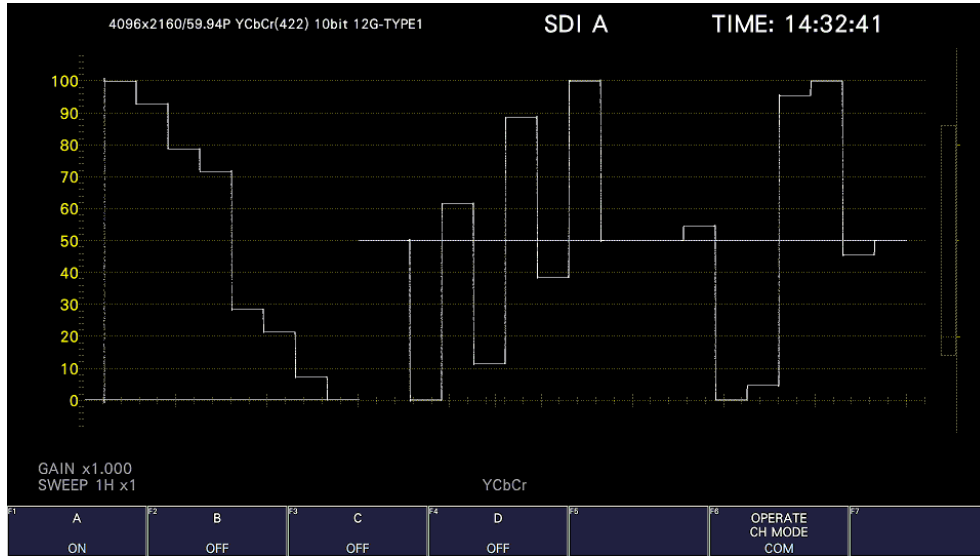

Figure 6-26 Measurement screen

- * To measure 12G-SDI signals, use cables and connectors that are appropriate for transmitting 12G-SDI signals. Using incompatible or degraded cables or connectors may cause the transmission characteristics to degrade drastically.

6.2.7 Measuring 3G(QL) Signals (SER28)

- On the SDI IN SETUP1 tab of the SYS menu, set SDI System to 4K 3G Quad Link.

[See also] 7.1.1, "Configuring the SDI Input Connectors"

SYS → **F•1** SIGNAL IN OUT → **F•2** PREV TAB or **F•3** NEXT TAB →

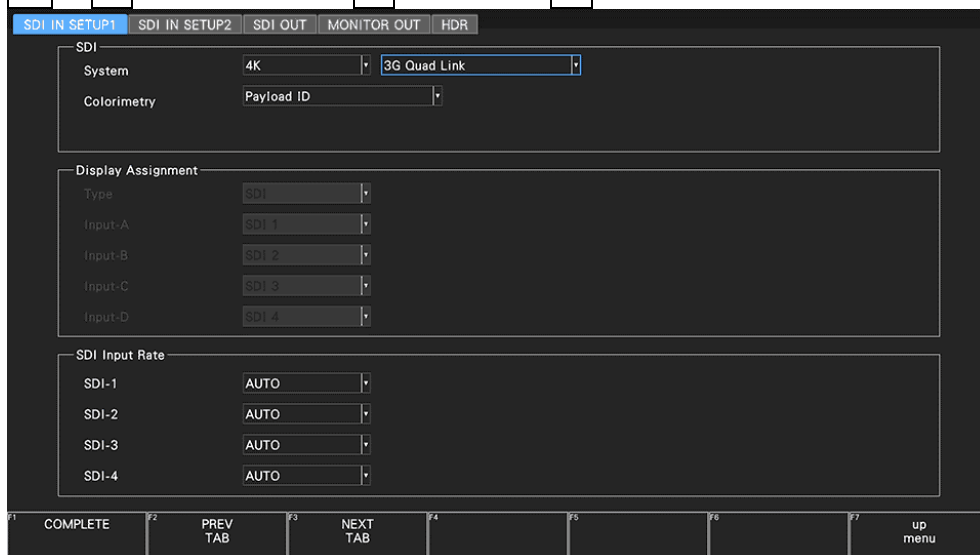

Figure 6-27 SDI IN SETUP1 tab

6. BASIC OPERATION

- Press **F•2** PREV TAB or **F•3** NEXT TAB, and under SETTING on the SDI IN SETUP2 tab, set the payload ID.

Select Use or Not Use. If you select Not Use, set Division, Color System, and Pixel Depth.

The Psf format does not support 2 sample interleave.

Even if Use is selected, if a 3G-B DS signal is applied, it will be detected as a 3G-B-DL signal.

[See also] 7.1.4, "Setting the Payload ID"

SYS → **F•1** SIGNAL IN OUT → **F•2** PREV TAB or **F•3** NEXT TAB →



Figure 6-28 SDI IN SETUP2 tab

- Press COMPLETE.
- Apply a 3G-A or 3G-B-DL signal to the SDI INPUT connectors on the rear panel.

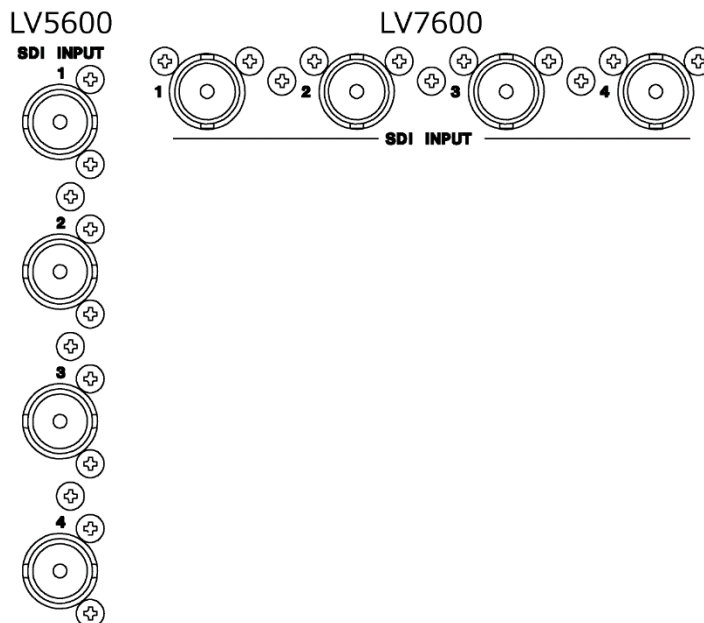

Figure 6-29 SDI input connectors

6. BASIC OPERATION

- Channels to be measured are fixed to **F•1** ON.

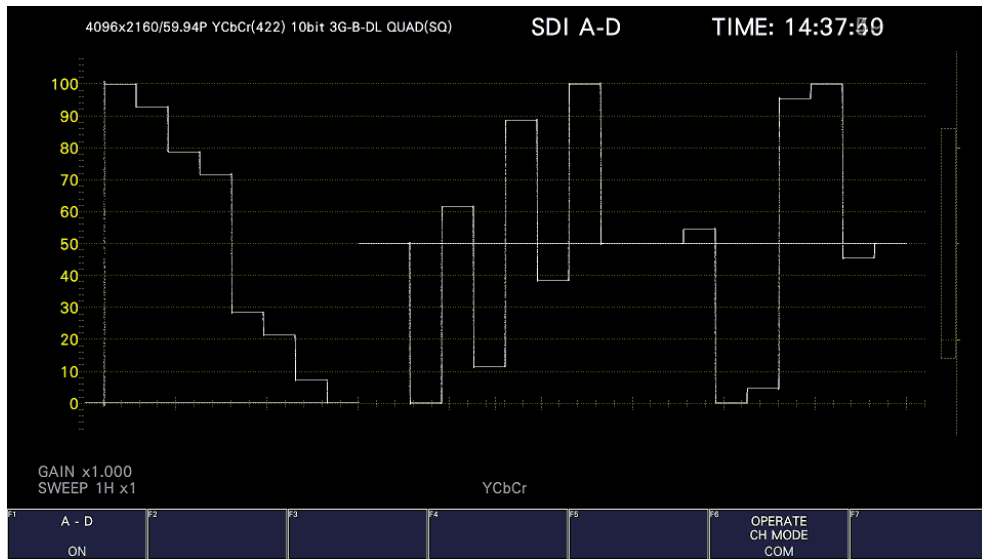

Figure 6-30 Measurement screen

6.2.8 Measuring 3G(DL)-4K Signals (SER28)

- On the SDI IN SETUP1 tab of the SYS menu, set SDI System to 4K 3G Dual Link.

[See also] 7.1.1, "Configuring the SDI Input Connectors"

SYS → **F•1** SIGNAL IN OUT → **F•2** PREV TAB or **F•3** NEXT TAB →

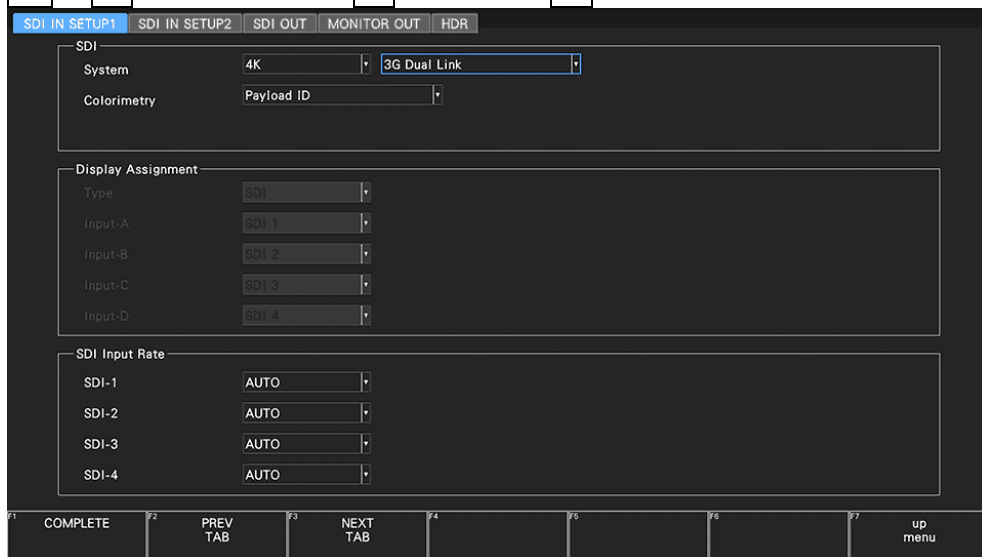

Figure 6-31 SDI IN SETUP1 tab

6. BASIC OPERATION

- Press **F•2** PREV TAB or **F•3** NEXT TAB, and under SETTING on the SDI IN SETUP2 tab, set the payload ID.

Select Use or Not Use. If you select Not Use, set Division.

The Psf format does not support 2 sample interleave.

Even if Use is selected, if a 3G-B-DL signal is applied, it will be detected as a 3G-B DS signal.

[See also] 7.1.4, "Setting the Payload ID"

SYS → **F•1** SIGNAL IN OUT → **F•2** PREV TAB or **F•3** NEXT TAB →



Figure 6-32 SDI IN SETUP2 tab

- Press COMPLETE.
- Apply 3G-B DS signals to the SDI INPUT connectors on the rear panel. Connectors 1 and 2 and connectors 3 and 4 are pairs.

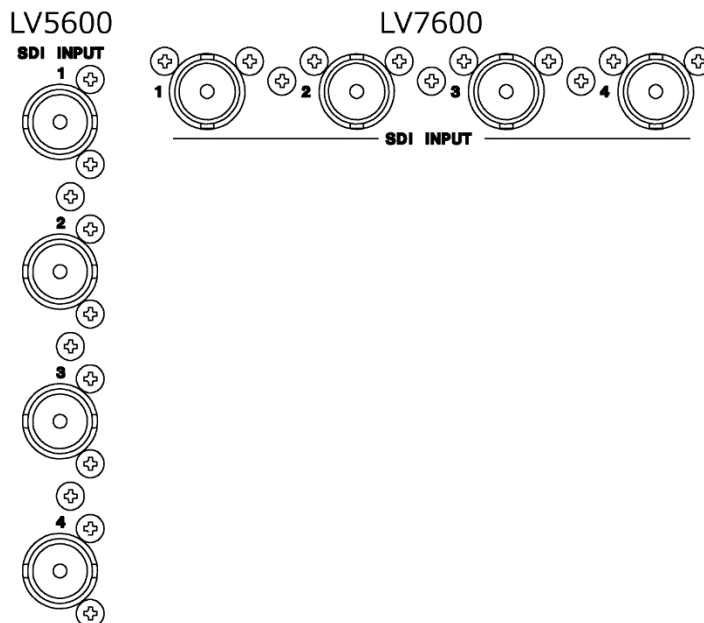

Figure 6-33 SDI input connectors

6. BASIC OPERATION

5. Press INPUT to select the channels you want to measure.

Press **F•1** and **F•2** to turn on the channels you want to measure. Simul mode cannot be used.

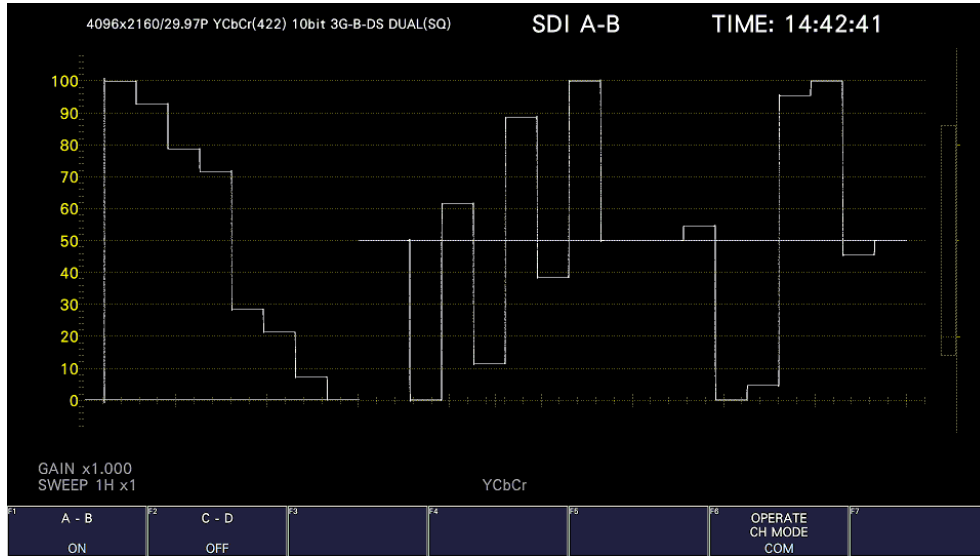

Figure 6-34 Measurement screen

6.2.9 Measuring HD(QL) Signals (SER28)

1. On the SDI IN SETUP1 tab of the SYS menu, set SDI System to 4K HD Quad Link.

[See also] 7.1.1, "Configuring the SDI Input Connectors"

Only square is supported for the division transmission system.

SYS → **F•1** SIGNAL IN OUT → **F•2** PREV TAB or **F•3** NEXT TAB →

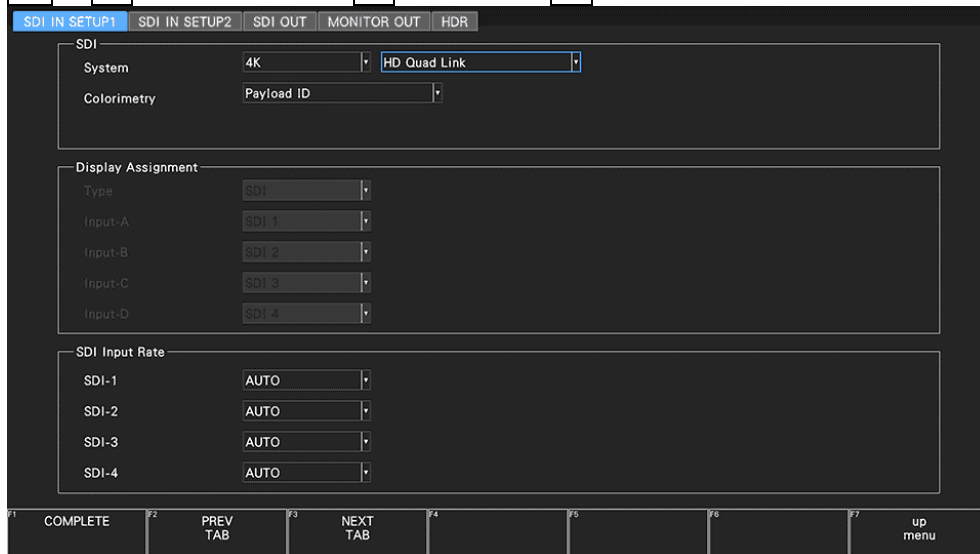

Figure 6-35 SDI IN SETUP1 tab

2. Press COMPLETE.

6. BASIC OPERATION

3. Apply HD signals to the SDI INPUT connectors on the rear panel.

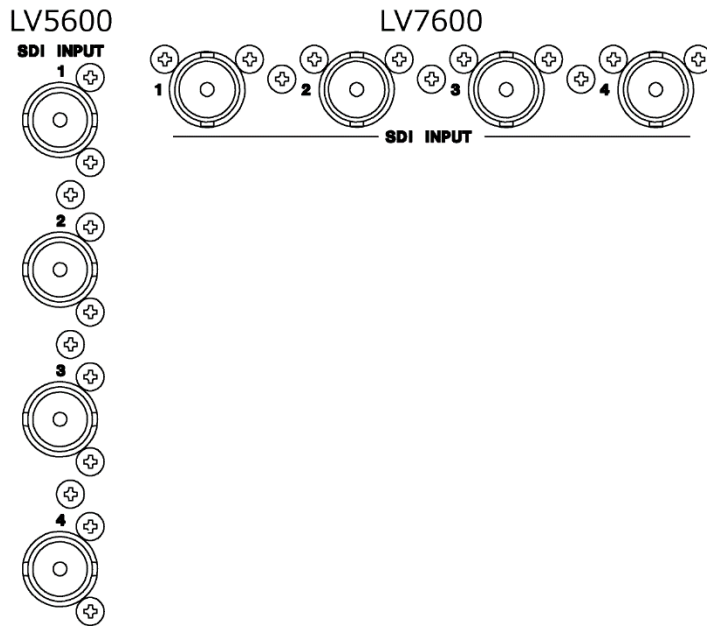

Figure 6-36 SDI input connectors

4. Channels to be measured are fixed to **F•1** ON.

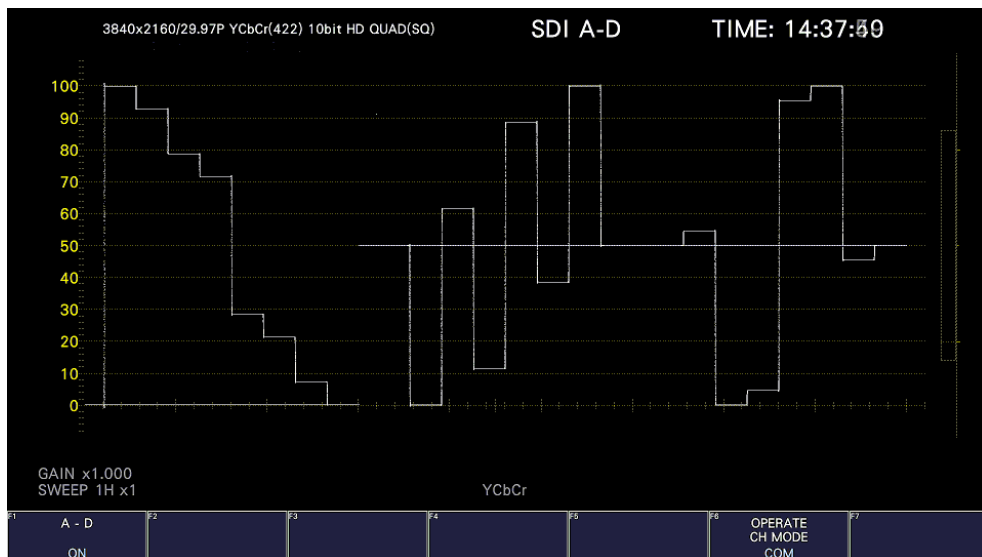

Figure 6-37 Measurement screen

6. BASIC OPERATION

6.2.10 IP Measurement (SER05/SER06)

1. On the SDI IN SETUP1 tab of the SYS menu, set SDI System to 2K SD/HD/3G-A/3G-B-DL/IP. Then, for Display Assignment, select IP signal.

Set Display Assignment Type to IP (when the SER26 is not installed), or assign IP Stream1 to 4 to Input-A to D (when the SER26 is installed).

[See also] 7.1.1, "Configuring the SDI Input Connectors"

SYS → F•1 SIGNAL IN OUT → F•2 PREV TAB or F•3 NEXT TAB →

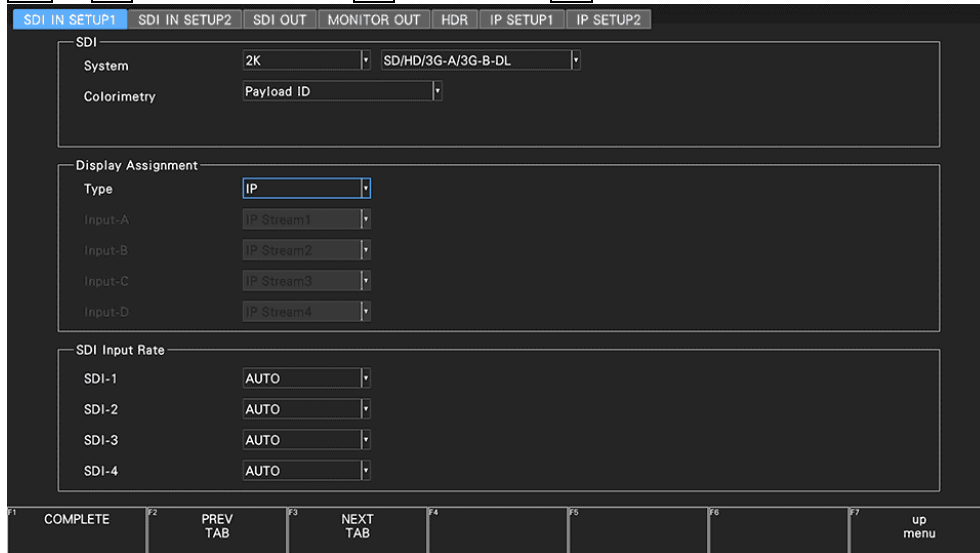

Figure 6-38 SDI IN SETUP1 tab

6. BASIC OPERATION

- Press **F•2** PREV TAB or **F•3** NEXT TAB, and set the parameters on the IP SETUP1 tab.
Set the signal standard, IP address, and port number.
You can set the IP address and port number for each stream. Also you can assign by pressing a single key on the status screen.
[See also] 7.1.10, "Configuring the IP Signal Settings (SER05/SER06)," 16.8.2, "Configuring the IP Status Screen"

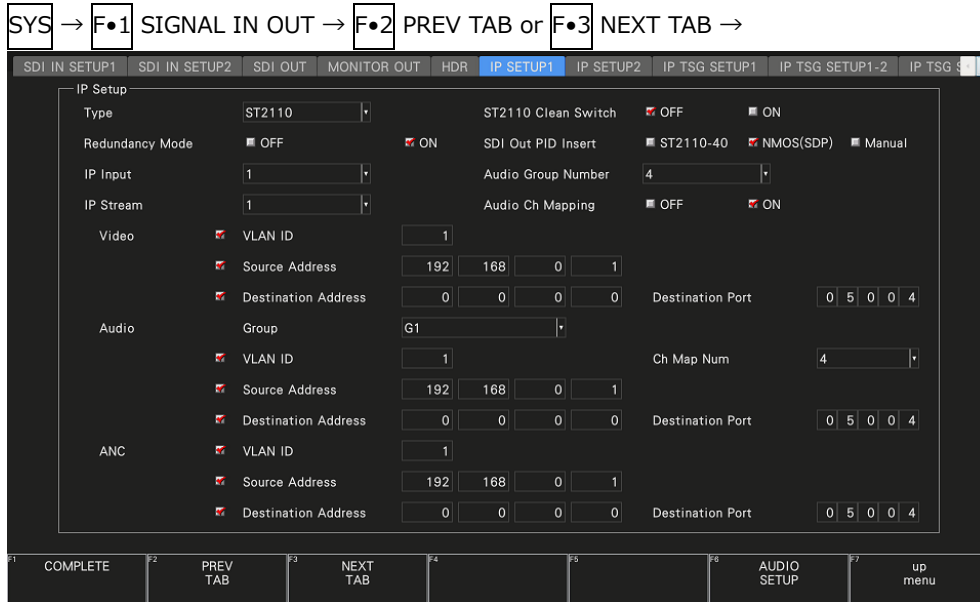

Figure 6-39 IP SETUP1 tab

- Press **F•3** NEXT TAB, and set the parameters on the IP SETUP2 tab.
Set the PTP domain number and the video format for when the signal standard is ST2110.
[See also] 7.1.11, "Configuring the PTP Settings (SER05/SER06)," and 7.1.12, "Setting the Video Format (SER05/SER06)"

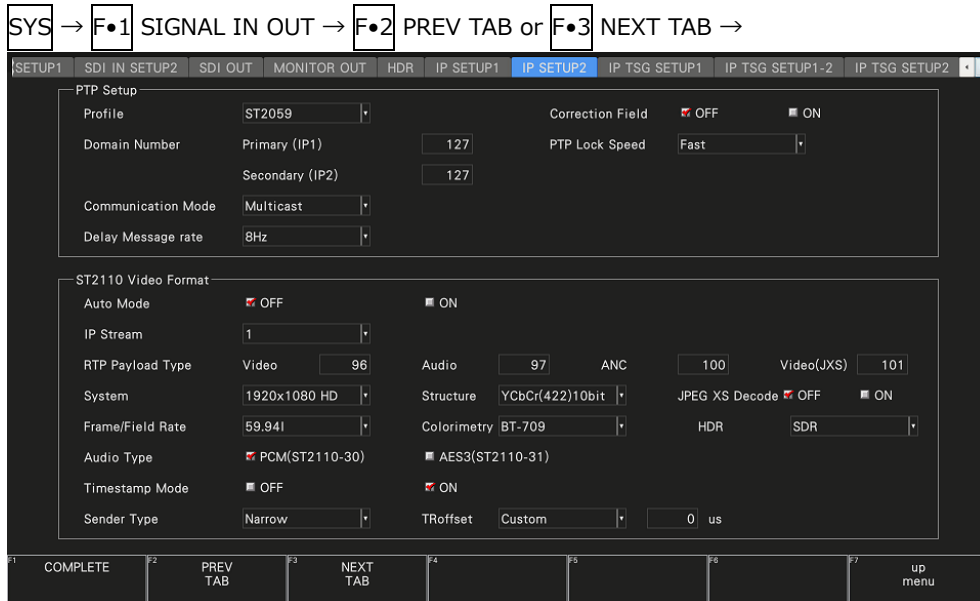

Figure 6-40 IP SETUP2 tab

6. BASIC OPERATION

4. Press **F•1** COMPLETE.

5. Install SFP transceiver modules into the IP area of the rear panel, and apply IP signals.

When the signal standard is ST2110 or when Redundancy Mode is set to OFF, apply the signal to IP 1.

When Redundancy Mode is set to ON, apply the signal to IP 1 and 2.

[See also] 5.5, "Installing the SFP+ Module (SER05)," 5.6, "Installing the SFP+/SFP28 Module (SER06)," and 5.7.2, "Applying IP Signals (SER05/SER06)"

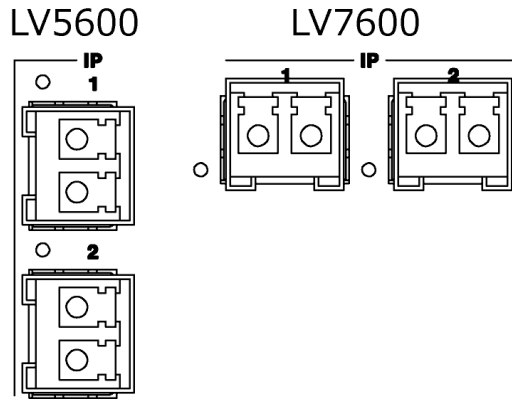

Figure 6-41 IP input/output connectors

6. Press INPUT to select the channels (streams) you want to measure.

Press **F•7** DISPLAY to select whether to measure a single channel (SINGLE) or multiple channels (SIMUL).

Press **F•1** to **F•4** to turn on the channels you want to measure. If the SER26 is not installed, channels A to D are assigned streams 1 to 4.

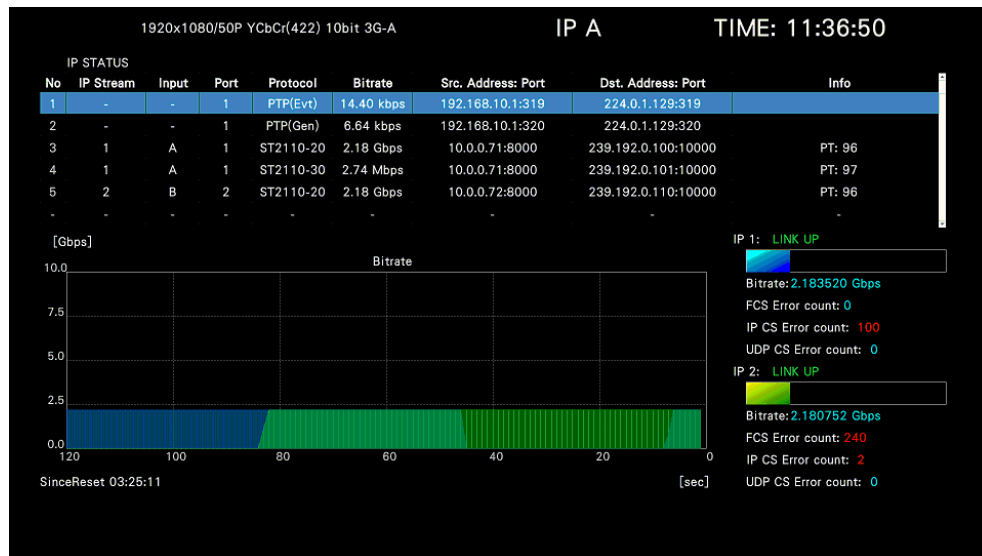

Figure 6-42 Measurement screen

6. BASIC OPERATION

6.3 Selecting the Measurement Mode

The types of measurement screens available are WFM, VECT, PIC, AUDIO, STATUS, and EYE. There is also another type, MULTI, that combines these six types. Press a mode key on the front panel to select the type.

6.3.1 Video Signal Waveform Display

To display video signal waveforms, press WFM.

The available features include line select display, which displays the waveform of the selected line, RGB display, pseudo-composite display, and external sync signal waveform display.

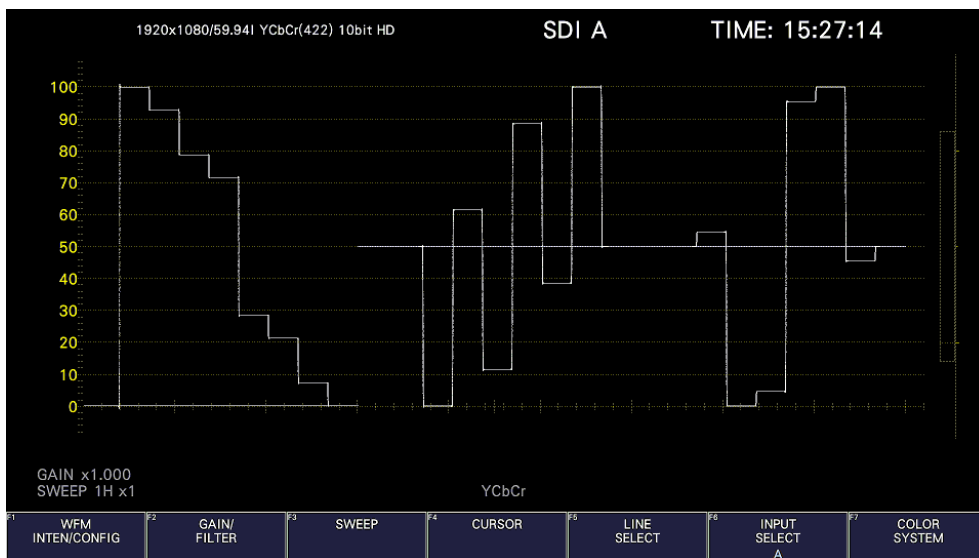

Figure 6-43 Video signal waveform display

6. BASIC OPERATION

6.3.2 Vector Display

To display vectors, press VECT.

The available features include line select display, marker display, pseudo-composite display, 5-bar display, and CIE chromaticity diagram display.

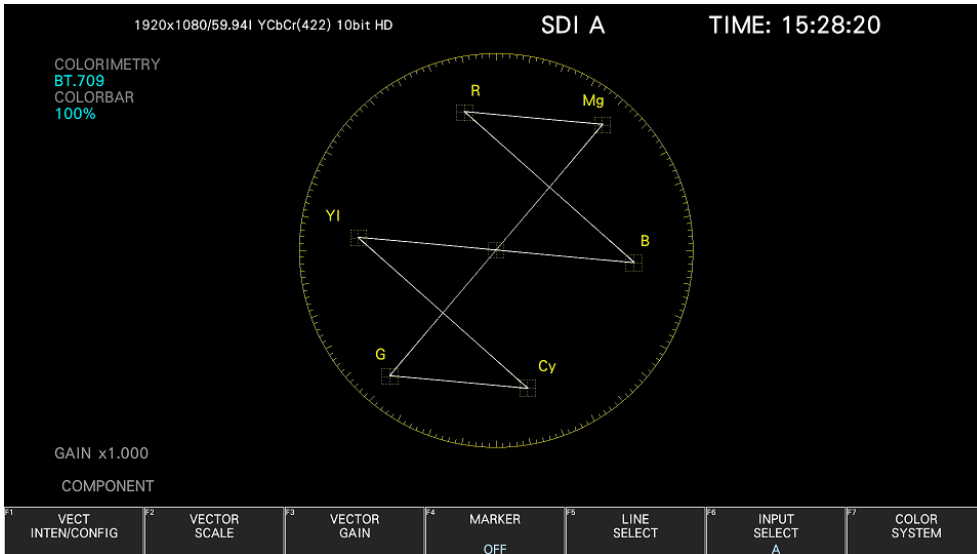

Figure 6-44 Vector display

6.3.3 Picture Screen

To show the picture display, press PIC.

The available features include monochrome display, marker display, line select display, and focus assist display (SER25).

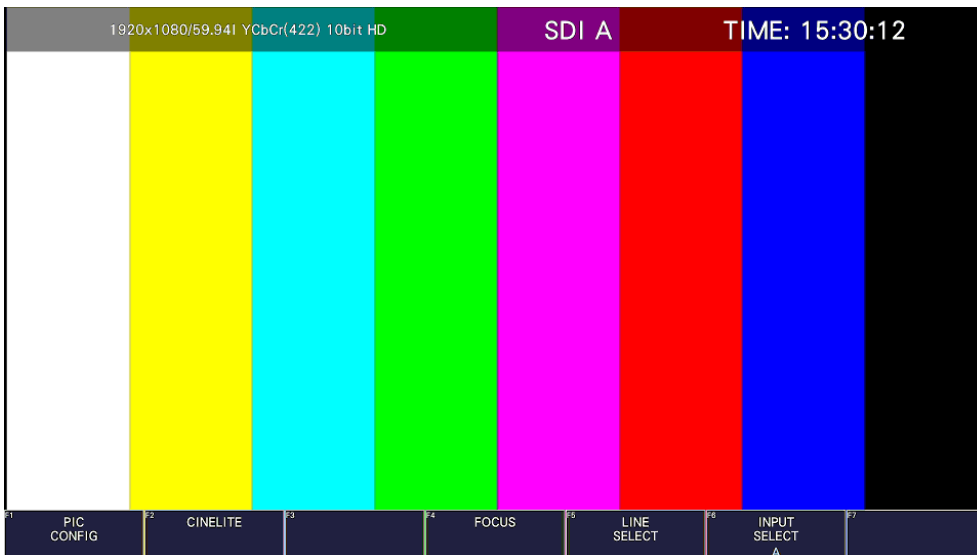

Figure 6-45 Picture display

6. BASIC OPERATION

6.3.4 Audio Display

To show the audio display, press AUDIO.

The available features include 8 channels meter display, 16 channels meter display (SER03), Lissajous display (SER03), surround display (SER03), status display (SER03), and loudness display (SER03) of the signal selected with **F•7** MAPPING.

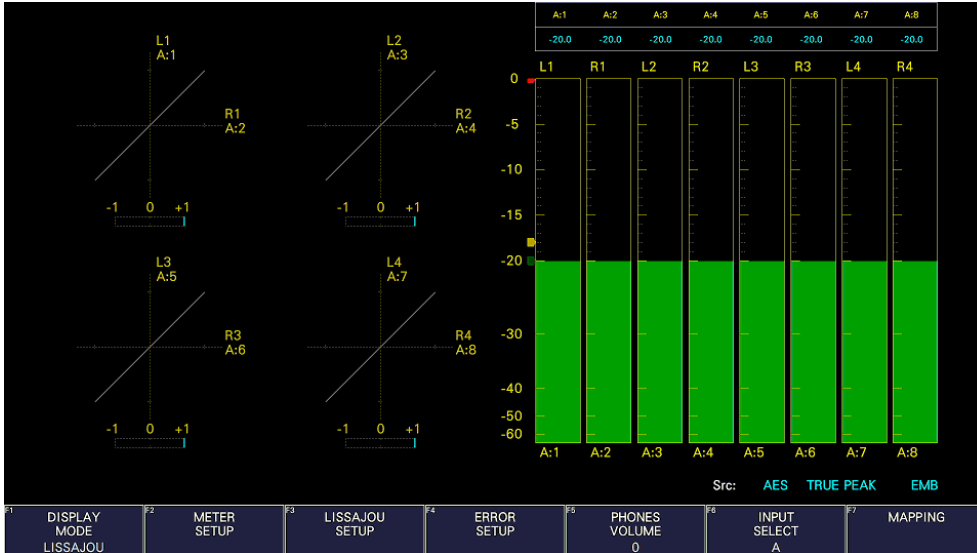

Figure 6-46 Audio display

6.3.5 Status Display

To show the status display, press STATUS.

Event log display and data dump display are available.

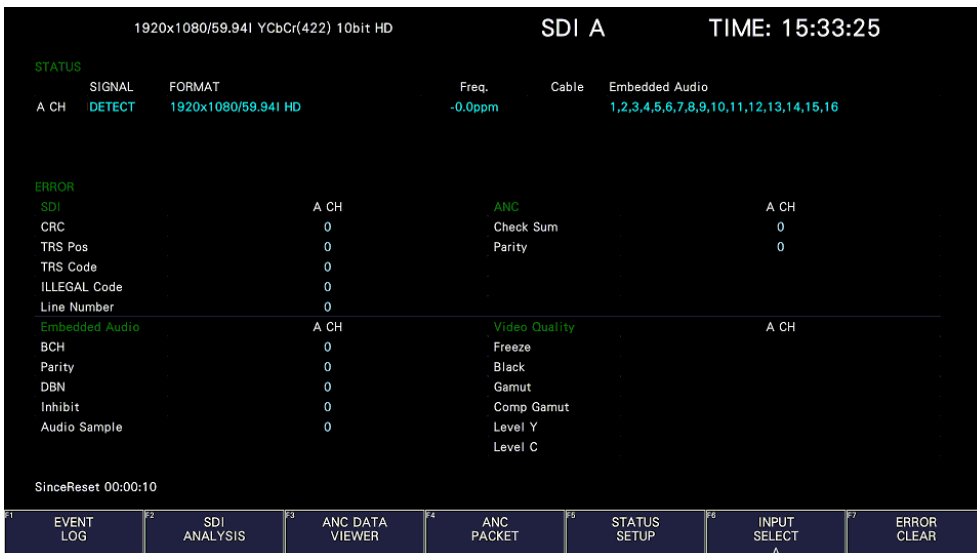

Figure 6-47 Status display

6. BASIC OPERATION

6.3.6 Eye Pattern Display (SER02/SER02A)

To show eye patterns, press EYE. (If SER02/SER02A is not installed, the EYE key is disabled.)

You can also show jitter by switching **F•1** EYE/JITTER MODE.

Simul mode is not supported.

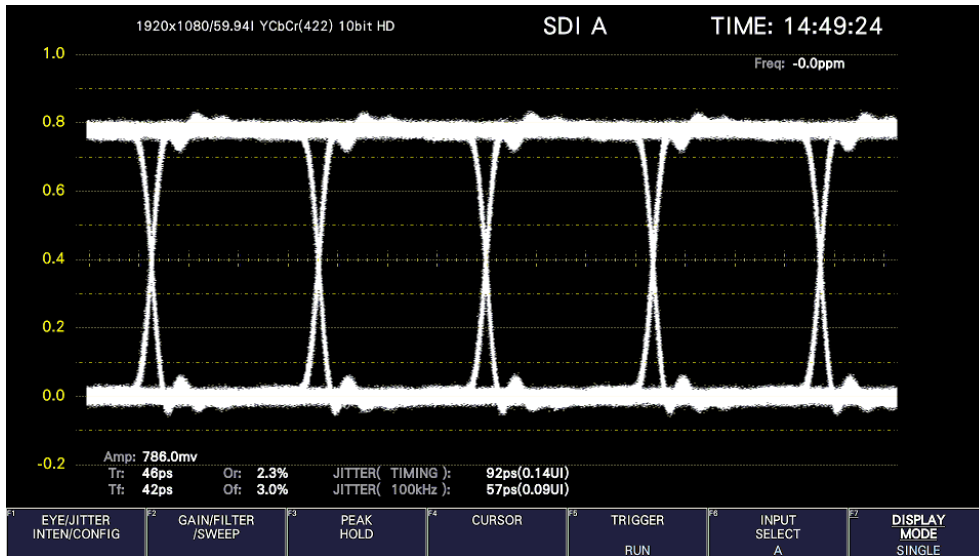

Figure 6-48 Eye pattern display

6.3.7 Multi Display

To show a multi screen, which is a combination of measurement screens, press MULTI.

If Mode Key Direct on the GENERAL tab is set to Single, you can select between six types of layouts by using **F•1** LAYOUT SELECT.

To set each measurement screen, use **F•2** MULTI WFM MENU to **F•7** MULTI EYE MENU.

If Mode Key Direct on the GENERAL tab is set to Multi/Single Common, you can switch between measurement screens by pressing MULTI. To select the layout, hold MULTI down for 2 seconds to display the function menu. Then select using **F•1** LAYOUT USER 1 to **F•6** LAYOUT USER 6.

[See also] GENERAL tab → 7.2.1, "General Settings"

6. BASIC OPERATION

- USER 1

The vector, video signal waveform, status, and picture are displayed in four divided screens.

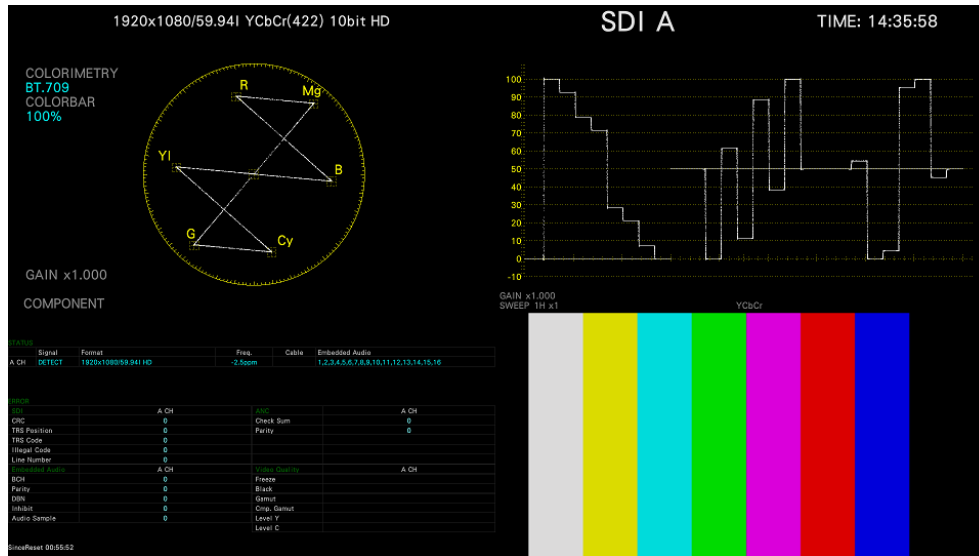

Figure 6-49 Multi display (USER 1, Single Mode)

- USER 2

The picture is displayed in the main screen, and the video signal waveform and vector are displayed as thumbnails.

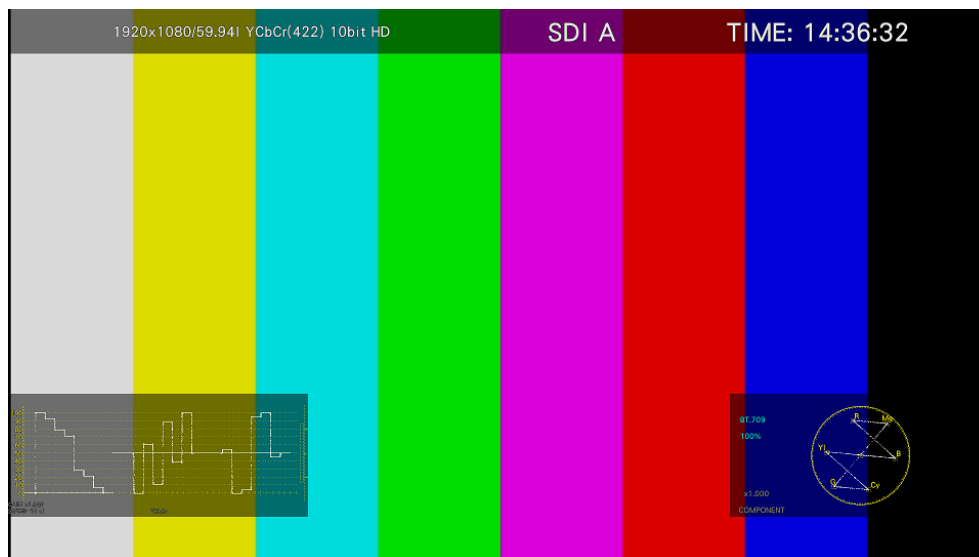

Figure 6-50 Multi display (USER 2, Single Mode)

6. BASIC OPERATION

- USER 3

The vector is displayed in the main screen, and the video signal waveform and picture are displayed as thumbnails.

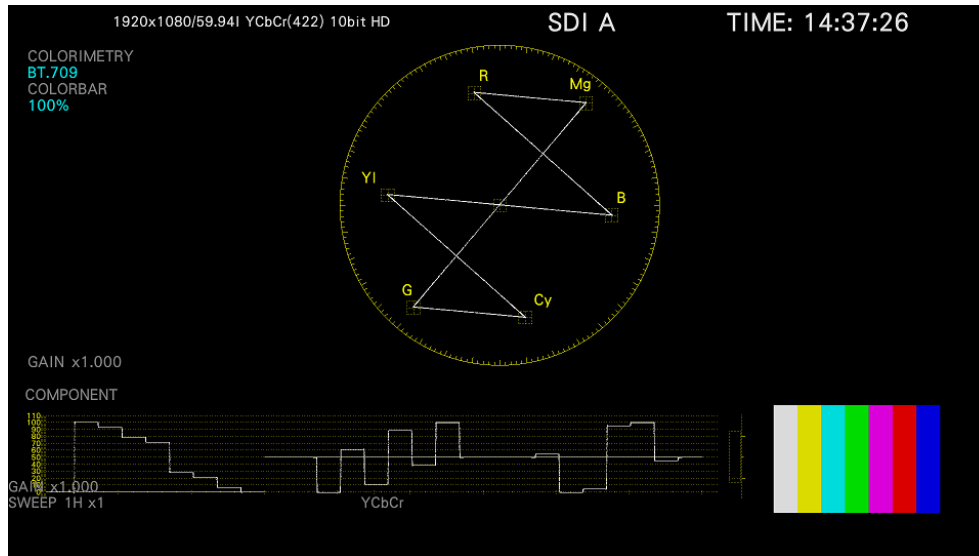

Figure 6-51 Multi display (USER 3, Single Mode)

- USER 4

The picture, video-signal-waveform, and vector are displayed top to bottom. This is suitable for simul mode.



Figure 6-52 Multi display (USER 4, Simul Mode)

6. BASIC OPERATION

- USER 5

The picture and video signal waveform are displayed in the top and bottom screens. This is suitable for simul mode.

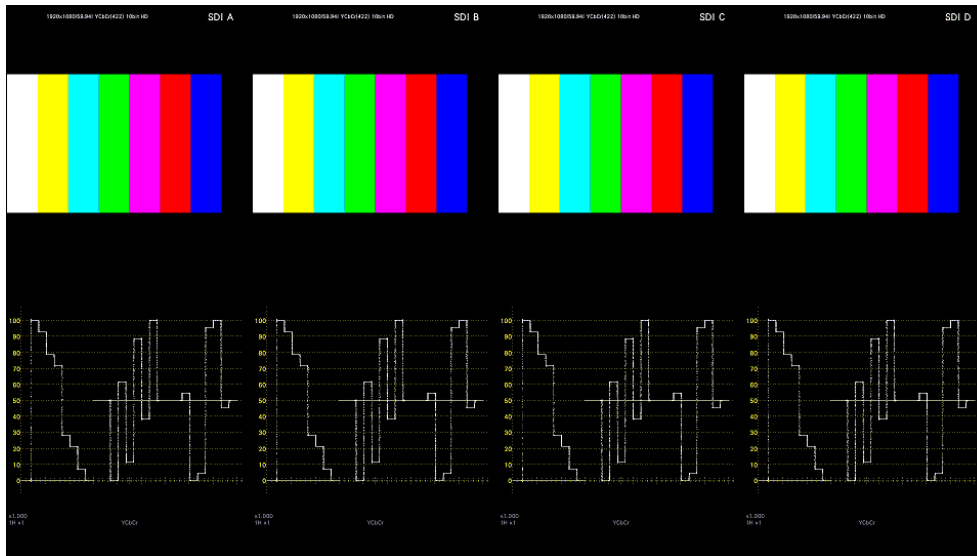

Figure 6-53 Multi display (USER 5, Simul Mode)

- USER 6

The tally, picture, and video signal waveform are displayed in tiles. This is suitable for simul mode.

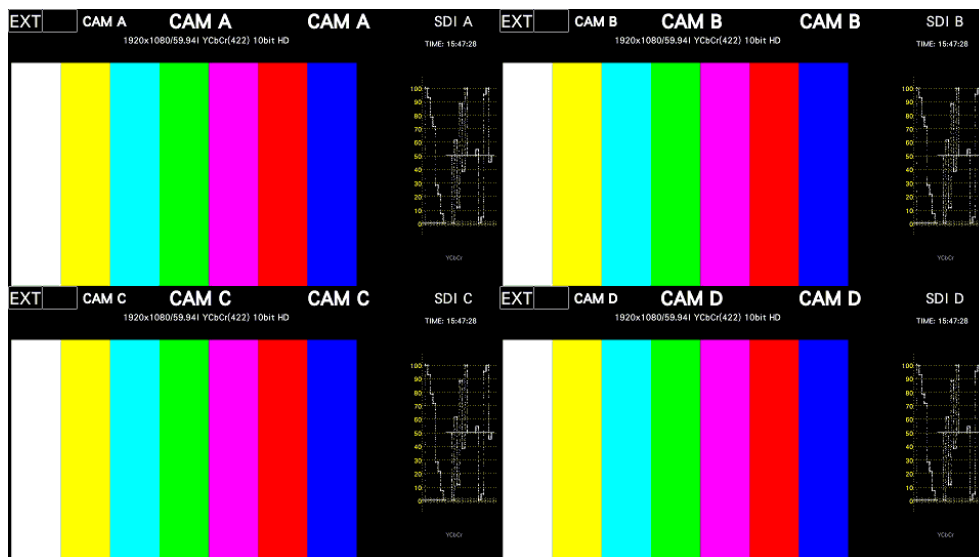

Figure 6-54 Multi display (USER 6, Simul Mode)

6.4 Operation Key Actions

Operation keys are shortcut keys for functions that are frequently used in video content production. Key assignments can be changed freely on the OPERATION KEY tab.

[See also] OPERATION KEY tab → 7.2.15, "Setting the Operation keys"

- LV5600

The S-CUT key can be controlled from the panel, mouse, and touch panel. Others can be controlled from the mouse and touch panel.

- LV7600

Keys can be controlled from the panel, mouse, and touch panel.

LV5600

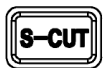

LV7600

Figure 6-55 Operation keys (panel)



Figure 6-56 Operation keys (mouse and touch panel control screen)

6. BASIC OPERATION

- S-CUT Key

Performs the action selected with SHORT CUT on the OPERATION KEY tab.

Table 6-1 SHORTCUT key action

DIRECT	The previously registered panel settings will be loaded. To register the panel settings, configure the instrument to the settings that you want to register, press MEM, and then press SHORTCUT.
CAP&WAIT	A screen capture will be taken and saved to a USB memory device. Connect a USB memory device in advance.
INTEN	Use the function menu shown in the lower right of the screen to adjust the waveform intensity. This is valid on the video signal waveform display, vector display, and audio display (SER03). When a mouse is connected, clicking the function menu resets the value to the default. When using the touch panel, tapping the function menu resets the value to the default.
CURSOR	Performs cursor measurement. This is valid on the video signal waveform display and vector display.
VOLUME	Use the function menu shown in the lower right of the screen to adjust the headphone volume. When a mouse is connected, clicking the function menu resets the value to the default. When using the touch panel, tapping the function menu resets the value to the default.

- Operation Keys Other Than S-CUT

This is valid on the video signal waveform display and vector display. Each time you press the key, the settings assigned to the key switch.

[See also] Video signal waveform display → 10.1, "Operation Key Description"

Vector display → 11.1, "Operation Key Description"

6. BASIC OPERATION

6.5 Customized Layout (SER26)

The layout of the measurement screen that appears when the WFM, VECT, PIC, AUDIO, STATUS, or EYE key is pressed (one type each) and the screen that appears when the MULTI key is pressed (six types) can be arranged freely. To do so, connect a mouse to the front panel USB port or use the touch panel.

The layout that you specify will not be initialized even if you initialize the instrument. To initialize, perform any of the procedures below.

[See also] 7.7, "Initialization"

LAYOUT INITIALIZE YES on the SYS menu:	The entire layout is initialized.
ALL INITIALIZE YES on the SYS menu:	The entire layout is initialized.
Factory default settings:	The entire layout is initialized.
DEFAULT LAYOUT in the layout window	The layout of the selected measurement display is initialized.

6.5.1 Notes

The maximum number of items that can be arranged is determined by $128 \div$ the number of display channels (1 to 4).

Item, here, includes the items on the Main and Sub tabs as well as Format, Input, and Time on the Option tab.

6. BASIC OPERATION

6.5.2 Layout Procedure

As an example, this section explains how to change the layout of a multi display (User 1) in the following manner.

- Display the layout screen
- Change TIME in the upper right of the screen to DATE
- Superimpose the vector on the picture
- Add audio
- Add TIME to the status
- Apply the changes

Before change

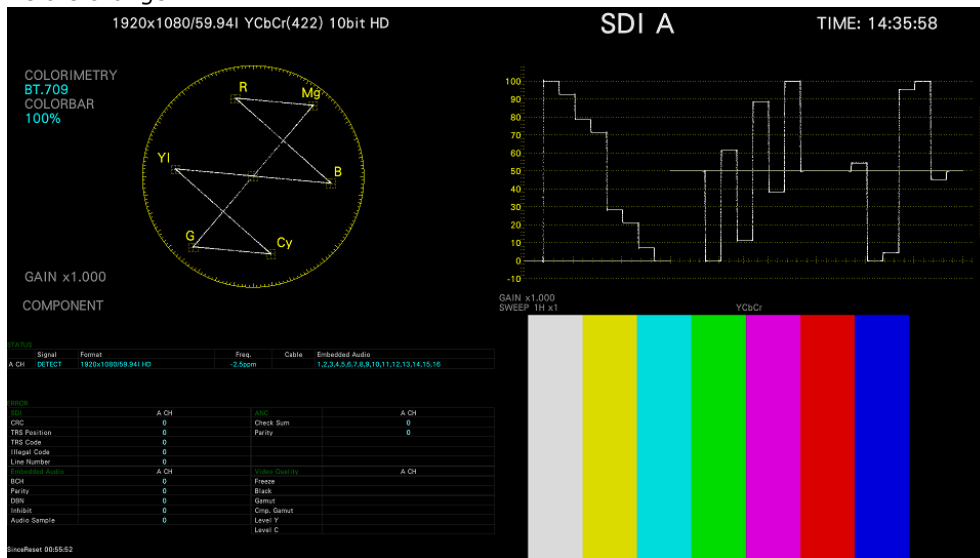

After change

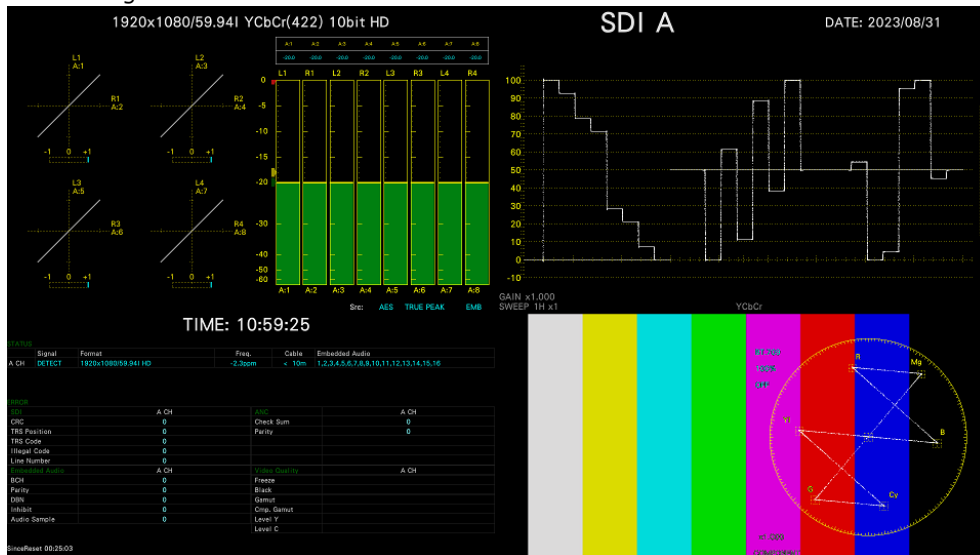

Figure 6-57 Arranging the multi display layout

6. BASIC OPERATION

a) Display the layout screen

1. Press MULTI, and set **F•1** LAYOUT SELECT to USER 1.

If Mode Key Direct on the GENERAL tab is set to Multi/Single Common, hold MULTI down for about 2 seconds to display the function menu.

There are six layouts for the multi screen. You can use USER 1 to USER 6 to switch between the layouts.

2. Right-click on the measurement screen or click or tap RIGHT CLICK at the upper left of the screen to select LAYOUT.

The layout screen appears.

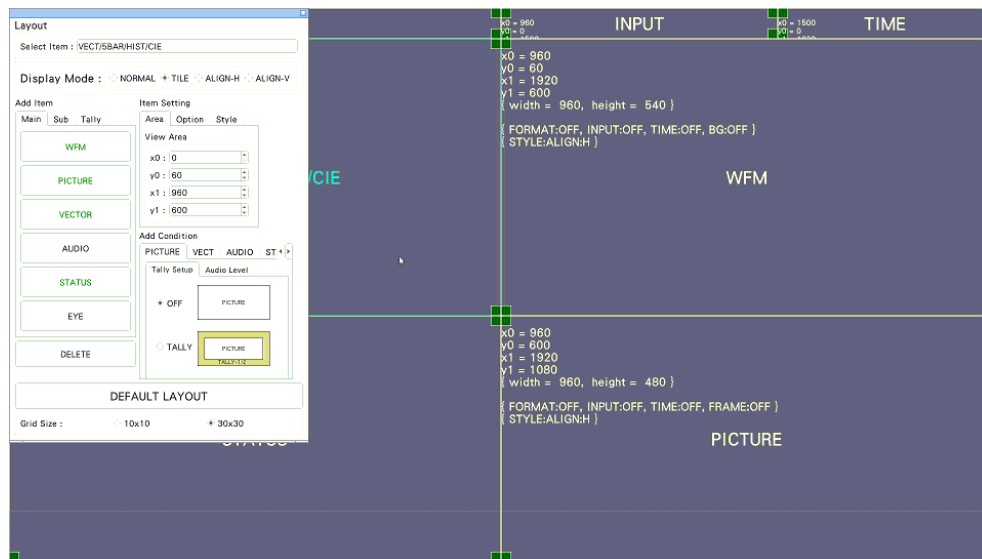

Figure 6-58 Layout screen

b) Change TIME in the upper right of the screen to DATE

3. Click or tap the TIME item in the upper right of the screen.

The color of the frame and text changes to light blue, and Select Item in the layout window displays TIME. This indicates that the TIME item is selected.

4. Click or tap DELETE.

The TIME item is deleted.

5. On the Sub tab, click or tap DATE.

The DATE item appears.

6. BASIC OPERATION

6. Place the DATE item in the area where the TIME item was displayed.

To move an item, drag it.

To resize an item, drag the green handles at the four corners of the item.

The position and size of an item snap to the grid selected by Grid Size in the layout window.

You can also use the Area tab to move and resize an item.

The coordinates at the upper left corner of the screen are (0, 0). Those at the lower right corner are (1920, 1080). Using these references, set the coordinates of the upper left corner of the item (x0, y0) and the lower right corner (x1, y1).

The minimum size is 90×60.

If the layout window gets in the way, move it or close it. When using a mouse, to display a window that you closed, double-click in the layout screen.

If multiple items are on top of each other, items in the back may not be selectable. If you need to select such item, click or tap the item on the Main or Sub tab. The selected item will move to the front.

c) Superimpose the vector on the picture

7. Select the VECTOR item, and click Background Transparent on the Option tab.

Background Transparent is for making the background transparent when an item is superimposed on a picture.

8. Place the VECTOR item on top of the picture.

Resize as necessary.

d) Add audio

9. On the Main tab, click or tap AUDIO.

The AUDIO item appears.

10. Place the AUDIO item in the area where the VECTOR item was originally displayed.

e) Add TIME to the status

11. Click or tap the STATUS item.

12. On the Option tab, click or tap Time.

The TIME item on the Sub tab can be placed anywhere. Time on the Option tab is displayed at the top of the selected item. You cannot change the display position or size.

f) Apply the changes

13. Right-click or tap in the layout screen, and click or tap SAVE.

The measurement screen returns.

If you click or tap EXIT, all the changes that you made up to that point will be canceled.

6. BASIC OPERATION

6.5.3 Layout Screen Description

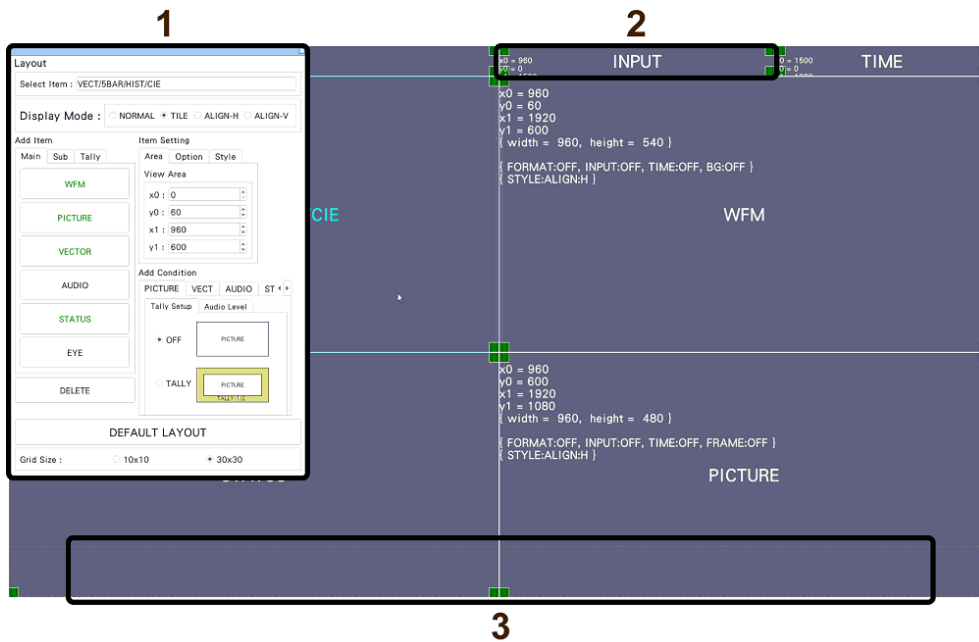



Figure 6-59 Layout screen

1 Layout Window

The Layout window is used to create layouts.

Mode in the title bar displays the current measurement mode (WFM, USER 1 to USER 5, etc.).

You can move the window by dragging and close it by clicking or tapping  in the upper right of the window. When using a mouse, to display a window that you closed, double-click in the layout screen.

2 Item

Displays the item selected on the Main or Sub tab.

The settings specified with Item Setting are displayed in the frame.

If you select it, the frame color changes from white to light blue.

3 Menu Guide

A function menu appears in this area.

Use these as guides when placing items.

6. BASIC OPERATION

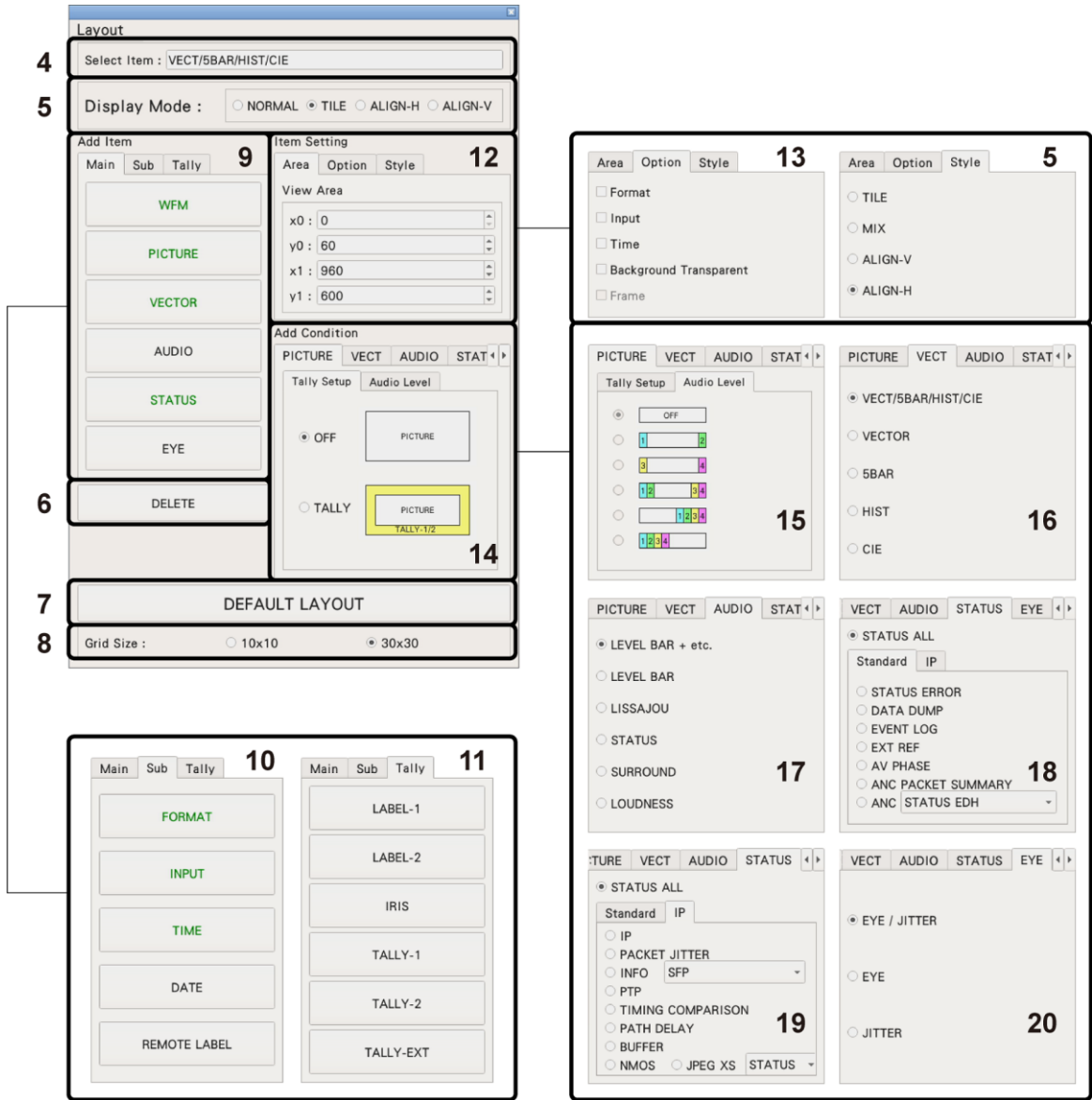

Figure 6-60 Layout window

6. BASIC OPERATION

4 Select Item

Displays the selected item.

5 Display Mode / Style

Select the display format for simul mode.

Display Mode applies to the entire screen, Style applies to the selected item.

If Display Mode is not set to NORMAL or if the selected item is AUDIO or EYE, Style cannot be selected.

If the selected item is VECTOR (5BAR), VECTOR (HIST), VECTOR (CIE), STATUS, or an item on the Sub tab, you cannot set Style to MIX.

If Display Mode is not set to NORMAL and multiple channels are displayed in simul mode, even if you place AUDIO or EYE items in the layout, "Not supported" will appear and will not work.

For example, if the following screens are displayed in single input mode and you change to simul mode, the display changes depending on Display Mode as follows.

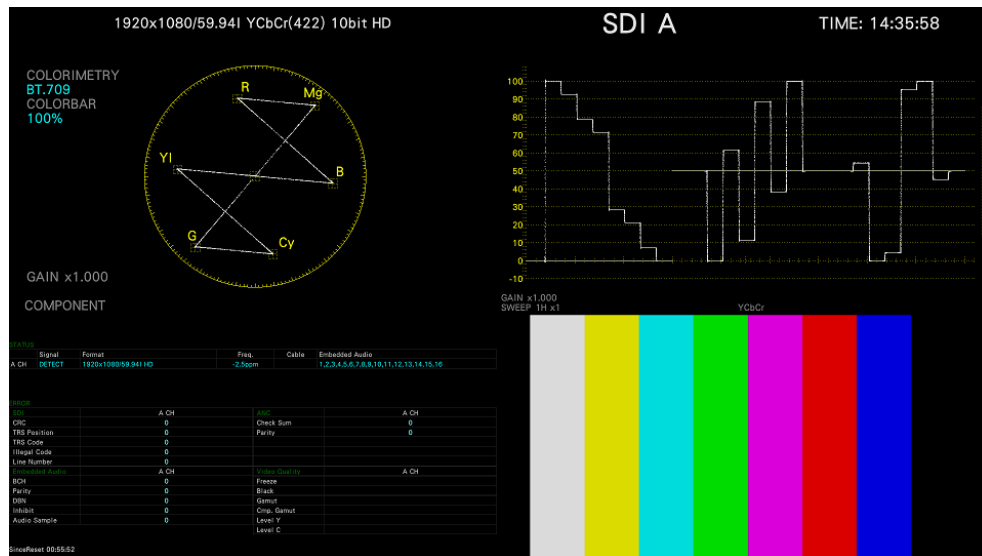

Figure 6-61 Single input mode

6. BASIC OPERATION

- When Display Mode Is NORMAL

The screen is divided by channel within each item. Select the division format with Style.

TILE (tile the screens)

MIX (cascade the screens)

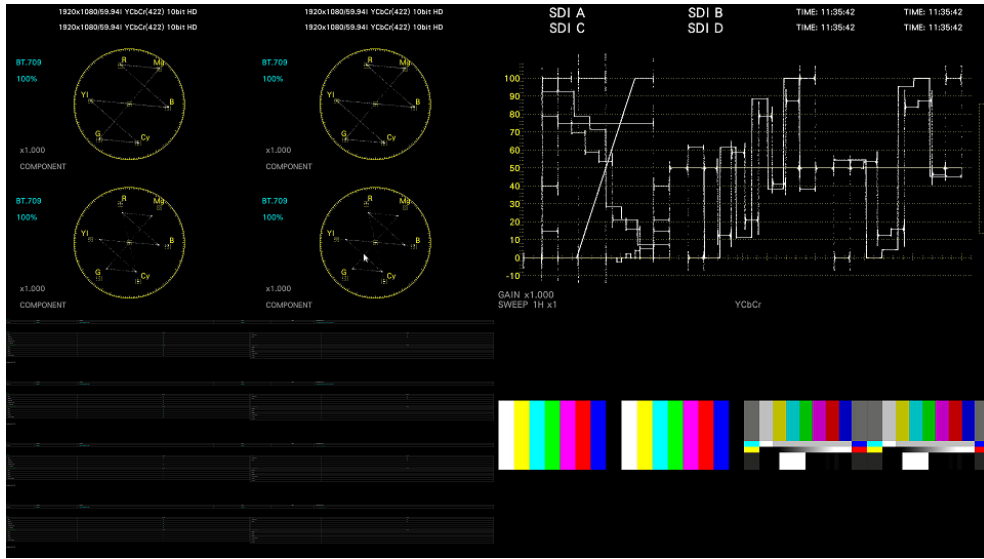

ALIGN-V (arrange vertically)

ALIGN-H (arrange horizontally)

Figure 6-62 Normal display

- When Display Mode Is TILE

The screen is divided by channel.

Ach

Bch

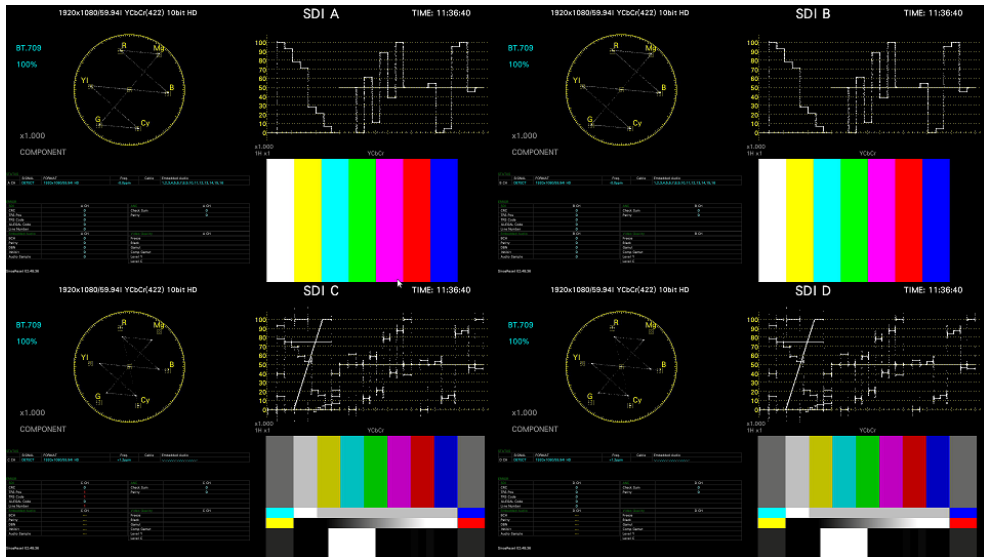

Cch

Dch

Figure 6-63 Tiled display

6. BASIC OPERATION

- When Display Mode Is ALIGN-H

The screen is divided by channel and arranged side by side.

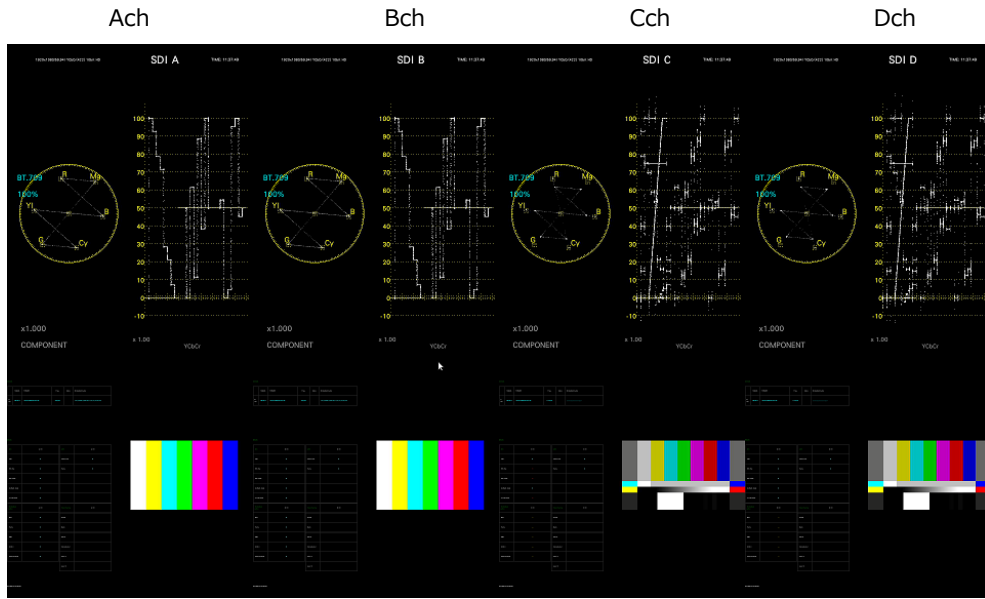

Figure 6-64 ALIGN-H display

- When Display Mode Is ALIGN-V

The screen is divided by channel and arranged top to bottom.

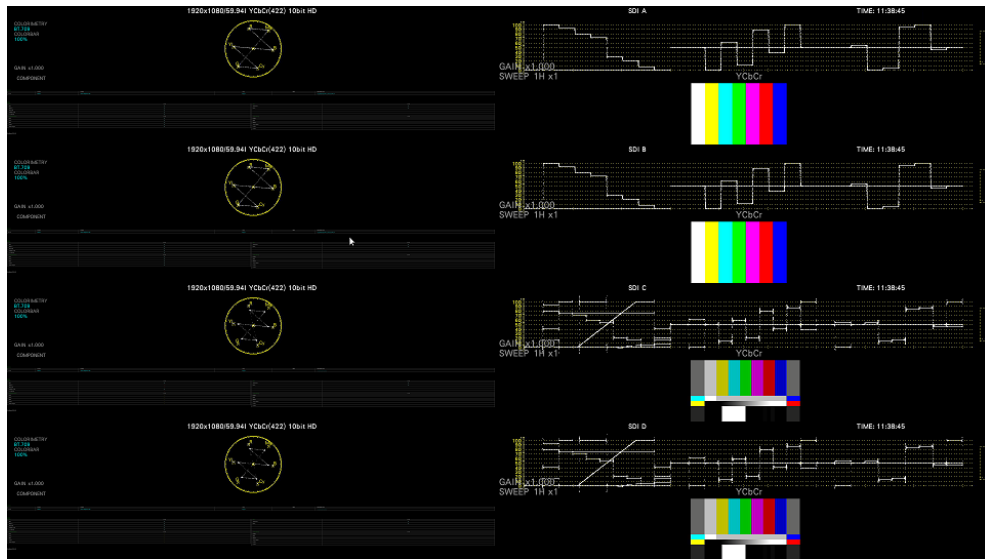

Figure 6-65 ALIGN-V display

6. BASIC OPERATION

6 DELETE

Deletes the selected item.

7 DEFAULT LAYOUT

Resets the layout to the initial settings defined for each measurement mode. Grid Size is not reset.

8 Grid Size: 10x10 / 30x30

Select the grid size.

The position and size of items snap to the grid specified here.

9 Main

Measurement items.

- WFM

Shows the video signal waveform display.

- PIC

Shows the picture display.

- VECTOR

Click or tap this after selecting the display mode on the VECTOR tab to show the vector waveform. A CIE chromaticity diagram will not be displayed properly if the VECT item is overlapping other items.

- AUDIO

Click or tap this after selecting the display mode on the AUDIO tab to show audio. If SER03 is not installed, the message "Not installed" is displayed.

- STATUS

Click or tap this after selecting the display mode on the STATUS tab to show the status.

- EYE

Click or tap this after selecting the display mode on the EYE tab to show the eye pattern or jitter.

If SER02/SER02A is not installed, the message "Not installed" is displayed.

6. BASIC OPERATION

10 Sub

Items for displaying information.

- **FORMAT**

Shows the format (e.g., 1920x1080/59.94I YCbCr(422) 10bit HD).

If you place this item, you can show and hide it using the CAPTURE&DISPLAY tab of the SYS menu.

It is normally displayed in white, but if the input format is not appropriate, it turns red.

- **INPUT**

Shows the input signal (e.g., SDI A).

If you place this item, you can show and hide it using the CAPTURE&DISPLAY tab of the SYS menu.

- **TIME**

Shows the time (e.g., TIME: 00:00:00).

If you place this item, you can select the display format using the CAPTURE&DISPLAY tab of the SYS menu. You can also display source ID and timecode information.

- **DATE**

Shows the date (e.g., DATE: 2000/01/01).

If you place this item, you can select the display format using the CAPTURE&DISPLAY tab of the SYS menu.

Only one item is displayed even if you switch to simul mode.

11 Tally

Items for tally display and camera ID display.

Unarranged items are displayed with black characters. Clicking an item places the item.

Arranged items are displayed with green characters. Clicking an item selects the item.

- **LABEL-1, LABEL-2**

Shows the camera ID set on the RS485 tab, CAMERA ID tab or through RS-422/485.

The default values are CAM A to CAM D and vary depending on the channel.

[See also] RS485 tab → 7.2.12, "Configuring the RS-422/485 Settings (SER27)"

CAMERA ID tab → 7.2.13, "Setting the Camera ID (SER27)"

- **IRIS**

Shows the iris set on the RS485 tab, CAMERA ID tab or through RS-422/485.

The default values are CAM A to CAM D and vary depending on the channel.

[See also] RS485 tab → 7.2.12, "Configuring the RS-422/485 Settings (SER27)"

CAMERA ID tab → 7.2.13, "Setting the Camera ID (SER27)"

- **TALLY-1, TALLY-2, TALLY-EXT**

Shows the tally set through the remote connector, TALLY tab or RS-422/485.

TALLY-EXT (EXTENDED) is a tally display with a comment of up to eight characters. You can edit the comment on the REMOTE tab.

[See also] TALLY tab → 7.2.14, "Configuring the Tally Display (SER27)"

REMOTE tab → 7.2.8, "Setting the Remote Connector"

6. BASIC OPERATION

12 Area

Set the position and size of the selected item.

The coordinates at the upper left corner of the screen are (0, 0). Those at the lower right corner are (1920, 1080). Based on these references, the coordinates of the upper left corner of the item is (x0, y0), and those of the lower right corner is (x1, y1).

You can change the values using the ▲▼ key or the wheel on the mouse.

13 Option

Set the options for the selected item.

- Format

Turns on and off the format display (e.g., 1920x1080/59.94I YCbCr(422) 10bit HD).

This option cannot be displayed for an AUDIO item, EYE item, or an item on the Sub tab.

If this is set to on, you can show and hide it using the CAPTURE&DISPLAY tab of the SYS menu.

It is normally displayed in white, but if the input format is not appropriate, it turns red.

- Input

Turns on and off the input signal display (e.g., SDI A).

This option cannot be displayed for an AUDIO item, EYE item, or an item on the Sub tab.

If this is set to on, you can show and hide it using the CAPTURE&DISPLAY tab of the SYS menu.

- Time

Turns on and off the time display (e.g., TIME: 00:00:00).

This option cannot be displayed for an AUDIO item, EYE item, or an item on the Sub tab.

If this is set to on, you can select the display format using the CAPTURE&DISPLAY tab of the SYS menu. You can also display source ID and timecode information.

- Background Transparent

Selects the transmittance of the background when the sub item is superimposed on a picture.

When enabled, the transmittance is set to 100 %; when disabled, the transmittance is set to 50 %.

You cannot set this option for a PIC item.

- Frame

Turns on and off the frame display of PICTURE items.

6. BASIC OPERATION

14 PICTURE - Tally Setup

Select whether to display tallies on the outer frame of the PICTURE item.
This setting applies to all PICTURE items and enhanced layout.

If this is set to on, TALLY-1 set through the remote connector, TALLY tab or RS-422/485 is shown on the outside and TALLY-2 on the inside. Tally is not displayed when the input signal is 3G-B DS.

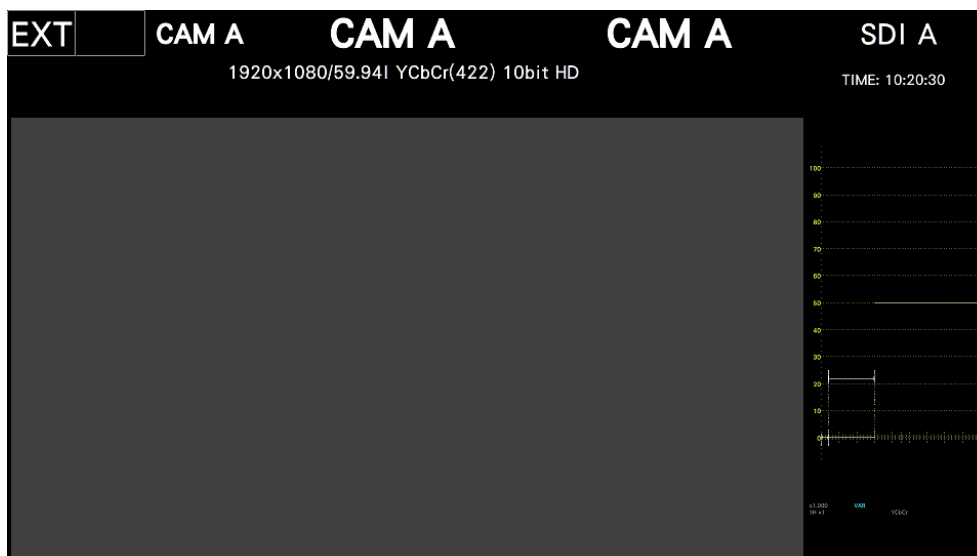

Figure 6-66 Tally display

15 PICTURE - Audio Level

Select whether to display audio meters on both sides of the PICTURE item.
This setting applies to all PICTURE items.

When SER03 is not installed, only 2-channel display can be selected.

If the AUDIO item is also displayed simultaneously or if the input signal is 3G-B DS, audio meters are not displayed.



Figure 6-67 Audio meter display

6. BASIC OPERATION

16 VECT

Select the display mode of the VECTOR item. Select the mode before clicking or tapping the VECTOR item.

VECT / 5BAR / HIST / CIE (*1)	Shows the normal vector display. You can switch the display between vector waveform, 5bar, histogram and CIE chromaticity diagram. It cannot be arranged with the items below at the same time. If you want to arrange the items below, delete this item first.
VECTOR	Shows vectors.
5BAR	Switches to the 5-bar display.
HIST	A histogram is displayed.
CIE	The CIE chromaticity diagram display is shown.

17 AUDIO

Select the display mode of the AUDIO item. Select the mode before clicking or tapping the AUDIO item.

LEVEL BAR + etc. (*1)	This is the normal audio display. The display switches between Lissajous, surround, meter, status, and loudness. It cannot be arranged with the items below at the same time. If you want to arrange the items below, delete this item first.
LEVEL BAR	Meters are displayed. It cannot be arranged with LOUDNESS at the same time. When 16 channels are being measured, meters will not be displayed correctly if arranged at the same time with SURROUND.
LISSAJOU	Lissajous curves are displayed.
STATUS	Shows the status.
SURROUND	Surround waveforms are displayed. This item will not be displayed correctly when 16 channels are being measured or when embedded audio is being measured.
LOUDNESS	Loudness are displayed It cannot be arranged with LEVEL BAR at the same time. This item will not be displayed correctly when 16 channels are being measured or when embedded audio is being measured.

6. BASIC OPERATION

18 STATUS - Standard

Selects the display mode of the STATUS item. Select the mode before clicking or tapping the STATUS item.

STATUS ALL (*1)	This is the normal status display. The display switches between error count, data dump, IP, etc. It cannot be arranged with the items below at the same time. If you want to arrange the items below, delete this item first.
STATUS ERROR	Error counts are displayed.
DATA DUMP	Data dump is displayed.
EVENT LOG	The event log is displayed.
EXT REF	Phase differences are displayed.
AV PHASE	Lip sync is displayed.
ANC PACKET SUMMARY	A summary of ancillary pockets is displayed.
ANC	One of the following is displayed. <ul style="list-style-type: none"> • STATUS EDH: EDH Display • STATUS PAYLOAD: Payload ID Display • STATUS CONTROL: Audio control packet display • STATUS ARIB CC: Closed Caption Display • STATUS ARIB NETQ: NET-Q display • STATUS ARIB TRIG: Data trigger display • STATUS ARIB USER1: User data 1 display • STATUS ARIB USER2: User data 2 display • STATUS SMPTE SR Live: SR Live display • STATUS SMPTE 608: EIA-608 data display • STATUS SMPTE 708: EIA-708 data display • STATUS SMPTE AFD: AFD Display • STATUS SMPTE PROG: Program data display • STATUS SMPTE VBI: VBI data display • STATUS SMPTE SCTE104: SCTE-104 display • STATUS SEARCH: Ancillary packet search display

6. BASIC OPERATION

6.6 Enhanced Layout (SER26)

Enhanced layout is an extended function that enables the measurement screens of up to four channels to be laid out on a single screen simultaneously in simul mode. To use this function, connect a mouse to the front panel USB port.

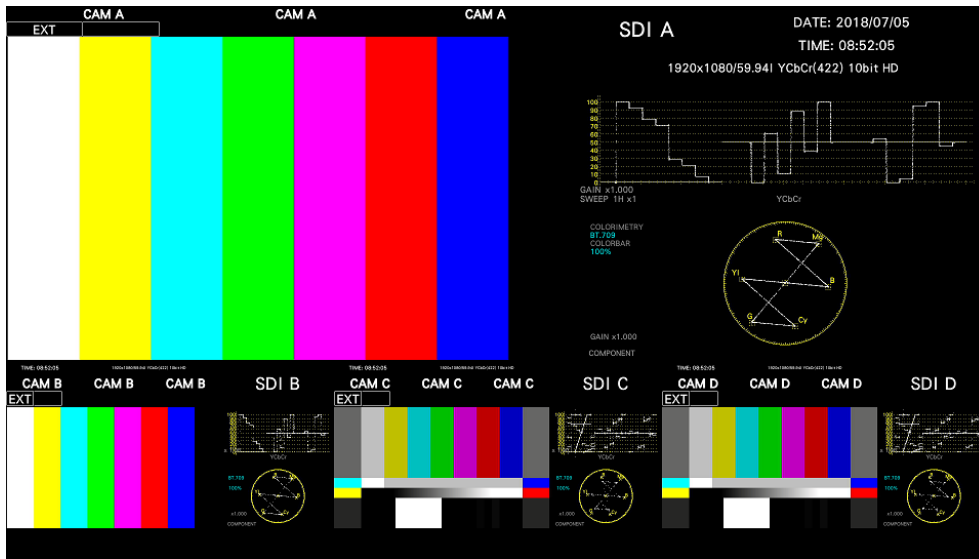

Figure 6-69 Enhanced layout

Enhanced layout will not be initialized even if PARAM INIT YES is executed from the SYS menu. To initialize it, execute LAYOUT INIT YES or ALL INIT YES from the SYS menu, factory default initialization, or DEFAULT LAYOUT from the enhanced layout window.

[See also] 7.7, "Initialization"

As shown below, the number of layout channels differs between the enhanced layout and customized layout.

[See also] 6.5, "Customized Layout (SER26)"

Table 6-2 Layout comparison

	Enhanced layout	Customized layout
Number of layout channels	1 to 4	1

6. BASIC OPERATION

6.6.1 Enhanced Layout Procedure

As an example, this section will explain the procedure to display the enhanced layout of channels A to D.

Enhanced layout can be shown in simul mode when multi-screen display is in use.

1. On the SDI IN SETUP1 tab of the SYS menu, set SDI System to 2K SD/HD/3G-A/3G-B-DL.

SYS → F•1 SIGNAL IN OUT → F•2 PREV TAB or F•3 NEXT TAB →

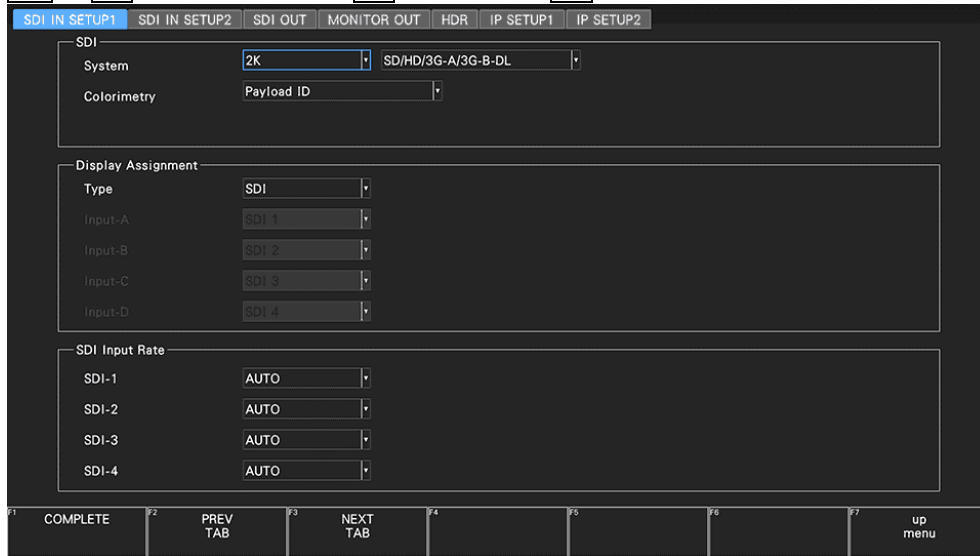

Figure 6-70 SDI IN SETUP1 tab

2. Set F•7 DISPLAY of the INPUT menu to SIMUL, and set F•1 A to F•4 D to ON.

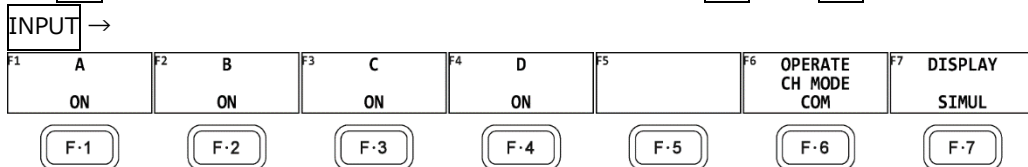

Figure 6-71 INPUT menu

3. Press MULTI.

6. BASIC OPERATION

- Right-click in the measurement screen, and click ENHANCED LAYOUT.

The enhanced layout screen appears.

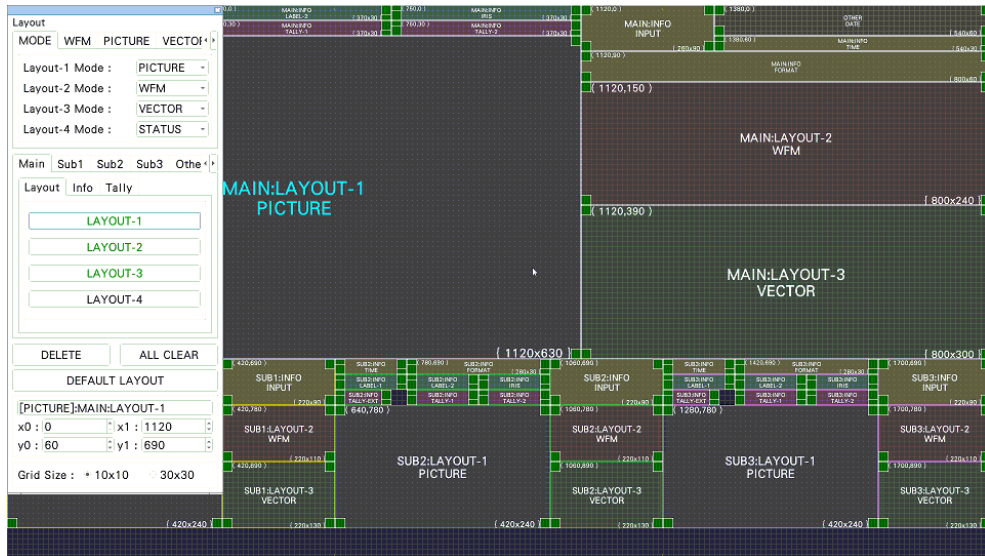

Figure 6-72 Enhanced layout screen

- Change the layout as necessary.

A default layout is initially stored in the main unit. Even after you change the layout, you can return to the default layout by clicking DEFAULT LAYOUT.

To create a new layout after clearing the default layout, click ALL CLEAR.

The basic operation is the same as with the customized layout. See section 6.5.2, "Layout Procedure."

For details on the enhanced layout screen, see section 6.6.2, "Enhanced Layout Screen Description."

- Selecting the Measurement Mode

You can select up to four measurement modes. Assign measurement modes to Layout-1 to Layout-4.

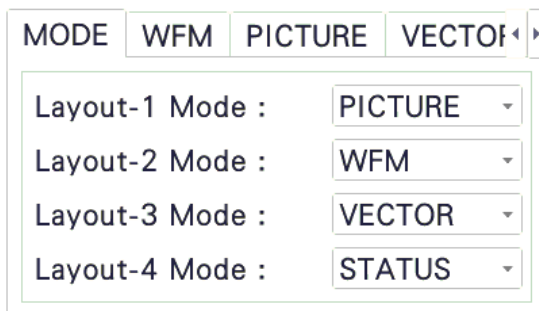

6. BASIC OPERATION

- Arranging Items

Arrange items on the Main, Sub1, Sub2, Sub3, and Other tabs.

Main, Sub1, Sub2, and Sub3 represent four channels. The channel selected with **F•6** INPUT SELECT on each measurement screen is displayed in Main.

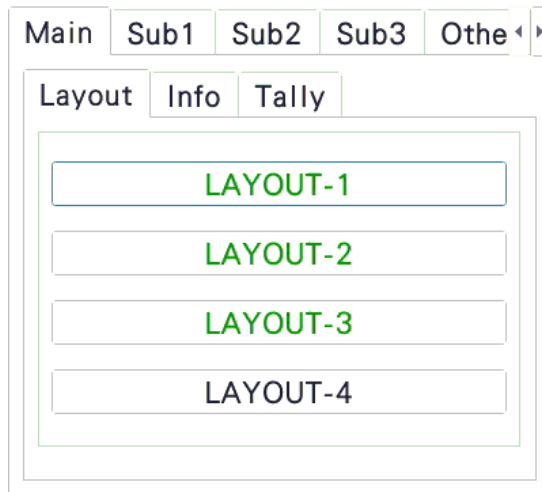

- Notes

- Arrange PICTURE items so they do not overlap.
- Arrange waveform display items (WFM, VECTOR) so they do not overlap.
- Arrange Main, Sub1, Sub2, and Sub3 according to the number of channels to be used with the following combinations. Arrangements other than these combinations are possible, but they will not be displayed correctly.

Number of channels	Main	Sub1	Sub2	Sub3
1	✓	-	-	-
2	✓	✓	-	-
3	✓	✓	✓	-
4	✓	✓	✓	✓

6. BASIC OPERATION

- Right-click or tap in the enhanced layout screen, and click or tap SAVE.

The measurement screen returns.

If you click or tap EXIT, all the changes that you made up to that point will be canceled.

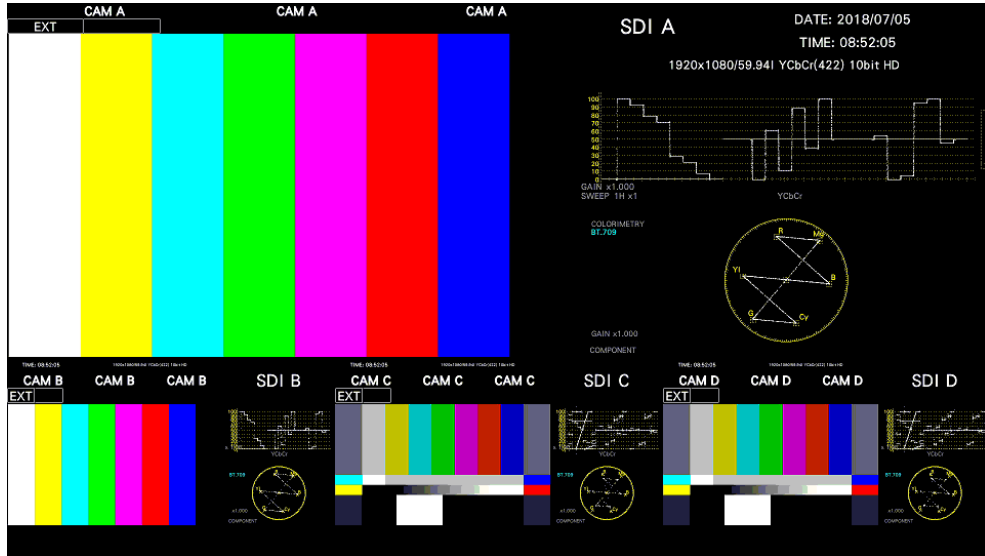

Figure 6-73 Enhanced layout (INPUT SELECT = A)

Items arranged on Main show the channels selected with **F.6** INPUT SELECT on each measurement screen. However, if you click a picture of Sub1, Sub2, or Sub3, the channel that you click appears on Main.

For example, in the above figure, if you click the picture of Sub2 (Cch), Cch appears on Main. (Sub1 to Sub3 show channels other than the channel shown on Main in the A, B, C, D order.)

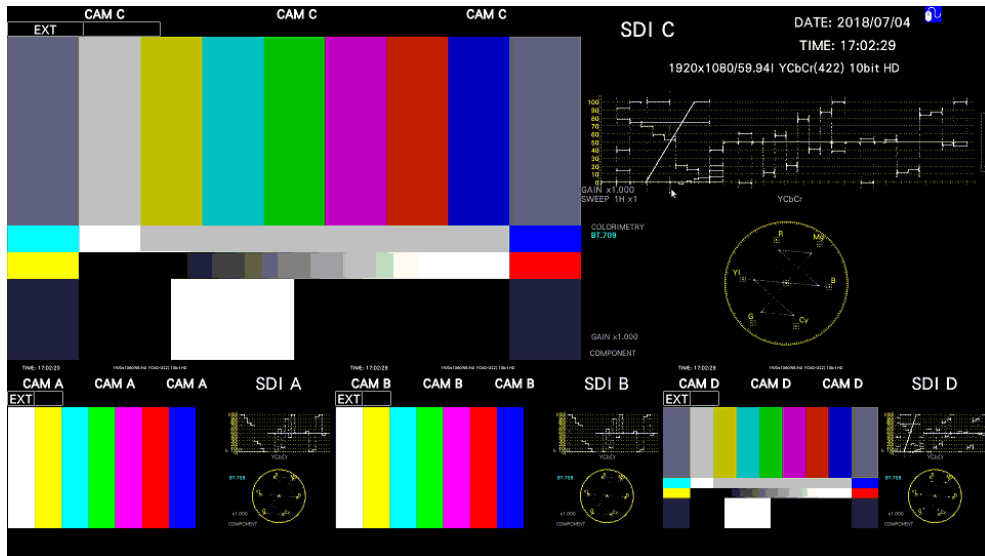

Figure 6-74 Enhanced layout (INPUT SELECT = C)

6. BASIC OPERATION

6.6.2 Enhanced Layout Screen Description

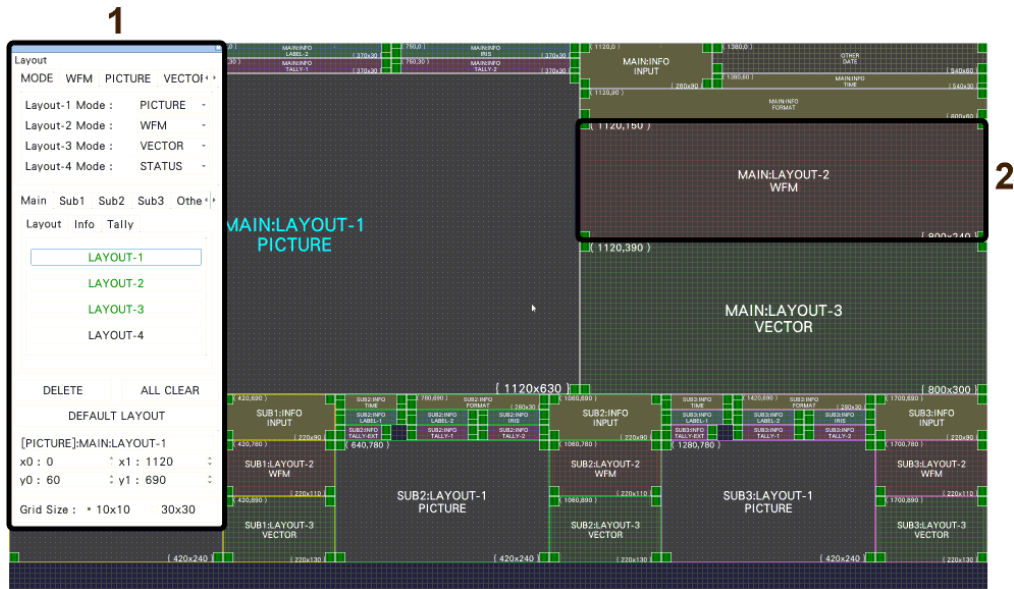

Figure 6-75 Enhanced layout screen description

1 Enhanced layout window

The Layout window is used to create layouts.

You can move the window by dragging and close it by clicking in the upper right of the window. If you close it, you can redisplay it by double-clicking in the enhanced layout screen.

6. BASIC OPERATION

2 Item

Items arranged on the Main, Sub1 to Sub3, and other tabs are displayed. The upper-left coordinate, item name, and size are displayed in the frame. If you select it, the item name color changes from white to light blue.

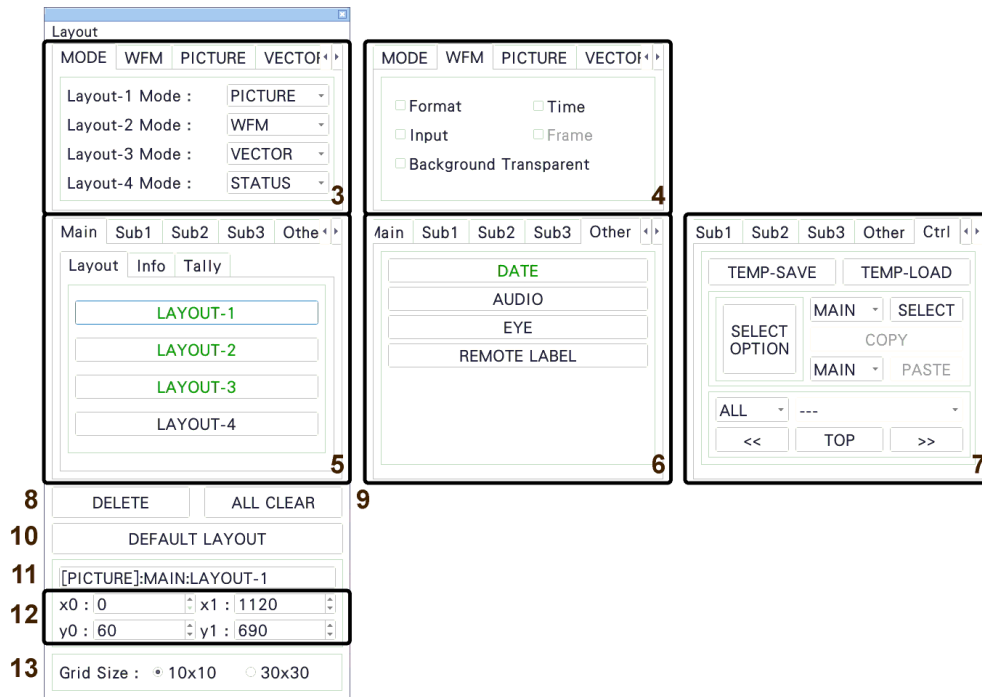

Figure 6-76 Enhanced layout window

3 MODE

Assign measurement modes to Layout-1 to Layout-4. You can select from the following measurement modes.

WFM / VECTOR / PICTURE / STATUS

4 WFM / PICTURE / VECTOR / AUDIO / STATUS / EYE

Set the options for each measurement mode.

You can set these items when you arrange an item.

- Format

Turns on and off the format display (e.g., 1920x1080/59.94I YCbCr(422) 10bit HD).

If you set this to ON, you can show and hide it using the CAPTURE&DISPLAY tab of the SYS menu.

It is normally displayed in white, but if the input format is not appropriate, it turns red. If the specified format is not received, it turns yellow.

- Time

Turns on and off the time display (e.g., TIME: 00:00:00).

If you set this option to ON, you can select the display format using the CAPTURE&DISPLAY tab of the SYS menu. You can also display source ID and timecode information.

6. BASIC OPERATION

- **Input**
Turns on and off the input signal display (e.g., SDI A).
If you set this to ON, you can show and hide it using the CAPTURE&DISPLAY tab of the SYS menu.
 - **Frame**
Turns on and off the frame display of PICTURE items.
 - **Background Transparent**
Selects the transmittance of the background when the sub item is superimposed on a picture.
When enabled, the transmittance is set to 100 %; when disabled, the transmittance is set to 50 %.
You cannot set this option for a PICTURE item.
 - **Tally Setup**
Select whether to display tallies on the outer frame of the PICTURE item.
See "14 PICTURE - Tally Setup" in section 6.5.3, "Layout Screen."
 - **Audio Level**
Select whether to display audio meters on both sides of the PICTURE item.
See "15 PICTURE - Audio Level" in section 6.5.3, "Layout Screen."
- 5 **Main / Sub1 / Sub2 / Sub3**
- Main, Sub1, Sub2, and Sub3 represent four channels. For each channel, you arrange items. (To arrange items for three channels, use the Main, Sub1, Sub2 combination. For two channels, use the Main, Sub1 combination. For one channel, use Main.)
- Main displays the channel selected with **F•6** INPUT SELECT on each measurement screen.
- Sub1 to Sub3 show channels other than the channel shown on Main in the A, B, C, D order.
- Items are categorized into Layout, Info, and Tally.
Unarranged items are displayed with black characters. Clicking an item places the item.
Arranged items are displayed with green characters. Clicking an item selects the item.

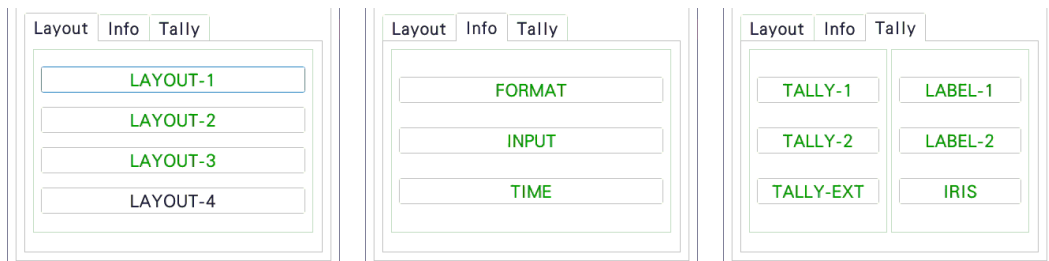

- **LAYOUT-1 to LAYOUT-4**
Shows the measurement mode assigned on the MODE tab.

6. BASIC OPERATION

- **FORMAT**

Shows the format (e.g., 1920x1080/59.94I YCbCr(422) 10bit HD).
If you place this item, you can show and hide it using the CAPTURE&DISPLAY tab of the SYS menu.
It is normally displayed in white, but if the input format is not appropriate, it turns red.
If the specified format is not received, it turns yellow.
 - **INPUT**

Shows the input signal (e.g., SDI A).
If you place this item, you can show and hide it using the CAPTURE&DISPLAY tab of the SYS menu.
 - **TIME**

Shows the time (e.g., TIME: 00:00:00).
If you place this item, you can select the display format using the CAPTURE&DISPLAY tab of the SYS menu. You can also display source ID and timecode information.
 - **TALLY-1, TALLY-2, TALLY-EXT**

Shows the tally set through the remote connector, TALLY tab or RS-422/485.
TALLY-EXT (EXTENDED) is a tally display with a comment of up to eight characters. You can edit the comment on the REMOTE tab.
[See also] TALLY tab → 7.2.14, "Configuring the Tally Display (SER27)"
REMOTE tab → 7.2.8, "Setting the Remote Connector"
 - **LABEL-1, LABEL-2**

Shows the camera ID set on the RS485 tab, CAMERA ID tab or through RS-422/485.
The default values are CAM A to CAM D and vary depending on the channel.
[See also] RS485 tab → 7.2.12, "Configuring the RS-422/485 Settings (SER27)"
CAMERA ID tab → 7.2.13, "Setting the Camera ID (SER27)"
 - **IRIS**

Shows the iris set on the RS485 tab, CAMERA ID tab or through RS-422/485.
The default values are CAM A to CAM D and vary depending on the channel.
[See also] RS485 tab → 7.2.12, "Configuring the RS-422/485 Settings (SER27)"
CAMERA ID tab → 7.2.13, "Setting the Camera ID (SER27)"
- 6 Other
- **DATE**

Place the DATE item.
The DATE item shows the date (e.g., DATE: 2000/01/01).
If you place this item, you can select the display format using the CAPTURE&DISPLAY tab of the SYS menu.
 - **AUDIO**

Place the AUDIO item.
 - **EYE**

Place the EYE item.

6. BASIC OPERATION

7 Ctrl

Manipulates items such as select, copy, and paste.

- TEMP-SAVE

Temporarily saves the current layout.

Note that the layout that is present when you enter the enhanced layout screen is automatically saved even if you don't click TEMP-SAVE.

The saved layout is deleted when you exit from the enhanced layout screen.

- TEMP-LOAD

Loads the layout saved with TEMP-SAVE or the layout that was present when you entered the enhanced layout screen.

- SELECT OPTION

Selects the target items when you group items with the SELECT function.

SELECT ITEM OPTION

Layout : 1 2 3 4

Information : FORMAT
 INPUT
 TIME

Tally : 1 2 EXT

Tally Label : 1 2 IRIS

CANCEL OK

- MAIN/SUB1/SUB2/SUB3 - SELECT

Selects the items of the selected channels as a group.

If items are not grouped, SELECT is displayed with black characters.

If items are grouped, SELECT is displayed with green characters, and the selected item range is displayed in white. Moving by dragging, COPY, and DELETE can be used on grouped items.

- COPY

Temporarily saves the layout of items grouped with SELECT.

The saved layout is deleted when you exit from the enhanced layout screen or change the SELECT OPTION.

- MAIN/SUB1/SUB2/SUB3 - PASTE

Pastes the layout saved with COPY to the selected channel.

This is useful such as when you want to make Sub1 to Sub3 the same layout.

If there is a same item as the copied item at the paste destination channel, the position and size are overwritten.

6. BASIC OPERATION

- ALL - ---
CH - MAIN/SUB1/SUB2/SUB3
ITEM - LAYOUT-1/LAYOUT-2 and the like
Selects the target items when you select items with << and >>.
If you select ALL, all items of all channels are selected in order.
If you select CH, all items of the selected channel are selected in order.
If you select ITEM, the selected items of all channels are selected in order.
 - <<, >>
Selects the items specified by ALL/CH/ITEM in order. You can select an item by clicking it directly, but this is useful when items are overlapped and you want to select items in the back.
Moving by dragging, COPY, DELETE, and TOP can be used on selected items.
 - TOP
Moves the selected items to the front.
- 8 DELETE
Deletes individually selected or grouped items.
If the Ctrl tab is displayed, individually selected items can only be deleted if they are part of the ALL/CH/ITEM target.
- 9 ALL CLEAR
Deletes all items.
- 10 DEFAULT LAYOUT
Resets the layout to factory default.
- 11 Item name
Displays the selected item name.
- 12 x0, y0, x1, y1
Set the position and size of the selected item.
The coordinates at the upper left corner of the screen are (0, 0). Those at the lower right corner are (1920, 1080). Based on these references, the coordinates of the upper left corner of the item is (x0, y0), and those of the lower right corner is (x1, y1).
You can change the values using the ▲▼ key or the wheel on the mouse.
- 13 Grid Size: 10x10 / 30x30
Select the grid size.
The position and size of items snap to the grid specified here.

7. SYSTEM SETTINGS

The SYS menu can be used to configure the instrument and options. Press SYS, and use the SYS menu.

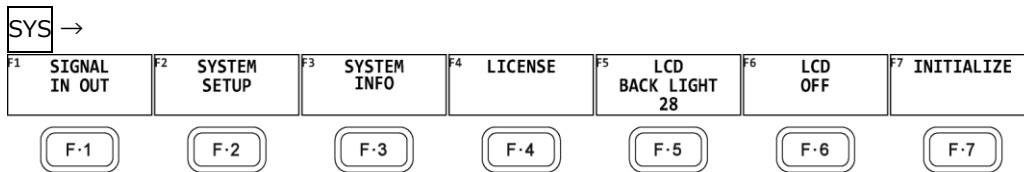

Figure 7-1 SYS menu

7.1 Configuring the I/O Connectors

To configure the I/O connector settings, use **F•1** SIGNAL IN OUT on the SYS menu.

7.1.1 Configuring the Input System

Use SDI on the SDI IN SETUP1 tab to configure the input system of SDI INPUT and IP on the rear panel.

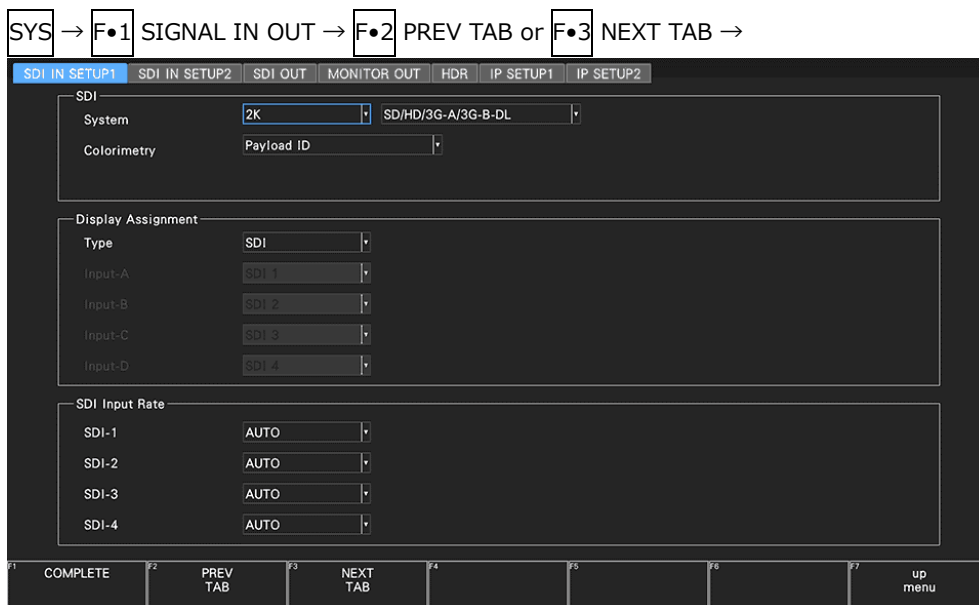

Figure 7-2 SDI IN SETUP1 tab

- System

Select the input format.

4K 12G / 4K 6G / 4K 3G Quad Link / 4K 3G Dual Link / 4K HD Quad Link /
 4K IP Single Stream / 4K IP Quad Stream
 2K SD/HD/3G-A/3G-B-DL(/IP) / 2K HD Dual Link / 2K 3G Dual Link / 2K 3G-B DS

7. SYSTEM SETTINGS

- Colorimetry

Select the colorimetry to use on the video-signal-waveform, vector, picture, and CIE-chromaticity-diagram displays.

The currently applied colorimetry is displayed in cyan in the vector display and CIE chromaticity diagram display. For 3G(QL) and 3G(DL)-4K, if you select a payload ID, the current applied colorimetry is displayed in yellow if the colorimetries of all links are not matched.

For SD input, the colorimetry is fixed to BT.601, regardless of the colorimetry selection.

The picture display on the instrument LCD is not capable of expressing the color gamut of the applied colorimetry.

<u>Payload ID:</u>	The instrument automatically detects the colorimetry from the payload ID and operates. In addition, when the payload ID is an XYZ signal, the instrument operates in DCI mode.
BT-709:	Runs in BT.709 mode.
BT-2020:	Runs in BT.2020 mode.
DCI:	Runs in DCI mode.

- XYZ Gamma Select

Select the gamma correction method for XYZ signal input.

XYZ signals can be converted to RGB signals and displayed as video signal waveforms or vector waveforms, but with 12-bit quantized value (when DCI Gamma is selected) specified in standards, conversion errors will be large near 0% of the input. Therefore, when displaying such as RGB or vector waveforms with SMPTE RP 431 color bar (color patch) code, there are areas where the waveform deviates greatly from the scale.

To reduce this error, the default is set to "Bottom Zero Gamma". This setting is fixed at 0% when the input is from 0% to 0.05%. Select this setting if you want to adjust devices.

<u>Bottom Zero Gamma:</u>	when the input is from 0% to 0.05% gamma is fixed at 0% for DCI gamma.
DCI Gamma:	1/2.6 power of input

7. SYSTEM SETTINGS

Gamma curve (0 to 100% of input)

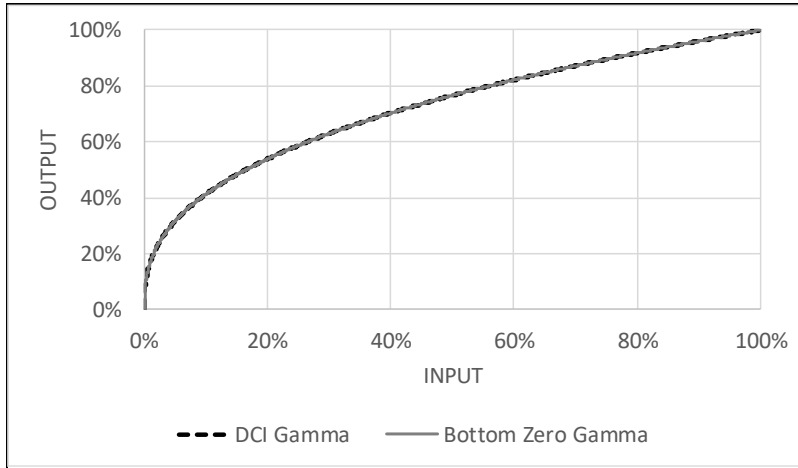

Gamma curve (Expand 0 to 0.2% of input)

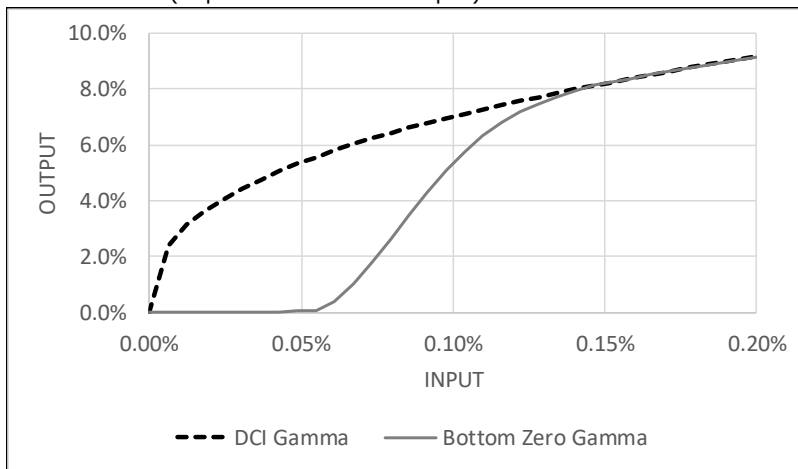

Example of vector waveform display

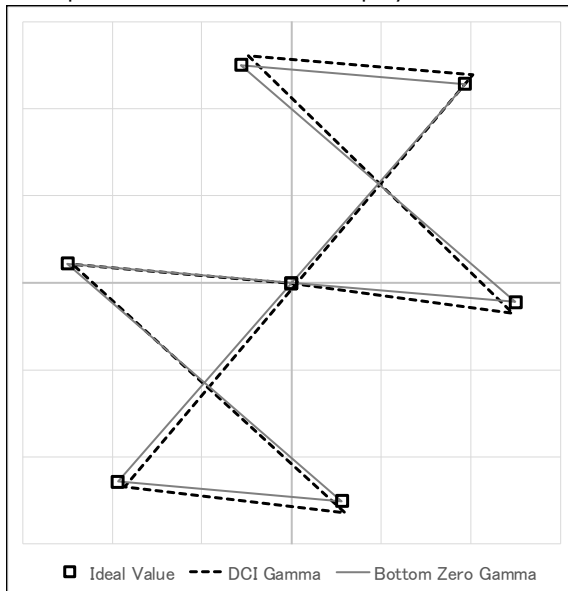

7. SYSTEM SETTINGS

7.1.2 Input Signal Assignment

Use Display Assignment on the SDI IN SETUP1 tab to assign the SDI INPUT and IP connectors on the rear panel to the display channels.

SYS → F•1 SIGNAL IN OUT → F•2 PREV TAB or F•3 NEXT TAB →

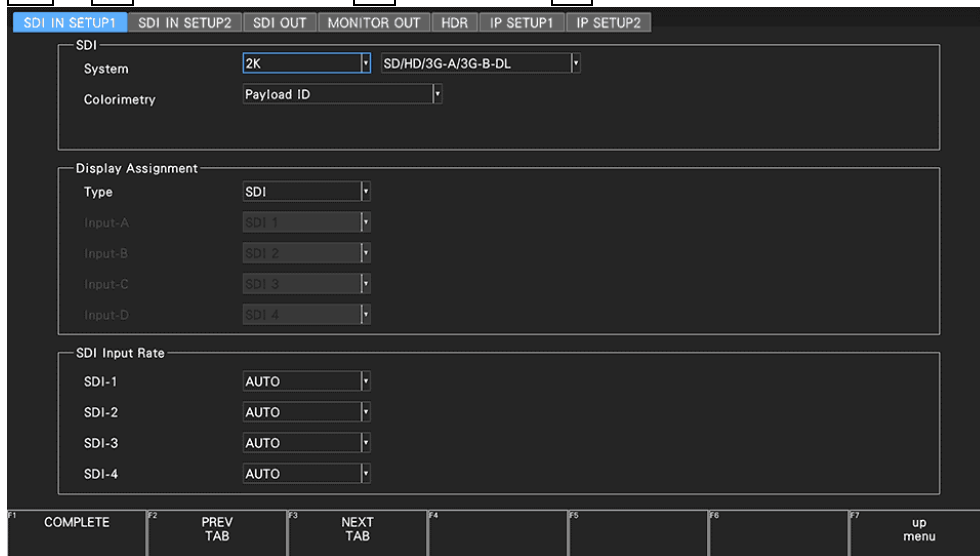

Figure 7-3 SDI IN SETUP1 tab

- Type

Select which signals to apply to the display channels, the SDI signals received through the SDI INPUT connectors or the IP signals received through the IP connectors on the rear panel.

This selection is possible when System is the IP video format and SER26 LAYOUT is not installed. For all other cases, it is fixed to SDI or IP depending on the System setting.

[See also] System →7.1.1, “Configuring the Input System.”

SDI / IP

7. SYSTEM SETTINGS

- Input-A to D (SER26)

When SER26 LAYOUT is installed, the display assignment display is enabled allowing you to assign a single input signal to multiple display channels, regardless of whether the signal is SDI or IP.

You can set these parameters only when SDI System is set to 2K SD/HD/3G-A/3G-B-DL(/IP).

You can select IP Stream when the SER05 10G IP INPUT or SER06 25G IP INPUT is installed. IP Stream3 and IP Stream4 cannot be selected when measuring JPEG XS.

- Input A

Selects the input to display channel A.

SDI 1 / SDI 2 / SDI 3 / SDI 4 /
IP Stream1 / IP Stream2 / IP Stream3 / IP Stream4

- Input B

Selects the input to display channel B.

SDI 1 / SDI 2 / SDI 3 / SDI 4 /
IP Stream1 / IP Stream2 / IP Stream3 / IP Stream4

- Input C

Selects the input to display channel C.

SDI 1 / SDI 2 / SDI 3 / SDI 4 /
IP Stream1 / IP Stream2 / IP Stream3 / IP Stream4

- Input D

Selects the input to display channel D.

SDI 1 / SDI 2 / SDI 3 / SDI 4 /
IP Stream1 / IP Stream2 / IP Stream3 / IP Stream4

When SER26 is installed

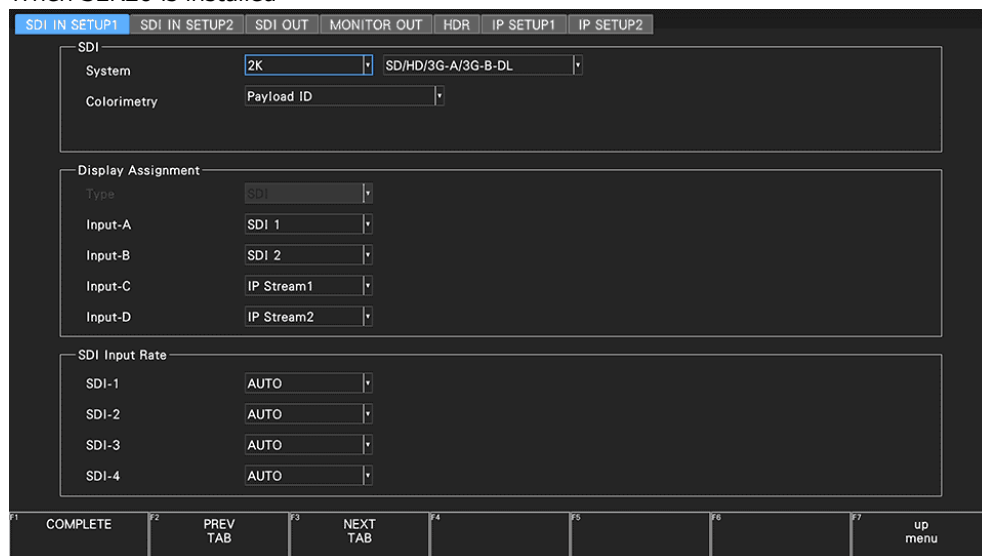

Figure 7-4 SDI IN SETUP1 tab

7. SYSTEM SETTINGS

7.1.3 Setting the Input Format

Use SDI Input Rate on the SDI IN SETUP1 tab to set the SDI input signal format.

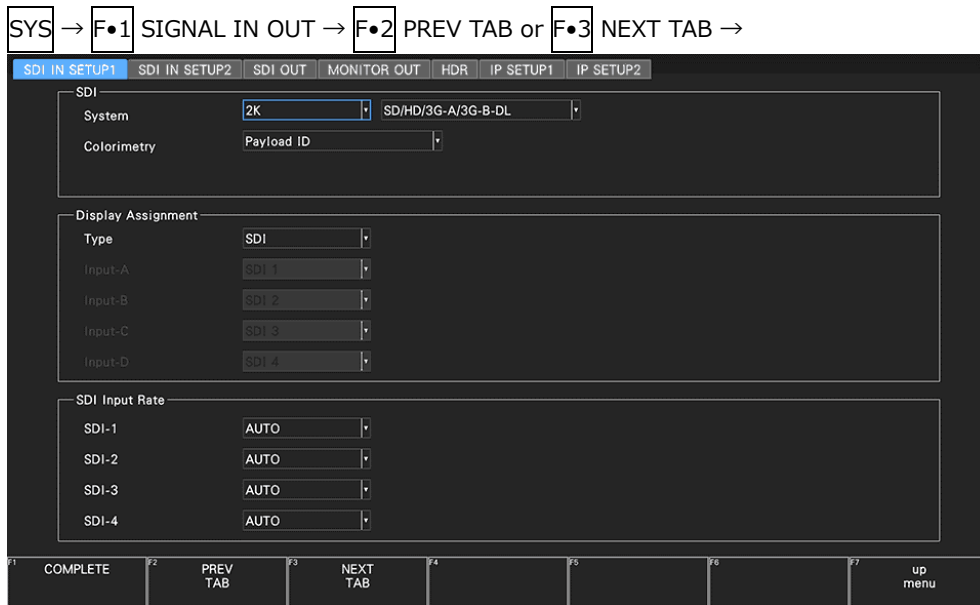

Figure 7-5 SDI IN SETUP1 tab

- SDI Input Rate

Select the format of the signal to receive from SDI INPUT 1 to 4. In normal cases, use AUTO. If you select a setting other than AUTO and apply a signal different from the selected format, the signal will not be received correctly.

AUTO / 12G / 6G / 3G / HD / SD

7. SYSTEM SETTINGS

7.1.4 Setting the Payload ID

User Format on the SDI IN SETUP2 tab to set the payload ID parameters.

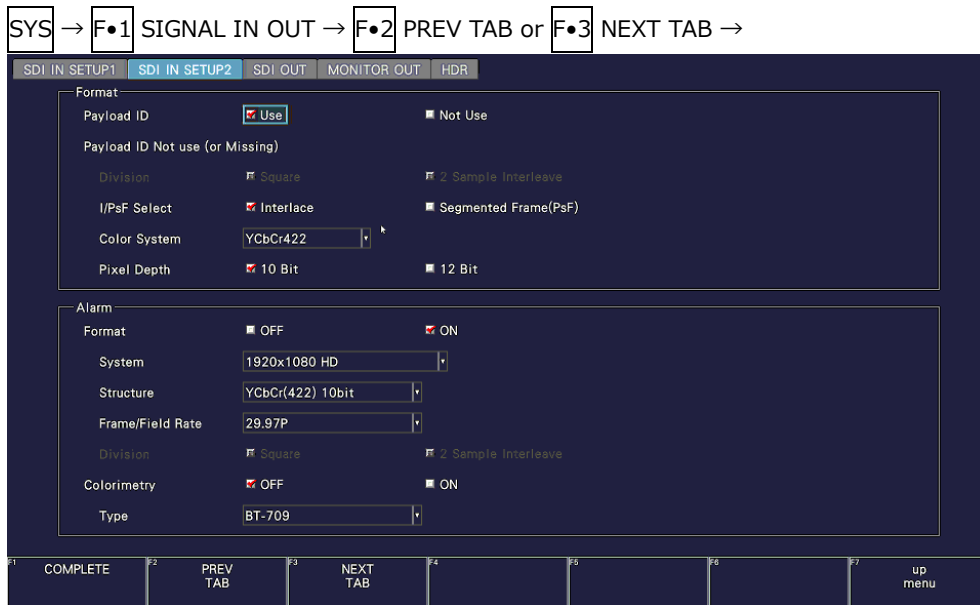

Figure 7-6 SDI IN SETUP2 tab

- Payload ID

Select whether to use the payload ID for input format identification.
This cannot be selected when SDI System is 4K HD Quad Link.

Use / Not Use

If you select Not Use, set the items marked with a Y in. The instrument will operate using the specified settings.

If you select Use, the items marked with a Y will be detected from the payload ID. There is no need to set these items, but if you set them and a payload ID is not embedded in the input signal, the instrument will operate using the specified settings.

Regardless of whether you select Use or Not Use, items such as scanning and frame frequency will be detected from the TRS.

7. SYSTEM SETTINGS

Table 7-1 Payload ID settings.

Input Signal	Division	i/PsF Select	Color System	Pixel Depth
HD	Cannot be set	Y	No need to set (fixed to YCbCr 422)	No need to set (fixed to 10 bits)
SD	Cannot be set	No need to set (fixed to interlace)	No need to set (fixed to YCbCr 422)	No need to set (fixed to 10 bits)
3G-A, 3G-B-DL	Cannot be set	Y	Y	Y
3G-B DS	Cannot be set	Y	Cannot be set	Cannot be set
6G	Cannot be set	Cannot be set	Cannot be set	Cannot be set
12G	Cannot be set	Cannot be set	Y	Y
HD(DL)	Cannot be set	Y	Y	Y
3G(DL)-2K	Cannot be set	Cannot be set	Y	Y
3G(DL)-4K	Y	Cannot be set	Cannot be set	Cannot be set
3G(QL)	Y	Cannot be set	Y	Y

- Division

Selects the division transmission system when SDI System is 4K 3G Dual Link, or 4K 3G Quad Link.

If you select 2 Sample Interleaved when Psf format is in use, the instrument will not operate properly.

Square / 2 Sample Interleave

- i/PsF Select

The instrument cannot detect the following formats if the payload ID is not in use or is not embedded. In such a case, select whether to use interlace or segmented frame for displaying.

This cannot be selected when SDI System is 4K or 2K 3G Dual Link.

- 1080/60I and 1080/30PsF
- 1080/59.94I and 1080/29.97PsF
- 1080/50I and 1080/25PsF

Interlace / Segmented Frame(PsF)

- Color System

Select the color system of the input signal.

SDI System is 2K 3G-B DS, 4K 6G, 4K 3G Dual Link or 4K HD Quad Link, this is fixed to YCbCr 422, and you cannot change it.

YCbCr 422 / YCbCr 444 / RGB 444 / XYZ 444

- Pixel Depth

Select the quantization of the input signal.

SDI System is 3G-B DS, 4K 6G, 4K 3G Dual Link or 4K HD Quad Link, this is fixed to 10 bit, and you cannot change it.

10bit / 12bit

7. SYSTEM SETTINGS

7.1.5 Setting the Format Alarm

User Alarm on the SDI IN SETUP2 tab to set the format alarm parameters.

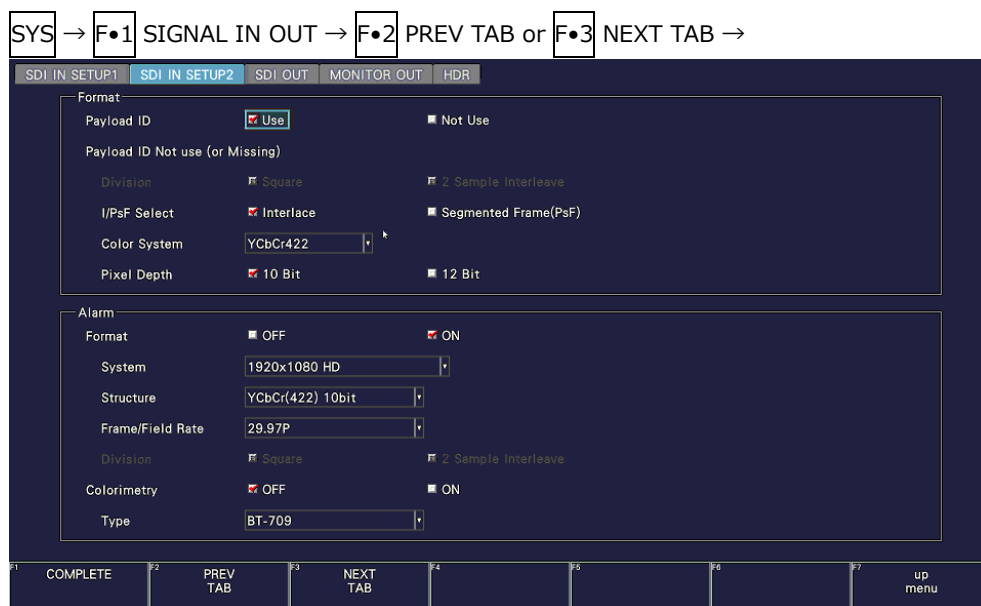

Figure 7-7 SDI IN SETUP2 tab

- Format

Turn on and off the format alarm detection.

If alarm detection is set to ON and a format other than the format specified with Format is received, the instrument operates in the following manner.

- Displays the format in yellow
- Displays errors in the event log of the status display
- Displays "ERROR" in the upper right of the display.
- Transmits a signal from the alarm output remote terminal

OFF / ON

7. SYSTEM SETTINGS

- System
- Structure
- Frame/Field Rate
- Division

When format alarm detection is on, specify the expected format. For information on the format combinations that are available, see section 3.3.1, "SDI Video Formats and Standards," and 3.3.2, "IP Video Formats and Standards (SER05/SER06)."

Table 7-2 Format selection

Video System	System	Structure	Frame/Field Rate	Division
4K 12G	3840x2160 12G 4096x2160 12G	YCbCr(422) 10 bit YCbCr(422) 12 bit YCbCr(444) 10 bit YCbCr(444) 12 bit RGB(444) 10 bit RGB(444) 12 bit	60/59.94/50/48/47.95/ 30/29.97/25/24/23.98/P	-
4K 6G	3840x2160 6G 4096x2160 6G	YCbCr(422) 10bit	30/29.97/25/24/23.98/P	-
4K 3G Quad Link	3840x2160 3G-B-DL Quad 4096x2160 3G-B-DL Quad 3840x2160 3G-A Quad 4096x2160 3G-A Quad	YCbCr(422) 10 bit YCbCr(422) 12 bit YCbCr(444) 10 bit YCbCr(444) 12 bit RGB(444) 10 bit RGB(444) 12 bit	60/59.94/50/48/47.95/ 30/29.97/25/24/23.98/P 30/29.97/25/24/23.98/PsF	Square/ 2 Sample Interleave
4K 3G Dual Link	3840x2160 3G-B-DS Dual 4096x2160 3G-B-DS Dual	YCbCr(422) 10 bit	30/29.97/25/24/23.98/P 30/29.97/25/24/23.98/PsF	Square/ 2 Sample Interleave
4K HD Quad Link	3840x2160 HD Quad 4096x2160 HD Quad	YCbCr(422) 10 bit	30/29.97/25/24/23.98/P 30/29.97/25/24/23.98/PsF	-
SD/HD/3G-A/3G-B-DL	1920x1080 3G-B-DL 2048x1080 3G-B-DL 1280x720 3G-A 1920x1080 3G-A 2048x1080 3G-A 1280x720 HD 1920x1080 HD 720x487 SD 720x576 SD	YCbCr(422) 10 bit YCbCr(422) 12 bit YCbCr(444) 10 bit YCbCr(444) 12 bit RGB(444) 10 bit RGB(444) 12 bit	60/59.94/50/I 60/59.94/50/48/47.95/ 30/29.97/25/24/23.98/P 30/29.97/25/24/23.98/PsF	-
HD Dual Link	1920x1080 HD Dual 2048x1080 HD Dual	YCbCr(422) 10 bit YCbCr(422) 12 bit YCbCr(444) 10 bit YCbCr(444) 12 bit RGB(444) 10 bit RGB(444) 12 bit	60/59.94/50/I 60/59.94/50/48/47.95/ 30/29.97/25/24/23.98/P 30/29.97/25/24/23.98/PsF	-
3G Dual Link	1920x1080 3G-B-DL Dual 2048x1080 3G-B-DL Dual 1920x1080 3G-A Dual 2048x1080 3G-A Dual	YCbCr(422) 12 bit YCbCr(444) 10 bit YCbCr(444) 12 bit RGB(444) 10 bit RGB(444) 12 bit	60/59.94/50/48/47.95/P	-
3G-B DS	1280x720 3G-B-DS 1920x1080 3G-B-DS	YCbCr(422) 10 bit	60/59.94/50/I 60/59.94/50/ 30/29.97/25/24/23.98/P 30/29.97/25/24/23.98/PsF	-

7. SYSTEM SETTINGS

- Colorimetry

Turn on and off the colorimetry alarm detection.

Normally, colorimetry is displayed in cyan on the vector waveform display and CIE chromaticity diagram display. But for 3G(QL) and 3G(DL)-4K, if any of the colorimetries does not match, it is displayed in yellow.

If alarm detection is set to on and a colorimetry other than that specified with Type is received, the colorimetry is displayed in red. It is also displayed in red on the video signal waveform display.

Note that this is invalid when the input signal is SD.

OFF / ON

- Type

When colorimetry alarm detection is on, specify the expected colorimetry.

BT-709 / BT-2020 / DCI

7.1.6 Configuring the SDI Output Connectors

Use Output on the SDI OUT tab to configure the SDI OUTPUT connectors on the rear panel.

SYS → F•1 SIGNAL IN OUT → F•2 PREV TAB or F•3 NEXT TAB →



Figure 7-8 SDI OUT tab

7. SYSTEM SETTINGS

- Mode

Select the signal that is generated from SDI OUTPUT.

If SER24 TSG is not installed, Test Signal cannot be selected.

Input Through: Transmits the reclocked version of the signal that has been received by the SDI INPUT 1 to 4 connectors.

If SER26 LAYOUT is installed, you can output the signal assigned with Display Assignment on the SDI IN SETUP1 tab.

When SDI system setting is 2K SD/HD/3G-B-DL/3G-A and input signal is 6G-SDI, reclock output is not possible.

Test Signal: Transmits the pattern specified by Test Signal.

- Follow the Display Assignment

If Mode is set to Input Through and SER26 LAYOUT is installed, selecting this check box outputs the signal assigned with Display Assignment on the SDI IN SETUP1 tab. If an IP signal is assigned, the signal is converted into an SDI signal and output.

- Through Out (SDI1)

When Mode is set to Input Through, select the signal to output from SDI OUTPUT 1.

When SDI system setting is 2K SD/HD/3G-B-DL/3G-A and input signal is 6G-SDI, reclock output is not possible.

Fixed (1): Transmits the reclocked version of the signal that has been received by the SDI INPUT 1 connector.

Selection (1/2/3/4): Transmits the reclocked version of the signal that has been received by the SDI INPUT 1 to 4 connectors.

To select the output channel, use the INPUT menu or F•6 INPUT SELECT on each measurement screen.

7. SYSTEM SETTINGS

7.1.7 Configuring the TSG Settings (SER24)

When Mode on the SDI OUT tab is set to Test Signal, use the parameters under Test Signal to set the TSG to output from SDI OUTPUT on the rear panel.

SYS → **F•1** SIGNAL IN OUT → **F•2** PREV TAB or **F•3** NEXT TAB →



Figure 7-9 SDI OUT tab

7. SYSTEM SETTINGS

- System
- Structure
- Frame/Field Rate

Set the output format. The possible format combinations are shown below. The default values are 1920x1080 HD, YCbCr(422) 10 bit, 59.94I.

Table 7-3 Output format selection

System	Structure	Frame/Field Rate
3840x2160 12G	YCbCr(422) 10 bit	60/59.94/50/48/47.95/P
4096x2160 12G	YCbCr(444) 10 bit RGB(444) 10 bit	30/29.97/25/24/23.98/P
3840x2160 6G	YCbCr(422) 10bit	30/29.97/25/24/23.98/P
4096x2160 6G		
3840x2160 3G-B-DL Quad	YCbCr(422) 10 bit	60/59.94/50/48/47.95/P
4096x2160 3G-B-DL Quad	YCbCr(444) 10 bit	30/29.97/25/24/23.98/P
3840x2160 3G-A Quad	RGB(444) 10 bit	30/29.97/25/24/23.98/PsF
4096x2160 3G-A Quad		
2048x1080 3G-B-DL		
2048x1080 3G-A		
3840x2160 3G-B-DS Dual	YCbCr(422) 10 bit	30/29.97/25/24/23.98/P
4096x2160 3G-B-DS Dual		30/29.97/25/24/23.98/PsF
1920x1080 3G-B-DL	YCbCr(422) 10 bit	60/59.94/50/48/47.95/P
1920x1080 3G-A	YCbCr(444) 10 bit RGB(444) 10 bit	60/59.94/50/I 30/29.97/25/24/23.98/P 30/29.97/25/24/23.98/PsF
1920x1080 HD	YCbCr(422) 10 bit	60/59.94/50/I 30/29.97/25/24/23.98/P 30/29.97/25/24/23.98/PsF
1280x720 HD	YCbCr(422) 10 bit	60/59.94/50/P 30/29.97/25/24/23.98/P

- Division

Selects the division transmission system when System is Quad or Dual.

Square / 2 Sample Interleave

7. SYSTEM SETTINGS

- Pattern
- Interlock

Select the output pattern. The selectable patterns are shown below. The selectable patterns vary depending on the System setting.

Depending on the pattern, you can turn on and off YCbCr or RGB separately.

For COLOR RASTER, you can set the YCbCr or RGB levels separately. Moreover, if Structure is set to RGB, you can select the Interlock check box to synchronize the RGB levels.

Table 7-4 Output pattern selection

Pattern	YCbCr/RGB on/off	Level adjustment
COLOR BAR 100%	Yes	No
COLOR BAR 75%	Yes	No
ARIB2020 COLOR BAR (*1)	Yes	No
MULTI COLOR BAR 100% (*1)	Yes	No
MULTI COLOR BAR 75% (*1)	Yes	No
MULTI COLOR BAR (+I) (*1)	Yes	No
COLOR RASTER	Yes	Yes
OETF	Yes	No
CROSS HATCH	Yes	No
10_STEP	Yes	No
LIMIT RAMP	Yes	No
CHECK FIELD	No	No
LIP SYNC (SER03)	No	No
HDR COLOR BAR (SER23) (*1)	Yes	No

* The signal will be interrupted when the pattern is changed.

*1 It cannot be set in horizontal 2048 and 4096 pixel format.

When OETF is selected, select the gamma characteristics.

BT-709 / HLG / PQ

Note that bandwidth limit is not applied to patterns other than COLOR BAR 100% and COLOR BAR 75%.

7. SYSTEM SETTINGS

- Scroll

Select the scroll direction for when a pattern is scrolled.

If a setting other than OFF is selected, Moving Box and Phase Difference are turned off.

You cannot select this when Pattern is set to CROSS HATCH.

OFF

RIGHT: Scrolls from left to right.

LEFT: Scrolls from right to left.

UP: Scrolls from bottom to top.

DOWN: Scrolls from top to bottom.

RIGHT & UP: Scrolls from lower left to upper right.

RIGHT & DOWN: Scrolls from upper left to lower right.

LEFT & UP: Scrolls from lower right to upper left.

LEFT & DOWN: Scrolls from upper right to lower left.

- Speed

When Scroll is not set to off, set the scroll speed.

4 - 124 dots (4 dot steps)

- Moving Box

If you select the color of the moving box, a square that moves randomly is superimposed.

If a setting other than OFF is selected, Scroll and Phase Difference are turned off.

OFF / WHITE / YELLOW / CYAN / GREEN / BLUE / RED / MAGENTA / BLACK

- Speed

When Moving Box is not set to off, set the moving box speed.

Greater the value, higher the speed.

1 - 3

- Phase Difference

If H or V is selected, the phase of other channels can be varied relative to Ach.

When System is set to Quad, you can adjust the Bch, Cch, and Dch phases relative to Ach.

When System is set to Dual, you can adjust the Bch phase relative to Ach and the Dch phase relative to Cch.

If a setting other than OFF is selected, Scroll and Moving Box are turned off.

OFF / H / V

7. SYSTEM SETTINGS

- Bch, Cch, Dch, or B/Dch

When Phase Difference is not set to off, you can adjust the Bch, Cch, and Dch phases. When System is set to Dual, the Bch and Dch phases are shared.

Phase Difference = H

-1374 - 0 - 1374 dots (depending on Frame/Field Rate)

Phase Difference = V

-562 - 0 - 562 Dot

- Embedded Audio

When the pattern is not LIP SYNC, select the audio channels to embed in the SDI signal. 1 to 4ch is referred to as G1, 5 to 8ch as G2, 9 to 12ch as G3, and 13 to 16ch as G4.

The channels that can be embedded are 8 channels or 16 channels depending on the system and frame/field rate as shown below.

Table 7-5 Embedded audio settings

System	Frame/Field Rate	G1	G2	G3	G4
3840x2160 12G 4096x2160 12G 3840x2160 6G 3840x2160 3G-B-DL Quad 3840x2160 3G-A Quad 4096x2160 3G-A Quad 3840x2160 3G-B-DS Dual 1920x1080 3G-B-DL 1920x1080 3G-A 2048x1080 3G-A 1920x1080 HD 1280x720 HD	-	Yes	Yes	Yes	Yes
4096x2160 6G	-	Yes	Yes	No	No
4096x2160 3G-B-DL Quad 2048x1080 3G-B-DL	60/59.94/30/29.97/P 30/29.97/PsF	Yes	Yes	No	No
	50/48/47.95/25/24/23.98/P 25/24/23.98/PsF	Yes	Yes	Yes	Yes
4096x2160 3G-B-DS Dual	30/29.97/P 30/29.97/PsF	Yes	Yes	No	No
	25/24/23.98/P 25/24/23.98/PsF	Yes	Yes	Yes	Yes

7. SYSTEM SETTINGS

- Level

Select the embedded audio level.

-20dBFS / -18dBFS / 0dBFS / Mute

- CRC Error

When set to on, an incorrect CRC is inserted into the Y component of the first line.

OFF / ON

7.1.8 Configuring the Monitor Output Connectors

Use LCD, TMD5, and SDI on the MONITOR OUT tab to configure the MONITOR OUTPUT connectors on the rear panel and the instrument's LCD.

SYS → **F•1** SIGNAL IN OUT → **F•2** PREV TAB or **F•3** NEXT TAB →

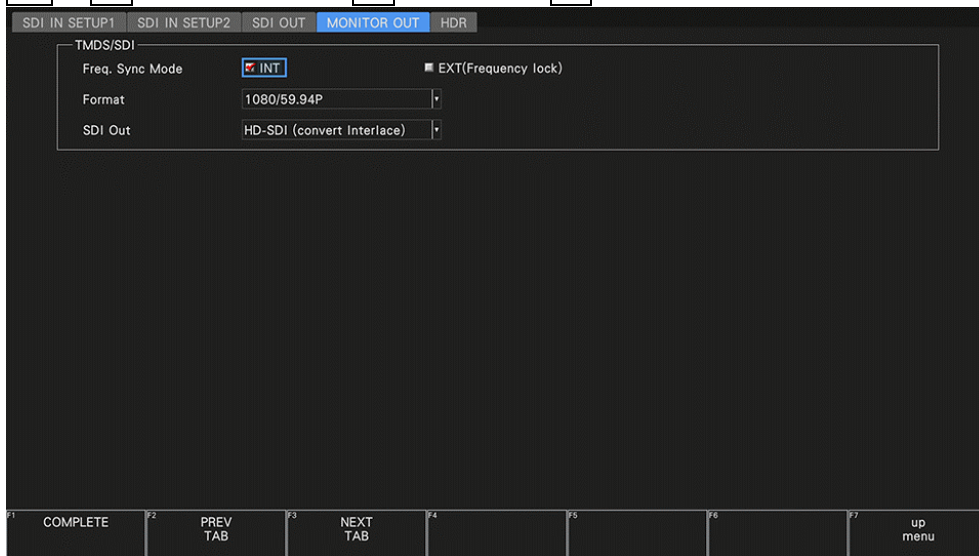

Figure 7-10 MONITOR OUT tab

- Freq. Sync Mode

Select the sync mode.

INT: Transmits in the selected format by using the internal clock.

EXT (Frequency lock):

Transmits by using the external sync signal received through EXT REF. The output signal format varies depending on the frame frequency of the external sync signal as follows.

30 Hz:	1080/60p
29.97 Hz:	1080/59.94p
25 Hz:	1080/50p
24 Hz or 23.98 Hz:	INT
24Hz:	1080/48p
23.98Hz:	1080/47.95p
When there is no external sync signal:	INT

7. SYSTEM SETTINGS

- Format

If Freq Sync Mode is set to INT, select the frame frequency of the output signal.

1080/60P / 1080/59.94P / 1080/50P / 1080/48P / 1080/47.95P

- SDI Out

Select the output format of the SDI signal.

If HD-SDI (convert Interlace) is selected, the frame frequency selected with Format is switched and output in the following manner.

1080/60P → 1080/60I
 1080/59.94P → 1080/59.94I
 1080/50P → 1080/50I
 1080/48P → 1080/24PsF (*1)
 1080/47.95P → 1080/23.98PsF (*1)

*1 Equivalent to 48I when the SDI input is 48P.

HD-SDI (convert Interlace) / 3G-SDI Level-A / 3G-SDI Level-B

7.1.9 Configuring the HDR Settings (SER23)

On the HDR tab, configure the settings of HDR measurement for each display channel (Input A to D).

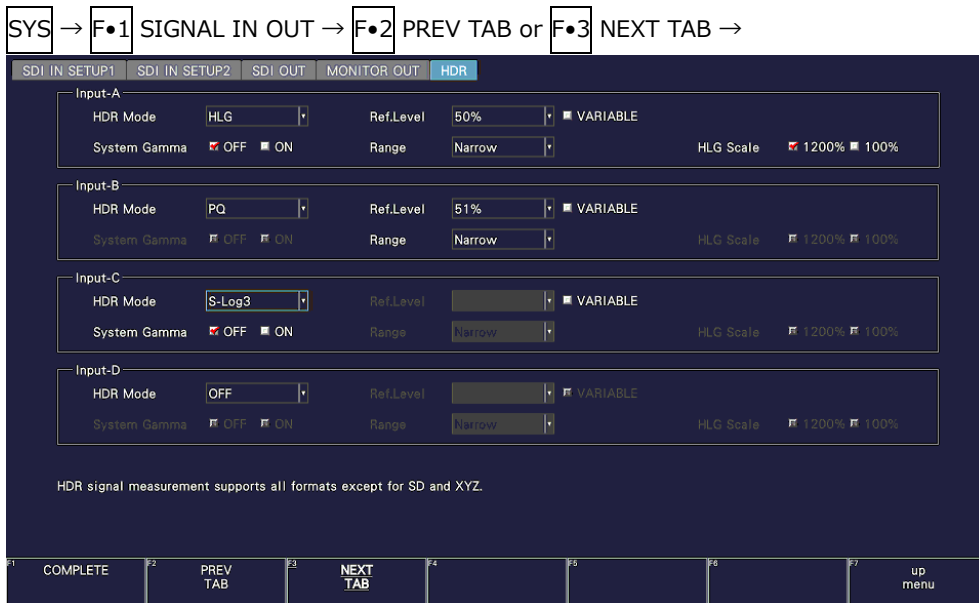

Figure 7-11 HDR tab

7. SYSTEM SETTINGS

- HDR Mode

Turn off the HDR measurement, or select the HDR signal standard. If you select an HDR signal standard, HDR signals can be measured on the video-signal-waveform, vector, and picture displays.

HLG and PQ refer to ITU-R BT.2100, and S-Log3, C-Log, and Log-C refer to the log curve output from cameras of other manufacturers.

OFF:	An HDR scale is not displayed.
HLG:	When HLG Scale is 1200% (default value), 0 to 100% is displayed as 0 to 1200%. When HLG Scale is 100% (default value), 0 to 100% is displayed as 0 to 100%.
PQ:	0 to 100 % is displayed as 0 to 10000 Nits.
S-Log3:	If 0 to 100% is set to 64 to 940, 95 to 940 is displayed as 0 to 2055%.
C-Log:	Displays the percentage with the SDI code value 128 assumed to 0% and 614 assumed to be 100%
Log-C:	EI = 200 Displays the percentage with the SDI code value 95 assumed to 0.39% and 853 assumed to be 83% EI = 400 Displays the percentage with the SDI code value 95 assumed to 0.39% and 917 assumed to be 90% EI = 800 Displays the percentage with the SDI code value 95 assumed to 0.39% and 976 assumed to be 95% EI = 1600 Displays the percentage with the SDI code value 95 assumed to 0.39% and 1022 assumed to be 94%
PayloadID UnSpec:S-Log3:	Operates in OFF (SDR-TV), HLG, or PQ mode according to the payload ID information. When the payload ID information is Unspecified, the instrument operates in S-Log3 mode.
PayloadID UnSpec:C-Log:	Operates in OFF (SDR-TV), HLG, or PQ mode according to the payload ID information. When the payload ID information is Unspecified, the instrument operates in C-Log mode.
PayloadID UnSpec:Log-C:	Operates in OFF (SDR-TV), HLG, or PQ mode according to the payload ID information. When the payload ID information is Unspecified, the instrument operates in Log-C mode.

7. SYSTEM SETTINGS

- Ref. Level

When HDR Mode is set to HLG or PQ, select the reference level for the program production. When HDR Mode is set to S-Log3, C-Log, or Log-C, it is set to default value and cannot be selected.

When HDR Mode is set to PayloadID UnSpec:S-Log3, PayloadID UnSpec:C-Log, or PayloadID UnSpec:Log-C, select the level by combining the HLG and PQ levels. The HLG or PQ reference level selected with Ref. Level is applied according to the payload ID information. When the payload ID information is Unspecified, the S-Log3, C-Log, or Log-C reference level is applied. When the payload ID information is OFF (SDR-TV), the reference level is not applied.

On the video signal waveform display, the selected reference level is shown using broken lines on the scale.

On the picture display, the selected reference level is set to the REF default value on the HDR signal CINEZONE display. The REF default value is applied when you press the function dial (F•D).

HDR Mode = HLG

50% / 75%

HDR Mode = PQ

51% / 58%

HDR Mode = S-Log3

61%

HDR Mode = C-Log

63%

HDR Mode = Log-C

58%

HDR Mode = PayloadID UnSpec:S-Log3

HLG:50%,PQ:51% / HLG:50%,PQ:58% / HLG:75%,PQ:51% / HLG:75%,PQ:58%

HDR Mode = PayloadID UnSpec:C-Log

HLG:50%,PQ:51% / HLG:50%,PQ:58% / HLG:75%,PQ:51% / HLG:75%,PQ:58%

HDR Mode = PayloadID UnSpec:Log-C

HLG:50%,PQ:51% / HLG:50%,PQ:58% / HLG:75%,PQ:51% / HLG:75%,PQ:58%

- Variable

Select whether to enable the reference level setting.

The default reference level is set to the Ref.Level value.

OFF / ON

7. SYSTEM SETTINGS

- EI

When HDR Mode is set to Log-C, select the EI value.

200 / 400 / 800 / 1600

- System Gamma

When HDR Mode is set to HLG or S-Log3, turn system gamma on or off.

If system gamma is set to on, the scale corresponding to the HDR signal of the video signal waveform display and picture display is shown in Nits, which is a unit of display intensity for HLG displays.

When HDR Mode is set to HLG, gamma 1.2 is used to calculate the intensity with the full scale ranging up to 1000 Nits.

When HDR Mode is set to S-Log3, the intensity is displayed with the full scale ranging up to 3000 Nits.

OFF / ON

- Range

When HDR Mode is set to HLG or PQ, select the range.

Narrow / Full

- HLG Scale

When HDR Mode is set to HLG, select the HDR scale display.

1200%: 0 to 100 % is displayed as 0 to 1200%.

100%: 0 to 100 % is displayed as 0 to 100%.

7. SYSTEM SETTINGS

7.1.10 Configuring the IP Signal Settings (SER05/SER06)

Use IP Setup on the IP SETUP1 tab to configure the IP input signal settings.

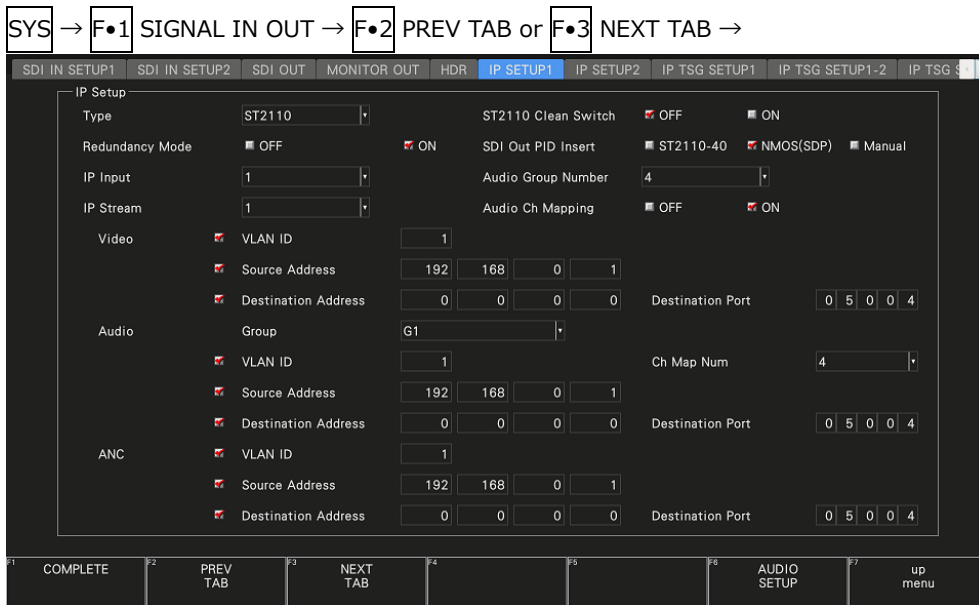

Figure 7-12 IP SETUP1 tab

- Type

Select the IP signal standard.

<u>ST2022-6:</u>	Measures signals conforming to SMPTE ST 2022-6. Cannot be selected when System on the SDI IN SETUP1 tab is 4K.
ST2110:	Measures signals conforming to SMPTE ST 2110-20.
ST2110 TSG:	Measures signals conforming to SMPTE ST 2110-20. The packet emulation settings are enabled and the picture or waveform decoded from the IP signal cannot be displayed. Also, the SDI signal decoded from the IP signal cannot be output. (See also 7.1.17, "Setting the IP TSG Packet Emulation (SER32).") It can be selected when SER06 and SER32 are installed.
ST2110 JXS:	JPEG XS signals conforming to SMPTE ST 2110-22 and signals conforming to SMPTE ST 2110-20 are measured. Only stream 1 can measure JPEG XS signals. Also, streams 3 and 4 cannot be measured. It can be selected when SER33 is installed. Cannot be selected when System on the SDI IN SETUP1 tab is 4K IP Quad Stream. When measuring a highly compressed JPEG XS signal, the borders of the image may become blurred.

7. SYSTEM SETTINGS

- ST2110 Clean Switch (SER06)

Set the clean switch function on or off. When set to on, images can be seamlessly switched when controlling with NMOS.

Notes on the clean switch function are as follows.

- Can be set when Type is ST2110.
- Supports only stream 1 switching. IP Stream 2 to 4 cannot be selected.
- When converting an IP signal to an SDI signal and outputting it, the SDI signal is also seamlessly switched.
- The switching source and switching destination signals must be in the same format and synchronized.
- IP TSG function (SER32) cannot be used.

OFF / ON

- Redundancy Mode

Set the redundancy mode to on or off.

OFF / ON

- SDI Out PID Insert

Select the PayLoad ID format information to insert into the SDI output converted from IP to SDI. The 4K input signal is converted to 3G-Quad Link, so the 3G Quad Link payload ID is inserted.

If the PayLoad ID is inserted in ST2110-40, that information is inserted. When Type is set to ST2110 or ST2110 JXS, this can be selected.

ST2110-40 / NMOS(SDP) / Manual

- IP Input

Select which IP input you want to configure. You can set the following parameters for each IP input and IP stream.

You can select 2 when Redundancy Mode is set to ON.

1 / 2

- Audio Group Number

You can assign multiple SMPTE ST 2110-30 / 31 audios to IP Stream 1 - 4.

When the Audio Group Number is 1, all audios are assigned in the same stream.

When the Audio Group Number is 2, audio groups 1 and 2 are assigned to the G1 stream, and groups 3 and 4 are assigned to the G2 Stream.

When the Audio Group Number is 4, audio groups 1 - 4 are assigned to the G1 - G4 stream.

You can select the Audio Group Number when SER06 is installed and Type is set to ST2110, ST2110 TSG, or ST2110 JXS.

1 / 2 / 4

7. SYSTEM SETTINGS

- IP Stream

Select which IP stream you want to configure. With the exception of the Audio Group selection, you can set the following parameters for each IP input and IP stream.

3 and 4 cannot be selected when Type is ST2110 JXS.

When ST2110 Clean Switch is set to ON, 2 to 4 cannot be selected.

1 / 2 / 3 / 4

- Audio Ch Mapping

When turned ON, you can freely set the number of channels assigned to G1 to G4 when Audio Group Number is 2 or 4. Set the number of channels using Ch Map Num.

OFF / ON

- VLAN ID

For the signals selected with IP Input and IP Stream, select the VLAN ID check box and then configure them.

When Type is set to ST2022-6, set only for Video.

1 - 4094

- Source Address

For the signals selected with IP Input and IP Stream, select the check boxes and assign their source IP addresses.

If you do not select the check boxes, they will be assigned automatically on a first-come-first-served basis. They can also be assigned by pressing a single key on the status screen.

When Type is set to ST2022-6, set only for Video.

[See also] 16.8.2, "Configuring the IP Status Screen."

192.168.0.1

- Destination Address, Destination Port

For the signals selected with IP Input and IP Stream, select the check boxes and assign their destination IP addresses and port numbers.

If you do not select the check boxes, they will be assigned automatically on a first-come-first-served basis. They can also be assigned by pressing a single key on the status screen.

When Type is set to ST2022-6, set only for Video.

0.0.0.0 / 05004

7. SYSTEM SETTINGS

- Warning message

If the address settings on the IP SETUP1 tab are duplicated in multiple streams, a warning message will be displayed.

If the address settings are duplicated, those are shown in the following order.

Port1 / 2 : Video / Audio / ANC 1 / 2 / 3 / 4

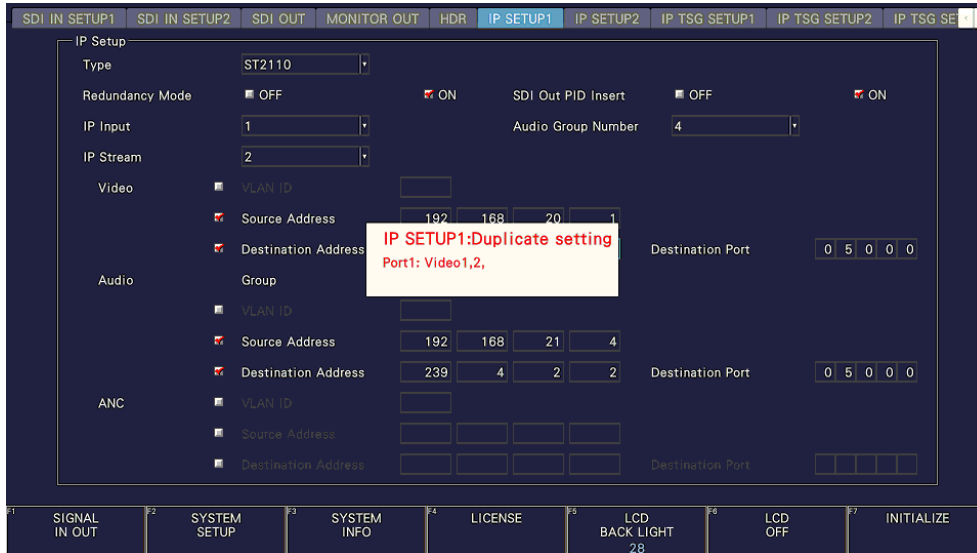

Figure 7-13 IP SETUP1 tab (Warning message)

7. SYSTEM SETTINGS

- Group

Select the group for which you want to set the audio address.

Cannot be selected when Type is ST2022-6.

G1 / G2 / G3 / G4

Audio settings can also be made on the IP SETUP1 tab, but when the Audio Group Number is 2 or 4, it is convenient to make them on the IP SETUP1 AUDIO tab of **F•6** AUDIO SETUP. Since G1 to G4 are displayed on one screen, settings can be made without switching Groups.

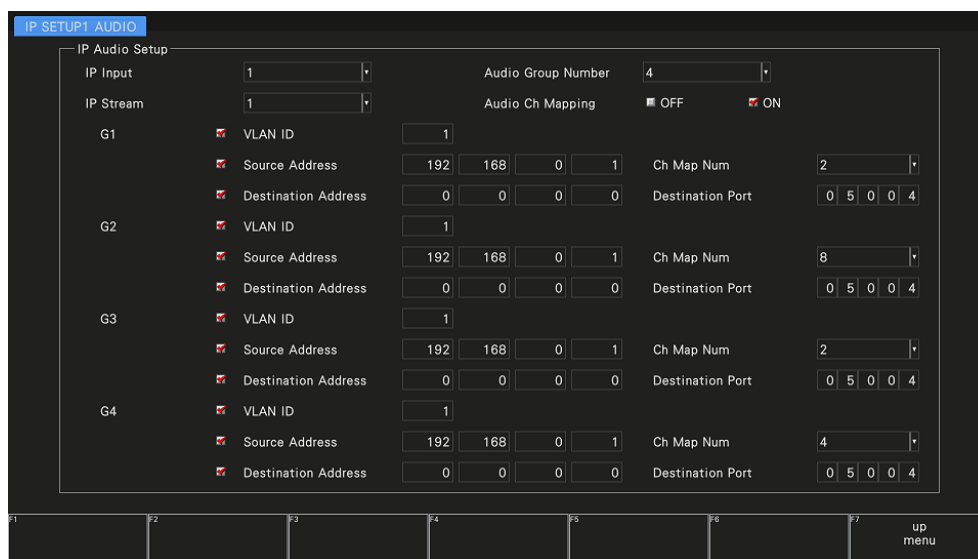

Figure 7-14 IP SETUP1 AUDIO tab

- Ch Map Num

When Audio Ch Mapping is set to ON, set the number of channels assigned to G1 to G4.

When Audio Group Number is 2, set so that the total of G1 and G2 is 16ch or less, and when Audio Group Number is 4, set so that the total of G1 to G4 is 16ch or less.

If the total number of channels exceeds 16, the number of channels in other groups will automatically change in the order of G4 > G3 > G2 > G1.

For example, set Audio Group Number to 4 and Ch Map Num to all 4. If you set G3's Ch Map Num to 10, G4's Ch Map Num will automatically change to 0 and G2's Ch Map Num will change to 2.

0 - 16

7. SYSTEM SETTINGS

7.1.11 Configuring the PTP Settings (SER05/SER06)

Use PTP Setup on the IP SETUP2 tab to configure the PTP settings.

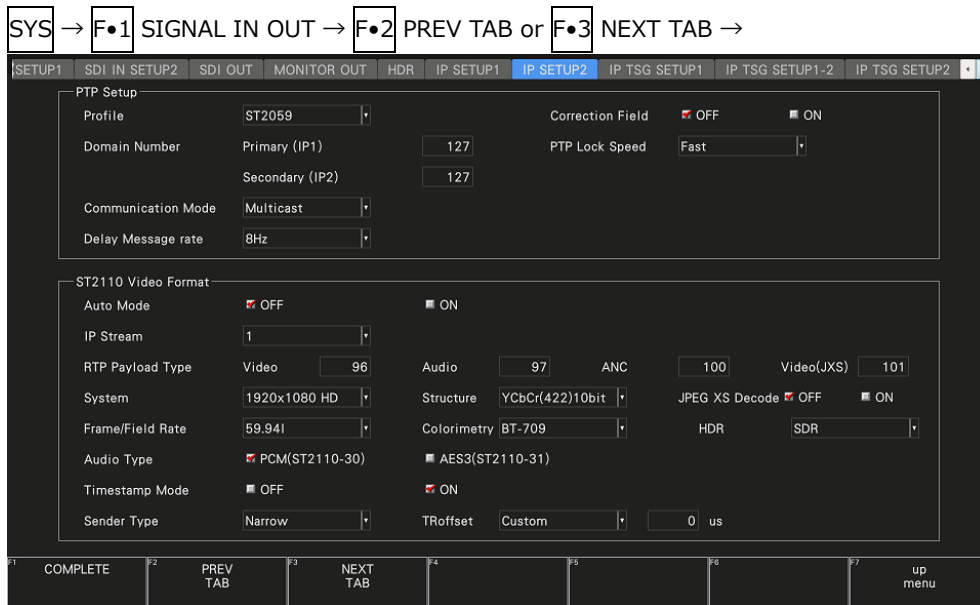

Figure 7-15 IP SETUP2 tab

- Profile

PTP Profile is ST2059.

- Correction Field

Turns PTP residence time correction on and off. When set to on, the residence time is corrected. When set to off, the residence time will not be corrected.

OFF / ON

- Domain Number Primary

- Domain Number Secondary

Set the domain number.

0 - 127

- PTP Lock Speed

Set the PTP lock speed.

When set to Fast, it takes only a short time until PTP locks if a time lag occurs. But reception may be unstable because of the large gain in an environment that PTP TimeOffset fluctuates by nearly 1us.

When set to Very Slow, it takes a long time until PTP locks if a time lag occurs. But reception would be stable because of the small gain even in an environment that PTP TimeOffset fluctuates by nearly 1us.

Fast / Slow / Very Slow

7. SYSTEM SETTINGS

- Communication Mode

Set the response of PTP messages.

Multicast / Mixed

- Delay Message rate

Set the DelayRequest message rate.

128Hz / 64Hz / 32Hz / 16Hz / 8Hz / 4Hz / 2Hz

7.1.12 Setting the Video Format (SER05/SER06)

Use ST2110 Video Format on the IP SETUP2 tab to set the video format for when the signal standard is set to ST2110.

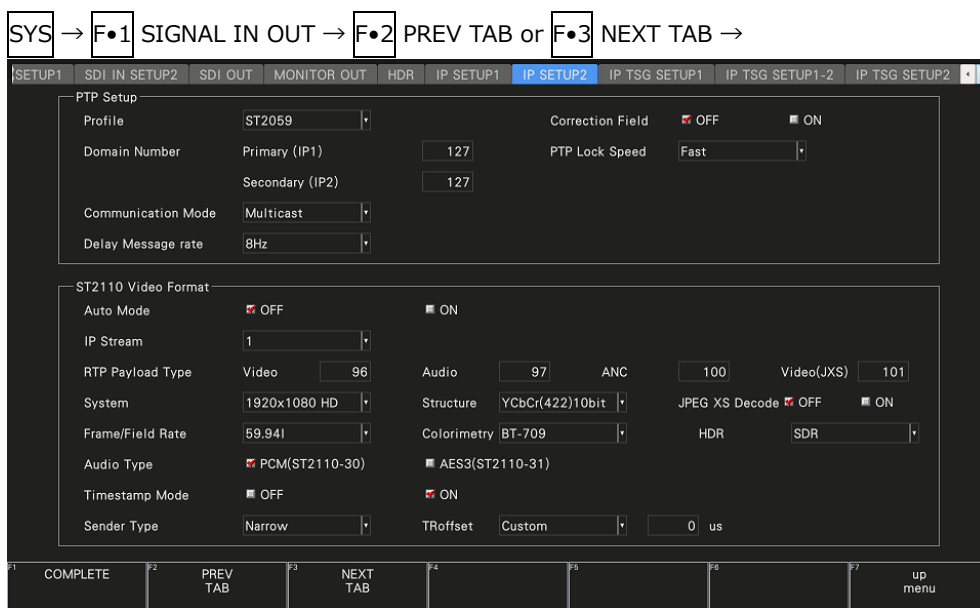

Figure 7-16 IP SETUP2 tab

- Auto Mode

When set to on, System, Structure, Frame/Field Rate, Colorimetry, and HDR are set automatically according to the marker bits of the ST2110-20/22 video signal.

OFF / ON

- IP Stream

Select which IP stream you want to configure. You can set the following parameters for each IP stream.

3 and 4 cannot be selected when Type on the IP SETUP1 tab is ST2110 JXS.

1 / 2 / 3 / 4

7. SYSTEM SETTINGS

- RTP Payload Type

Set the payload type of the signal selected with IP Stream. When the IP SETUP1 tab Type is ST2110 JXS, set Video(JXS) for Stream 1.

The default Video, Audio, ANC, and Video(JXS) values are 96, 97, 100, and 101 respectively.

96 - 127

- JPEG XS Decode

Select whether to decode JPEG XS signals when Type on the IP SETUP1 tab is ST2110 JXS and IP Stream is 1.

OFF / ON

- System

- Structure

- Frame/Field Rate

- Colorimetry

- HDR

Set format of the signal selected with IP Stream.

The combinations of formats that can be set are shown below. Default is 1920×1080 HD, YCbCr(422) 10bit, 59.94I, BT-709, SDR.

Table 7-6 Format selection

System	Structure	Frame/Field Rate	Colorimetry	HDR
3840x2160	YCbCr(422)10bit	60/59.94/50/30/29.97/25/24/23.98 P	BT-709	SDR
1920x1080 3GA	YCbCr(422)10bit	60/59.94/50 P	BT-2020	HLG
1920x1080 HD	YCbCr(422)10bit	30/29.97/25/24/23.98 P 60/59.94/50 I 30/29.97/25/24/23.98 PsF		PQ Undefined
1280x720 HD	YCbCr(422)10bit	60/59.94/50/30/29.97/25/24/23.98 P		

- Audio Type

Select the audio data type.

PCM(ST2110-30) / AES3(ST2110-31)

- Sender Type (SER06)

Select the transmission type of ST 2110 when measuring Cinst and VRX.

Narrow / Narrow Linear / Wide

7. SYSTEM SETTINGS

- TR offset (SER06)

Set the offset time at which the first packet of the frame is read from the reference time of the frame when measuring VRX and FPT.

Default / Custom

0 – 5000

- Timestamp Mode

When Redundancy Mode on the IP SETUP1 tab is set to OFF, select the timestamp mode.

<u>OFF:</u>	Reads in order of arrival without using the RTP timestamp of the signal synchronized with PTP.
<u>ON:</u>	Read using the RTP timestamp synchronized with PTP. When the LV5600 or LV7600 is not synchronized with PTP, it automatically operates with the OFF setting.

7.1.13 Setting the IP TSG Output (SER32)

Use IP Output on the IP TSG SETUP1 tab to configure the IP TSG output signal settings.

SYS → F•1 SIGNAL IN OUT → F•2 PREV TAB or F•3 NEXT TAB →

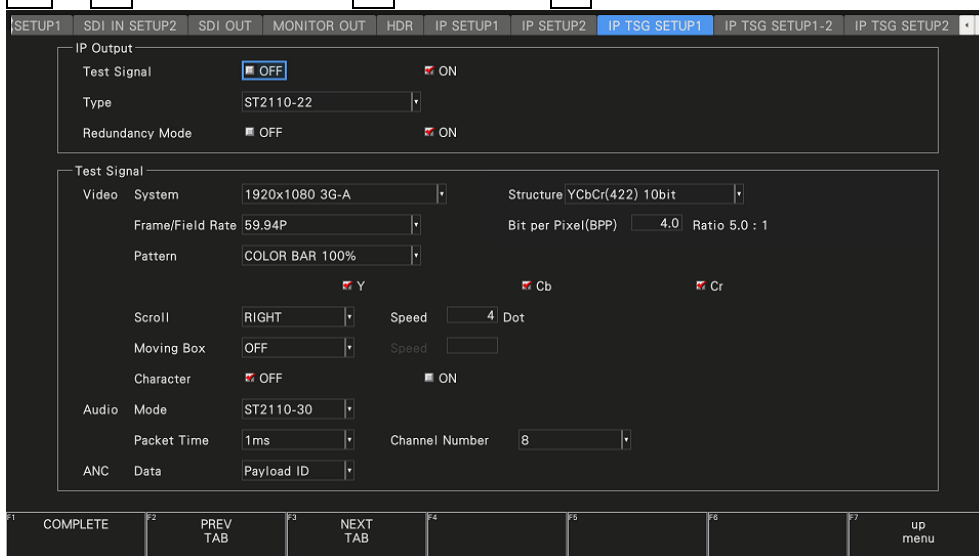

Figure 7-17 IP TSG SETUP1 tab

- Test Signal

Turns the IP TSG function on or off.

This cannot be set when ST2110 Clean Switch on the IP SETUP1 tab is set to ON.

OFF / ON

7. SYSTEM SETTINGS

- Type

Select the IP signal standard. The standard that can be selected depends on the Type on the IP SETUP1 tab.

ST2022-6	(When the IP SETUP1 tab Type is ST2022-6)
ST2110-20	(When the IP SETUP1 tab Type is ST2110)
ST2110 TSG	(When the IP SETUP1 tab Type is ST2110 TSG)
ST2110-20 / ST2110-22	(When the IP SETUP1 tab Type is ST2110 JXS)

- Redundancy Mode

Set the redundancy mode to on or off.

OFF / ON

7.1.14 Setting the IP TSG Signal (SER32)

When Test Signal is set to ON, use IP Test Signal on the IP TSG SETUP1 tab to configure the IP Test signal settings.



Figure 7-18 IP TSG SETUP1 tab

7. SYSTEM SETTINGS

- Video - System
- Video - Structure
- Video - Frame/Field Rate

Set the output format. The possible format combinations are shown below. The default values are 1920×1080 3G-A, YCbCr(422) 10 bit, 59.94P.

Table 7-7 Output format selection

System	Structure	Frame/Field Rate
3840×2160 Single Stream (*1)	YCbCr(422) 10bit	60/59.94/50/30/29.97/25/24/23.98 P
1920×1080 3G-A	YCbCr(422) 10bit	60/59.94/50 P
1920×1080 HD	YCbCr(422) 10bit	30/29.97/25/24/23.98 P 60/59.94/50 I 30/29.97/25/24/23.98 PsF
1280×720 HD	YCbCr(422) 10bit	60/59.94/50/30/29.97/25/24/23.98 P

*1 You also need the SER28.

- Video - Bit per Pixel(BPP)

Sets the number of bits per pixel (BPP) when Type is ST2110 JXS. The Ratio on the right shows the compression ratio calculated from the BPP.

Uncompressed, there are 20 bits per pixel, so if you set BPP to 5.0, for example, you get 4x compression. The smaller the BPP, the higher the compression.

Note that if the BPP is reduced, the borders of the image may become blurred.

0.5 - <u>4.0</u> - 10.0	(When System is 1280×720)
0.5 - <u>4.0</u> - 8.0	(When System is 1920×1080)
0.5 - <u>4.0</u>	(When System is 3840×2160)

- Video - Pattern

Select the output pattern. The selectable patterns are shown below. The selectable patterns vary depending on the System setting.

Depending on the pattern, you can turn on and off YCbCr separately.

Table 7-8 Output pattern selection

Pattern	YCbCr on/off
COLOR BAR 100%	Yes
COLOR BAR 75%	Yes
MULTI COLOR BAR 100%	Yes
MULTI COLOR BAR 75%	Yes
MULTI COLOR BAR (+I)	Yes
LIP SYNC (SER03)	No

- * The signal will be interrupted when the pattern is changed.
- * Bandwidth limit is not applied to patterns other than COLOR BAR 100% and COLOR BAR 75%.
- * When the time is PTP synchronized, the SMPTE ST 2110 LIP SYNC pattern is output the video and audio with 0 ms delay.

7. SYSTEM SETTINGS

- Video - Scroll

Select the scroll direction for when a pattern is scrolled.

If a setting other than OFF is selected, Moving Box and Phase Difference are turned off.

OFF

RIGHT: Scrolls from left to right.

LEFT: Scrolls from right to left.

UP: Scrolls from bottom to top.

DOWN: Scrolls from top to bottom.

RIGHT & UP: Scrolls from lower left to upper right.

RIGHT & DOWN: Scrolls from upper left to lower right.

LEFT & UP: Scrolls from lower right to upper left.

LEFT & DOWN: Scrolls from upper right to lower left.

- Video - Scroll - Speed

When Scroll is not set to off, set the scroll speed.

4 - 124 Dot (4 dot steps)

- Video - Moving Box

If you select the color of the moving box, a square that moves randomly is superimposed.

If a setting other than OFF is selected, Scroll is turned off.

OFF / WHITE / YELLOW / CYAN / GREEN / BLUE / RED / MAGENTA / BLACK

- Video - Moving Box - Speed

When Moving Box is not set to off, set the moving box speed.

Greater the value, higher the speed.

1 - 3

- Video - Character

Turns character superimposition on and off.

OFF / ON

- Audio - Mode

Select the audio standard.

Fixed to ST2110-30

- Audio - Packet Time

Select the audio packet time.

1ms / 125us

7. SYSTEM SETTINGS

- Audio - Channel Number

Select the number of channels.

Fixed to 8

- ANC - Data

Select the ancillary data.

Fixed to Payload ID

7.1.15 Setting the IP TSG Characters (SER32)

When the Character (IP TSG SETUP1 tab) is set to ON, use the IP TSG SETUP1-2 tab to configure the character settings.

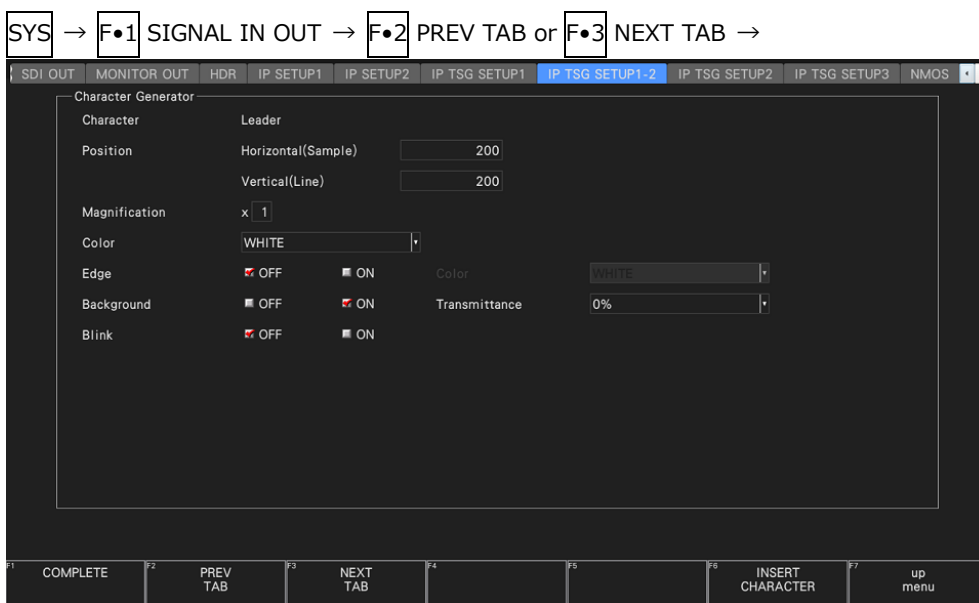

Figure 7-19 IP TSG SETUP1-2 tab

7. SYSTEM SETTINGS

- Character

Set the characters to be superimposed.

The default character is Leader, but you can change it using **F•6** INSERT CHARACTER.

Enter up to 20 characters.

You can use the following keys on the comment input screen.

F•1	CLEAR ALL	Deletes all characters
F•2	DELETE	Deletes the character at the cursor
F•3	INSERT	Inserts the selected character at the cursor position
F•4	<=	Moves the cursor to the left
F•5	=>	Moves the cursor to the right
F•6	CHAR SET	Enters the character
Function dial (F•D)		Turn to select a character, and press to enter the character.



Figure 7-20 Comment input screen

- Position – Horizontal(Sample)

Sets the horizontal (sample) position of the characters.

-
- 0 - 200 - 1279 (1280x720)
 - 0 - 200 - 1919 (1920x1080)
 - 0 - 200 - 3838 (3840x2160, 2 sample steps)
-

- Position – Vertical(Line)

Sets the vertical (line) position of the characters.

-
- 0 - 200 - 719 (1280x720)
 - 0 - 200 - 1079 (1920x1080)
 - 0 - 200 - 2158 (3840x2160, 2 line steps)
-

7. SYSTEM SETTINGS

- Magnification

Sets the magnification of characters.

1 - 4

- Color

Select the color of the characters.

WHITE / YELLOW / CYAN / GREEN / BLUE / RED / MAGENTA / BLACK

- Edge

Turns character borders on and off.

OFF / ON

Select the border color with Color when Edge is ON.

WHITE / YELLOW / CYAN / GREEN / BLUE / RED / MAGENTA / BLACK

- Background

Turns the character background (black) on and off.

OFF / ON

Select the background transparency with Transmittance when Background is ON.

100% / 75% / 50% / 25% / 0%

- Blink

Turns character blinking on and off.

OFF / ON

7. SYSTEM SETTINGS

7.1.16 Setting the IP Parameters of the IP TSG Signal (SER32)

When Test Signal on the IP TSG SETUP1 tab is set to ON, use IP Setup on the IP TSG SETUP2 tab to set the IP parameters.



Figure 7-21 IP TSG SETUP2 tab

- RTP Payload Type

Set the video, audio, and ANC payload type.

The default video, audio, and ANC values are 96, 97, and 100, respectively.

When the IP TSG SETUP1 tab Type is ST2110 JXS, Video changes to Video(JXS) and its default is 101.

96 - 127

- VLAN Tag

Set whether to include the VLAN tag.

OFF / ON

- VLAN Tag – Video, Audio, ANC

Set the video, audio, and ANC VLAN id (TCI).

1 - 4094

- DSCP Tag

Select whether to use DSCP.

OFF / ON

7. SYSTEM SETTINGS

- DSCP Tag – Video, Audio, ANC

Set the video, audio, and ANC DSCP.

0 - 63

- IP Output Port

Select which IP output you want to configure. You can set the following parameters for each IP report.

You can select 2 when Redundancy Mode on the IP TSG SETUP1 tab is set to ON.

1 / 2

- IP Output Port – Video, Audio, ANC

For the signal selected with IP Output Port, turn on or off the video, audio, and ANC. When Type is set to ST2022-6, set only for Video.

OFF / ON

- IP Output Port - Destination Address, Destination Port

For the signal selected with IP Output Port, set the destination IP address and port number.

When Type is set to ST2022-6, set only for Video.

The default values are as follows:

IP Output Port = 1

Video: 239.0.0.1 / 05000

Audio: 239.0.2.1 / 05000

Video: 239.0.3.1 / 05000

IP Output Port = 2

Video: 239.0.10.1 / 05000

Audio: 239.0.20.1 / 05000

Video: 239.0.30.1 / 05000

7. SYSTEM SETTINGS

7.1.17 Setting the IP TSG Packet Emulation (SER32)

Use Emulation Setup on the IP TSG SETUP3 tab to configure the IP TSG packet emulation settings.

The IP TSG packet emulation is enabled when IP Setup Type is set to ST2110 TSG on the IP SETUP1 tab.

When the IP TSG packet emulation is enabled, the IP signal video, audio and ANC cannot be decoded.

The packet error and jitter are complied with SMPTE ST 2110-20 (video signal), and inserted into the port 1 output.

The jitter value may be off by $\pm 10\%$.



Figure 7-22 IP TSG SETUP3 tab

- Emulation

Fixed to Test Signal

- Error

Generates the checksum error.

<u>OFF</u> :	Does not generate the checksum error.
<u>ON</u> :	Generates the checksum error. When set to on, select the error type below.
<u>FCS</u> :	Adds MAC frame checksum error
<u>IP CS</u> :	Adds IP checksum error
<u>UDP CS</u> :	Adds UDP checksum error

7. SYSTEM SETTINGS

- Jitter

Generates fluctuations to the packet transmission intervals.

<u>OFF</u> :	Does not generate the jitter.
<u>ON</u> :	Generates the jitter.
	When set to on, select the maximum fluctuation width below.
<u>Max</u> :	1 packet, 10 packet, 20 packet, 30 packet, 40 packet, 50 packet, 60 packet, 70 packet, 80 packet, 90 packet, 100 packet (In outputting 4K signal, you can set up to 20 packets.)

7.1.18 Configuring the NMOS Settings (SER05/SER06)

Use NMOS tab to configure the NMOS parameters.

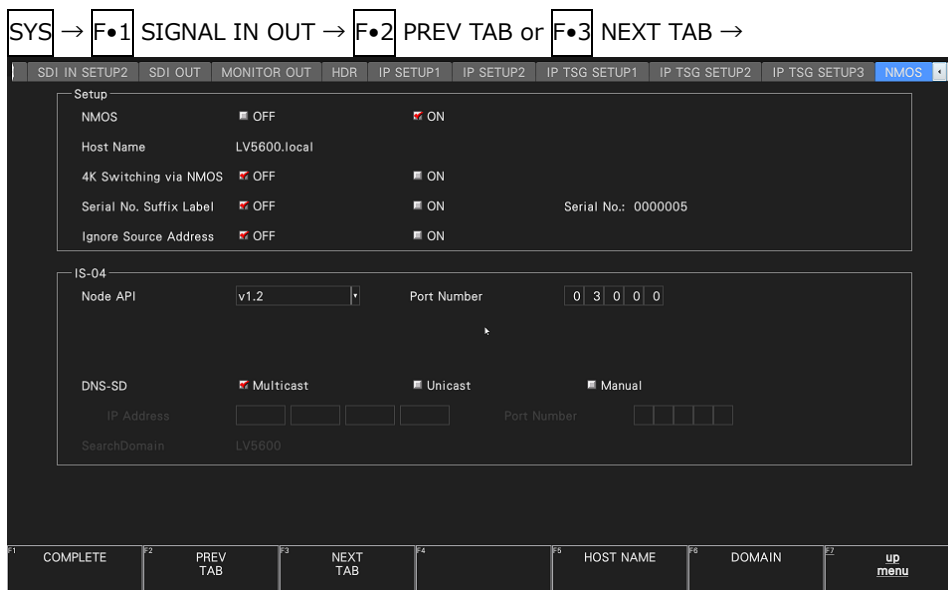

Figure 7-23 NMOS tab (SER06)

- NMOS

When set to on, registration control becomes possible using NMOS.

OFF / ON

- Host Name

Displays the NMOS host name.

The default NMOS host name is LV5600 or LV7600, but you can change it using **F•5** HOST NAME. Enter up to 16 characters.

7. SYSTEM SETTINGS

The key operations that you can perform in the host name input display are as follows:

F•1	CLEAR ALL	Deletes all characters
F•2	DELETE	Deletes the character at the cursor
F•3	INSERT	Inserts the selected character at the cursor position
F•4	<=	Moves the cursor to the left
F•5	=>	Moves the cursor to the right
F•6	CHAR SET	Enters the character
Function dial (F•D)		Turn to select a character, and press to enter the character.

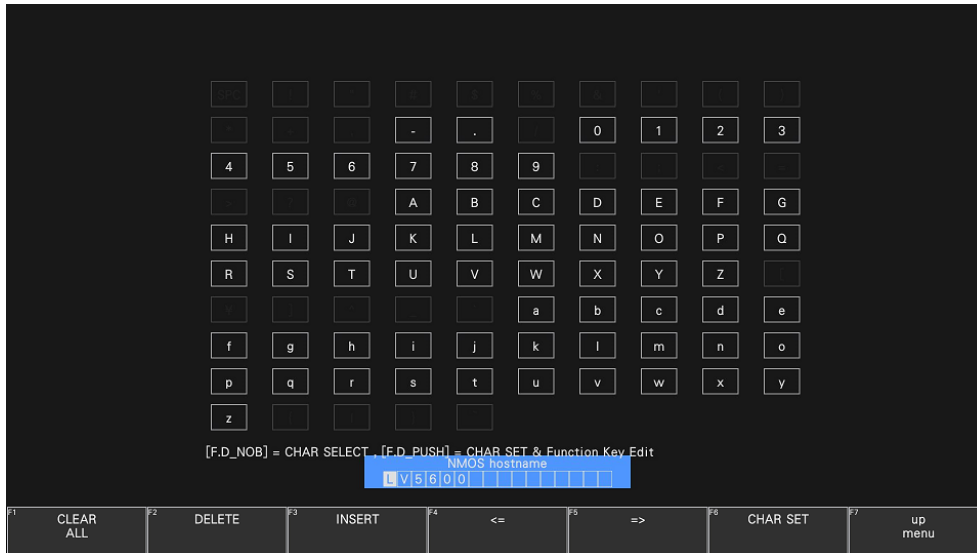

Figure 7-24 Host name input screen

- 4K Switching via NMOS (SER06)

When set to on, allows switching between 4K and 2K from NMOS.

OFF / ON

- Serial No. Suffix Label

When set on, add the SER05/SER06 serial number on NMOS each node label.

OFF / ON

- Serial No.

Displays the SER05/SER06 serial number.

7. SYSTEM SETTINGS

- Ignore Source Address

Select the Source Address operation when switching using NMOS.

<u>OFF:</u>	Updates its own settings based on the address information received by the LV5600/7600. The Destination Address, Destination Port, and Source Address values on the IP SETUP 1 tab are all updated and the checkboxes are checked.
<u>ON:</u>	Updates its own settings based on the address information received by the LV5600/7600, but ignores the Source Address. The Destination Address and Destination Port values on the IP SETUP 1 tab are updated and the checkbox is checked, but the Source Address value is not updated and the checkbox is unchecked.

- Node API

Select the Node API version of IS-04.

v1.2 / v1.3

- Port Number

Set the port number.

03000

- DNS-SD

Switches the DNS Service Discovery (DNS-SD) method for the Registry & Discovery System (RDS) detection of NMOS.

Attempts RDS detection using Multicast, Unicast, or Manual.

Before selecting Unicast, set DNS on the NETWORK tab of the SYS menu.

[See also] DNS → 7.2.6, "Setting the Network IP."

Multicast / Unicast / Manual

- IP Address

Set the IP address when Manual is selected in DNS-SD.

- Port Number

Set the port number when Unicast or Manual is selected in DNS-SD.

7. SYSTEM SETTINGS

- SearchDomain

Displays the NMOS domain name, when Unicast is selected in DNS-SD.

The default NMOS domain name is LV5600 or LV7600, but you can change it using **F•6** DOMAIN. Enter up to 16 characters.

The key operations that you can perform in the domain name input display are as follows:

F•1	CLEAR ALL	Deletes all characters
F•2	DELETE	Deletes the character at the cursor
F•3	INSERT	Inserts the selected character at the cursor position
F•4	<=	Moves the cursor to the left
F•5	=>	Moves the cursor to the right
F•6	CHAR SET	Enters the character

Function dial (F•D) Turn to select a character, and press to enter the character.

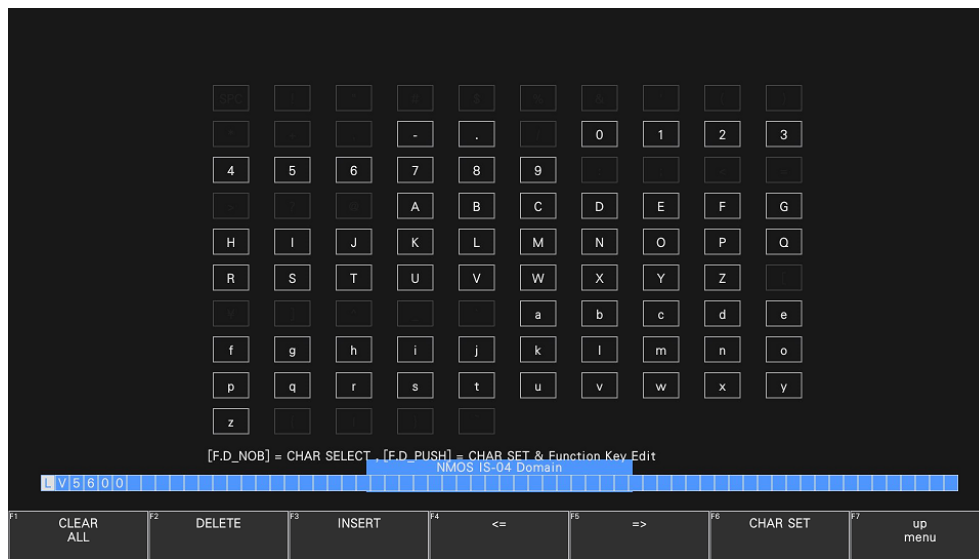

Figure 7-25 Domain name input screen

7. SYSTEM SETTINGS

7.2 Configuring the Instrument

To configure the instrument, press **F•2** SYSTEM SETUP on the SYS menu.

7.2.1 General Settings

Use General on the GENERAL tab to configure general settings of the instrument. They are not reset even if you initialize the settings. In addition, they are not recorded to presets.

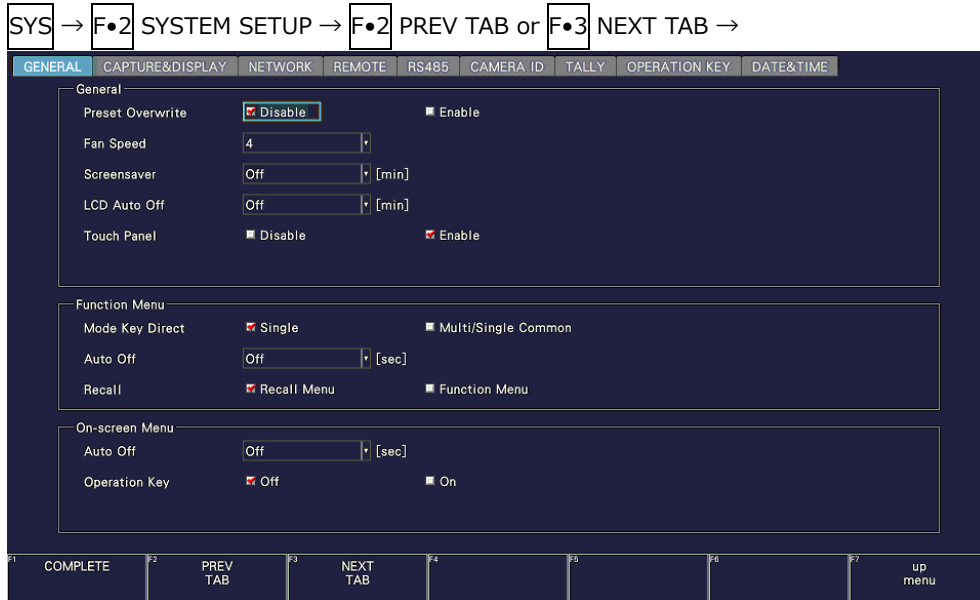

Figure 7-26 GENERAL tab

- Preset Overwrite

Select whether to enable overwriting when registering presets.
Disable this to prevent overwriting presets.

Disable / Enable

- Fan Speed

Select the fan speed.

The larger the value, the higher the speed and the higher the cooling capability. In contrast, the smaller the value, the quieter the fan noise.

The settings that you specify here will not be initialized even if you initialize the instrument. In addition, they are not recorded to presets.

When an SER02/SER02A, an SER05 or an SER06 is installed

4 / 5 / 6 / 7 / 8

When an SER02/SER02A and an SER05, or an SER06 is not installed

1 / 2 / 3 / 4 / 5 / 6 / 7 / 8

7. SYSTEM SETTINGS

- Screensaver

Select the length of time that must elapse without any key operations for the screen saver to start.

To clear the screen saver, press any key excluding the power switch, double-click, or operate the touch panel.

Off / 1 / 5 / 10 / 20 / 30 / 60 [min]

- LCD Auto Off (LV5600)

Select the length of time that must elapse after the last key operation before the backlight is automatically turned off.

To turn it on again, press any key excluding the power switch, double-click, or operate the touch panel.

Off / 5 / 30 / 60 [min]

- Touch Panel (LV5600)

Select whether to enable the touch panel function.

Disable / Enable

7.2.2 Configuring the Function Menu

Use Function Menu on the GENERAL tab to configure the function menu.

SYS → F•2 SYSTEM SETUP → F•2 PREV TAB or F•3 NEXT TAB →

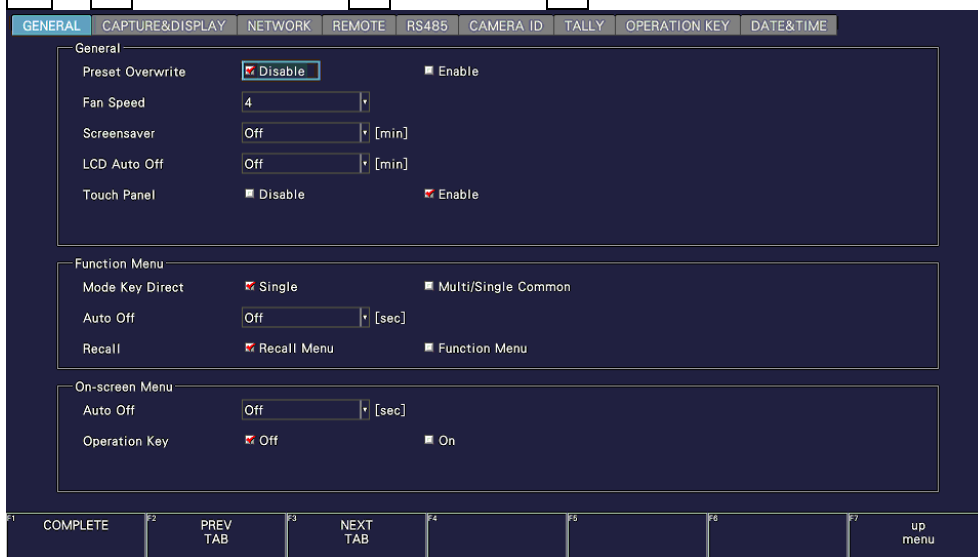

Figure 7-27 GENERAL tab

7. SYSTEM SETTINGS

- Mode Key Direct

In multi-screen display, you can select whether to switch the measurement screen with the mode keys (WFM, VECT, PIC, AUDIO, STATUS, and EYE).

Single:	Using the mode key switches the function menu and measurement screen.
<u>Multi/Single Common</u> :	Using the mode key switches only the function menu. The measurement screen does not change from the multi-screen display. To display the function menu on the multi-screen display, hold down MULTI for about 2 seconds.

- Auto Off

Set the length of time that must elapse without any key operations for the function menu to disappear automatically.

If set to off, the menu will not disappear automatically, but for example, the measurement menu can be temporarily hidden by pressing the MODE key again.

Even if set to a value other than off, some menus, such as the SYS menu, never automatically disappear.

Off / 1 / 2 / 3 / 4 / 5 / 10 / 20 / 30 / 60 [sec]

- Recall

Select the menu to be displayed when recalling presets.

<u>Recall Menu</u> :	The Recall menu is displayed.
<u>Function Menu</u> :	The measurement menu is displayed.

7.2.3 Configuring the On-screen Menu

Use On-screen Menu on the GENERAL tab to configure the on-screen menu.

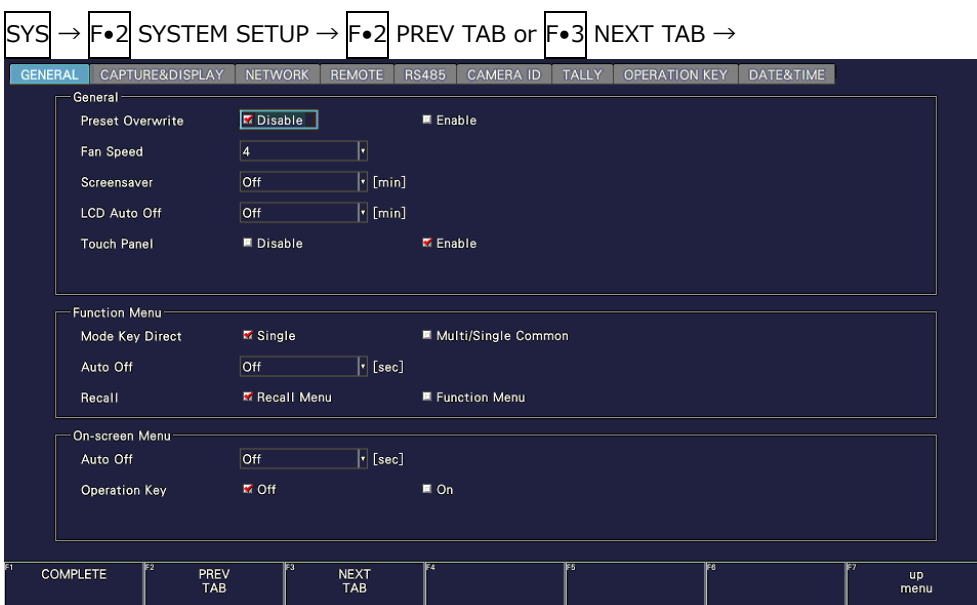

Figure 7-28 GENERAL tab

7. SYSTEM SETTINGS

- Auto Off

For keys on the screen controlled with the mouse or touch panel, select the length of time that must elapse without any key operations for the keys to disappear automatically.

Off / 1 / 2 / 3 / 4 / 5 / 10 / 20 / 30 / 60 [sec]

- Operation Key

Set whether to include the operation key in the keys on the screen controlled with the mouse or touch panel.

Off / On

7.2.4 Configuring the Capture Feature

Use Capture on the CAPTURE & DISPLAY tab to configure the capture feature.

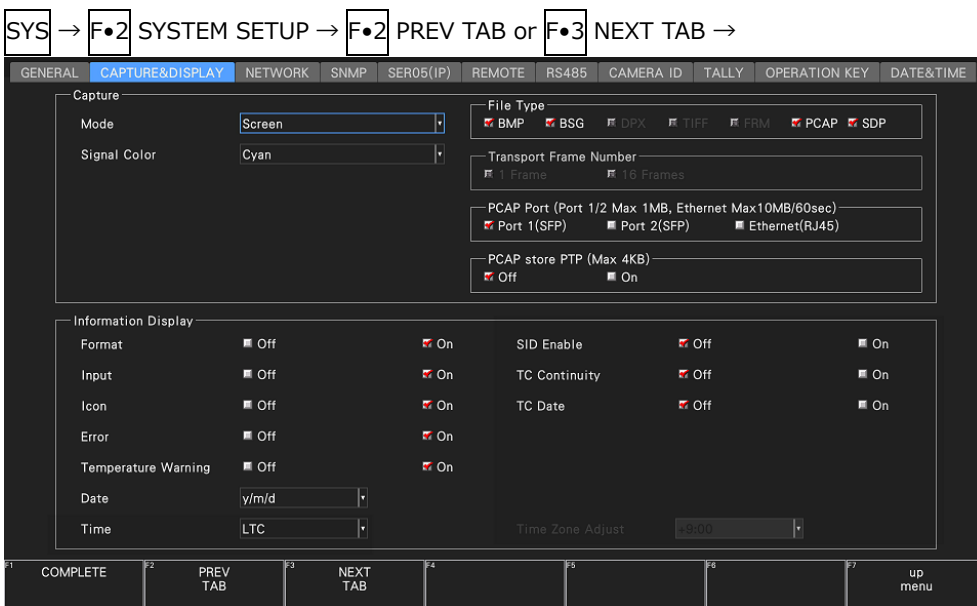

Figure 7-29 CAPTURE & DISPLAY tab

- Mode

Select the capture mode for when you press CAP.

[See also] 8, "CAPTURE FEATURE"

Screen:	The screen will be captured as still images.
Video Frame (SDI Code Value):	Frame data will be captured.
Video Frame (Converted):	Frame data will be captured.
	When data is saved to DPX or TIFF format, frame data is captured with the black level offset to zero.

- Signal Color

Select the capture waveform color.

White / Yellow / Cyan / Green / Magenta / Red / Blue

7. SYSTEM SETTINGS

- File Type

Turns on the file format for saving the captured screen or frame data to a USB memory device.

[See also] 8, "CAPTURE FEATURE"

Mode = Screen

BMP:	Files are saved to a USB memory device in BMP format. You can view the saved files on a PC.
BSG:	Files are saved to a USB memory device in BSG format. You can view the saved files on the instrument.
PCAP:	Files are saved to a USB memory device in PCAP format. (*1)
SDP:	The SDP file set by NMOS is saved in a USB memory device. (*1)

* By default, BMP and BSG are both on. You cannot set both of these settings to OFF. The default PCAP and SDP values are off.

*1 Only SER05 or SER06

Mode = Video Frame (SDI Code Value) or Video Frame (Converted)

DPX:	Only the picture area is saved as 10-bit DPX files. Even when the input signal is 12 bits, it is rounded to 10 bits and saved. When Mode is set to video Frame (Converted), the black level is offset to zero. This cannot be selected when Frame Number is set to 16 Frames.
TIF:	Only picture data is saved as TIFF files. This data is DPX data converted into TIFF format. When Mode is set to video Frame (Converted), the black level is offset to zero. This cannot be selected when Frame Number is set to 16 Frames.
FRM:	frame data is saved.
SDP:	The SDP file set by NMOS is saved in a USB memory device. (*1)

* By default, all the check boxes are selected. You cannot turn all the settings off.

*1 Only SER05 or SER06

- Transport Frame Number

When Mode is set to Video Frame (SDI Code Value) or Video Frame (Converted), select the number of frames to capture.

[See also] 8.2, "Frame Capture"

1 Frame:	A single frame of data is saved.
16 Frames:	16 consecutive frames of data are saved. For the following formats, 32 picture frames are captured because two picture frames are mapped to each frame. <ul style="list-style-type: none">• 3G-B-DL transmission; 3G(QL), 3G(DL)-2K frame rate 60P/59.94P/50P/48P/47.95P• HD(DL) transmission; frame rate 60P/59.94P/50P/48P/47.95P

7. SYSTEM SETTINGS

- PCAP Port

When set on, packets are captured from the selected IP or Ethernet port and saved in PCAP format.

- PCAP store PTP

When set on, packets with only PTP are captured and saved.

When PCAP Port is set to Ethernet, You cannot select.

7.2.5 Configuring the Information Display

Use Information Display on the CAPTURE & DISPLAY tab to configure the information display.

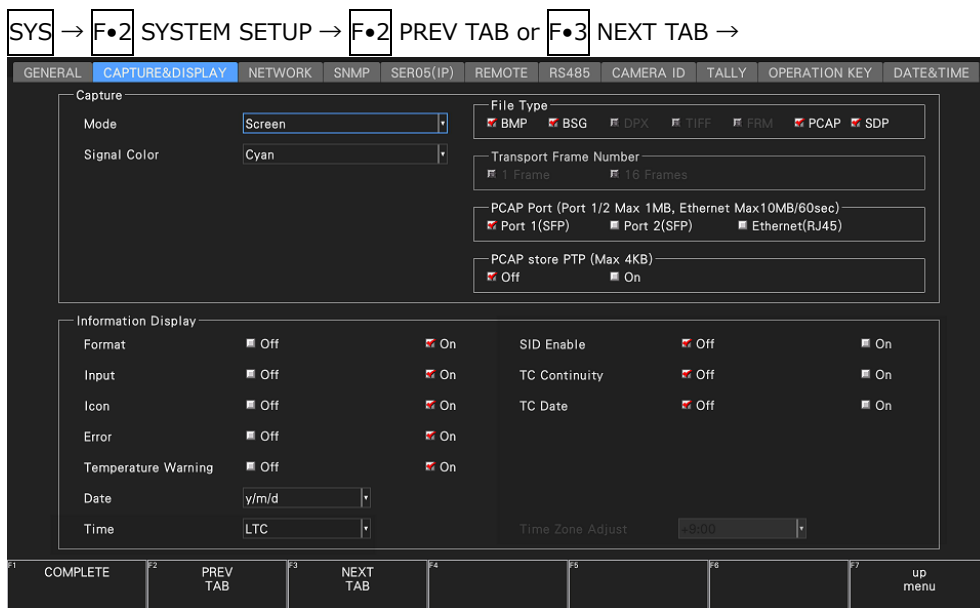

Figure 7-30 CAPTURE & DISPLAY tab

- Format

Turns on and off the format display (e.g., 1920x1080/59.94I YCbCr(422) 10bit HD). This setting is valid when a FORMAT item or Format option is placed in the layout.

Off / On



- Input

Turns on and off the input signal display (e.g., SDI A).

This setting is valid when an INPUT item or Input option is placed in the layout.

Off / On

- Icon

Turns on and off the mouse icon , key lock icon , and USB memory icon .

If you turn this off, you will not be able to tell from the screen whether a mouse, the US interface of a touch panel monitor, or a USB memory device is connected.

[See also] 5.9, "Measurement Screen Description"

Off / On

7. SYSTEM SETTINGS

- Temperature Warning

Turns on and off the alarm display (TEMPERATURE) that appears when the internal temperature increases.

“OVER HEAT” will still be displayed even if this is set to off.

[See also] 7.3, “Displaying System Information”

Off / On

- Error

Turn on or off the error display in the upper right of the measurement screen.

[See also] 5.9, “Measurement Screen Description”

Off / On

- Date

Select the display format of the date. y is the Gregorian year, m is the month, and d is the day.

This setting is valid when a DATE item is placed in the layout or when TC Date is set to On.

Off / y/m/d / m/d/y / d/m/y

- Time

Select the display format of the time.

This setting is valid when a TIME item or Time option is placed in the layout, in the clear screen log of the picture display, and in the event log of the status display.

When PTP is selected, set the correction time in Time Zone Adjust.

Off / Real Time / LTC / VITC / D-VITC / PTP

- SID Enable

Set source ID display on or off.

When set to On, displays the source ID in the TIME item area or Time option area of the layout. The source ID is the UDW 15 word of ancillary data transmitted with DID: 253h and SDID: 149h, displayed in ASCII code.

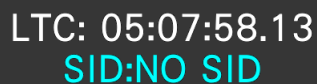

LTC: 05:07:58.13
SID:NO SID

Off / On

7. SYSTEM SETTINGS

- TC Continuity

Set the time code continuity error detection on or off when Time is LTC or VITC.

When set to On, error detection results are displayed in the TIME item area or Time option area of the layout, and errors are detected in the event log.

[See also] 16.4, "Configuring Event Log Settings"

Error detection results are displayed as follows depending on the timecode status.

Status	TIME item Time option	Event Log
Timecode is normal	TC:OK	-
Missing timecode packet (*1)	TC:ERR	TC NO
Duplicate timecode	TC:ERR	TC RPT
Timecode is discontinuous (*2)	TC:ERR	TC SKIP

*1 The time display will be "LTC --:--:--:--" or "VITC --:--:--:--".

*2 Discontinuity of drop frame flag is not detected.

The "TC:ERR" display will remain even if the time code returns to normal, so to clear the error, press **F•7** ERROR CLEAR on the status screen.

TC:OK LTC: 05:08:36.29

TC:ERR LTC: 23:59:56.13

Off / On

- TC Date

Set the time code date display on or off when Time is LTC or VITC.

When set to On, displays the timecode date in the TIME item area or Time option area of the layout. At this time, the DATE item in the layout will display the device date set on the DATE&TIME tab, not the timecode date.

TIME item (Timecode date)

30/11/06
LTC: 05:09:14.16

DATE item (Device date)

DATE: 2023/11/06

Off / On

7. SYSTEM SETTINGS

7.2.6 Setting the Network IP

Use IP on the NETWORK tab to configure network IP settings and view the MAC address. The settings that you specify here will not be initialized even if you initialize the instrument. In addition, they are not recorded to presets.



Figure 7-31 NETWORK tab

- DHCP

Select how to set the IP address.

<u>Off</u> :	Enter the IP address, subnet mask, and default gateway manually.
<u>On</u> :	The IP address, subnet mask, and default gateway are set automatically.

- IP Address

- Subnet Mask

- Default Gateway

- DNS

Set the IP address, subnet mask, default gateway, and DNS.

- MAC Address

Displays the MAC address.

7. SYSTEM SETTINGS

7.2.7 Configuring SNTP

Use SNTP on the NETWORK tab to configure the SNTP parameters.

The settings that you specify here will not be initialized even if you initialize the instrument.

In addition, they are not recorded to presets.

SYS → **F•2** SYSTEM SETUP → **F•2** PREV TAB or **F•3** NEXT TAB →

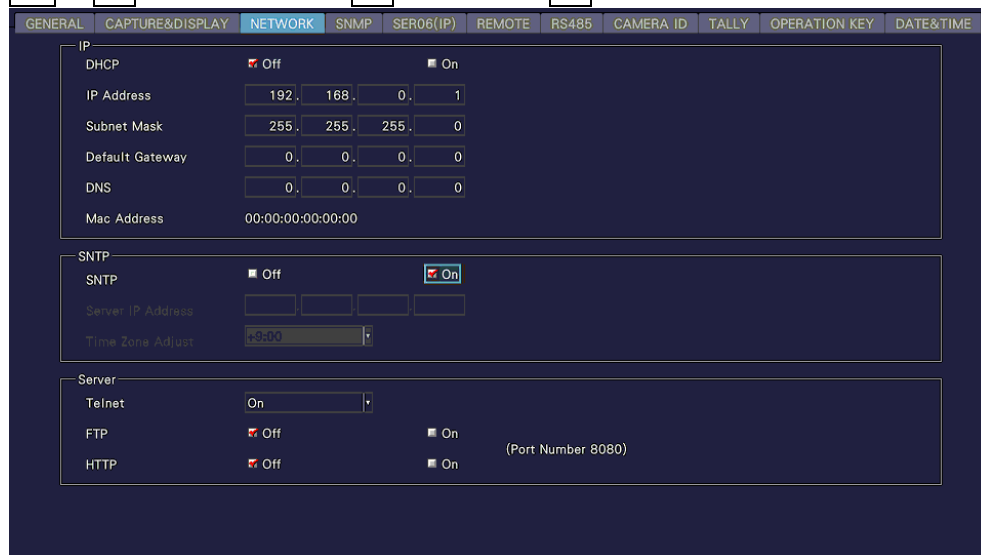

Figure 7-32 NETWORK tab

- SNTP

Select whether to enable the SNTP client function.

When set to On, enter the NTP server IP address in Server IP Address and the time adjustment value in Time Zone Adjust.

Off / On

- Server IP Address

- Time Zone Adjust

When the SNTP client function is set to ON, enter the NTP server IP address in Server IP Address and the time adjustment value in Time Zone Adjust.

7. SYSTEM SETTINGS

7.2.8 Configuring the Server

Use Server on the NETWORK tab to configure the TELNE, FTP, and HTTP. The settings that you specify here will not be initialized even if you initialize the instrument. In addition, they are not recorded to presets.

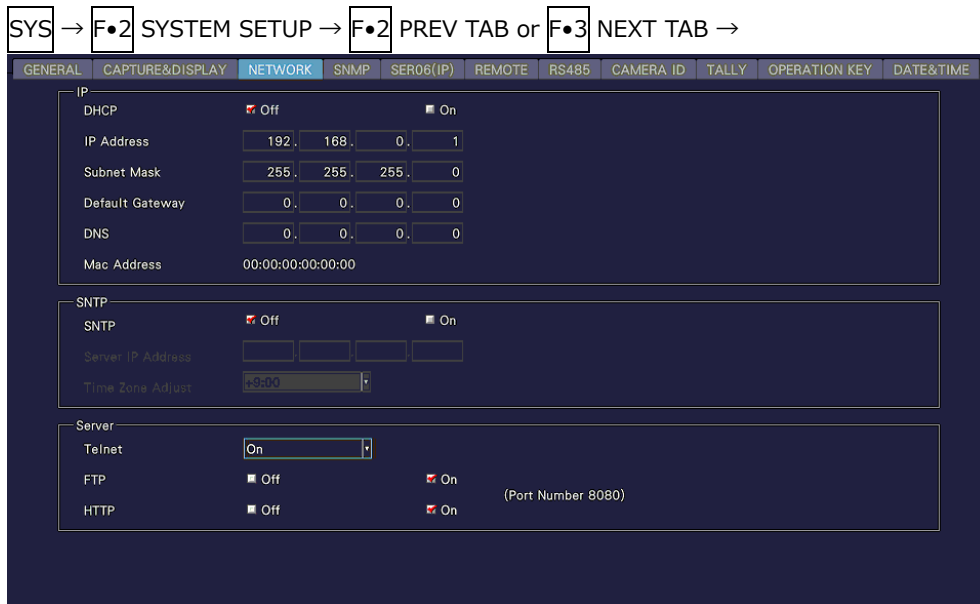

Figure 7-33 NETWORK tab

- Telnet

Select whether to enable the TELNET server feature and the LV7290 REMOTE CONTROLLER.

You cannot use TELNET and the LV7290 at the same time.

Off / On / LV7290

- FTP Server

Select whether to enable the FTP server function.

Off / On

- HTTP Server

Select whether to enable the HTTP server feature.

Off / On

7. SYSTEM SETTINGS

7.2.9 Configuring SNMP

Use SNTP tab to configure the SNTP parameters.

The settings that you specify here will not be initialized even if you initialize the instrument. Nor are they recorded to presets.

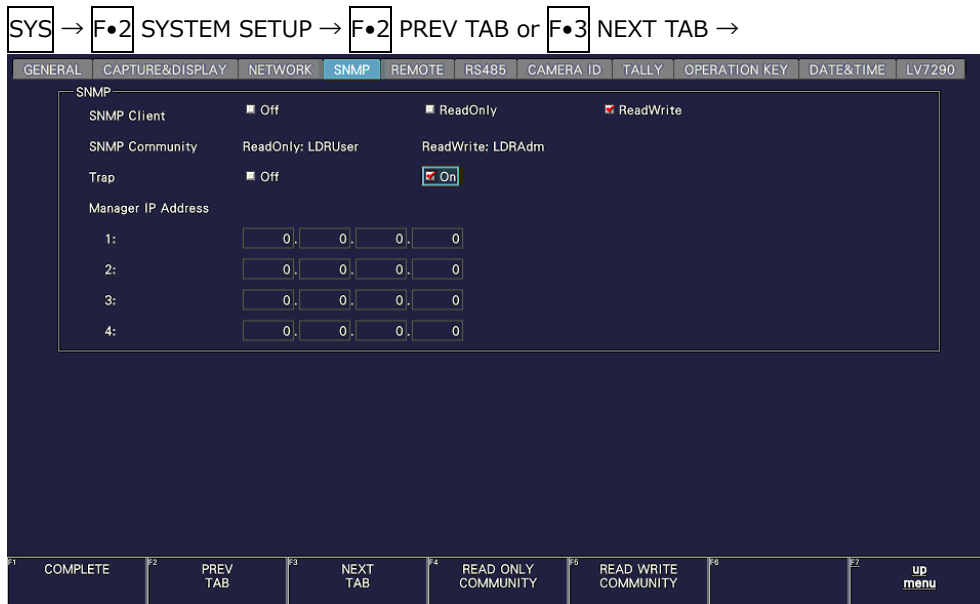

Figure 7-34 SNMP tab

- **SNMP Client**

Select the SNMP access mode.

<u>Off</u> :	SNMP cannot be used.
<u>ReadOnly</u> :	Settings can be read.
<u>ReadWrite</u> :	Settings can be read and written.

- **SNMP Community**

Shows the SNMP community name.

The default values are shown below. You can change them using F•4 READ ONLY COMMUNITY and F•5 READ WRITE COMMUNITY. You cannot change the community name of TRAP.

Enter a comment using up to 15 characters.

Default

ReadOnly:	LDRUser
ReadWrite:	LDRAdm
TRAP:	LDRUser

You can use the following keys on the SNMP community name input screen.

F•1	CLEAR ALL	Deletes all characters
F•2	DELETE	Deletes the character at the cursor
F•3	INSERT	Inserts the selected character at the cursor position
F•4	<=	Moves the cursor to the left
F•5	=>	Moves the cursor to the right
F•6	CHAR SET	Enters the character

7. SYSTEM SETTINGS

Function dial (F•D)

Turn to select a character, and press to enter the character.



Figure 7-35 Community name input screen

- Trap

Select whether to enable SNMP trap output.

Off / On

- Manager IP Address

Shows up to four SNMP manager IP addresses.

- Saving the enterprise MIB file to USB memory device

To save the enterprise MIB file to USB memory device, follow the procedure shown below.

1. Connect a USB memory device to the instrument.
2. Press **F•6** USB MEMORY.
3. Press **F•1** MIB FILE COPY.

The enterprise MIB file is saved to USB memory device.

Enterprise MIB file is saved to the following locations.

- 📁 USB memory device
 - └ 📁 LV5600_USER or LV7600_USER
 - └ 📁 MIB
 - └ 📄 lv5600.my or lv7600.my

When the enterprise MIB file exists in the USB memory device, **F•1** OVER WRITE YES and **F•3** OVER WRITE NO appear.

To overwrite, press **F•1** OVER WRITE YES. To not overwrite, press **F•3** OVER WRITE NO.

7. SYSTEM SETTINGS

7.2.10 Configuring the IP Settings (SER05/SER06)

Use SER05 on the SER05 (IP) tab or SER06 on the SER06 (IP) tab to configure network settings and view the MAC address for IP 1 and 2. For the SER06, also select the SFP module to use.

The settings that you specify here will not be initialized even if you initialize the instrument. Nor are they recorded to presets.

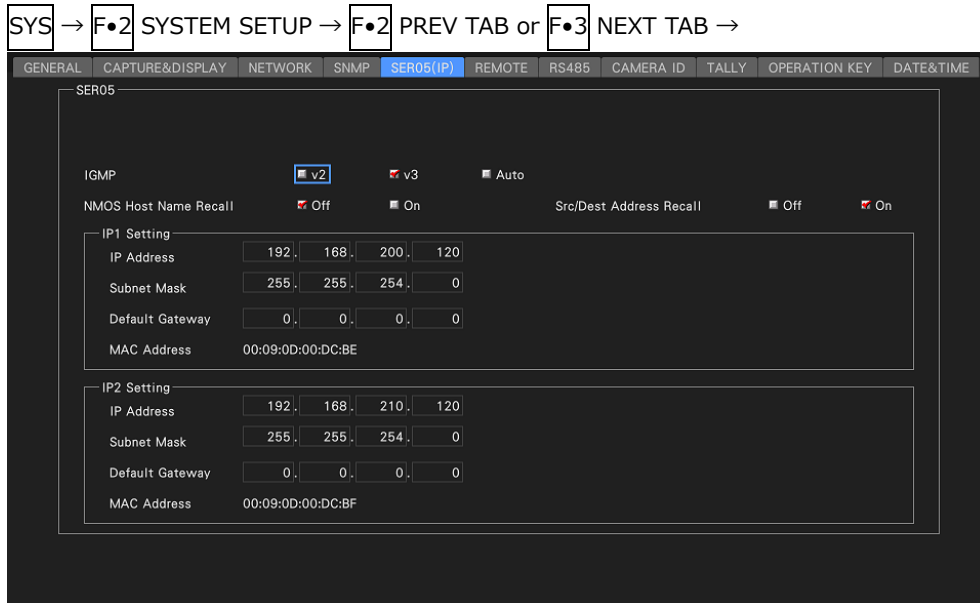

Figure 7-36 SER05 (IP) tab

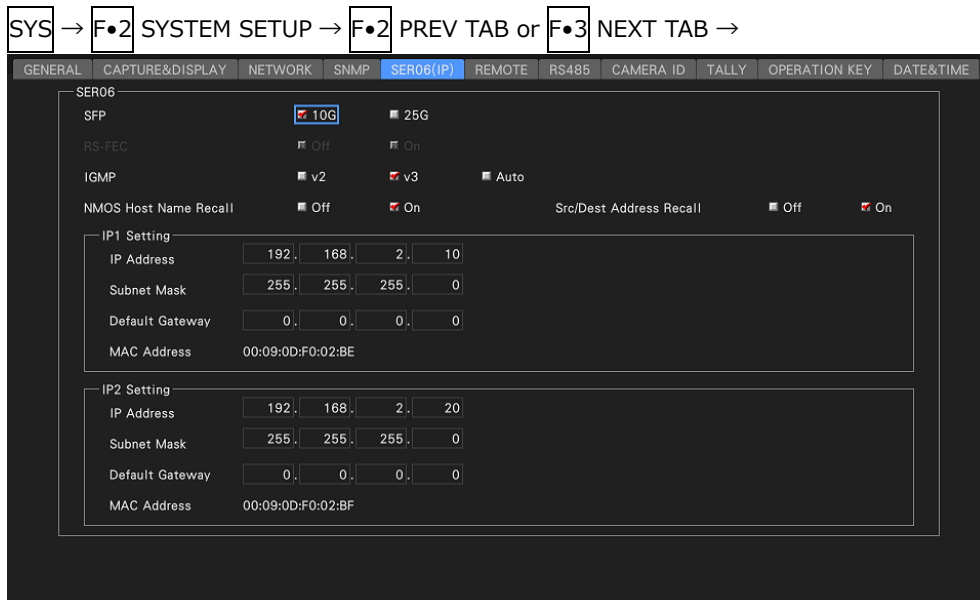

Figure 7-37 SER06 (IP) tab

7. SYSTEM SETTINGS

- SFP (SER06)

Select the SFP module you want to use. For the SFP+ module, select 10G. For the SFP28 module, select 25G.

10G / 25G

- RS-FEC (SER06)

Turns on and off the RS-FEC.

Off / On

- IGMP

Sets the IGMP version. You need to set the version according to the IP switch settings.

v2 / v3 / Auto

- NMOS Host Name Recall

Sets whether Host Name on the NMOS tab is subject to preset recall.
When it is set to on, it is subject to preset recall.

Off / On

- Src/Dest Address Recall

Sets whether or not the following items are subject to preset recall.
When it is set to on, it is subject to preset recall.

- Source Address, Destination Address, and Destination Port settings on the IP SETUP1 tab
- Video, Audio, and ANC settings on the IP TSG SETUP2 tab

Off / On

- IP Address

- Subnet Mask

- Default Gateway

Set the IP address, subnet mask, and default gateway.

- MAC Address

Displays the MAC address.

7. SYSTEM SETTINGS

7.2.11 Configuring the Remote Control Settings

Use the REMOTE tab to configure remote control settings.

The settings that you specify here will not be initialized even if you initialize the instrument.

In addition, they are not recorded to presets.

[See also] 10, "REMOTE CONTROL"

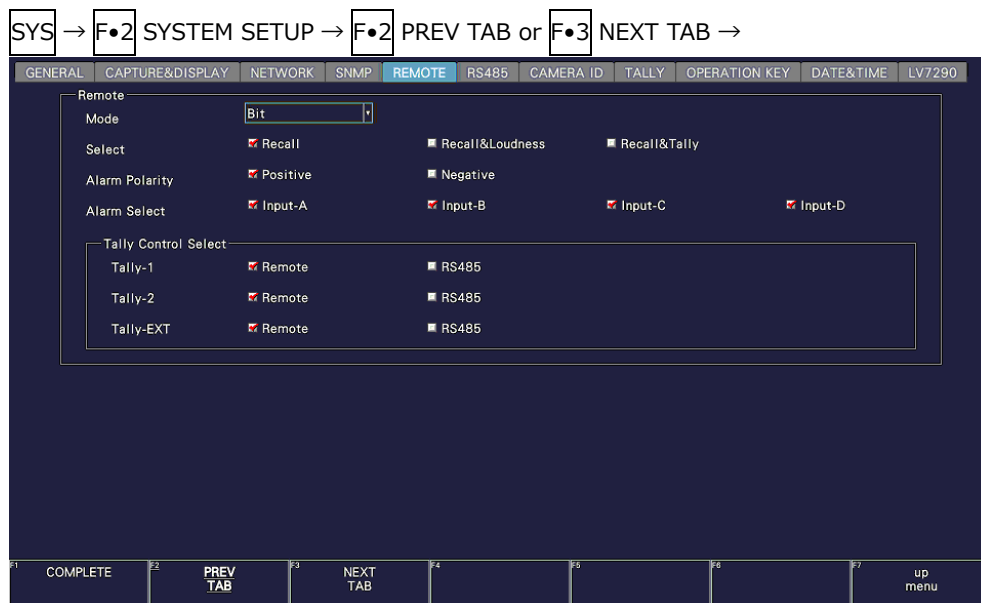

Figure 7-38 REMOTE tab

- Mode

Select the method for loading presets.

<u>Bit</u> :	Use pin 2 (/P1) to pin 9 (/P8) to load presets 1 to 8.
<u>Binary</u> :	Set pin 2 (/P1) as the least significant bit and pin 7 (/P6) as the most significant bit, and use binary code to load presets 1 to 60.
<u>Command</u> :	Recalls presets (1 to 60), selects channels, outputs alarms, and displays tallies (1/2).
<u>Tally</u> :	Outputs alarms and displays tallies (1/2/EXT). (SER27)

- Select (SER03/SER27)

When Mode is Bit or Binary, select the function to assign to pin 8 (/P7), pin 9 (/P8), pin 10 (/ACH), pin 11 (/BCH), pin 12 (/CCH), and pin 13 (/DCH) of the remote connector. When Mode is Command or Tally, select Recall.

This is displayed when SER03 or SER27 or both are installed.

<u>Recall</u> :	Assign preset recalling.
<u>Recall&Loudness</u> :	Assigned loudness control.
<u>Recall&Tally</u> :	Assigned tally control.

7. SYSTEM SETTINGS

- Alarm Polarity

Select the alarm output polarity.

Positive: A high signal is transmitted when an error is detected.

Negative: A low signal is transmitted when an error is detected.

- Alarm Select

Select the display channel that errors are detected on for transmitting alarms.

By default, all the check boxes are selected.

When measuring 3G-B DS, alarms are output only for the currently shown display channels.

Input-A / Input-B / Input-C / Input-D

- Tally-1

- Tally-2

- Tally-EXT

Select whether to control the tally using the remote connector or RS-422/485 connector (SER27).

Remote / RS485

7. SYSTEM SETTINGS

7.2.12 Configuring the RS-422/485 Settings (SER27)

Use the RS485 tab to configure the RS-422/485 settings.

The settings that you specify here (except Local ID Setting) will not be initialized even if you initialize the instrument. In addition, they are not recorded to presets.

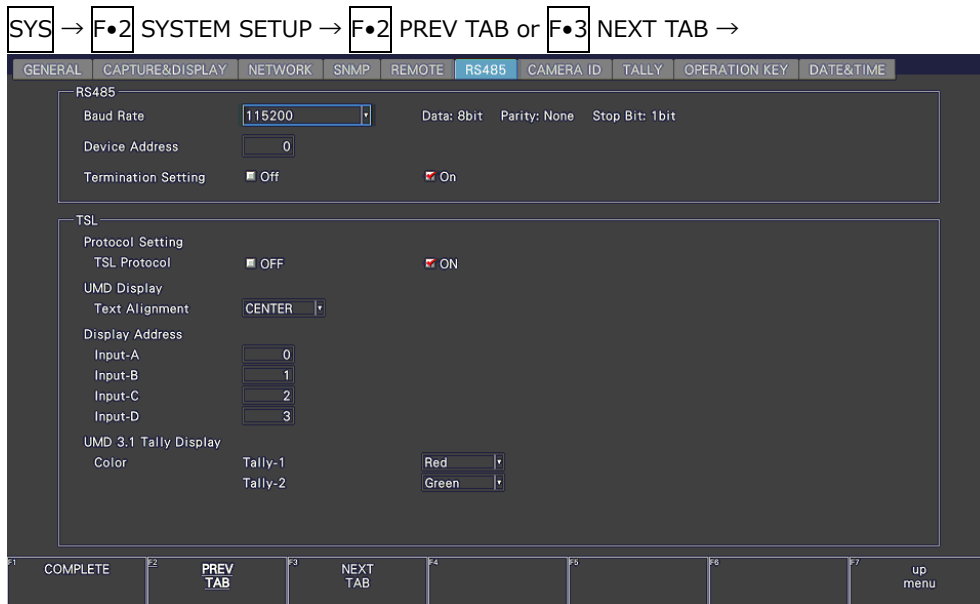

Figure 7-39 RS485 tab

- Baud Rate

Select the baud rate.

The following parameters are fixed: data length: 8 bit, parity: none, stop bit: 1 bit.

9600 / 19200 / 38400 / 57600 / 115200

- Device Address

Set the instrument's address. If you are connecting several instruments, assign different numbers.

0 - 99

- Termination Setting

Terminates the RS-422/485 connector. If you are connecting several instruments, set the instrument at the end to on and all others to off.

Off / On

- TSL Protocol

Select the control protocol for the RS-422/485 port. Set this to off when using the Leader's standard protocol. Set this to on when using the TSL protocol.

Off / On

7. SYSTEM SETTINGS

- Text Alignment

When using the TSL protocol, select the alignment of the camera IDLABEL-1 item placed in the layout.

LEFT / CENTER / RIGHT

- Display Address

When using the TSL protocol, set the display addresses of display channels A to D. The default values are 0 for Input-A, 1 for Input-B, 2 for Input-C, and 3 for Input-D.

0 to 126

- Color

When using the TSL protocol, set the colors of the TALLY-1 and TALLY-2 items placed in the layout for the UMD 3.1 operation.

The default values are red for Tally-1 and green for Tally-2.

Red / Green / Blue / Cyan / Magenta / Yellow / Orange

7.2.13 Setting the Camera ID (SER27)

When ID Control Select is set to Local, use the CAMERA ID tab to select the placement of the camera ID and set the label.

The procedures for Camera ID Label-1, Camera ID Label-2, and Camera ID Label-IRIS are the same.

The settings that you specify here (except the placement selection and label setting) will not be initialized even if you initialize the instrument. In addition, they are not recorded to presets.



Figure 7-40 CAMERA ID tab

7. SYSTEM SETTINGS

- Control Select

Select whether to set the camera ID on the instrument or through the RS-422/485 connector.

To camera ID is displayed for the LABEL-1, LABEL-2, and IRIS items on the layout.

Local / RS485

- Selecting the placement

Select the placement of the camera ID.

LEFT / CENTER / RIGHT

- Setting the label

The default camera ID labels are CAM A to CAM D, but you can change them by selecting their check boxes and pressing **F•5** LOCAL LABEL INPUT. Enter up to 16 characters.

You can use the following keys on the camera ID input screen.

F•1	CLEAR ALL	Deletes all characters
F•2	DELETE	Deletes the character at the cursor
F•3	INSERT	Inserts the selected character at the cursor position
F•4	<=	Moves the cursor to the left
F•5	=>	Moves the cursor to the right
F•6	CHAR SET	Enters the character
Function dial (F•D)		Turn to select a character, and press to enter the character.

The camera IDs can also be changed through RS-422/485. (When using this method, you can use Japanese Shift-JIS codes in addition to ASCII codes.)

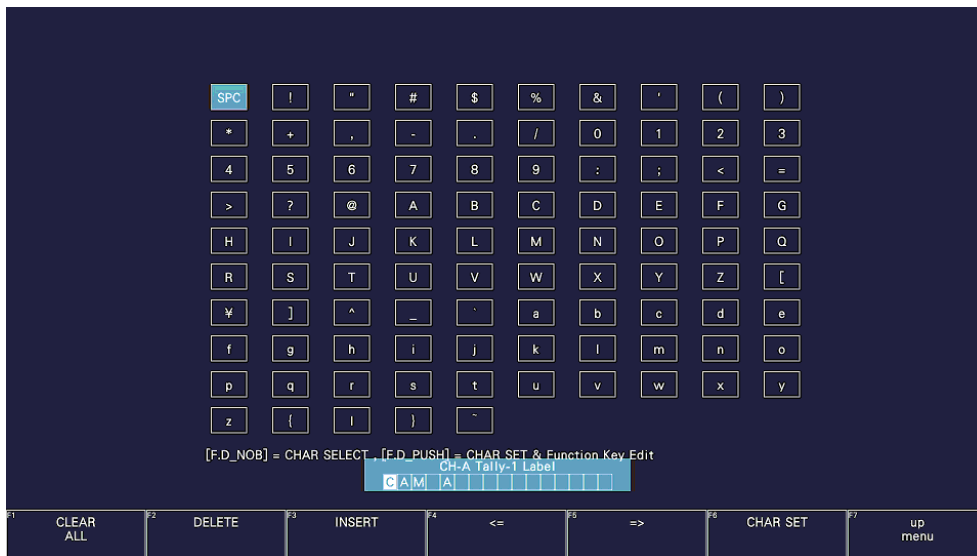

Figure 7-41 Camera ID label input screen

7. SYSTEM SETTINGS

7.2.14 Configuring the Tally Display (SER27)

Use the TALLY tab to configure the settings of the TALLY item placed in the layout.

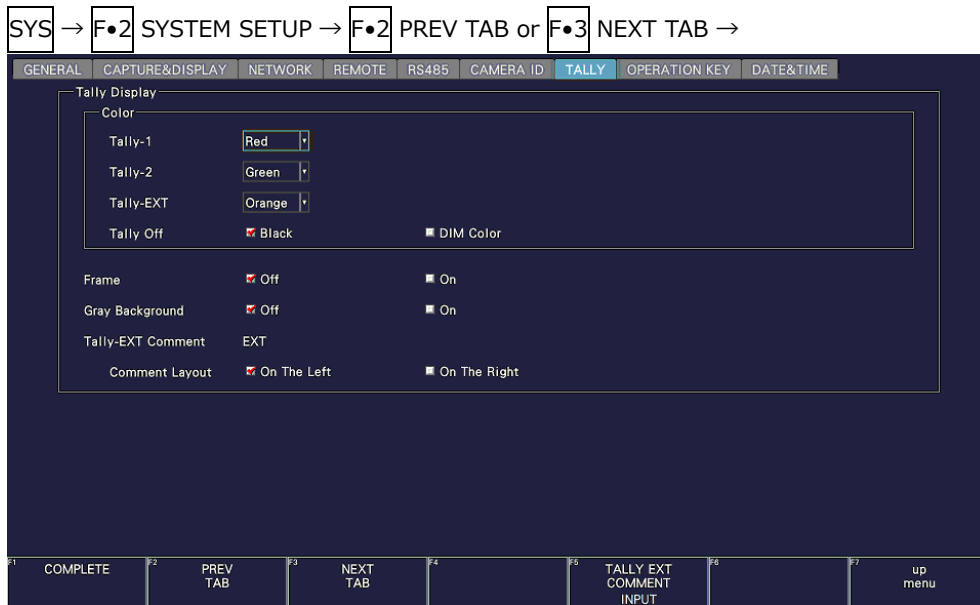

Figure 7-42 TALLY tab

- Tally-1, Tally-2, Tally-EXT

Select the color of the TALLY item placed in the layout. The default values are red for Tally-1, green for Tally-2, and orange for Tally-EXT.

Red / Green / Blue / Cyan / Magenta / Yellow / Orange

- Tally Off

Select the color of the TALLY item placed in the layout and that of the tally frame for when the tally is off.

Black: No color is displayed.
DIM COLOR: The selected color is displayed dimly.

- Frame

Turns on and off the frame of the LABEL-1, LABEL-2, IRIS, TALLY-1, and TALLY-2 items placed in the layout.
(The frame of the TALLY-EXT item is always shown.)

Off / On

- Gray Background

Select whether to display the background of the LABEL-1, LABEL-2, IRIS, and TALLY-EXT items placed in the layout in gray.

Off / On

7. SYSTEM SETTINGS

- Tally-EXT Comment

Displays the comment of the TALLY-EXT item placed in the layout.

The default value is EXT, but you can change it using **F•5** TALLY EXT COMMENT INPUT.

Enter a comment using up to eight characters.

You can use the following keys on the comment input screen.

F•1	CLEAR ALL	Deletes all characters
F•2	DELETE	Deletes the character at the cursor
F•3	INSERT	Inserts the selected character at the cursor position
F•4	<=	Moves the cursor to the left
F•5	=>	Moves the cursor to the right
F•6	CHAR SET	Enters the character
Function dial (F•D)		Turn to select a character, and press to enter the character.

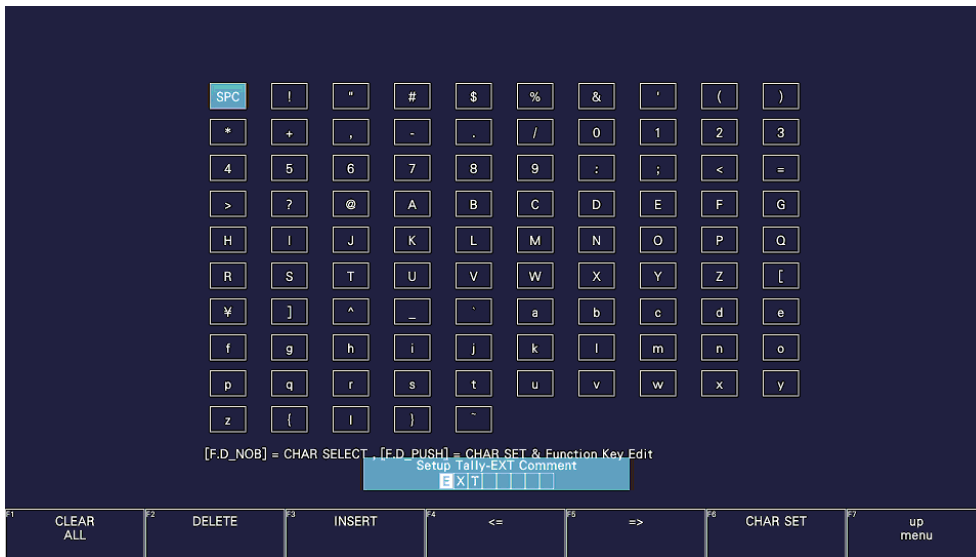

Figure 7-43 Comment input screen

- Comment Layout

Select the comment position of the TALLY-EXT item placed in the layout.

on the left: Places the comment on the left.

on the right: Places the comment on the right.

7. SYSTEM SETTINGS

7.2.15 Setting the Operation keys

Use the OPERATION KEY tab to set the operation keys.



Figure 7-44 OPERATION KEY tab

- FORM

Set the display format and display order to apply when the FORM key is pressed on the video signal waveform display or vector display. Select SKIP to skip an item.

WFM: Y / YCbCr / YGBR / GBR / YRGB / RGB / COMPOSITE / SKIP
 VECTOR: COMPONENT / COMPOSITE / SKIP

- SHORT CUT

Select the action to perform when the S-CUT key is pressed.

DIRECT: The previously registered panel settings will be loaded. To register the panel settings, configure the instrument to the settings that you want to register, press MEM, and then press SHORTCUT.

CAP&WAIT: A screen capture will be taken and saved to a USB memory device. Connect a USB memory device in advance.

INTENSITY: Use the function menu shown in the lower right of the screen to adjust the waveform intensity. This is valid on the video signal waveform display, vector display, and audio display (SER03). When a mouse is connected, clicking the function menu resets the value to the default. When using the touch panel, tapping the function menu resets the value to the default.

CURSOR: Performs cursor measurement. This is valid on the video signal waveform display and vector display.

VOLUME: Use the function menu shown in the lower right of the screen to adjust the headphone volume. When a mouse is connected, clicking the function menu resets the value to the default. When using the touch panel, tapping the function menu resets the value to the default.

7. SYSTEM SETTINGS

- FILTER

Set the filter and display order to apply when the FILTER key is pressed in the pseudo-composite display of the video signal waveform display. Select SKIP to skip an item. Note that for component display, the FILTER key is used to switch between FLAT and LOWPASS.

FLAT / LUM / FLAT+LUM / LUM+CRMA / SKIP

- MAG(GAIN)

Set the magnification and display order to apply when the MAG (GAIN) key is pressed on the video signal waveform display or vector display. Select SKIP to skip an item.

WFM: X1 / X5 0% / X5 10% / X5 20% / X5 30% / X5 40% / X5 50% / X5 60% / X5 70% / X5 80% / X5 90% / X5 100% / X10 0% / X10 10% / X10 20% / X10 30% / X10 40% / X10 50% / X10 60% / X10 70% / X10 80% / X10 90% / X10 100% / SKIP

VECTOR: X1 / X5 / IQ-MAG / SKIP

- SWEEP

Set the sweep method and display order to apply when the SWEEP key is pressed on the video signal waveform display. Select SKIP to skip an item.

1H / 2H / 1V / 2V / SKIP

- MAG(SWEEP)

Set the horizontal magnification and display order to apply when the MAG (SWEEP) key is pressed on the video signal waveform display. Select SKIP to skip an item.

X1 / X10 / X20 / X40 / ACTIVE / BLANK / SKIP

7. SYSTEM SETTINGS

7.2.16 Date and time settings

Use the DATE&TIME tab to set the date and time.

You cannot set these settings when the SNTP client function is set to on.

The settings that you specify here will not be initialized even if you initialize the instrument.

In addition, they are not recorded to presets.

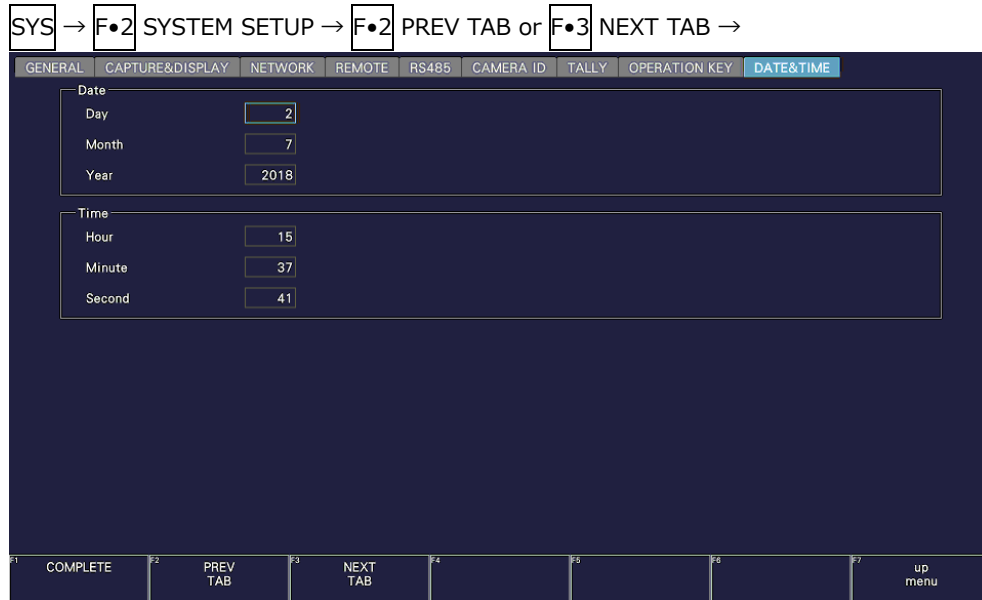

Figure 7-45 DATE & TIME tab

7. SYSTEM SETTINGS

7.2.17 Configuring the LV7290

You can configure the LV 7290 REMOTE CONTROLLER (sold separately) on the LV7290 SETUP tab.

If LV7290 is not selected under Telnet on the NETWORK tab, the LV7290 will not be displayed.

[See also] Telnet → 7.2.8, "Configuring the Server"

The connection to the LV7290 will be disconnected as soon as you change the LV7290 settings.

The settings that you specify here will not be initialized even if you initialize the instrument.

Nor are they recorded to presets.



Figure 7-46 LV7290 tab

- Remote Controller

Select whether to send the IP address, subnet mask, and default gateway settings to the LV7290.

Off / On

- IP Address / Subnet Mask / Default Gateway

Set the LV7290's IP address, subnet mask, and default gateway.

7. SYSTEM SETTINGS

- Remote Label

Displays the label of the REMOTE LABEL item placed in the layout.

There is no label in the default settings, but, you can press **F•5** REMOTE LABEL INPUT to enter a label.

Enter up to 16 characters.

You can use the following keys on the label input screen.

F•1	CLEAR ALL	Deletes all characters
F•2	DELETE	Deletes the character at the cursor
F•3	INSERT	Inserts the selected character at the cursor position
F•4	<=	Moves the cursor to the left
F•5	=>	Moves the cursor to the right
F•6	CHAR SET	Enters the character
Function dial (F•D)		Turn to select a character, and press to enter the character.

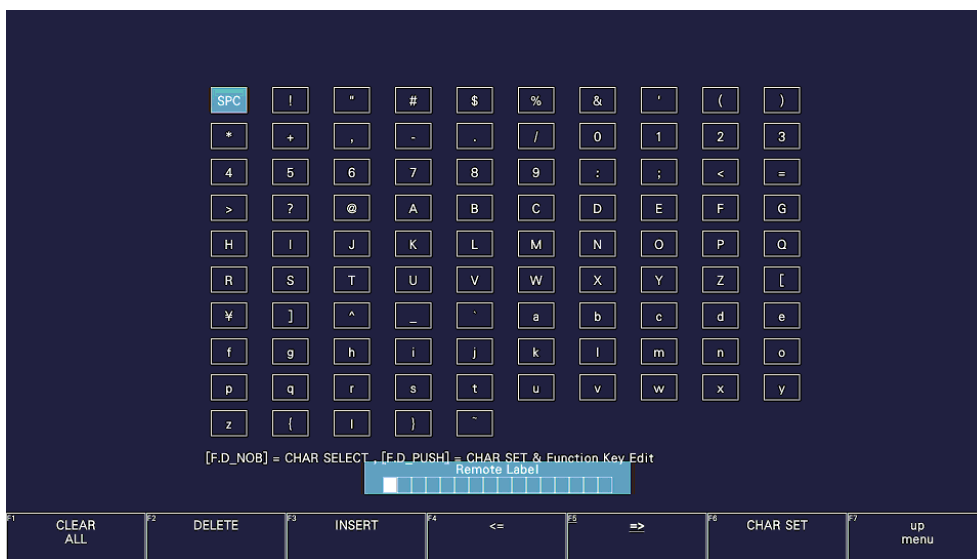

Figure 7-47 Label input screen

- Frame

Turns on and off the frame of the REMOTE LABEL item placed in the layout.

Off / On

- Gray Background

Select whether to display the background of the REMOTE LABEL item placed in the layout in gray.

Off / On

- Connect Destination

Select whether to send the LV5600's and LV7600's IP address to the LV7290.

Off / On

- UNIT-1 to 8 IP Address

Set the connection destination LV5600 and LV7600 IP addresses.

7. SYSTEM SETTINGS

7.3 Displaying System Information

To display the system information, press **F•3** SYSTEM INFO on the SYS menu. You can view the instrument version and the internal temperature on this tab.



Figure 7-48 INFORMATION tab

- **Firmware**
Displays the firmware version.
- **MOTHER / WFM / PICTURE**
Displays the hardware versions.
- **SER01 / SER02 /SER02A / SER03 / SER05 / SER06**
Displays the versions of the installed hardware options.
Units displayed as “NONE” are not installed.
- **Temperature**
The internal temperature is displayed in a bar graph.
The internal temperature is displayed using 6 levels. Green levels indicate normal temperature. If the temperature increases and reaches the yellow area, a “TEMPERATURE” alarm appears at the top of the measurement screen.
If the internal temperature increases still further and reaches the red area, the alarm “OVER HEAT” appears in the upper left area of the measurement screen. When a specific temperature is reached, the power will be shut down.



If either of these alarm appears, immediately turn the power off, and then check for problems with the operating environment. If this alarm appears even though there are no problems with the operating environment, contact your local LEADER agent.

7.4 Installing Software Options

To install options, use **F•4** LICENSE on the SYS menu.

You can use this screen to view the MAC address and install options.

[See also] 2.3, "Software Options"



Figure 7-49 LICENSE tab

- Installing an Option

Have your license key ready, and follow the procedure below.

1. Use the function dial (F•D) to enter the license key number.

Press **F•2** CLEAR to clear the license key to 0000000000.

2. Press **F•3** REGISTER.

"Accepted" appears if the license key has been entered correctly, and the corresponding option becomes usable. The name of the option that has been installed appears in the License List.

"Failed" appears if the license key is not correct. Reenter the license key correctly.

- Disabling an Option

Have your license key ready, and follow the procedure below.

1. Use the function dial (F•D) to enter the license key number.

Press **F•2** CLEAR to clear the license key to 0000000000.

2. Press **F•4** REMOVE.

"Accepted" appears if the license key has been entered correctly, and the corresponding option is disabled. The name of the option is deleted from the License list.

"Failed" appears if the license key is not correct. Reenter the license key correctly.

3. Restart the instrument.

7.5 Adjusting the Backlight (LV5600)

To adjust the backlight, use **F•5** LCD BACK LIGHT on the SYS menu.

The larger the value, the brighter the backlight. Press the function dial (F•D) to return the setting to its default value (28).

1 - 28 - 32

7.6 Turning Off the LCD Panel (LV5600)

To turn off the LCD, press **F•6** LCD OFF on the SYS menu.

To turn it on again, press any key excluding the power switch, double-click, or operate the touch panel.

7.7 Initialization

To initialize the settings and layout, use **F•7** INITIALIZE on the SYS menu.

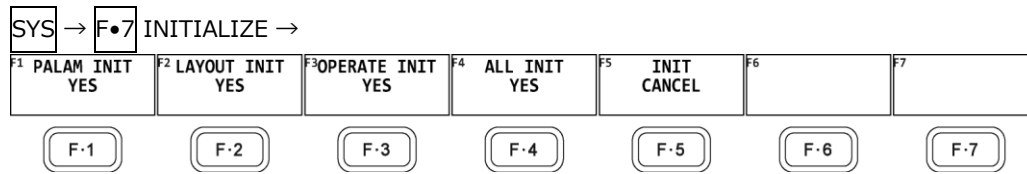

Figure 7-50 INITIALIZE menu

7.7.1 Initializing Settings

To initialize the settings, press **F•1** PARAM INIT YES.

To cancel, press **F•5** INIT CANCEL.

When you initialize the settings, all the settings—excluding those listed below—are initialized. For information about the default values, see chapter 21, “MENU TREES.”

- Network settings (NETWORK tab)
- IP settings (SER05 (IP) tab, SER06 (IP) tab)
- Remote control settings (REMOTE tab)
- RS-422/485 settings (RS485 tab)
- Camera ID settings (excluding Local ID Setting) (CAMERA ID tab)
- Date and time settings (DATE&TIME tab)
- Preset contents
- Measurement screen layout
- Factory Default Settings

If you also want to initialize the above settings (excluding the date and time settings), turn on the power while holding down the V POS and H POS knobs. Release them when about 3 seconds elapse after the power is turned on, and then press **F•3** SRAM/FLASH INIT YES.

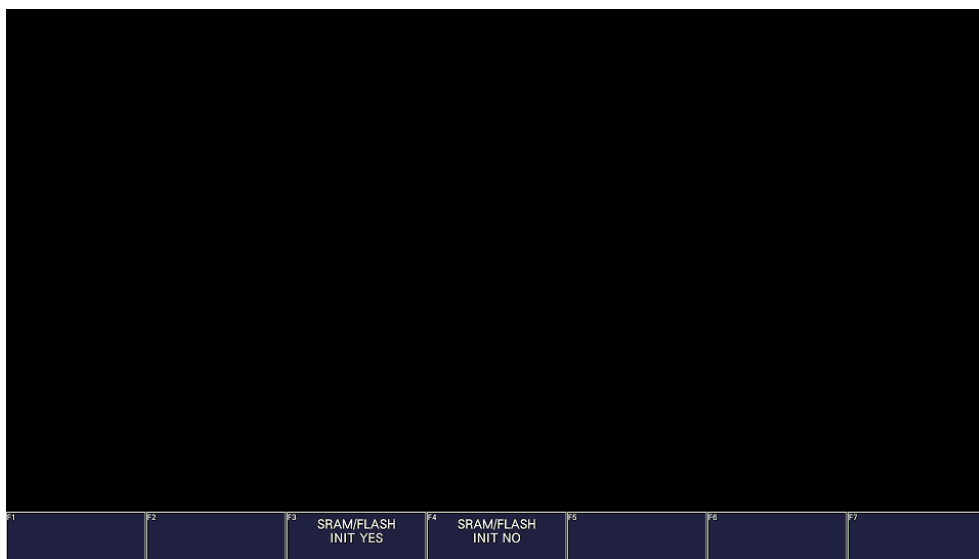

Figure 7-51 Factory default settings

7. SYSTEM SETTINGS

7.7.2 Initializing the Layout

To initialize the layout, press **F•2** LAYOUT INIT YES.

To cancel, press **F•5** INIT CANCEL.

When you initialize the layout, the layouts configured in all measurement displays (11 total) will be initialized. To initialize the layout in each measurement display, click or tap DEFAULT LAYOUT in the appropriate layout window.

[See also] DEFAULT LAYOUT → 6.5.3, "Layout Screen Description"

7.7.3 Initializing the Operation keys

To initialize the operation keys, press **F•3** OPERATE INIT YES.

To cancel, press **F•5** INIT CANCEL.

7.7.4 Initializing the Settings and Layout

To initialize the settings and layout, press **F•4** ALL INIT YES.

To cancel, press **F•5** INIT CANCEL.

8. CAPTURE FEATURE

The capture feature consists of screen capture and frame capture.

- Screen Capture

You can use the screen capture feature to capture still-image data of the screen. You can save the captured data to a USB memory device or overlay it on the input signal on the instrument's display.

In addition, when SER05 or SER06 is installed, the packets captured from IP or Ethernet port can be saved in a USB memory device in PCAP format, and the SDP file set by NMOS can be saved in a USB memory device.

- Frame Capture (SDI Code Value, Converted)

You can use the frame capture feature to capture a single frame or 16 consecutive frames of data from the SDI or IP signal. You can save the captured data to USB memory or overlay it on the input signal on the instrument display.

When data is saved to DPX or TIFF format in Converted mode, the black level is offset to zero.

Because data is captured as frame data, the data can be displayed on the instrument in different display modes. The supported display modes are the video signal waveform, vector, picture, and status (data dump) displays.

In addition, when SER05 or SER06 is installed, the SDP file set by NMOS can be saved in a USB memory device.

- Switching between Screen Capture and Frame Capture (SDI Code Value, Converted)

Use Mode on the CAPTURE & DISPLAY tab to switch between the two.

[See also] CAPTURE & DISPLAY tab → 7.2.4, "Configuring the Capture Feature"

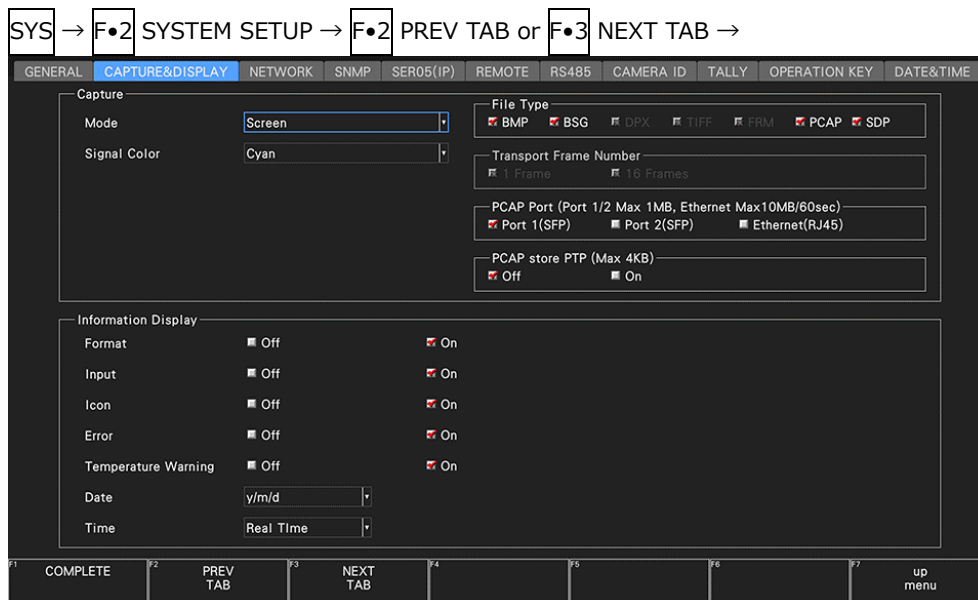

Figure 8-1 CAPTURE & DISPLAY tab

8.1 Screen Capture

8.1.1 Capturing the Displayed Screen

To take a screen capture, follow the procedure below.

1. Display the screen you want to capture.
2. Press CAP.

The screen is captured to the internal memory. You can also take screen captures by pressing **F•2** REFRESH while the CAP menu is displayed.

Note that if you perform one of the following operations after taking a screen capture, the captured data will be deleted.

- Change the measurement screen
- Press INPUT, MULTI, SYS, MEM, or RECALL
- Turn off the power

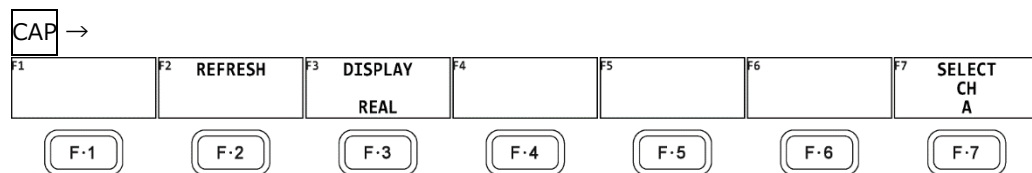

Figure 8-2 CAP menu

8.1.2 Displaying Screen Capture Data

Press CAP to display the acquired screen capture data on the instrument or overlay it on the current input signal.

You can display captured video signal waveform, vector, picture, audio waveform, and eye pattern waveform display data on the instrument. Other kinds of data (such as status and scale data) cannot be displayed. However, these other kinds of data can be saved to a USB memory device as BMP files.

To display screen capture data, press **F•3** DISPLAY on the CAP menu.

<u>REAL</u> :	The current input signal is displayed.
<u>HOLD</u> :	The screen capture data is displayed.
<u>BOTH</u> :	The current input signal and the screen capture data are overlaid with their intensities halved.

8. CAPTURE FEATURE

8.1.3 Saving to a USB Memory Device

Captured data acquired by pressing CAP is deleted when you perform an operation such as changing the measurement screen. However, by saving the screen capture data to a USB memory device in BSG format, you will be able to display the screen capture data on the instrument even after it is restarted.

Also, if you save the screen capture data in BMP format, you can view the captured data on a PC.

Use the CAPTURE & DISPLAY tab on the SYS menu to set the file format.

[See also] CAPTURE & DISPLAY tab → 7.2.4, "Configuring the Capture Feature"

1. Connect a USB memory device to the instrument.

2. Press **F•6** USB MEMORY.

A file list screen and a USB MEMORY menu appear.

3. Select how to name the file.

If **F•1** AUTO FILENAME is set to on, the file is automatically assigned a name that consists of the year, month, day, hour, minute, and second (in that order) that are set on the SYS menu. (Example: 20090501100859.bmp)

Screen capture data is saved to the following locations.

└─ USB memory device

└─ LV5600_USER or LV7600_USER

└─ BMP

└─ yyyyymmddhhmmss.bmp

└─ yyyyymmddhhmmss.bsg

└─ yyyyymmddhhmmss_x.pcap (*1)

When PCAP store PTP is set to off

└─ yyyyymmddhhmmss_ptp_x.pcap (*1)

When PCAP store PTP is set to on

└─ yyyyymmddhhmmss_eth.pcap (*1)

When PCAP Port is set to Ethernet

└─ ip_streamxx.sdp (*2)

*1 Only SER05 or SER06

"x" is the port number.

*2 Only SER05 or SER06

"xx" becomes 01 to 24.

It is the file name when registered by NMOS.

Video

ip_stream01.sdp

ip_stream02.sdp

ip_stream03.sdp

ip_stream04.sdp

Audio

ip_stream05.sdp

ip_stream06.sdp

(Omitted)

ip_stream19.sdp

ip_stream20.sdp

ANC

ip_stream21.sdp

ip_stream22.sdp

ip_stream23.sdp

ip_stream24.sdp

8. CAPTURE FEATURE

If **F•1** AUTO FILENAME is set to off, press **F•2** NAME INPUT to enter the file name. Enter up to 17 characters.

The key operations that you can perform in the file name input display are as follows:

F•1 CLEAR ALL	Deletes all characters
F•2 DELETE	Deletes the character at the cursor
F•4 <=	Moves the cursor to the left
F•5 =>	Moves the cursor to the right
F•6 CHAR SET	Enters the character
Function dial (F•D)	Turn to select a character, and press to enter the character.

After entering the file name, **F•7** up menu. The CAP menu appears.

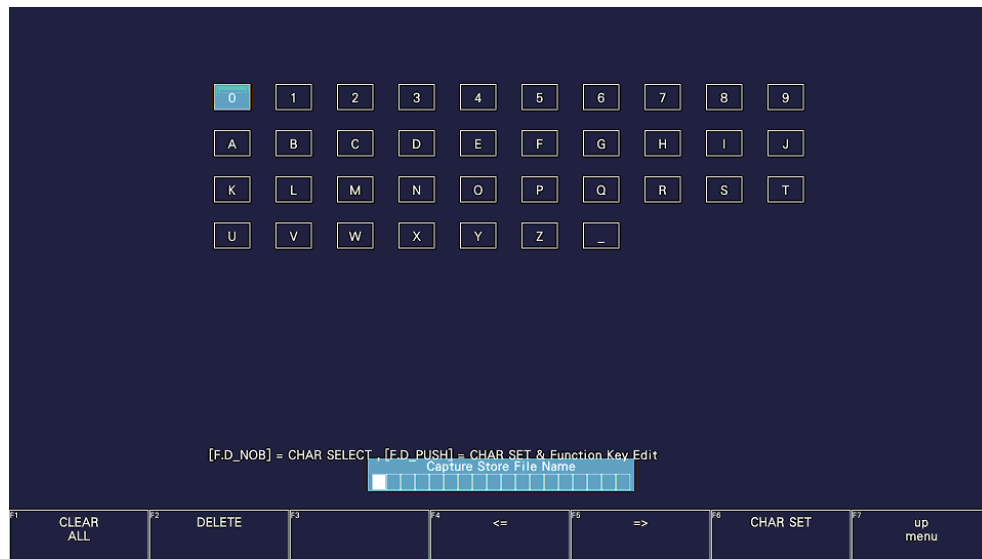

Figure 8-3 File name input screen

4. Press **F•3** STORE.

When AUTO FILENAME is set to on or if the specified file name does not exist in the USB memory device when AUTO FILENAME is set to off, the message "Please wait. Saving file" is displayed on the screen, and the screen capture data is saved to USB memory.

When AUTO FILENAME is set to off and the specified file name exists in the USB memory device, the STORE menu appears.

To overwrite, press **F•1** OVER WRITE DONE. The message "Please wait. Saving file" is displayed on the screen, and the screen capture data is saved to USB memory.

To not overwrite, press **F•3** OVER WRITE CANCEL.

CAP → **F•6** USB MEMORY → **F•3** STORE

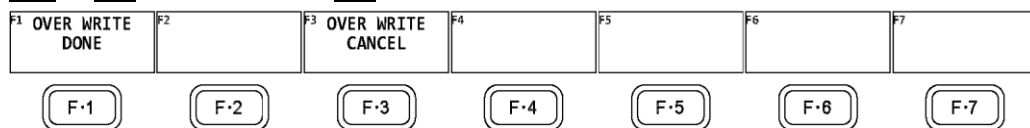

Figure 8-4 STORE menu

8. CAPTURE FEATURE

8.1.4 Displaying Screen Capture Data from a USB Memory Device

To display or overlay on the current input signal the BSG screen capture data that has been saved to a USB memory device, follow the procedure below.

(Screen capture data that has been saved in BMP format and screen capture data that has been saved in BSG format on a different model cannot be displayed on the instrument.)

1. Connect a USB memory device to the instrument.
2. Press CAP.
The CAP menu appears.
3. Press **F•6** USB MEMORY.
A file list screen and a USB MEMORY menu appear.
4. Press **F•5** RECALL.
The BSG format file list screen appears.
5. Turn the function dial (F•D) to select the file that you want to display.
6. Press **F•1** RECALL.
The capture data and CAP menu appear.
7. Press **F•3** DISPLAY to select the display format.
After you press **F•1** RECALL, the display format is BOTH.

8.1.5 Deleting Screen Capture Data from a USB Memory Device

To delete screen capture data from a USB memory device, follow the procedure below. (You can also delete the data on the PC.)

1. Connect a USB memory device to the instrument.
2. Press CAP.
The CAP menu appears.
3. Press **F•6** USB MEMORY.
A file list screen and a USB MEMORY menu appear.
You can also press **F•5** RECALL here to display a BSG format file list screen.
4. Turn the function dial (F•D) to select the file that you want to delete.

8. CAPTURE FEATURE

5. Press **F•5** DELETE FILE.

The DELETE FILE menu appears.

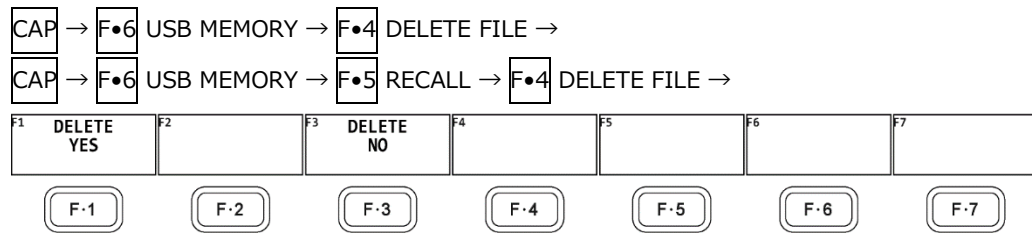

Figure 8-5 DELETE FILE menu

6. Press **F•1** DELETE YES.

To cancel the operation, press **F•3** DELETE NO.

8.2 Frame Capture

8.2.1 Capturing Frame Data

There are two ways to capture frame data. One way is to capture frame data manually, and the other is to capture frame data automatically when errors occur (error capture). When using error capture, use single input mode. It will not work properly in simul mode.

1. Display the screen you want to capture.

The display must be showing video signal waveforms, vectors, or a picture. However, capturing is not possible if an eye pattern (SER02/SER02A) or audio is shown in the same display.

For vector waveforms, press VECT and then set **F•1** VECT INTEN/CONFIG → **F•1** VECTOR DISPLAY to VECTOR. This feature does not support the 5-bar display.

2. Press CAP.

The CAP menu appears.

Unlike screen captures, frame data is not captured when you press CAP.

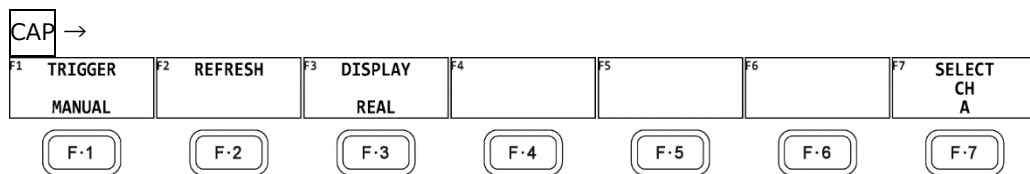

Figure 8-6 CAP menu

- Capturing frame data manually

3. Press **F•1** TRIGGER to select MANUAL.

4. Press **F•2** REFRESH.

Frame data is captured in the instrument.

During single mode, the instrument captures the displayed channel.

During simul mode, the instrument captures all the displayed channels.

- Capturing frame data automatically (error capture)

3. Press **F•1** TRIGGER to select ERROR.

During simul mode, **F•1** TRIGGER does not appear.

4. Press **F•7** SELECT CH to select a channel.

5. Press **F•2** REFRESH.

Error capture for the selected channel begins.

To begin error capture on other channels, repeat steps 4 and 5.

The instrument switches to error standby mode and Channels for which capture is in progress appear in the upper right of the screen. Standby mode is cleared by setting **F•1** TRIGGER to MANUAL.

In Simul mode, "Capture is invalid" will appear, and the capture function will not work.

8. CAPTURE FEATURE

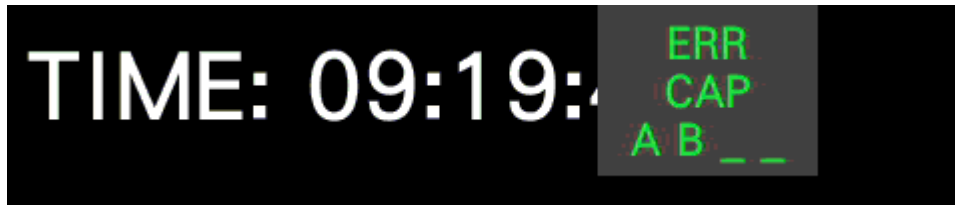

Figure 8-7 Error standby

6. When the message below appears, press any key except for the power key
If an error occurs during error standby, the instrument captures the frame data at that point and stops the frame capture.

The applicable errors are those listed under “Applicable Errors” below whose detection setting has been set to ON through **F•5** STATUS SETUP on the STATUS menu.

Table 8-1 Applicable errors for error capturing

	Applicable Errors	Inapplicable Errors
SDI Error	TRS, Line Number, CRC, EDH, Illegal Code	Frequency, Cable
Ancillary Data Error	Parity, Checksum	-
Embedded Audio Error	BCH, DBN, Parity, Inhibit Line	Sample Count

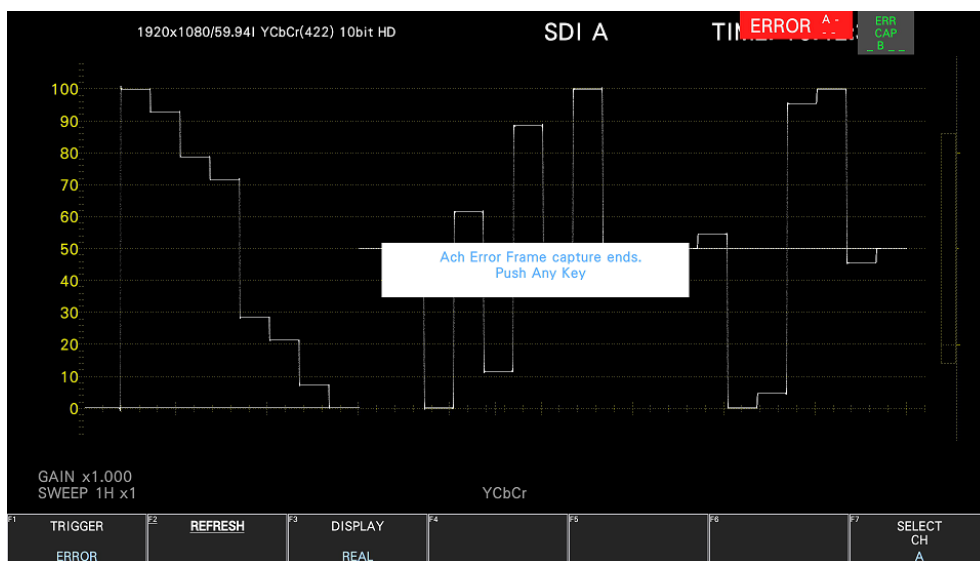

Figure 8-8 Error capture end

8. CAPTURE FEATURE

8.2.2 Displaying Frame Capture Data

You can display the captured frame data on the instrument or overlay it on the current input signal. You can also display the frame data in different display modes.

- Selecting display format

To select the display format, follow the procedure below.

- If the frame data captured to the internal memory does not exist, you cannot select the display format.
- First, show the video signal waveform display, vector display (excluding the 5-bar display), or picture display.
- To display frame data, the instrument must be receiving a signal whose format is the same as that of the captured data.
- The display may blink when you operate the V POS knob, H POS knob, or function dial (F•D).
- The scale and measured values are those of the current signal, not those of the captured data.

Procedure

CAP	→	F•3	DISPLAY: <u>REAL</u> / REPLAY / BOTH / HOLD
-----	---	-----	---

Settings

REAL:	The current input signal is displayed.
REPLAY:	The frame data is displayed. With 3G-B-DL, two video frames are embedded in a single frame data structure, so the screen may flicker. If this happens, set the display format to HOLD. Every time you select HOLD, the image of either frame will be displayed. When Transport Frame Number is set to 16 Frames, 16 consecutive frames (*1) of data are displayed repeatedly.
BOTH:	The current input signal and the frame data are overlaid with their intensities halved. When Transport Frame Number is set to 16 Frames, the data of the first frame of the 16 consecutive frames (*1) is displayed.
HOLD:	The frame data is displayed. For measurements other than 3G-B-DL, we recommend the use of REPLAY. When Transport Frame Number is set to 16 Frames, the data of the first frame of the 16 consecutive frames (*1) is displayed.

*1 The number of frames is 32 for the following formats.

- 3G-B-DL transmission; 3G(QL), 3G(DL)-2K frame rate 60P/59.94P/50P/48P/47.95P
- HD(DL) transmission; frame rate 60P/59.94P/50P/48P/47.95P

8. CAPTURE FEATURE

8.2.3 Saving to a USB Memory Device

The frame data captured in the instrument is cleared when the power is turned off, but you can save the data to a USB memory device. If the file format is set to FRM, you can display the data even after you turn the power off.

Use the CAPTURE & DISPLAY tab on the SYS menu to set the file format.

[See also] CAPTURE & DISPLAY tab → 7.2.4, "Configuring the Capture Feature"

When a frame is captured in simul mode, if Transport Frame Number is set to 1 Frame on the CAPTURE & DISPLAY tab of the SYS menu, the frame data of all captured channels are saved to the USB memory device. If 16 Frames is specified, the frame data of the channel selected with **F•7** SELECT CH is saved to the USB memory device. To save the frame data of another channel to the USB memory device, select the channel with **F•7** SELECT CH.

The procedure to save is the same as with screen captures. After capturing frame data, see the procedure in section 8.1.3, "Saving to a USB Memory Device."

- When Transport Frame Number is set to 1 Frame, frame capture data is saved to the following locations.

- 📁 USB memory device
 - ↳ 📁 LV5600_USER or LV7600_USER
 - ↳ 📁 BMP
 - ↳ 📁 yyyyymmddhhmmss_A to D.dpx
 - ↳ 📁 yyyyymmddhhmmss_A to D.tif
 - ↳ 📁 yyyyymmddhhmmss_A to D.frm

- When Transport Frame Number is set to 16 Frames, frame capture data is saved to the following locations.

- 📁 USB memory device
 - ↳ 📁 LV5600_USER or LV7600_USER
 - ↳ 📁 BMP
 - ↳ 📁 yyyyymmddhhmmss
 - ↳ 📁 yyyyymmddhhmmss_A to D_00 to 15 or 31.frm

8. CAPTURE FEATURE

8.2.4 Displaying Frame Data from a USB Memory Device

To display on this instrument the frame data that has been saved in FRM format to a USB memory device or superimpose the data on the current input signal, follow the procedure below.

Frame data in FRM format that has been saved on a different model cannot be displayed on this instrument.

1. Connect a USB memory device to the instrument.
2. Press CAP.

The CAP menu appears.

3. Press **F•6** USB MEMORY.

The USB MEMORY menu appears.

4. Press **F•5** RECALL.

The FRM format file list screen appears.

5. Turn the function dial (F•D) to select the file that you want to display.

6. Press **F•1** RECALL.

The frame data and CAP menu appear.

To display frame data, the instrument must be receiving a signal whose format is the same as that of the saved data. The FORMAT item at the bottom of the display shows the format of the saved data. It is displayed in green if the format is the same as the current format or in red if the format is not the same. If the FORMAT item is in red, **F•1** RECALL does not appear.

When Transport Frame Number is set to 16 Frames, select the folder in which the 16 frames are stored.

7. Press **F•3** DISPLAY to select the display format.

8.2.5 Deleting Frame Capture Data from a USB Memory Device

The procedure to delete is the same as with screen captures. See 8.1.5, "Deleting Screen Capture Data from a USB Memory Device."

Note that when you press **F•5** RECALL, however, the FRM format file list will appear.

9. PRESET FEATURE

The preset feature stores up to 60 sets of panel settings. It can be used to easily recall fixed settings.

Also, you can use the same settings on multiple instruments by copying presets to USB memory.

All items except the items below are stored in a preset. Stored items are not deleted even if you initialize the settings.

- Network settings (NETWORK tab)
- IP settings (SER05 (IP) tab, SER06 (IP) tab)
- Remote control settings (REMOTE tab)
- RS-422/485 settings (RS485 tab)
- Camera ID settings (excluding Local ID Setting) (CAMERA ID tab)
- Date and time settings (DATE&TIME tab)

9.1 Registering Presets

To register a selected preset, follow the procedure below.

1. Display the screen you want to register.

You can prevent overwriting presets by setting Preset Overwrite to Disable on the GENERAL tab of the SYS menu. To overwrite presets, set Preset Overwrite to Enable. Note that even when set to Disable, registering to an empty preset is possible.

You can set the menu that appears when a preset is recalled on the GENERAL tab of the SYS menu in advance.

[See also] GENERAL tab → 7.2.1, "General Settings"

2. Press MEM.

The preset registration screen appears.

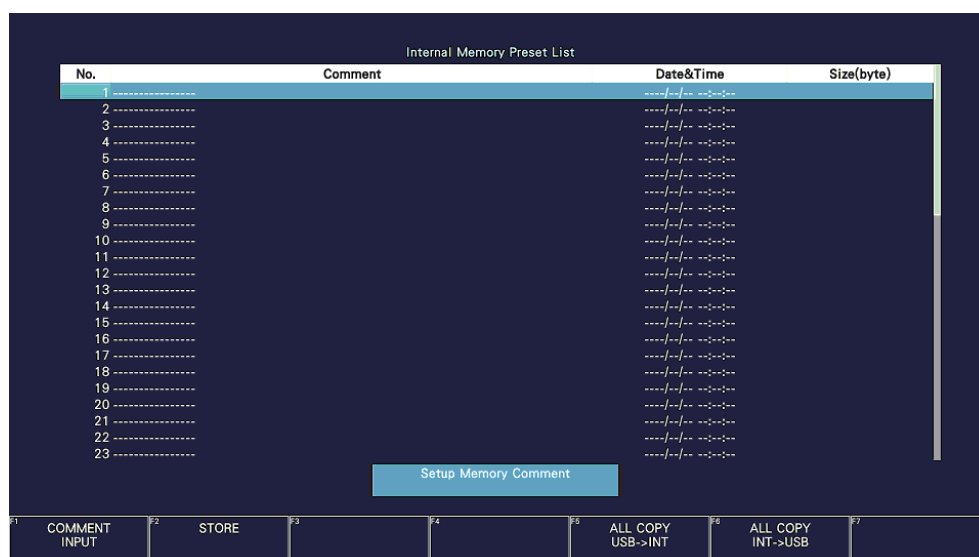

Figure 9-1 Preset registration screen

9. PRESET FEATURE

- Press **F•1** COMMENT INPUT.

The comment input screen appears.

You can also copy a comment from a preset that already has a comment saved to it. To copy a comment, on the preset registration display, move the cursor to the preset that has the comment that you want to copy, and press the function dial (F•D).

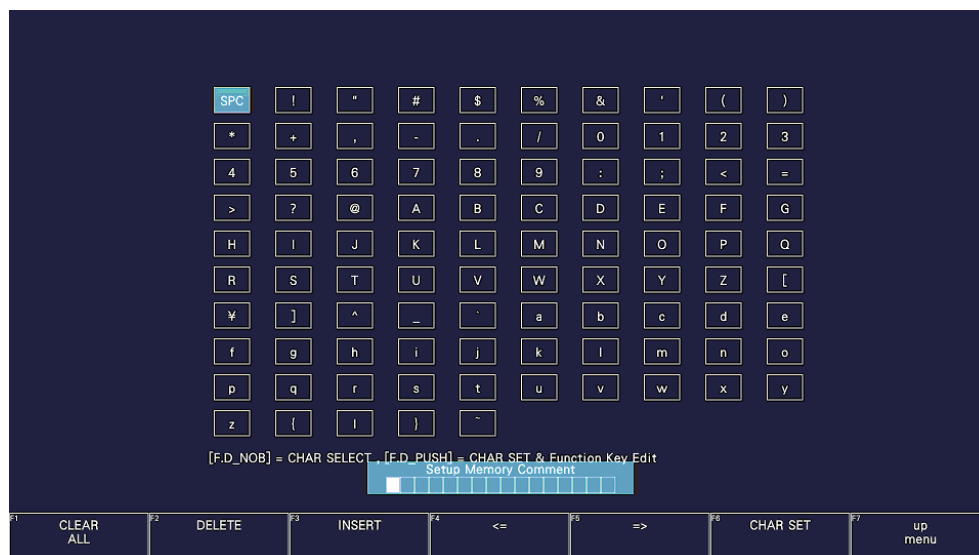

Figure 9-2 Comment input screen

- Enter a comment of up to 16 characters.

You can use the following keys on the comment input screen.

F•1 CLEAR ALL	Deletes all characters
F•2 DELETE	Deletes the character at the cursor
F•3 INSERT	Inserts the selected character at the cursor position
F•4 <=	Moves the cursor to the left
F•5 =>	Moves the cursor to the right
F•6 CHAR SET	Enters the character
Function dial (F•D)	Turn to select a character, and press to enter the character.

- Press **F•7** up menu.
- Turn the function dial (F•D) to select the number of the preset you want to register.
- Press **F•2** STORE.

If a preset has already been stored with the number that you selected, the STORE menu appears. To overwrite the existing preset, press **F•1** OVER WRITE YES. Otherwise, press **F•4** OVER WRITE NO.

F•2 STORE does not appear if Preset Overwrite is set to Disable on the GENERAL tab of the SYS menu.

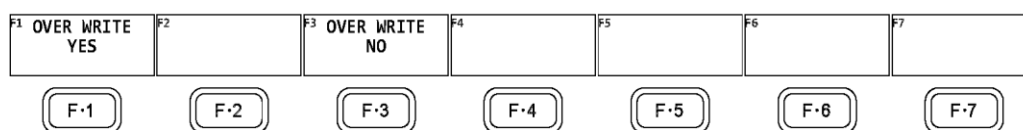

Figure 9-3 STORE menu

9.2 Loading Presets

To recall a preset, follow the procedure below.

1. Press RECALL.

The RECALL menu appears.

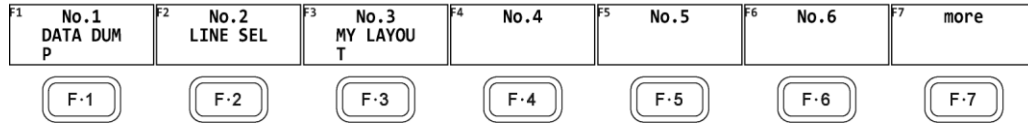

Figure 9-4 RECALL menu

2. Press a key from **F.1** No.1 to **F.6** No.6.

If the preset that you want to load is number 7 or greater, press **F.7** more or turn the function dial (F•D).

The menu that appears immediately after loading the preset is either the RECALL menu or measurement menu depending on the setting that was specified on the GENERAL tab when the preset was registered.

[See also] GENERAL tab → 7.2.1, “General Settings”

9. PRESET FEATURE

9.3 Deleting Presets

To delete a preset, follow the procedure below.

1. Press MEM.

The preset registration screen appears.

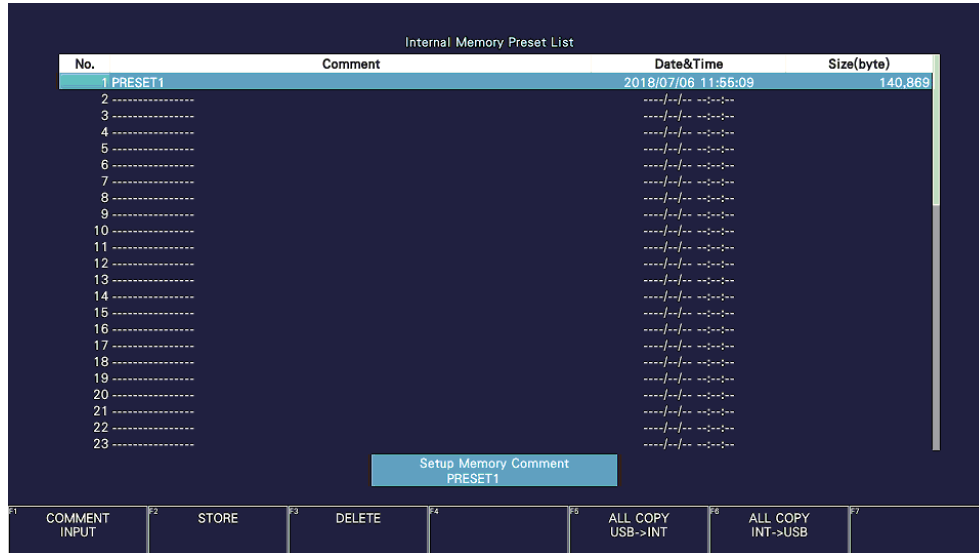

Figure 9-5 Preset registration screen

2. Turn the function dial (F•D) to select the file that you want to delete.

3. Press **F•3** DELETE.

The DELETE menu appears.

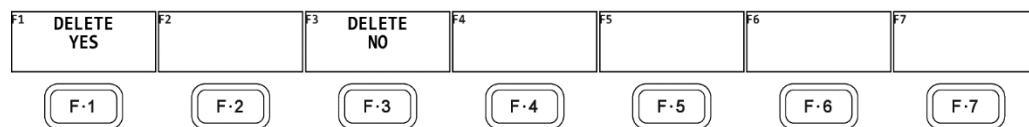

Figure 9-6 DELETE menu

4. Press **F•1** DELETE YES.

To cancel the operation, press **F•3** DELETE NO.

9. PRESET FEATURE

9.4 Copying All Presets from the instrument to a USB Memory Device

To copy all the presets from the instrument to a USB memory device, follow the procedure below.

1. Connect a USB memory device to the instrument.
2. Press MEM.

The preset registration screen appears.

No.	Comment	Date&Time	Size(byte)
1	PRESET1	2018/07/06 11:56:09	140,869
2
3
4
5
6
7
8
9
10
11
12
13
14
15
16
17
18
19
20
21
22
23

Setup Memory Comment
PRESET1

F1 COMMENT INPUT F2 STORE F3 DELETE F4 F5 ALL COPY USB->INT F6 ALL COPY INT->USB F7

Figure 9-7 Preset registration screen

3. Press **F•6** ALL COPY INT->USB.

The ALL COPY INT->USB menu appears.

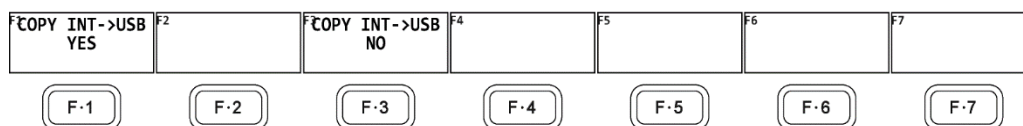

Figure 9-8 ALL COPY INT->USB menu

4. Press **F•1** COPY INT->USB YES.

To cancel the copy operation, press **F•3** COPY INT->USB NO. If the USB memory device already contains presets, they will be overwritten.

Presets are saved to the following location.

Note that if you use a PC to change the names of the files stored in the USB memory device, you will no longer be able to copy the altered presets from the USB memory device to an instrument.

The preset data copied here can be used mutually on LV5600 and LV7600.

📁 USB memory device

└─ 📁 LV5600_USER or LV7600_USER

└─ 📁 PSET

└─ 📁 PSET01_*.PRE (- PSET60_*.PRE) *: comment

9. PRESET FEATURE

9.5 Copying All Presets from a USB Memory Device to the instrument

To copy all the presets from a USB memory device to the instrument, follow the procedure below.

1. Connect a USB memory device to the instrument.
2. Press MEM.

The preset registration screen appears.

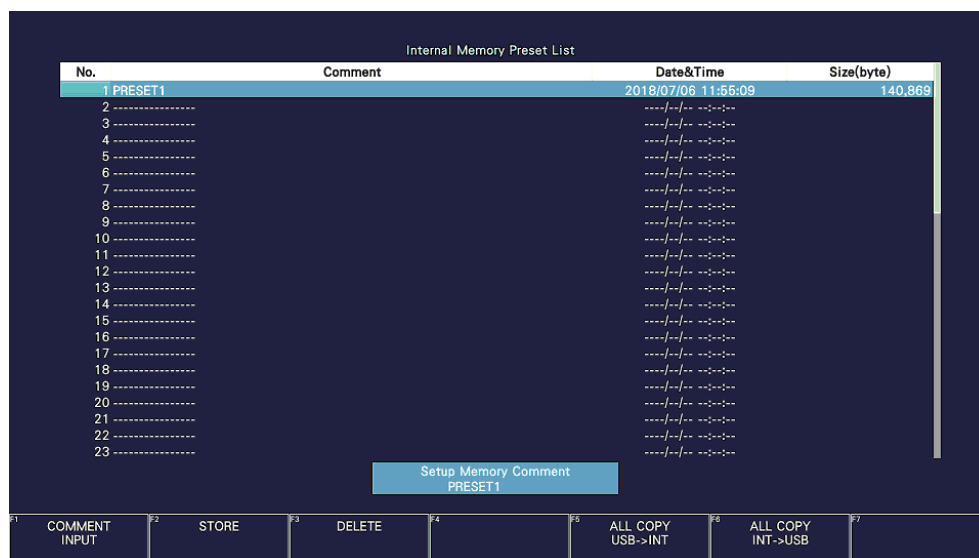

Figure 9-9 Preset registration screen

3. Press **F•5** ALL COPY USB->INT.

The ALL COPY USB->INT menu appears.

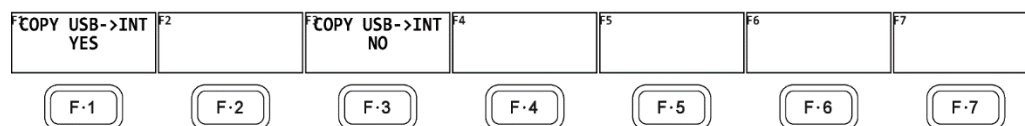

Figure 9-10 ALL COPY USB->INT menu

4. Press **F•1** COPY USB->INT YES.

To cancel the copy operation, press **F•3** COPY USB->INT NO. If the instrument already has presets, the operation will be according to the Preset Overwrite setting on the GENERAL tab.

10. VIDEO SIGNAL WAVEFORM DISPLAY

To display the video signal waveform, press WFM.

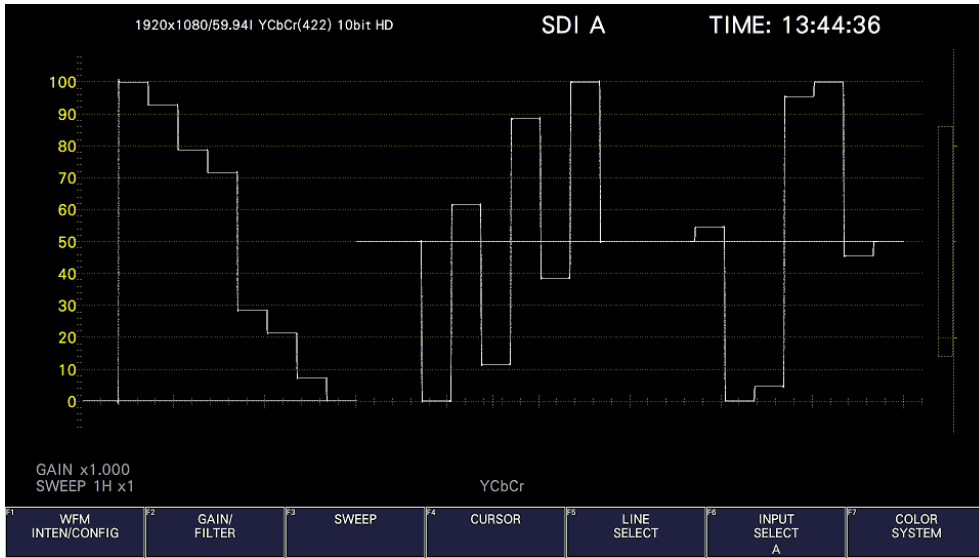

Figure 10-1 Video signal waveform display

- Colorimetry

Normally, colorimetry is not displayed, but when the colorimetry alarm on the SYS menu is set to on and a colorimetry different from the one specified is received, the alarm is indicated in red in the upper left of the screen.

10.1 Operation Key Description

On the LV5600, operation keys other than S-CUT can be controlled from the mouse and touch panel. On the LV7600, keys can be controlled from the panel, mouse, and touch panel. On the video signal waveform display, you can press the operation keys to change the following settings. (Some settings may not be changed.) The key LEDs light when the underlined setting is selected.

Key assignments can be changed freely on the OPERATION KEY tab.

[See also] OPERATION KEY tab → 7.2.15, "Setting the Operation keys"

Table 10-1 Operation Key Actions

	Setting	Notes
FORM	Y / <u>YCbCr</u> / YGBR / GBR / YRGB / RGB / COMPOSITE	
OVLAY	OVERLAY / PARADE	
FILTER	FLAT / LOWPASS	During component display
	FLAT / LUM / FLAT+LUM / LUM+CRMA	During pseudo-composite display
GAIN	CAL / VARIABLE	
MAG (GAIN)	X1 / X5 0% / X5 +90%	X5 + 10% to X5 + 80%
SWEEP	1H / 2H / 1V / 2V	
MAG (SWEEP)	X1 / X10 / X20 / X40	ACTIVE and BLANK are also selectable.

10.2 Setting the Waveform Display Position

Use the V POS and H POS knobs to adjust the display position of video signal waveforms. On the multi display, these are valid when you press **F•2** MULTI WFM on the MULTI menu.

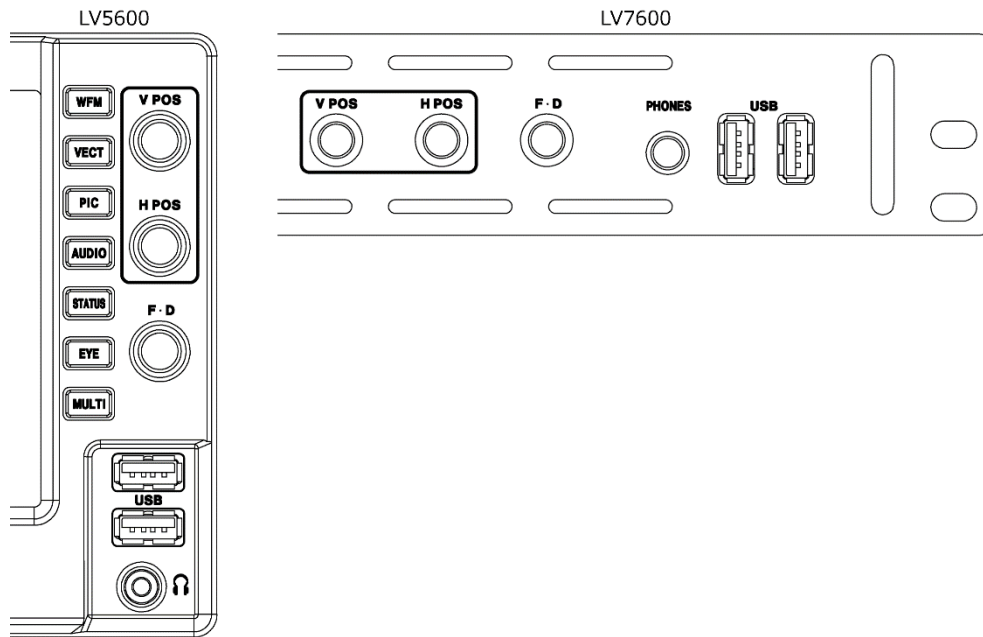

Figure 10-2 V POS and H POS knobs

- V POS Knob
This knob adjusts the vertical position of the video signal waveform. Pressing the knob returns the waveform to its default position.
- H POS Knob
This knob adjusts the horizontal position of the video signal waveform. Pressing the knob returns the waveform to its default position.

10.3 Configuring the Display Settings

To configure the display settings, press **F•1** WFM INTEN/CONFIG on the WFM menu.

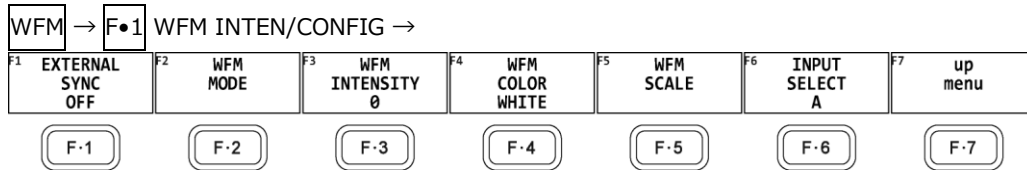

Figure 10-3 WFM INTEN/CONFIG menu

10.3.1 Selecting the Display Mode

To configure the display mode settings, press **F•2** WFM MODE on the WFM INTEN/CONFIG menu.

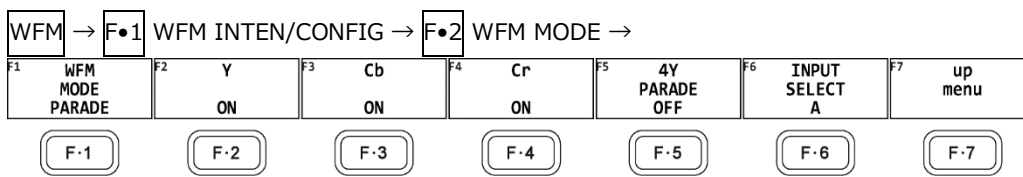

Figure 10-4 WFM MODE menu

To select the video signal waveform display mode, follow the procedure below.

This setting is invalid when COLOR MATRIX is set to COMPOSITE.

[See also] COLOR MATRIX → section 10.8.1, "Selecting the Color Matrix."

Procedure



Settings

- OVERLAY: The input signals are displayed overlaid.
- PARADE: The input signals are displayed side by side.

WFM MODE = OVERLAY

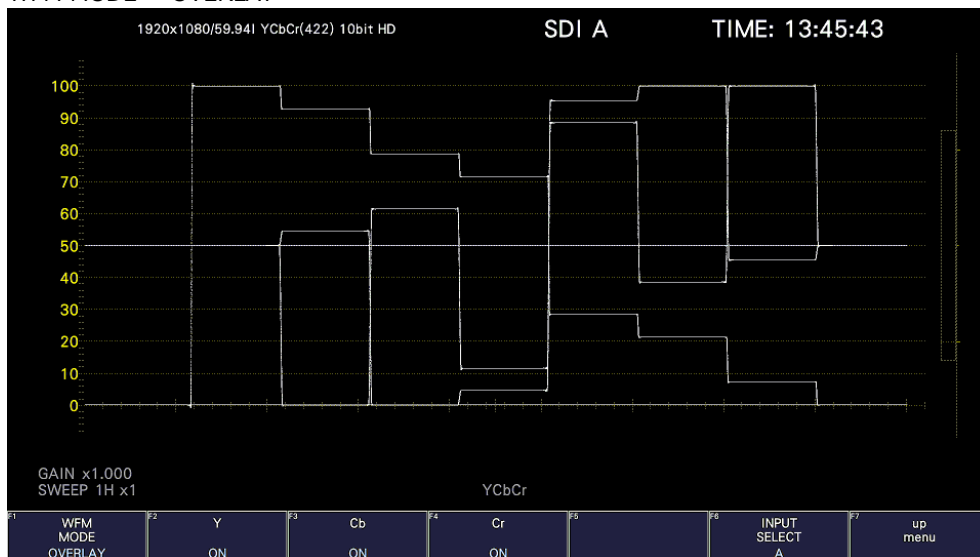

10. VIDEO SIGNAL WAVEFORM DISPLAY

WFM MODE = PARADE

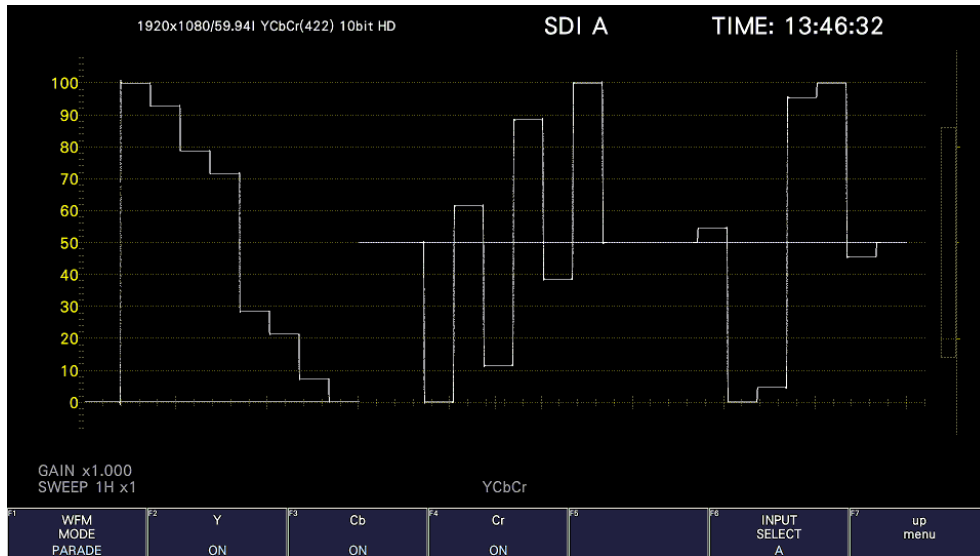

Figure 10-5 Selecting the display mode

10.3.2 Turning the Channels On and Off

To turn the waveforms on and off, follow the procedure below.

You cannot turn all the waveforms off.

This menu item is not displayed when COLOR MATRIX is set to COMPOSITE or when YGBR or YRGB is set to ON.

[See also] COLOR MATRIX → section 10.8.1, "Selecting the Color Matrix."

YGBR, YRGB → section 10.8.2, "Turning Luminance Signals On and Off."

Procedure

WFM	→	F•1	WFM INTEN/CONFIG	→	F•2	WFM MODE
→	F•2	Y / G / R / X:	ON / OFF			
→	F•3	Cb / B / G / Y:	ON / OFF			
→	F•4	Cr / R / B / Z:	ON / OFF			

10. VIDEO SIGNAL WAVEFORM DISPLAY

10.3.3 4Y Parade Display

To extract the Y signals from channels 1 to 4 and display them side by side, follow the procedure below.

The conditions for displaying the 4Y parade display are listed below.

- SDI System is set to 2K SD/HD/3G-A/3G-B-DL.
- Simul mode
- **F•6** OPERATE CH MODE on the INPUT menu is set to COM.
- **F•7** COLOR SYSTEM → **F•1** COLOR MATRIX on the WFM menu is set to YCbCr or COMPOSITE.
- The layout display mode is set to NORMAL.

Also, note the following points.

- Only the channels that have been set to ON on the INPUT menu are displayed.
- Option in layout will be hidden.
- Style in layout will be invalid.
- The scale jump function cannot be used.

Procedure

WFM	→	F•1	WFM INTEN/CONFIG	→	F•2	WFM MODE	→	F•5	4Y PARADE: ON / <u>OFF</u>
-----	---	------------	------------------	---	------------	----------	---	------------	----------------------------

10.3.4 Configuring the 3G-B DS Display

When measuring 3G-B DS, to select the display mode, follow the procedure below.

Procedure

WFM	→	F•1	WFM INTEN/CONFIG	→	F•2	WFM MODE	→	F•5	3G-B-DS DISPLAY: STREAM1 / STREAM2 / MIX / <u>ALIGN</u>
-----	---	------------	------------------	---	------------	----------	---	------------	--

Settings

STREAM1:	Stream 1 is displayed.
STREAM2:	Stream 2 is displayed.
MIX:	Streams 1 and 2 are displayed on top of each other.
ALIGN:	Streams 1 and 2 are displayed side by side.

10.3.5 Adjusting the Waveform Intensity

To adjust the video signal waveform intensity, follow the procedure below.

Press the function dial (F•D) to return the setting to its default value (0).

Procedure

WFM	→	F•1	WFM INTEN/CONFIG	→	F•3	WFM INTENSITY: -128 - <u>0</u> - 127
-----	---	------------	------------------	---	------------	--------------------------------------

10. VIDEO SIGNAL WAVEFORM DISPLAY

10.3.6 Selecting the Waveform Color

To select the video signal waveform color, follow the procedure below.

On the multi display, the following colors are assigned to the video signal waveforms.

Y: White Cb: Cyan Cr: Magenta

G: Green B: Blue R: Red

X: White Y: Cyan Z: Magenta

COMPOSITE: White

Procedure (a signal other than 2K 3G-B DS)

WFM → F•1 WFM INTEN/CONFIG → F•4 WFM COLOR: WHITE / YELLOW / CYAN / GREEN / MAGENTA / RED / BLUE / MULTI

Procedure (2K 3G-B DS)

WFM → F•1 WFM INTEN/CONFIG → F•4 WFM COLOR
 → F•1 STREAM1 COLOR: WHITE / YELLOW / CYAN / GREEN / MAGENTA / RED / BLUE / MULTI
 → F•2 STREAM2 COLOR: WHITE / YELLOW / CYAN / GREEN / MAGENTA / RED / BLUE / MULTI

10.3.7 Adjusting the Scale Intensity

To configure the scale, press F•5 WFM SCALE on the WFM INTEN/CONFIG menu.

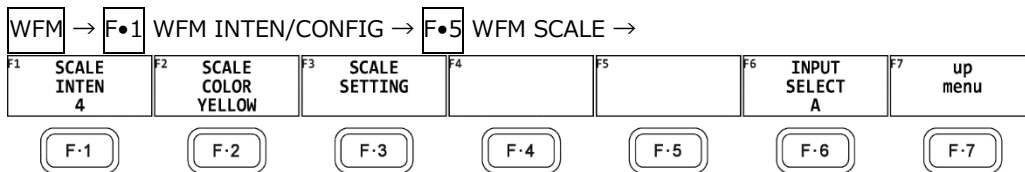

Figure 10-6 WFM SCALE menu

To adjust the scale intensity, follow the procedure below.

Press the function dial (F•D) to return the setting to its default value (4).

Procedure

WFM → F•1 WFM INTEN/CONFIG → F•5 WFM SCALE → F•1 SCALE INTEN: -8 - 4 - 7

10.3.8 Selecting the Scale Color

To select the scale color, follow the procedure below.

Procedure

WFM → F•1 WFM INTEN/CONFIG → F•5 WFM SCALE → F•2 SCALE COLOR: WHITE / YELLOW / CYAN / GREEN / MAGENTA / RED / BLUE

10. VIDEO SIGNAL WAVEFORM DISPLAY

10.3.9 Selecting the Scale Unit

To select the scale unit, follow the procedure below.

When COLOR MATRIX is set to COMPOSITE and the composite display format is NTSC, the scale unit setting is fixed at %. When the composite display format is PAL, this is fixed to V.

Video signal white (100 %) becomes 0.7 V or 100 % on the scale.

Video signal black (0 %) becomes 0 V or 0 % on the scale.

[See also] COLOR MATRIX → section 10.8.1, "Selecting the Color Matrix."

Procedure

WFM → F•1 WFM INTEN/CONFIG → F•5 WFM SCALE → F•3 SCALE SETTING → F•1 SCALE UNIT: HDV,SD% / HDV,SDV / HD%,SD% / CV DEC / CV HEX / V / %

Settings

HDV,SD%:	The scale shows voltages when the input signal is not SD and percentages when the input signal is SD.
HDV,SDV:	The scale shows voltages.
HD%,SD%:	The scale shows percentages.
CV DEC:	0 to 100 % is displayed as 64 to 940 (YGBR) or 64 to 960 (CbCr). For XYZ, 0 to 100% is displayed as 0 to 4095.
CV HEX:	0 to 100 % is displayed as 040 to 3AC (YGBR) or 040 to 3C0 (CbCr). For XYZ, 0 to 100% is displayed as 000 to FFF.
V	The scale shows voltages.
%	The scale shows percentages.

SCALE UNIT = HDV,SDV

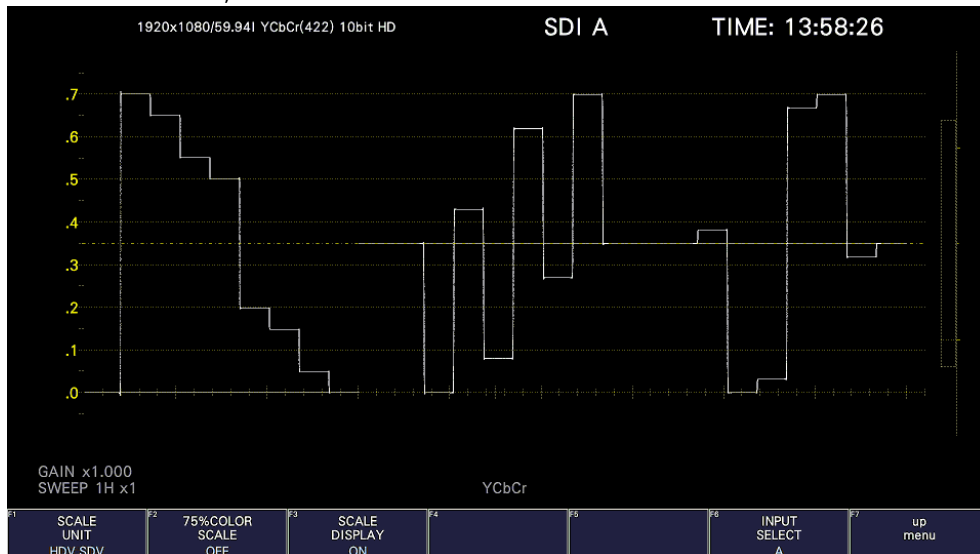

10. VIDEO SIGNAL WAVEFORM DISPLAY

SCALE UNIT = HD%,SD%

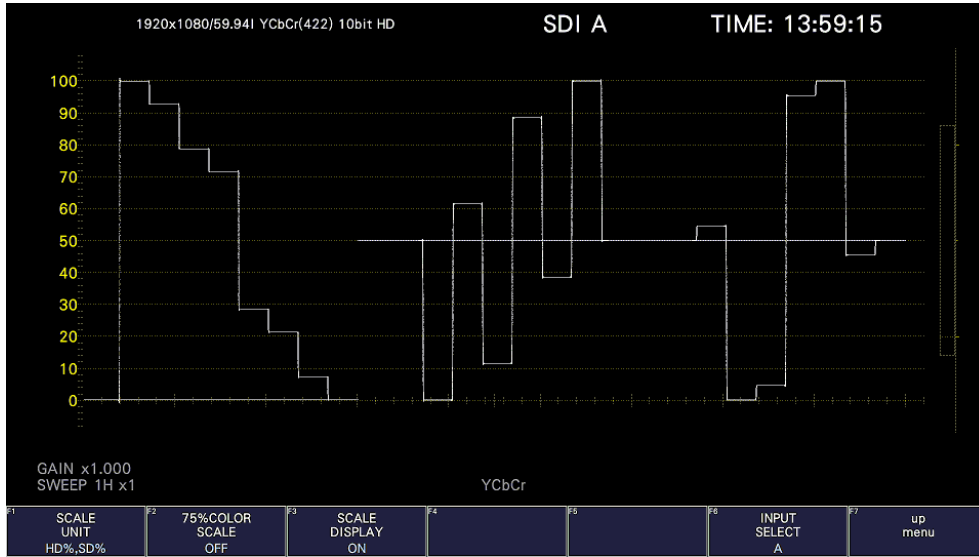

SCALE UNIT = CV DEC

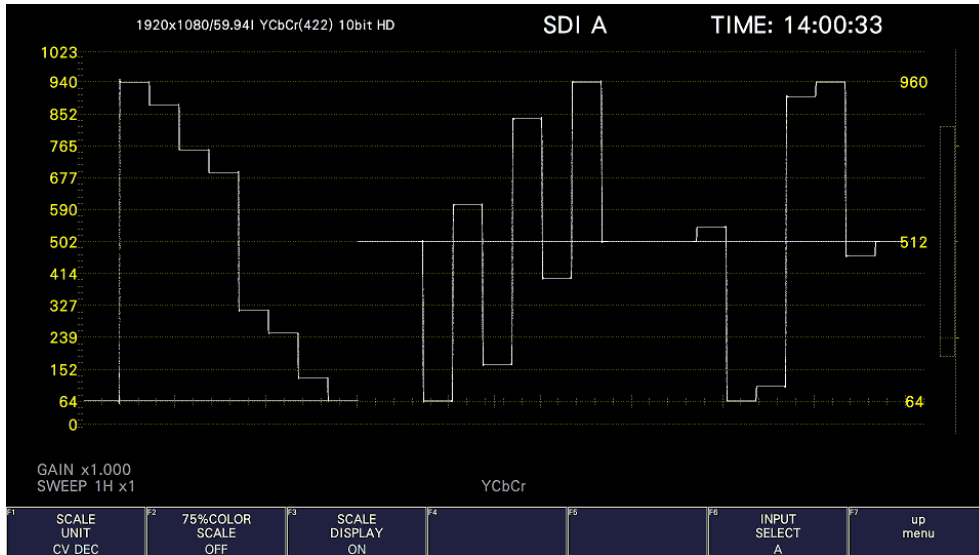

SCALE UNIT = CV HEX

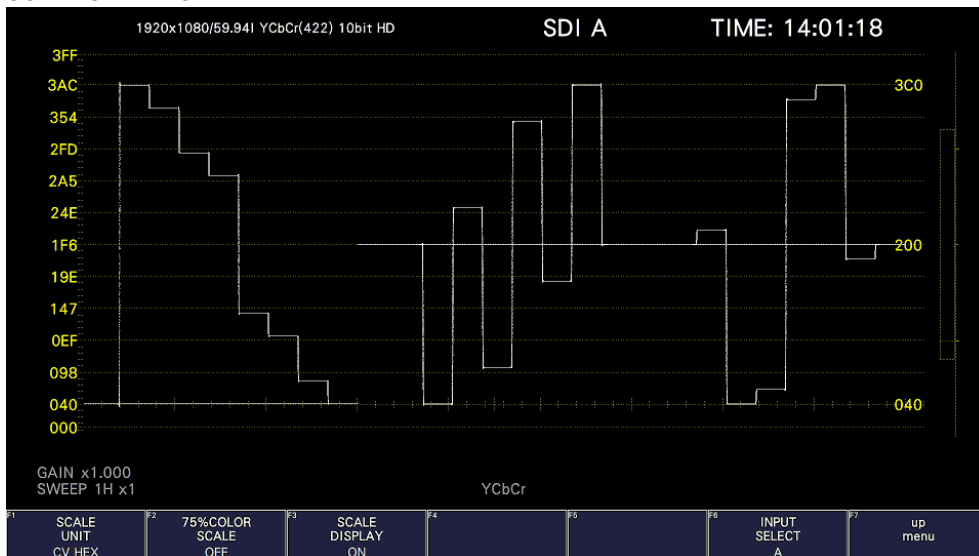

Figure 10-7 Selecting the scale unit

10. VIDEO SIGNAL WAVEFORM DISPLAY

10.3.10 Displaying a Scale for 75% Color Bars

When COLOR MATRIX is set to YCbCr, to display a scale on which a 75% color bar signal input is mapped to the peak level of the chrominance, follow the procedure below.

[See also] COLOR MATRIX → section 10.8.1, "Selecting the Color Matrix."

Procedure

WFM → F•1 WFM INTEN/CONFIG → F•5 WFM SCALE → F•3 SCALE SETTING → F•2 75%
COLOR SCALE: ON / OFF

75%COLOR SCALE = ON

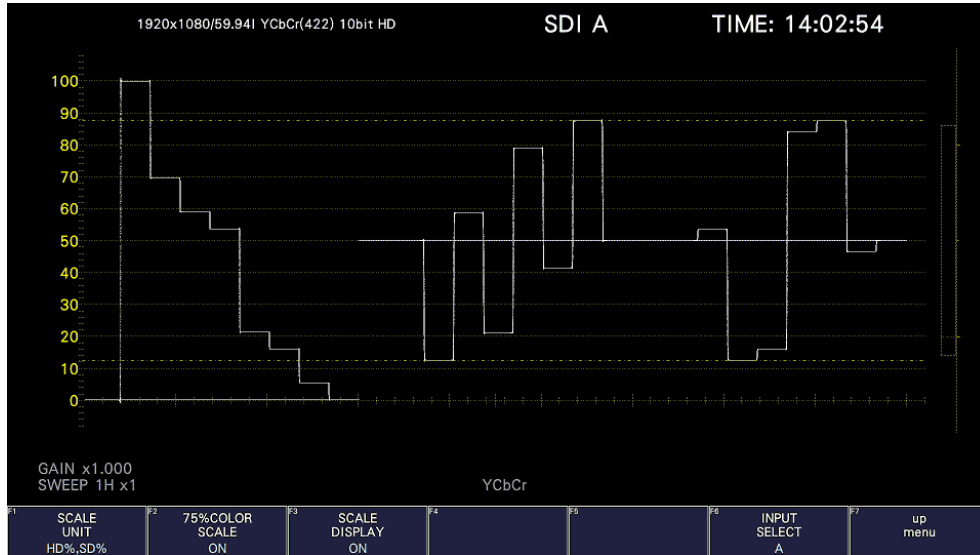

Figure 10-8 Displaying a scale for 75 % color bars

10. VIDEO SIGNAL WAVEFORM DISPLAY

10.3.11 Displaying the Scale

To turn the scale display on and off, follow the procedure shown below.

Procedure

WFM → F•1 WFM INTEN/CONFIG → F•5 WFM SCALE → F•3 SCALE SETTING → F•3 SCALE DISPLAY: ON / OFF

SCALE DISPLAY = OFF

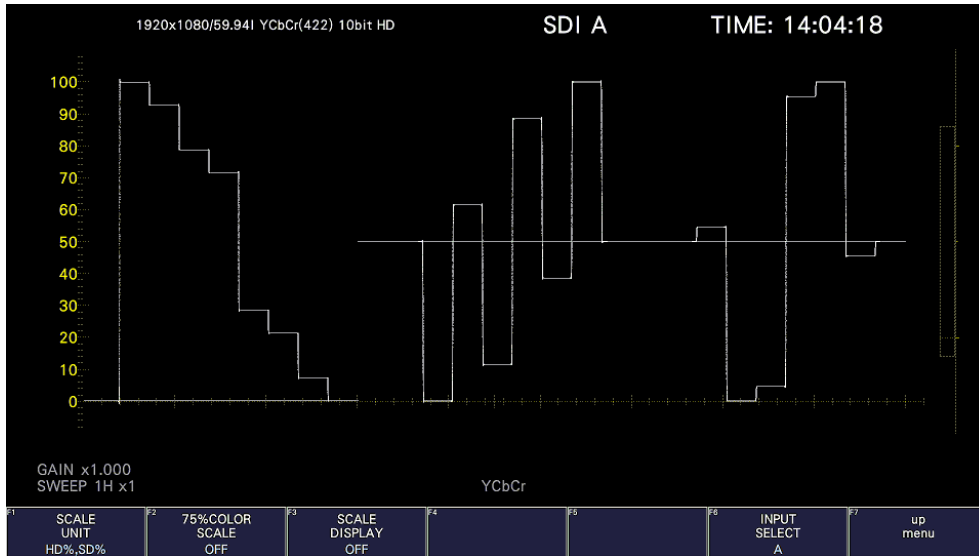

Figure 10-9 Displaying the scale

10.4 Configuring the Gain and Filter Settings

To configure the gain and filter settings, press **F•2** GAIN/FILTER on the WFM menu.

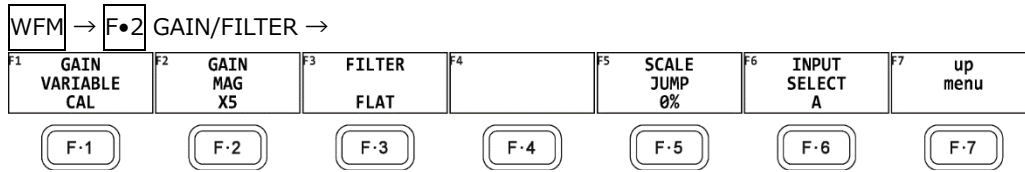

Figure 10-10 GAIN/FILTER menu

You cannot set these when external sync signal waveform display is in use. They are set to the following values.

- GAIN VARIABLE: CAL
- GAIN MAG: X1
- FILTER: FLAT

10.4.1 Setting the Variable Gain

To set the variable video signal waveform gain, follow the procedure below.

Procedure

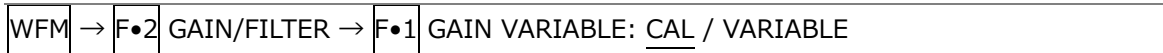

Settings

CAL:	The waveform gain is fixed.
VARIABLE:	You can adjust the waveform gain by turning the function dial (F•D). Press the function dial (F•D) to return the setting to its default value (1.000 or 5.000). The adjusted gain value (the combination of F•1 GAIN VARIABLE and F•2 GAIN MAG) appears at the bottom of the screen. 0.200 - <u>1.000</u> - 2.000 (for X1) 1.000 - <u>5.000</u> - 10.000 (for X5) 2.000 - <u>10.000</u> (for X10)

10.4.2 Selecting the Fixed Gain

To select the fixed video signal waveform gain, follow the procedure below.

Procedure

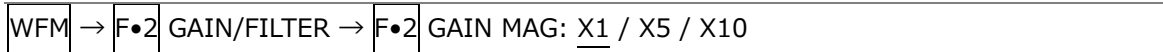

10. VIDEO SIGNAL WAVEFORM DISPLAY

10.4.3 Selecting the Filter

To select the filter to apply to video signal waveforms, follow the procedure below. The filters that you can select vary depending on the COLOR MATRIX setting.

[See also] COLOR MATRIX → section 10.8.1, "Selecting the Color Matrix."

Procedure (When COLOR MATRIX is set to YCbCr, GBR, or RGB)

WFM → F•2 GAIN/FILTER → F•3 FILTER: FLAT / LOWPASS

Settings

FLAT: A filter with a flat frequency response over the entire bandwidth of the input signal is applied.

LOWPASS: A low-pass filter with the following characteristics is applied.
At 40 MHz, 20 dB attenuation or more (when the input signal is 1080/60P, 59.94P, or 50P)
At 20 MHz, 20 dB attenuation or more (when the input signal is 3G, HD, or HD (DL) excluding 1080/60P, 59.94P, or 50P)
At 3.8 MHz, 20 dB attenuation or more (when the input signal is SD)

FILTER = FLAT

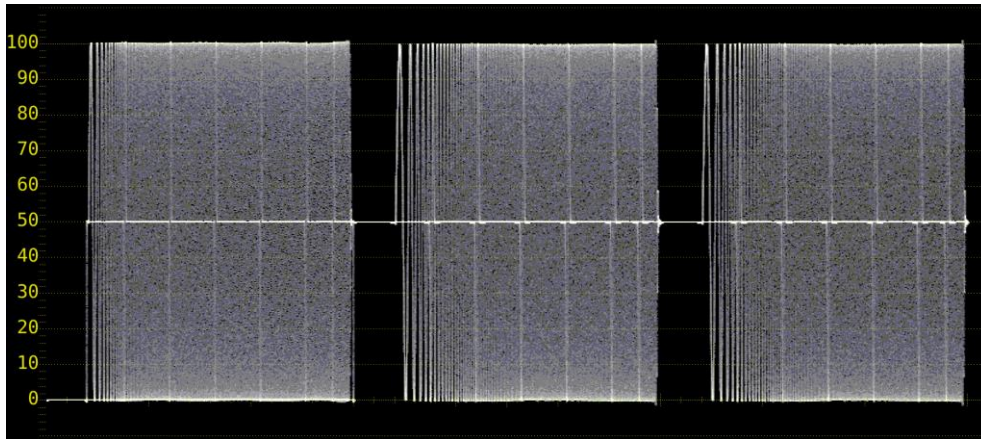

FILTER = LOWPASS

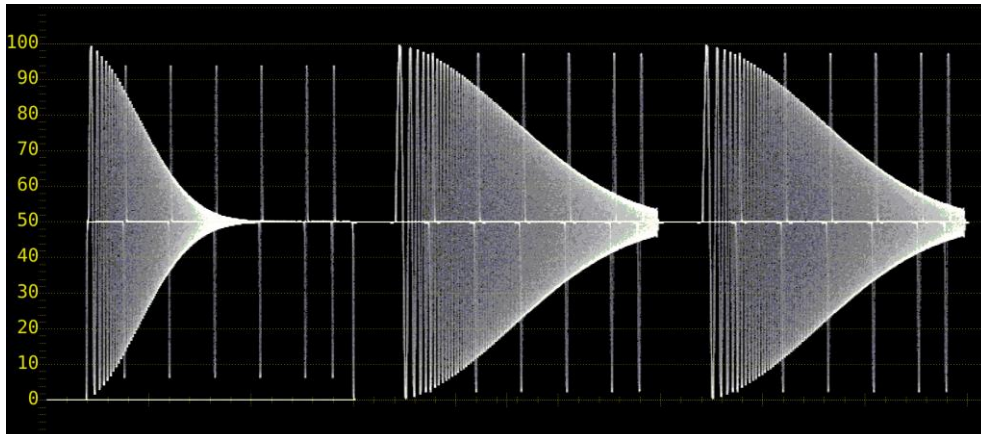

Figure 10-11 Selecting the filter (component)

10. VIDEO SIGNAL WAVEFORM DISPLAY

Procedure (When COLOR MATRIX is set to COMPOSITE)

WFM	→	F•2	GAIN/FILTER	→	F•3	FILTER: <u>FLAT</u> / LUM / FLAT+LUM / LUM+CRMA
-----	---	-----	-------------	---	-----	---

Settings

- | | |
|-----------|--|
| FLAT: | Only the pseudo-composite signal is displayed. |
| LUM: | Only the luminance signal is displayed. |
| FLAT+LUM: | The pseudo-composite and luminance signals are displayed side by side. A filter with an attenuation of 20 dB or more at 40 MHz is applied to the luminance signal. |
| LUM+CRMA: | The luminance and chrominance signals are displayed side by side. A filter with an attenuation of 20 dB or more at 40 MHz is applied to the luminance signal. |

FILTER = FLAT

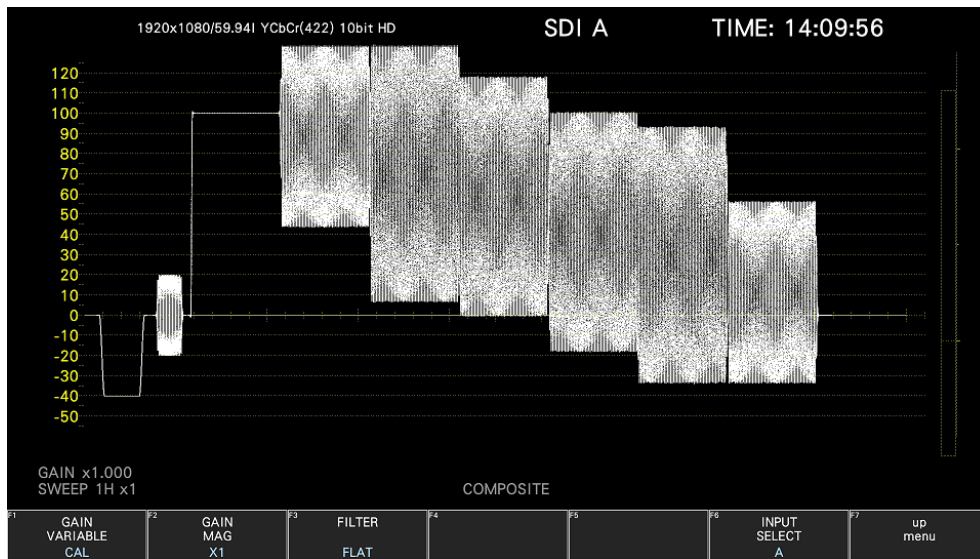

10. VIDEO SIGNAL WAVEFORM DISPLAY

FILTER = LUM

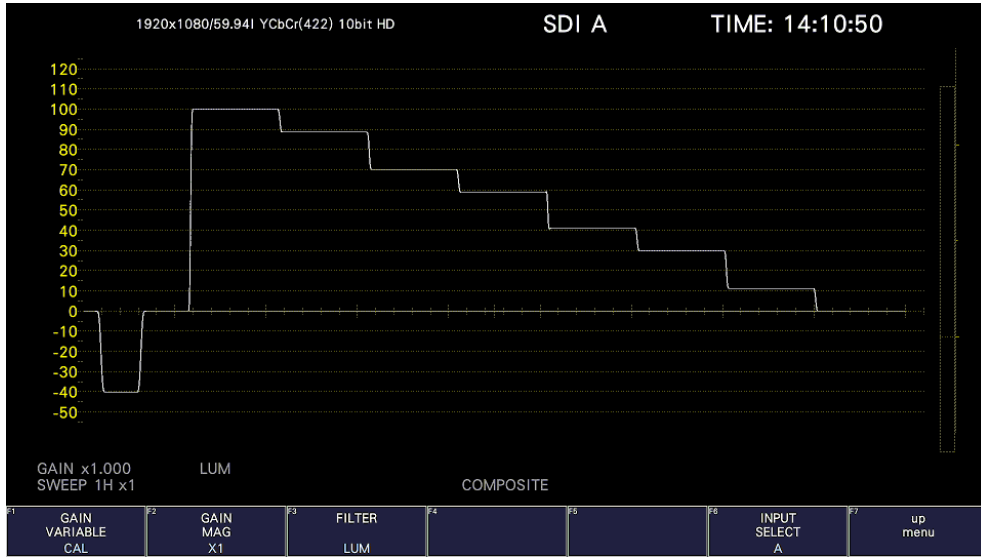

FILTER = FLAT+LUM

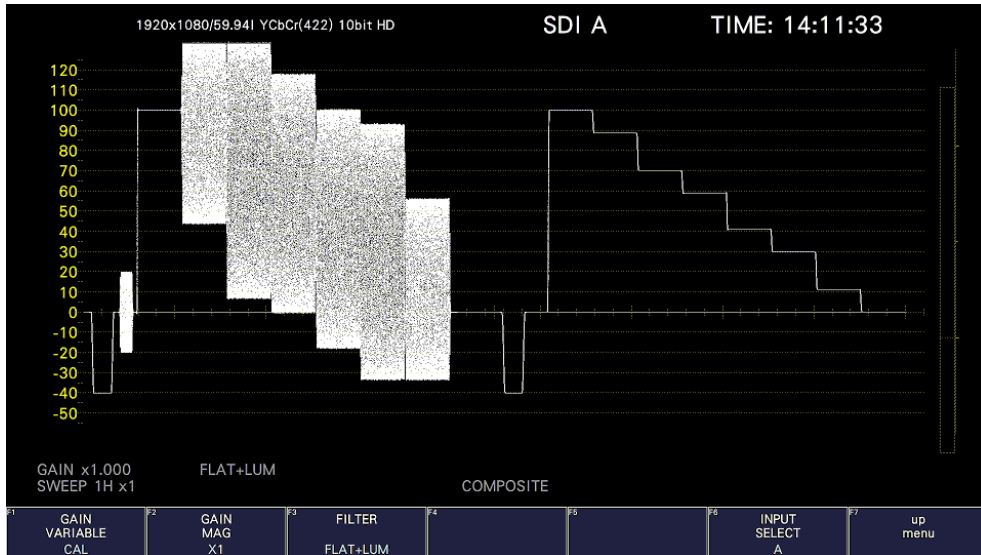

FILTER = LUM+CRMA

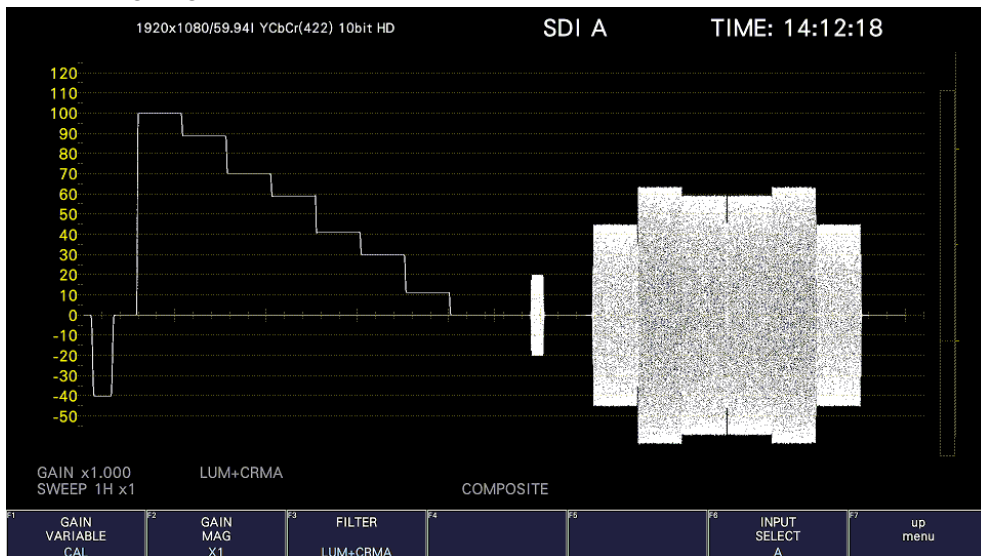

Figure 10-12 Selecting the filter (composite)

10. VIDEO SIGNAL WAVEFORM DISPLAY

10.4.4 Setting the Scale Jump

If **F•2** GAIN MAG is set to X5, the waveform is expanded five times in the Y-axis direction. To select the area you want to see expanded, follow the procedure below. You can view the area that is currently displayed with respect to the entire waveform on the scale shown on the right side of the screen.

This menu item appears when GAIN MAG is set to X5 or X10.

Procedure

WFM → **F•2** GAIN/FILTER → **F•5** SCALE JUMP: 0% / 10% / 20% / 30% / 40% / 50% / 60% / 70% / 80% / 90% / 100% / CURSOR

- 0 to 100%

The instrument has 11 types of screens in the Y-axis direction, these screens are switched in the range of 0 to 100%.

For example, if the scale unit is % and YCbCr is displayed, selecting 0% displays the 0 to 20% range, selecting 10% displays the 10 to 30% range, selecting 90% displays the 90 to 110% range, and selecting 100% displays the 100 to 120% range.

10. VIDEO SIGNAL WAVEFORM DISPLAY

• Cursors

The scale jump function operates based on the Y-axis cursor, and the area near the currently selected cursor (▼ mark) is expanded. An operation example is shown below.

[Preparation]

1. On the CURSOR menu, set **F•1** CURSOR to ON and **F•2** XY SEL to Y.
2. On the GAIN/FILTER menu, set **F•2** GAIN MAG to X5 or X10.
3. Set **F•4** SCALE JUMP to CURSOR.

[Operation]

4. Set **F•2** GAIN MAG to X1.
5. Move the Y-axis cursor to the area you want magnified. (You can move the cursor on the GAIN/FILTER menu. You can switch between REF, DELTA, and TRACK by pressing the function dial (F•D).)
6. Set **F•2** GAIN MAG to X5 or X10 to expand the area near the Y-axis cursor.

SCALE JUMP = CURSOR

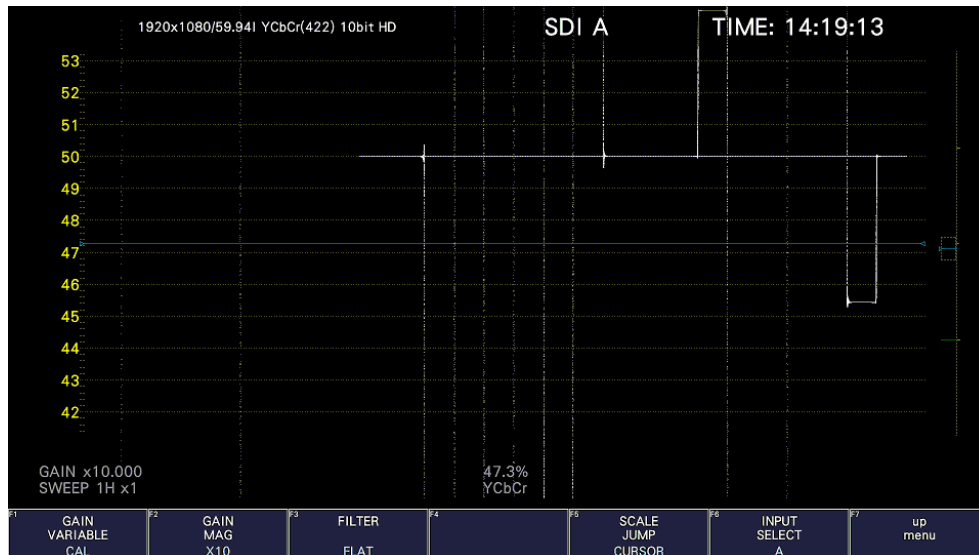

Figure 10-13 Setting the scale jump

10.5 Configuring the Sweep Settings

To configure the sweep settings, press **F•3** SWEEP on the WFM menu.

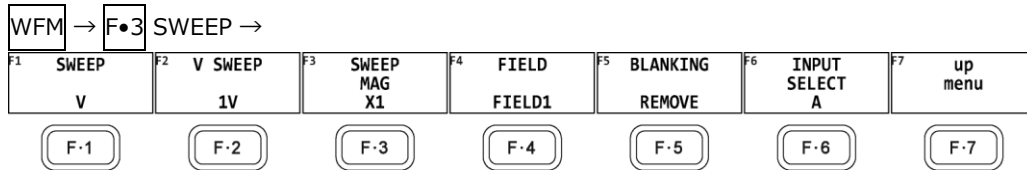

Figure 10-14 SWEEP menu

10.5.1 Selecting the Sweep Method

To select the video signal waveform sweep method, follow the procedure below.

Procedure



Settings

- H: Lines are displayed.
- V: Fields or frames are displayed. Because the sampled data is downsampled, aliasing distortion occurs.

SWEEP = H

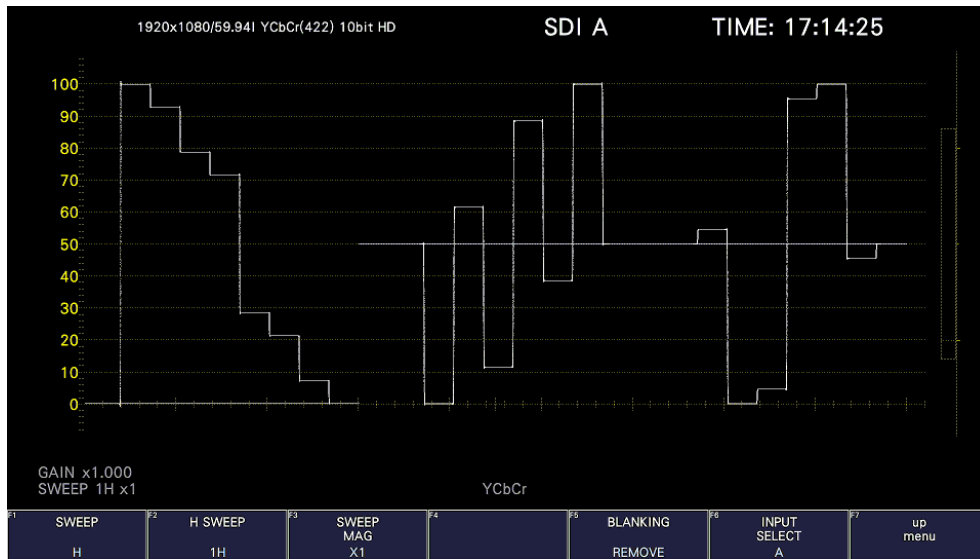

10. VIDEO SIGNAL WAVEFORM DISPLAY

SWEEP = V

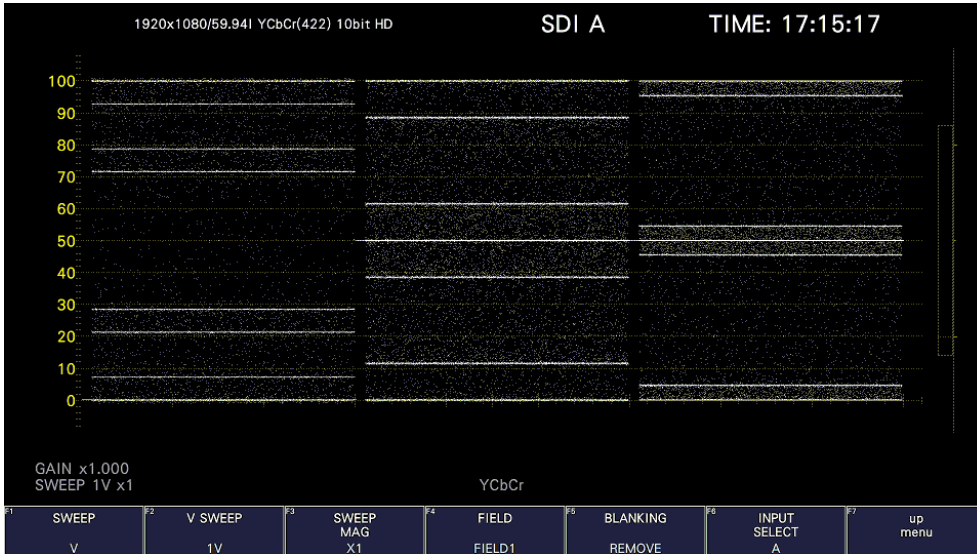

Figure 10-15 Selecting the sweep method

10.5.2 Selecting the Line Display Format

When **F•1** SWEEP is set to H, to select the sweep time, follow the procedure below.

Procedure

WFM → **F•3** SWEEP → **F•2** H SWEEP: 1H / 2H

Settings

1H: One line is displayed.

2H: Two lines are displayed. This cannot be selected in the following situations.

- For 4K
- When **WFM** → **F•1** WFM INTEN/CONFIG → **F•2** WFM MODE → **F•1** MODE is set to PARADE
- When **F•7** COLOR SYSTEM → **F•1** COLOR MATRIX is set to COMPOSITE

H SWEEP = 1H

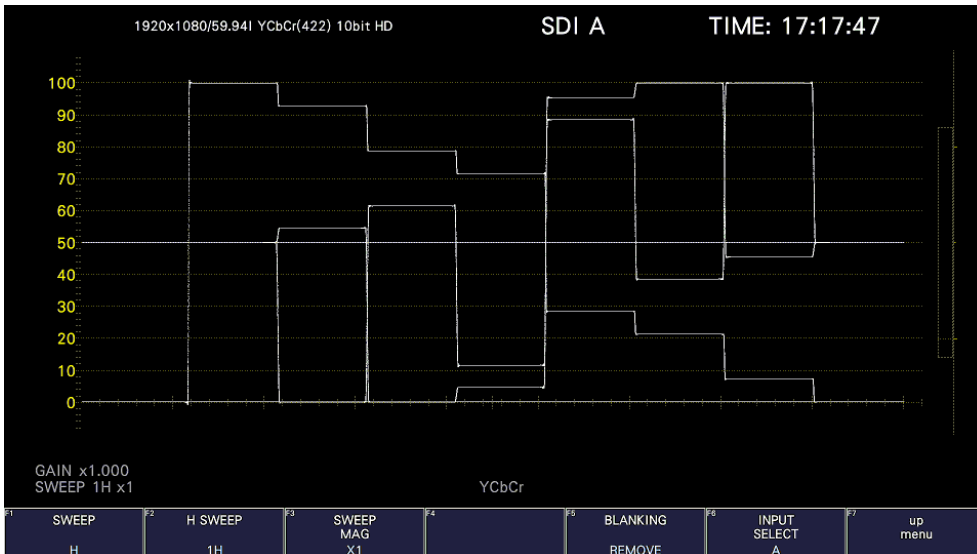

10. VIDEO SIGNAL WAVEFORM DISPLAY

H SWEEP = 2H

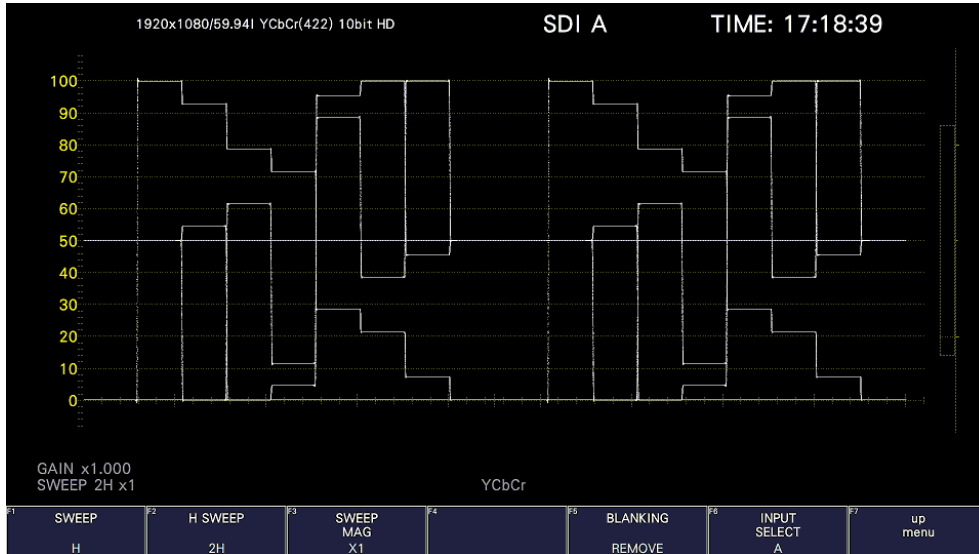

Figure 10-16 Selecting the line display format

10.5.3 Selecting the Field Display Format

When **F•1** SWEEP is set to V, to select the sweep time, follow the procedure below.

Procedure

WFM → **F•3** SWEEP → **F•2** V SWEEP: 1V / 2V

Settings

- 1V: One field is displayed.
- 2V: One frame is displayed. This option cannot be selected when the input signal is progressive.

V SWEEP = 1V

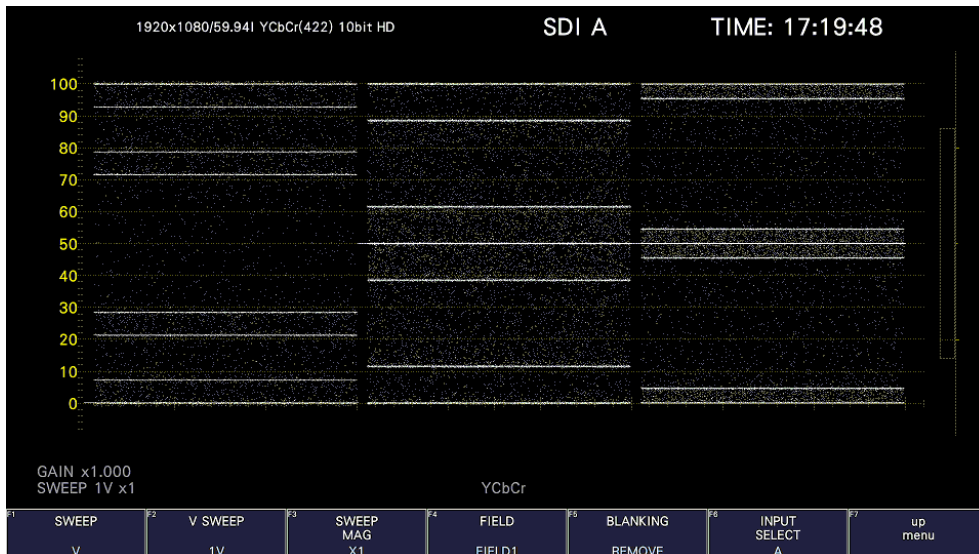

10. VIDEO SIGNAL WAVEFORM DISPLAY

V SWEEP = 2V

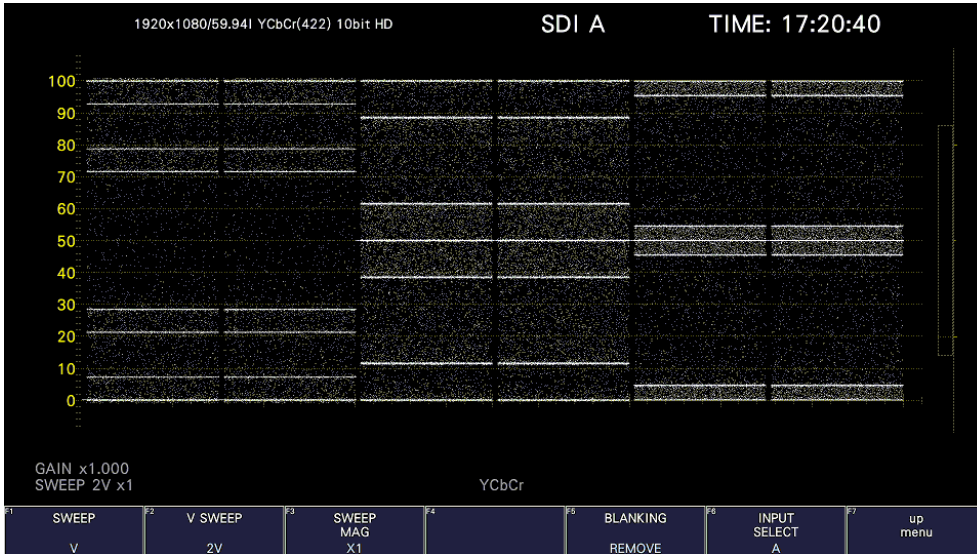

Figure 10-17 Selecting the field display format

Furthermore, when the input signal is interlace or segmented frame and **F•2** V SWEEP is set to 1V, to select which field is displayed, follow the procedure below.

Procedure

WFM → **F•3** SWEEP → **F•4** FIELD: FIELD1 / FIELD2

10.5.4 Selecting the Horizontal Magnification

To select the horizontal magnification, follow the procedure below. The magnifications that you can select vary as shown below depending on settings such as COLOR MATRIX.

[See also] COLOR MATRIX → section 10.8.1, "Selecting the Color Matrix."

You cannot set this when external sync signal waveform display is in use. This is fixed to X1.

Table 10-2 Horizontal magnifications

F•1 SWEEP	COLOR MATRIX	F•2 H SWEEP	X1	X10	X20	X40	ACTIVE	BLANK
H	YCbCr, GBR, RGB	1H	Yes	Yes	Yes	No	Yes	Yes
		2H	Yes	Yes	Yes	No	No	Yes
	COMPOSITE	-	Yes	Yes	Yes	No	Yes	No
V	-	-	Yes	No	Yes	Yes	No	No

(Yes: Settable. No: Not settable.)

10. VIDEO SIGNAL WAVEFORM DISPLAY

Procedure

WFM → F•3 SWEEP → F•3 SWEEP MAG: X1 / X10 / X20 / X40 / ACTIVE / BLANK

Settings

- X1: The video signal waveforms are displayed so that they fit on the screen.
- X10: The video signal waveforms are magnified from the center of the display to 10 times the size of X1.
- X20: The video signal waveforms are magnified from the center of the display to 20 times the size of X1.
- X40: The video signal waveforms are magnified from the center of the display to 40 times the size of X1.
- ACTIVE: Everything but the video signal waveform blanking interval is magnified.
- BLANK: The video signal waveform blanking interval is magnified.

SWEEP MAG = X1

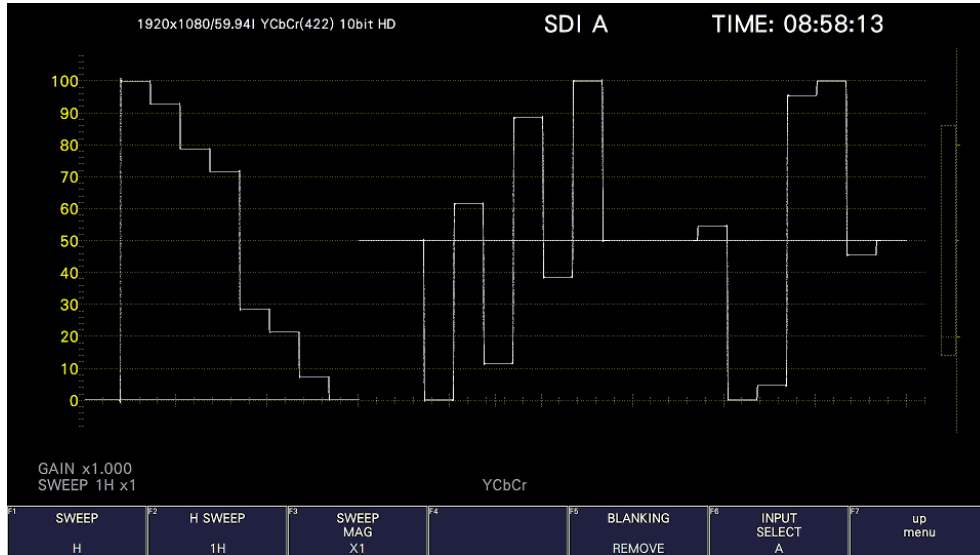

SWEEP MAG = X10

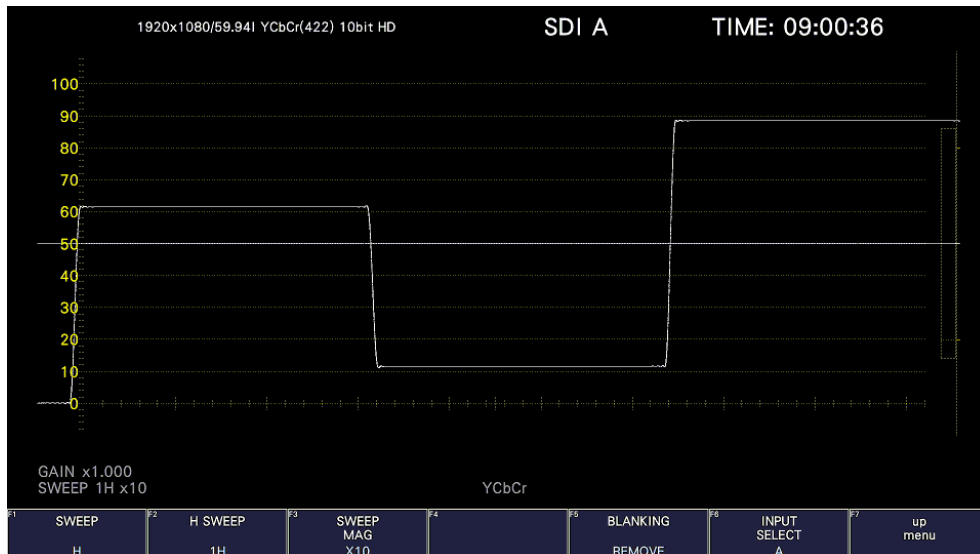

10. VIDEO SIGNAL WAVEFORM DISPLAY

SWEEP MAG = ACTIVE

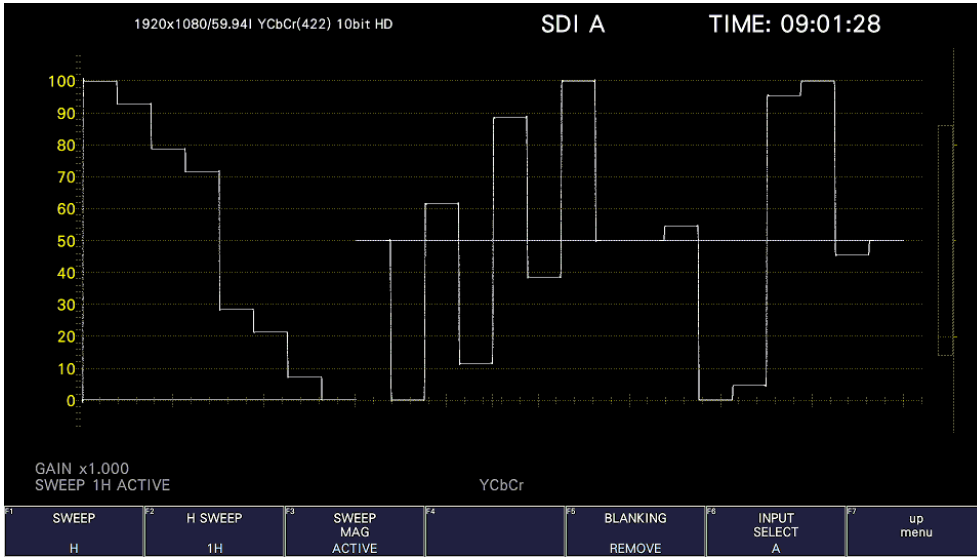

SWEEP MAG = BLANK

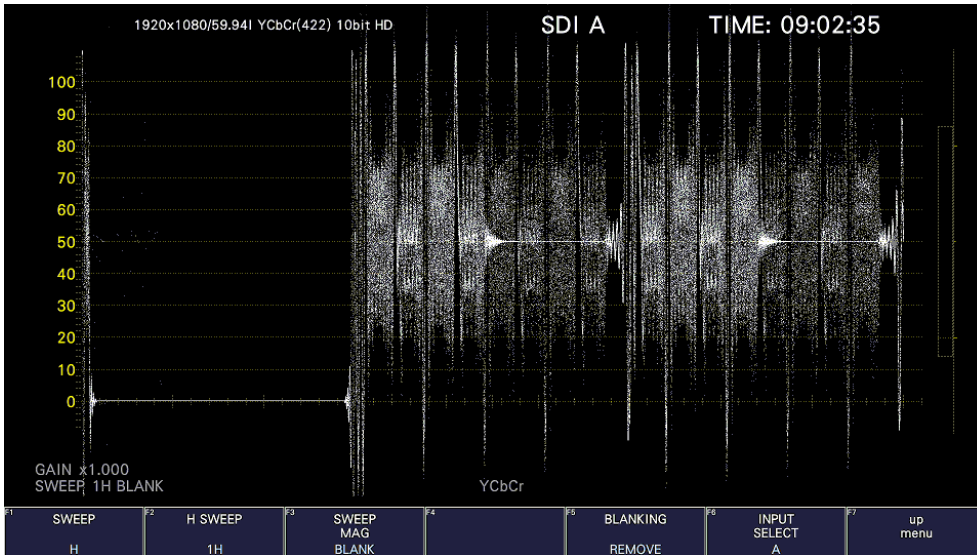

Figure 10-18 Horizontal magnifications

10. VIDEO SIGNAL WAVEFORM DISPLAY

10.5.5 Displaying the Blanking Interval

To set how the waveforms in the blanking interval are displayed, follow the procedure below.

If a setting other than REMOVE is selected, the vertical blanking interval is also displayed on the vector display.

[See also] COLOR MATRIX → section 10.8.1, "Selecting the Color Matrix."

You cannot set this when external sync signal waveform display is in use.

Procedure

WFM	→	F•3	SWEEP	→	F•5	BLANKING: REMOVE / V VIEW / H VIEW / ALL VIEW
-----	---	-----	-------	---	-----	---

Settings

- REMOVE: Only the active interval is displayed.
- V VIEW: The active interval and the vertical blanking interval are displayed.
- H VIEW: The active interval and the horizontal blanking interval are displayed.
This option cannot be selected when COLOR MATRIX is set to COMPOSITE.
- ALL VIEW: The entire input signal is displayed.
This option cannot be selected when COLOR MATRIX is set to COMPOSITE.

BLANKING = ALL VIEW

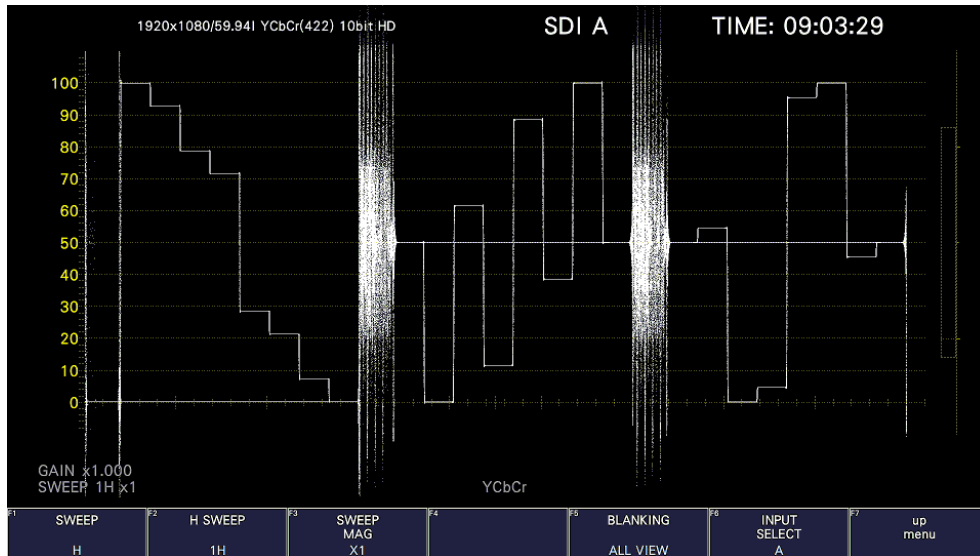

Figure 10-19 Displaying blanking intervals

10.6 Configuring the Cursor Settings

To configure the cursor settings, press **F•4** CURSOR on the WFM menu.

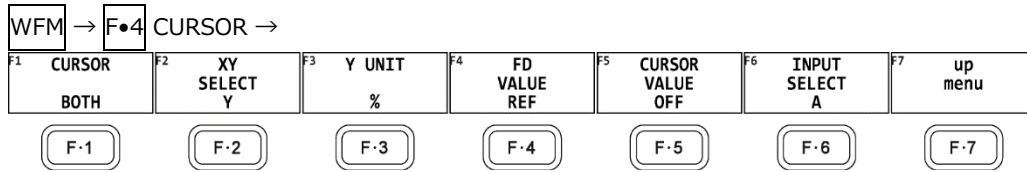

Figure 10-20 CURSOR menu

10.6.1 Turning Cursors On and Off

To turn cursors on and off, follow the procedure shown below.

The REF cursor is displayed in blue, and the DELTA cursor is displayed in green. The value of DELTA - REF appears as a measured value in the lower right of the screen. (When **F•3** Y UNIT is set to DEC or HEX, absolute values are displayed.)

0If BOTH is selected, the X-axis cursors and Y-axis cursors are displayed simultaneously.

Procedure



10.6.2 Selecting the Cursor

To select the X (time measurement) or Y (amplitude measurement) cursor, follow the procedure below.

If **F•1** CURSOR is set to BOTH, select the cursor to move here.

Procedure



XY SELECT = X

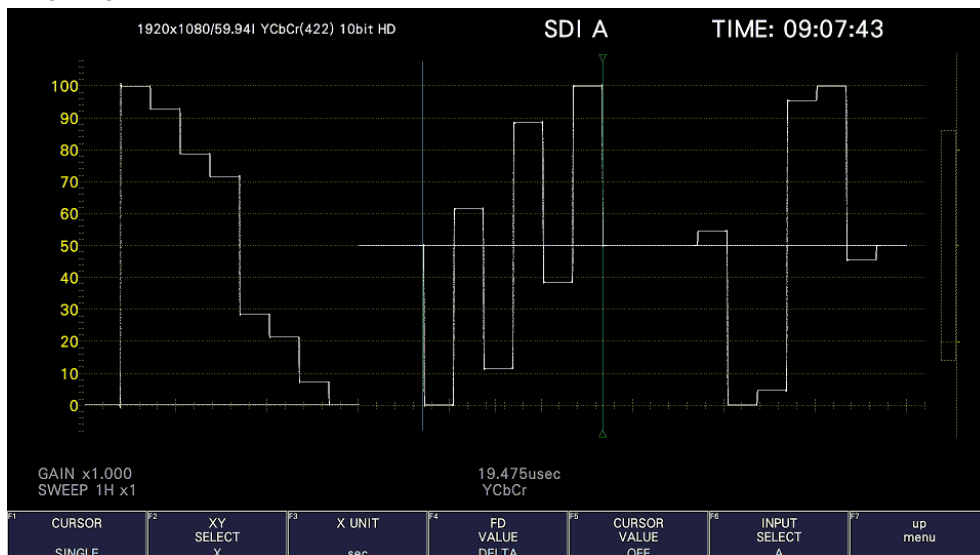

10. VIDEO SIGNAL WAVEFORM DISPLAY

XY SELECT = Y

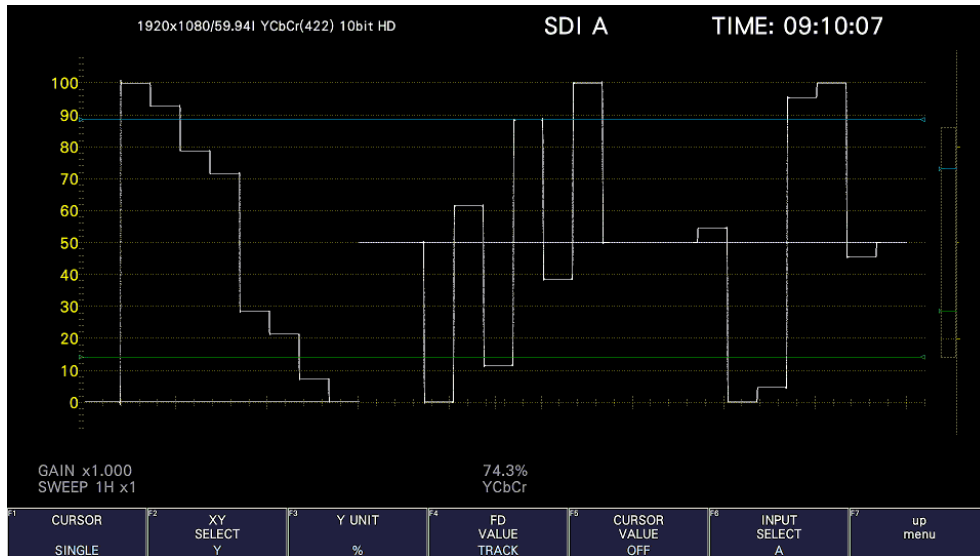

Figure 10-21 Selecting the cursor

10.6.3 Selecting the Y-Axis Measurement Unit

When **F•2** XY SELECT is set to Y, to select the Y-axis cursor measurement unit, follow the procedure below.

When COLOR MATRIX is set to YCbCr, GBR, or RGB, the default value is %.

[See also] COLOR MATRIX → section 10.8.1, “Selecting the Color Matrix.”

Procedure

WFM → **F•4** CURSOR → **F•3** Y UNIT: mV / % / R% / DEC / HEX / HDR

Settings

mV: The measurement unit is volts.

%: The measurement unit is percentage.

When the composite display format is NTSC, 714.3 mV is 100 %. When the composite display format is PAL, 700 mV is 100 %.

R%: The amplitude will be measured as a percentage of the amplitude at the time when you pressed **F•5** REF SET.

DEC: Values are displayed in decimal with 0 to 100 % expressed as 64 to 940. This option cannot be selected when COLOR MATRIX is set to COMPOSITE.

C_BC_R signal measurement is not supported.

HEX: Values are displayed in hexadecimal with 0 to 100 % expressed as 040 to 3AC.

This option cannot be selected when COLOR MATRIX is set to COMPOSITE.

C_BC_R signal measurement is not supported.

HDR: Values are displayed as a percentage or Nits.

You can select this option when SER23 is installed and when HDR signals are being measured.

For details, see section 14.1.4, “Cursor Display.”

10.6.4 Selecting the X-Axis Measurement Unit

When **F•2** XY SELECT is set to X, to select the X-axis cursor measurement unit, follow the procedure below.

Procedure

WFM	→	F•4	CURSOR	→	F•3	X UNIT: <u>sec</u> / Hz
-----	---	-----	--------	---	-----	-------------------------

Settings

sec:	The measurement unit is seconds.
Hz:	The measurement unit is frequency, with the length of one period set to the distance between the two cursors.

10.6.5 Moving the Cursors

To move a cursor, follow the procedure shown below to select a cursor. Then, move the cursor by turning the function dial (F•D). Triangles appear on both ends of the selected cursor.

You can also select a cursor by pressing the function dial (F•D). Each time you press the function dial (F•D), the selected cursor switches from REF, to DELTA, to TRACK, and then back to REF.

Procedure

WFM	→	F•4	CURSOR	→	F•4	FD VALUE: <u>REF</u> / DELTA / TRACK
-----	---	-----	--------	---	-----	--------------------------------------

10. VIDEO SIGNAL WAVEFORM DISPLAY

10.6.6 Turning the Cursor Value Display On and Off

To display cursor values, follow the procedure shown below (except when **F•3** Y UNIT is set to R%).

The display unit is the unit specified with **F•3** Y UNIT or **F•3** X UNIT.

If **F•1** CURSOR is set to BOTH, the value is displayed on the cursor selected with **F•2** XY SELECT.

Procedure

WFM	→	F•4	CURSOR	→	F•5	CURSOR VALUE: ON / OFF
-----	---	-----	--------	---	-----	------------------------

CURSOR VALUE = ON

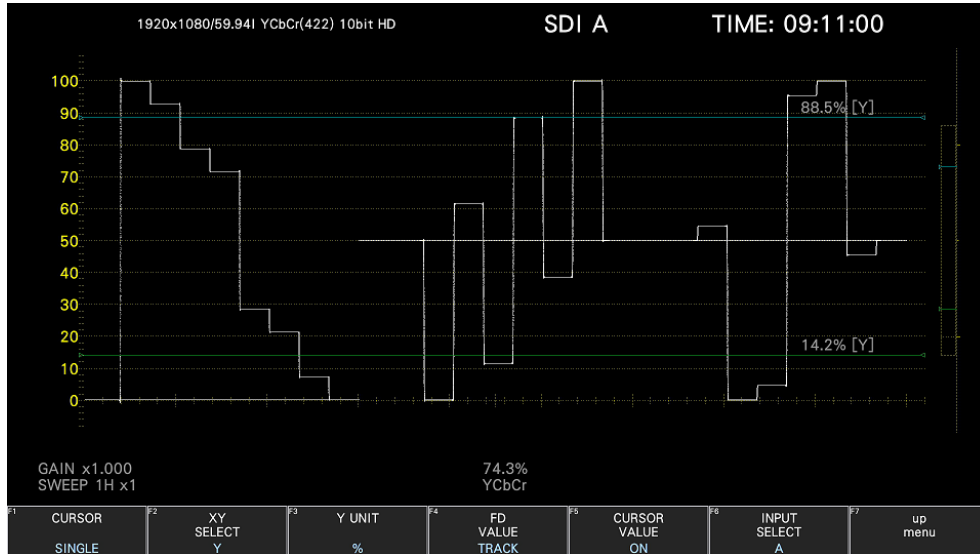
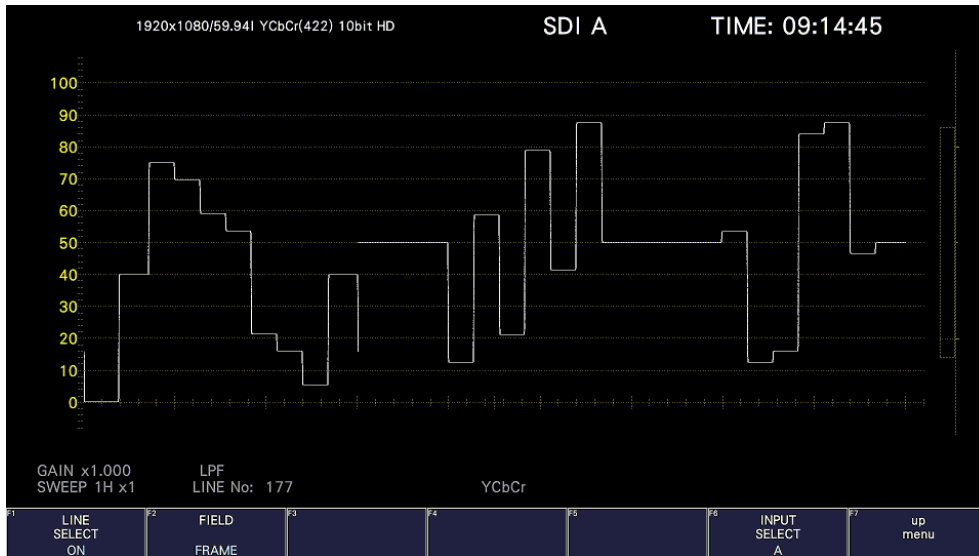

Figure 10-22 Turning the cursor value display on and off

10. VIDEO SIGNAL WAVEFORM DISPLAY

LINE SELECT = ON



LINE SELECT = OFF

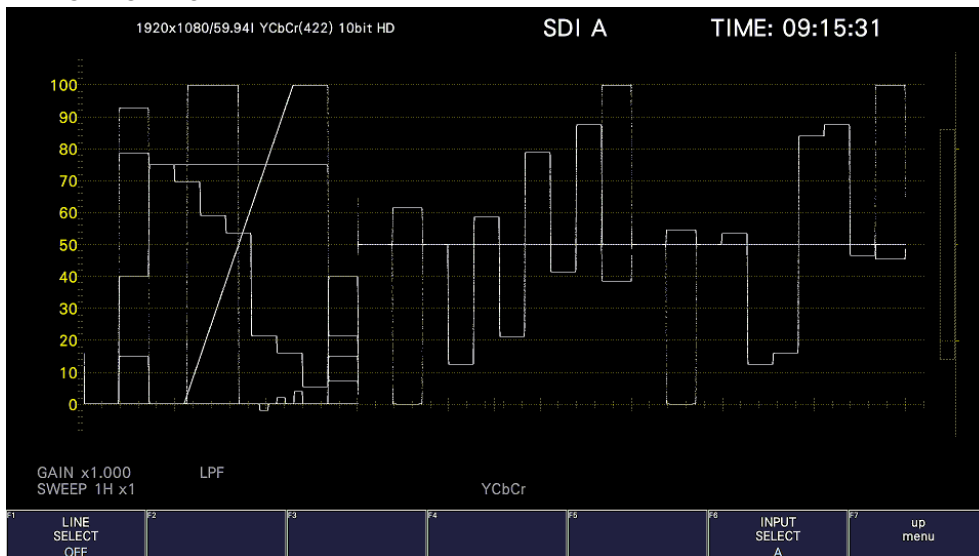

Figure 10-24 Turning line selection on and off

10.7.2 Setting the Line Selection Range

When **F•1** LINE SELECT is set to ON and the input signal format is interlaced or segmented frame, to set the line selection range, follow the procedure below. Changing this setting will also change the selected line on the video-signal-waveform, picture, and status (data dump) displays.

Procedure

VECT → **F•3** LINE SEL → **F•2** FIELD: FIELD1 / FIELD2 / FRAME

Settings

FIELD1:	A line from field 1 can be selected. (Example: 1 to 563)
FIELD2:	A line from field 2 can be selected. (Example: 564 to 1125)
FRAME:	All lines can be selected. (Example: 1 to 1125)

10.8 Configuring the Color System Settings

To configure the color system settings, press **F•7** COLOR SYSTEM on the WFM menu.

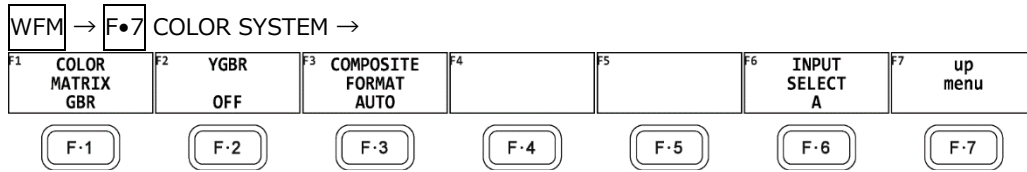

Figure 10-25 COLOR SYSTEM menu

You cannot set these when external sync signal waveform display is in use.

10.8.1 Selecting the Color Matrix

The instrument performs a matrix conversion on an input signal to convert it into a GBR, RGB or pseudo-composite signal. To select the waveform display format, follow the procedure below. The selected display format is indicated in the lower right of the display.

Procedure

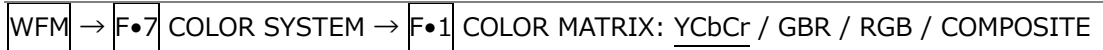

Settings

- YCbCr:** The $Y C_B C_R$ signal is displayed.
This setting cannot be selected when the input signal is RGB.
- GBR:** The input signal is converted into a GBR signal and displayed.
- RGB:** The input signal is converted into a RGB signal and displayed.
- COMPOSITE:**
The input signal is converted into a pseudo NTSC or PAL composite signal and displayed.
 - Color burst frequencies do not match those of PAL and NTSC.
 - Color burst and sync signal widths and locations are different from those of PAL and NTSC.
 - The signal bandwidth is that of the original signal.

COLOR MATRIX = YCbCr

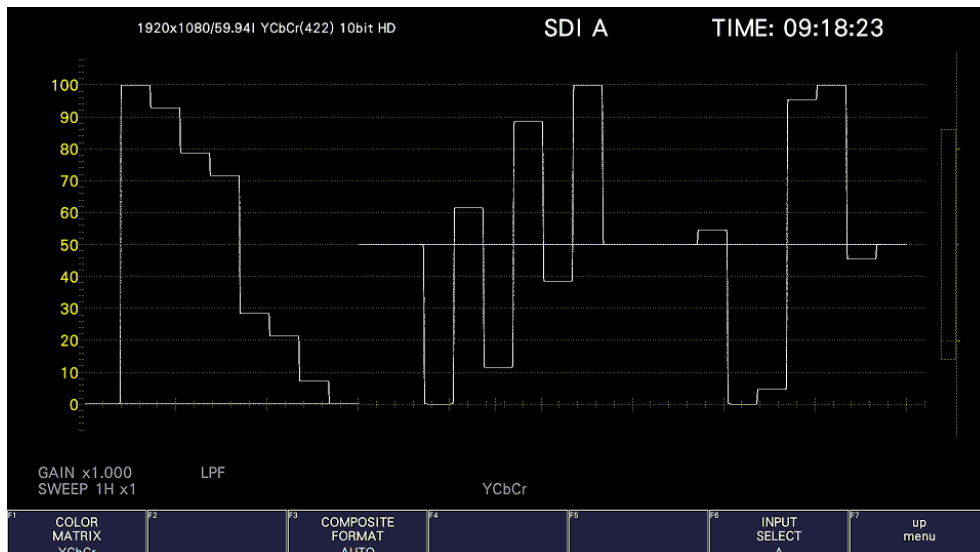

10. VIDEO SIGNAL WAVEFORM DISPLAY

COLOR MATRIX = GBR

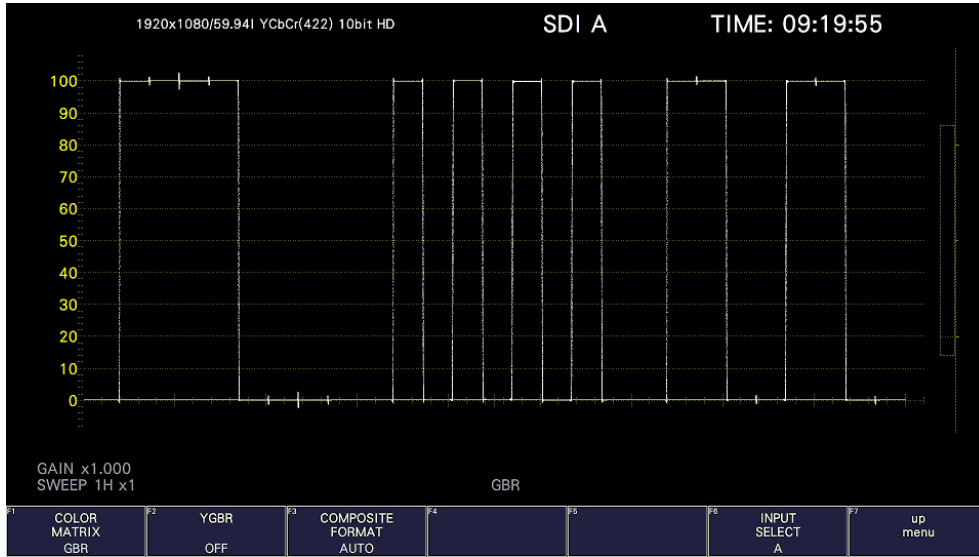

COLOR MATRIX = RGB

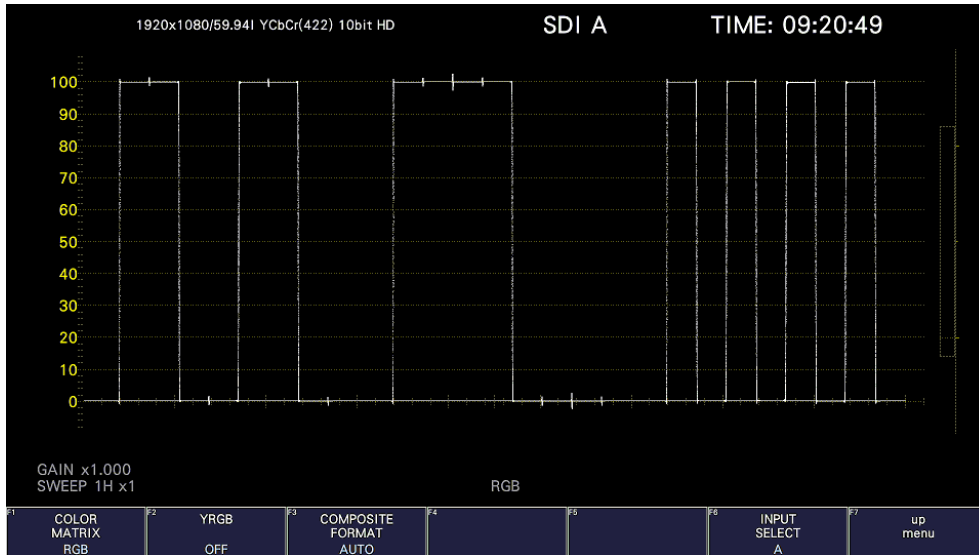

COLOR MATRIX = COMPOSITE

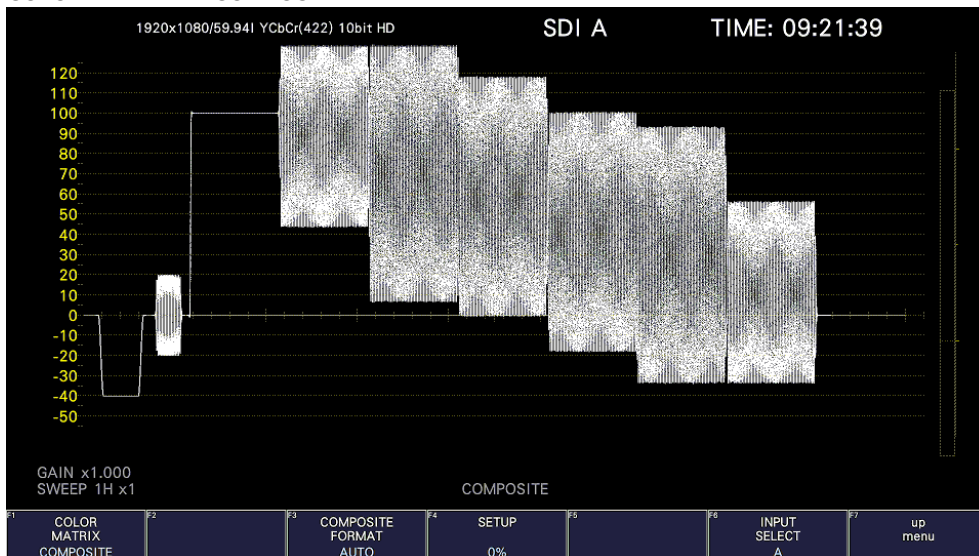

Figure 10-26 Selecting the color matrix

10.8.2 Turning the Luminance Signal On and Off

When **F•1** COLOR MATRIX is set to GBR or RGB, to turn the luminance signal (Y) on and off, follow the procedure below.

Procedure

WFM → **F•7** COLOR SYSTEM
 → **F•2** YGBR: ON / OFF
 → **F•2** YRGB: ON / OFF

YGBR = ON

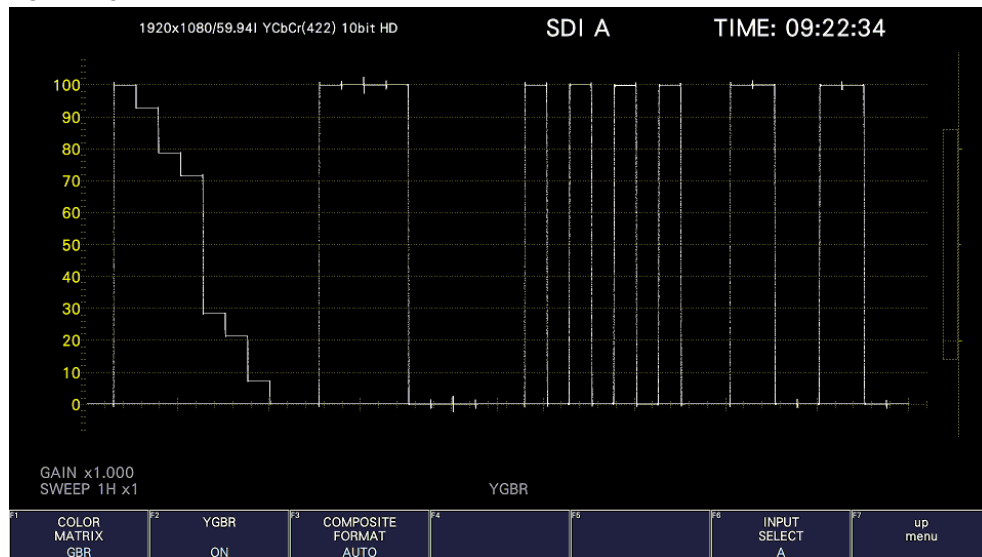

Figure 10-27 Turning the luminance signal on and off

10.8.3 Selecting the Composite Display Format

To select the composite display format, follow the procedure below.

Procedure

WFM → **F•7** COLOR SYSTEM → **F•4** COMPOSITE FORMAT: AUTO / NTSC / PAL

Settings

-
- AUTO: When the input signal frame rate is 25 Hz or 50 Hz, the format is PAL. Otherwise, the format is NTSC.
 - NTSC: The format is NTSC. The scale is fixed to percentage.
 - PAL: The format is PAL. The scale is fixed to V.
-

10. VIDEO SIGNAL WAVEFORM DISPLAY

10.8.4 Selecting the Setup Level

When **F•1** COLOR MATRIX is set to COMPOSITE, to select the setup level, follow the procedure below.

This menu does not appear if the composite display format is PAL.

Procedure

WFM → **F•7** COLOR SYSTEM → **F•5** SETUP: 0% / 7.5%

SETUP = 7.5%

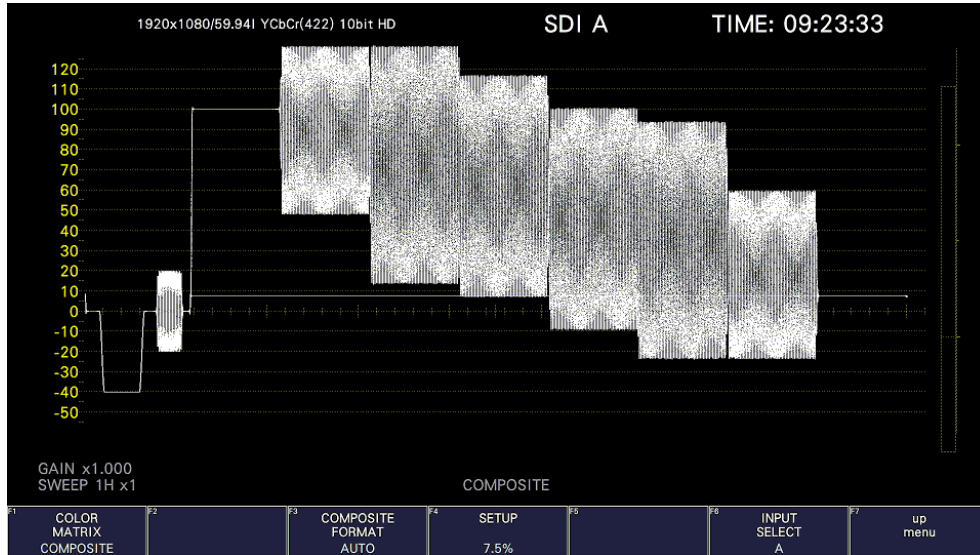

Figure 10-28 Selecting the setup level

10.9 Displaying the External Sync Signal Waveform

When **F•1** EXTERNAL SYNC is set to ON on the WFM INTEN/CONFIG menu, the external sync signal waveform and the EXTERNAL SYNC menu appear.

When SDI System is set to 2K HD Dual Link, 2K 3G Dual Link, or 2K 3G-B DS on the SYS menu, the external sync signal waveform cannot be displayed.

[See also] SDI System → 7.1.1, "Configuring the Input System."

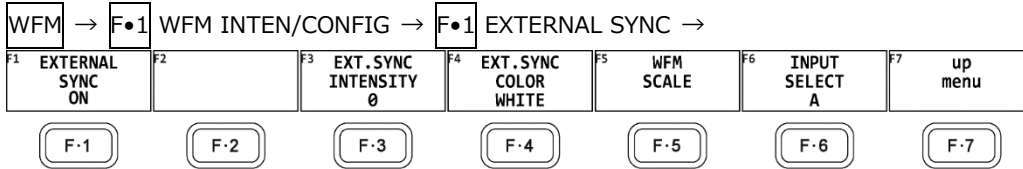

Figure 10-29 EXTERNAL SYNC menu

10.9.1 Adjusting the Waveform Intensity

To adjust the video signal waveform intensity, follow the procedure below.
Press the function dial (F•D) to return the setting to its default value (0).

Procedure



10.9.2 Selecting the Waveform Color

To select the external sync signal waveform color, follow the procedure below.

Procedure

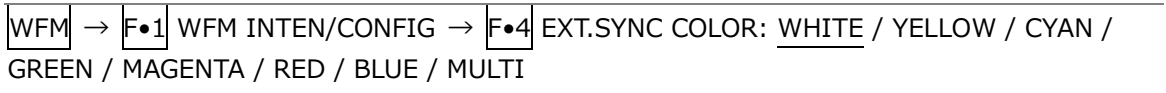

10.9.3 Adjusting the Scale Intensity

To configure the scale, press **F•5** WFM SCALE on the WFM INTEN/CONFIG menu.

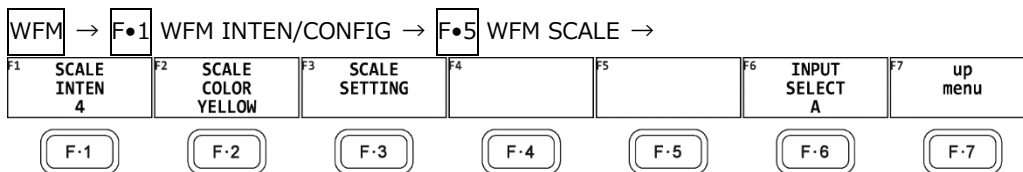

Figure 10-30 WFM SCALE menu

To adjust the scale intensity, follow the procedure below.
Press the function dial (F•D) to return the setting to its default value (4).

Procedure



10. VIDEO SIGNAL WAVEFORM DISPLAY

10.9.4 Selecting the Scale Color

To select the scale color, follow the procedure below.

Procedure

WFM → F•1 WFM INTEN/CONFIG → F•5 WFM SCALE → F•2 SCALE COLOR: WHITE /
YELLOW / CYAN / GREEN / MAGENTA / RED / BLUE

10.9.5 Selecting the Scale Unit

When the external sync signal is NTSC, this is fixed to %. When the external sync signal is HD or PAL, this is fixed to V.

Procedure

WFM → F•1 WFM INTEN/CONFIG → F•5 WFM SCALE → F•3 SCALE SETTING
→ F•1 SCALE UNIT: % (when the external sync signal is NTSC)
→ F•1 SCALE UNIT: V (when the external sync signal is HD or PAL)

10.9.6 Displaying the Scale

To turn the scale display on and off, follow the procedure shown below.

Procedure

WFM → F•1 WFM INTEN/CONFIG → F•5 WFM SCALE → F•3 SCALE SETTING → F•3
SCALE DISPLAY: ON / OFF

11. VECTOR DISPLAY

To display vectors, press VECT, **F•1** VECT INTEN/CONFIG, and then **F•1** VECTOR DISPLAY to select VECTOR.

When VECTOR DISPLAY is set to 5BAR, see 11.12 “5-Bar Display,” for the explanation. When set to HISTOGRAM, see 11.13, “Histogram Display,” for the explanation. When VECTOR DISPLAY is set to CIE, see 12, “CIE Chromaticity Diagram Display,” for the explanation.

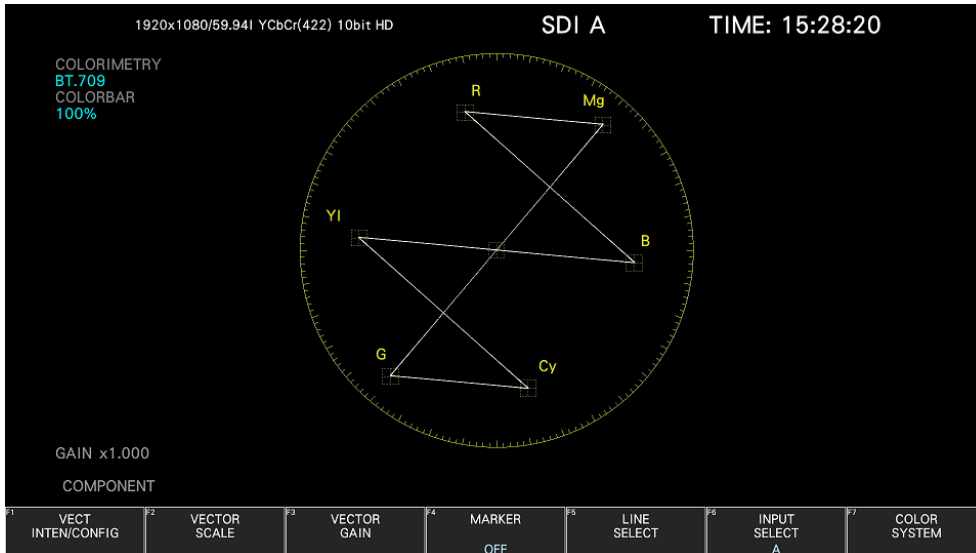

Figure 11-1 Vector display

- Vectors

Component signal vector displays are X-Y displays based on C_B (horizontal) and C_R (vertical). The vector display scale has the following qualities.

- Frame: $\pm 5\%$ of the full scale value 0.7 V (during component display) (*1)
 $\pm 3\%$ of the full scale value 0.7 V (For the pseudo-composite display when VARIABLE SCALE is set to off)
- Circle: $+20\%$ with respect to green (For the pseudo-composite display when VARIABLE SCALE is set to off)

*1 The variable scale is set to on, it can be varied from 5% ($\pm 2.5\%$) to 10% ($\pm 5\%$).

- Blanking interval

Normally, blanking interval is not displayed with vectors, but if SWEEP MAG is set to BLANK on the WFM menu or BLANKING is set to REMOVE, it is displayed.

- Colorimetry

The colorimetry selected on the SYS menu is displayed in cyan in the upper left of the screen. However, for 3G(DL)-4K and 3G(QL), the current applied colorimetry is displayed in yellow if the colorimetry information of all links specified by the payload ID are not matched. When the colorimetry alarm on the SYS menu is set to on and a colorimetry different from the one specified is received, the alarm is indicated in red.

[See also] Colorimetry alarm → 7.1.4, “Setting the Input Format and Format Alarm”

11. VECTOR DISPLAY

- Scale

The scale selected with COLOR BAR on the COLOR SYSTEM menu is displayed in cyan in the COLORBAR on the upper left of the screen.

[See also] COLOR BAR → 11.11.2, "Displaying a Scale for 75% Color Bars"

11.1 Operation Key Description

On the LV5600, operation keys other than S-CUT can be controlled from the mouse and touch panel. On the LV7600, keys can be controlled from the panel, mouse, and touch panel. On the vector display, you can press the operation keys to change the following settings. (Some settings may not be changed.) The key LEDs light when the underlined setting is selected.

Key assignments can be changed freely on the OPERATION KEY tab.

[See also] OPERATION KEY tab → 7.2.15, "Setting the Operation keys"

Table 11-1 Operation Key Actions

	Setting
FORM	COMPONENT / COMPOSITE
OVLAY	Disabled
FILTER	Disabled
GAIN	CAL / VARIABLE
MAG (GAIN)	X1 / X5 / IQ-MAG
SWEEP	Disabled
MAG (SWEEP)	Disabled

11.2 Setting the Display and Waveform Intensity

To configure the display and waveform intensity settings, press **F•1** VECT INTEN/CONFIG on the VECT menu.

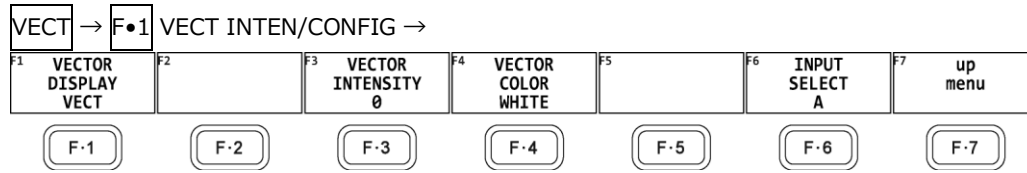

Figure 11-2 VECT INTEN/CONFIG menu

11.2.1 Switching the Display Mode

To select the display mode, follow the procedure below.

Procedure

VECT → F•1 VECT INTEN/CONFIG → F•1 VECTOR DISPLAY: VECTOR / 5BAR / HISTOGRAM / CIE DIAGRAM

Settings

- VECTOR: Shows vectors, RGB vectors (SER40), or YCbCr vectors (SER40).
- 5BAR: Switches to the 5-bar display.
For details, see section 11.12, "5-Bar Display."
- HISTOGRAM: A histogram is displayed.
For details, see section 11.13, "Histogram Display."
- CIE DIAGRAM: The CIE chromaticity diagram display is shown.
For details, see section 12, "CIE Chromaticity Diagram Display."

11. VECTOR DISPLAY

11.2.2 Selecting the Vector Mode (SER40)

When the SER40 is installed, you can select the vector mode, follow the procedure below.

The RGB VECTOR display consists of two factors. One is displayed the G and B components of 100% color bar signal as unit vector on in the upper half of the measurement screen, and the other is displayed the G and R components of the 100% color bar signal as the unit vector in the lower half of the measurement screen. Each vertical axis shows the $G + B$ and $-(G + R)$ of the 100% color bar signal, which is useful for monitoring the color conditions, including the gamut errors.

The YCbCr VECTOR display shows the Cb signal as the horizontal axis and the Y signal as the vertical axis in the upper half of the measurement screen, and the Cr signal as the horizontal axis and the inverted Y signal as the vertical axis in the lower half of the measurement screen. The luminance (Y signal) amplitude can be checked by the deviation in the vertical axis direction from the center of each marker. The chrominance (Cb / Cr signal) amplitude can be checked by the deviation in the horizontal axis direction from the center of each marker.

Procedure

VECT → **F.1** VECT INTEN/CONFIG → **F.2** VECTOR MODE: VECTOR / RGB VECTOR / YCbCr VECTOR

Settings

VECTOR: Shows vectors.
RGB VECTOR: Shows RGB vectors.
YCbCr VECTOR: Shows YCbCr vectors.

VECTOR MODE = VECTOR

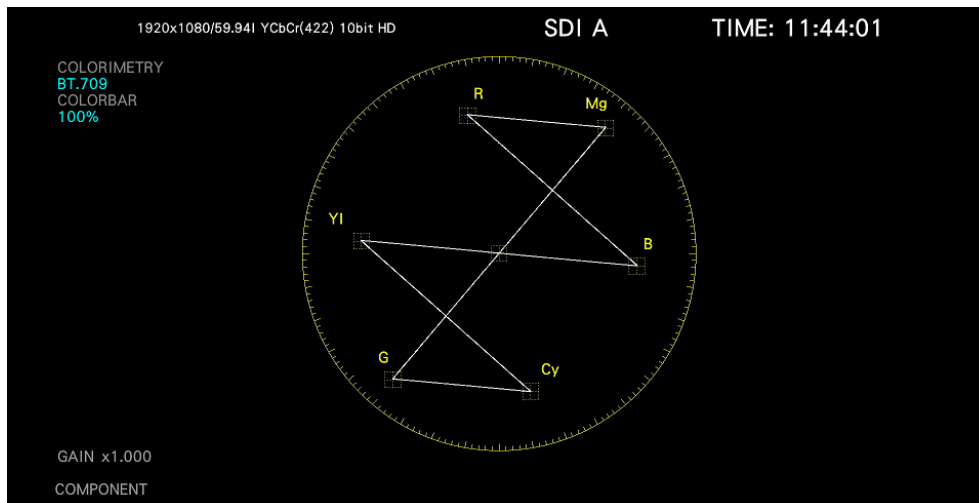

11. VECTOR DISPLAY

VECTOR MODE = RGB VECTOR

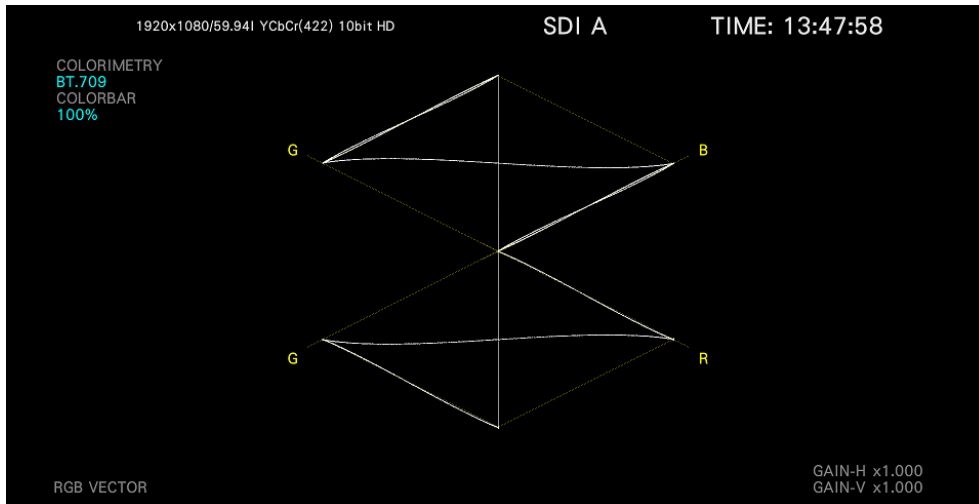

VECTOR MODE = YCbCr VECTOR

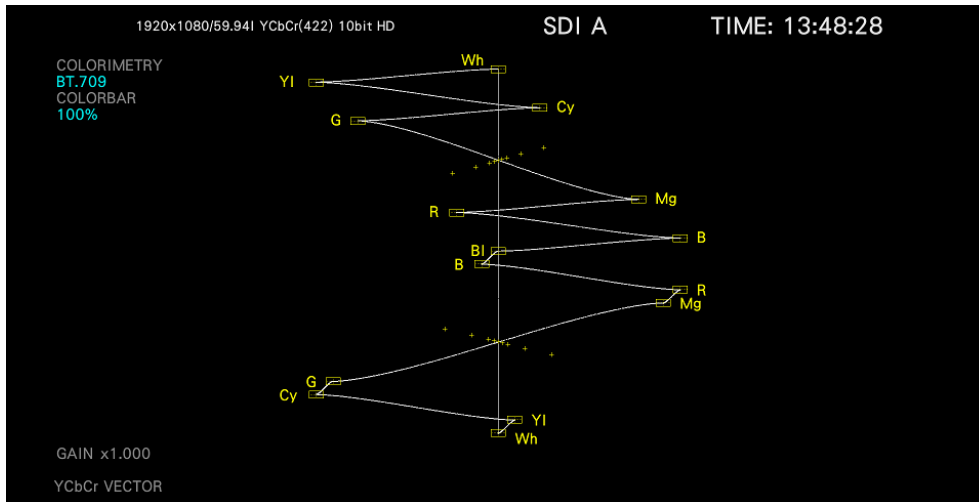

Figure 11-3 Vector mode

11. VECTOR DISPLAY

11.2.3 Adjusting the Waveform Intensity

To adjust the vector intensity, follow the procedure below.

Press the function dial (F•D) to return the setting to its default value (0).

Procedure

VECT → F•1 VECT INTEN/CONFIG → F•3 VECTOR INTENSITY: -128 - 0 - 127

11.2.4 Selecting the Waveform Color

To select the vector color, follow the procedure below.

Procedure (a signal other than 2K 3G-B DS)

VECT → F•1 VECT INTEN/CONFIG → F•2 VECTOR COLOR: WHITE / YELLOW / CYAN / GREEN / MAGENTA / RED / BLUE

Procedure (2K 3G-B DS)

VECT → F•1 VECT INTEN/CONFIG → F•2 VECTOR COLOR
→ F•1 STREAM1 COLOR: WHITE / YELLOW / CYAN / GREEN / MAGENTA / RED / BLUE / MULTI
→ F•2 STREAM2 COLOR: WHITE / YELLOW / CYAN / GREEN / MAGENTA / RED / BLUE / MULTI

11. VECTOR DISPLAY

11.2.5 Configuring the 3G-B DS Display

When measuring 3G-B DS, to select the display mode, follow the procedure below.

Procedure

VECT → **F•1** VECT INTEN/CONFIG → **F•5** 3G-B-DS DISPLAY: STREAM1 / STREAM2 / MIX / ALIGN

Settings

STREAM1: Stream 1 is displayed.
 STREAM2: Stream 2 is displayed.
 MIX: Streams 1 and 2 are displayed on top of each other.
 ALIGN: Streams 1 and 2 are displayed side by side.

3G-B-DS DISPLAY = MIX

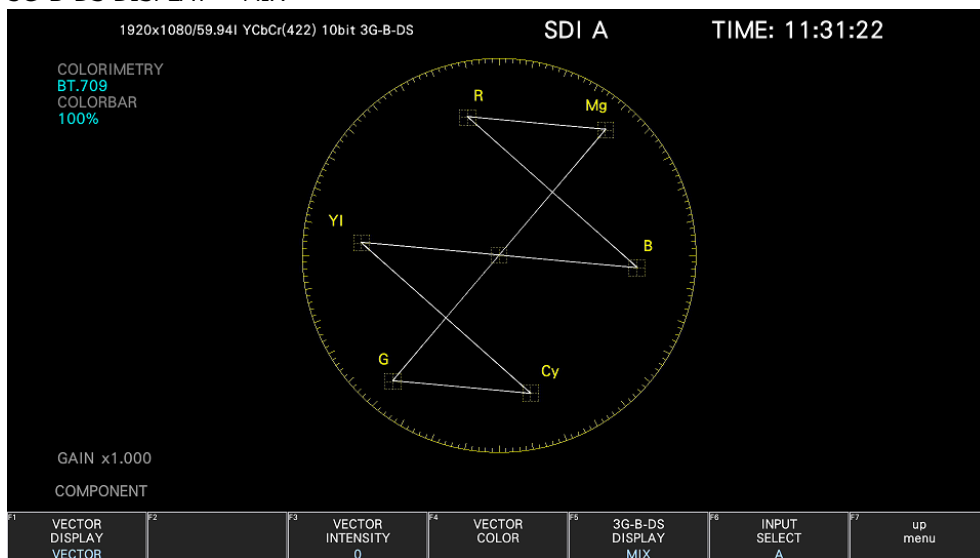

3G-B-DS DISPLAY = ALIGN

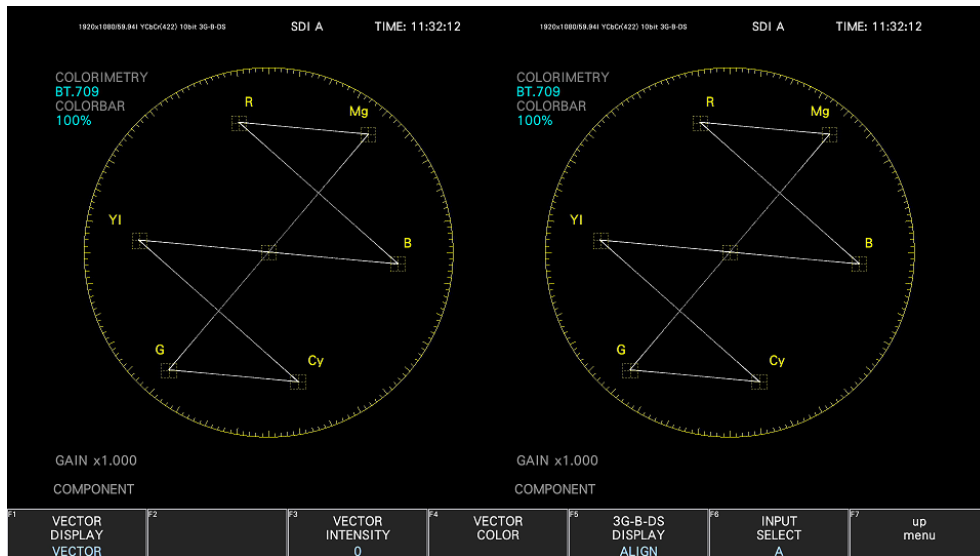

Figure 11-4 Configuring the 3G-B DS Display

11.3 Setting the Vector Scale

To configure the scale, use **F•2** VECTOR SCALE on the VECT menu.

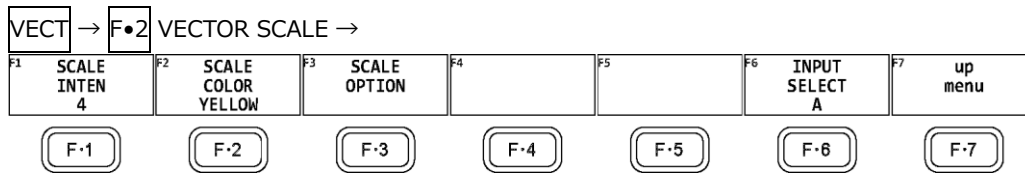

Figure 11-5 VECTOR SCALE menu

11.3.1 Adjusting the Scale Intensity

To adjust the scale intensity, follow the procedure below.

Press the function dial (F•D) to return the setting to its default value (4).

Procedure



11.3.2 Selecting the Scale Color

To select the scale color, follow the procedure below.

Procedure



11.3.3 Turning the Color Wheel On and Off

To configure the scale option, use **F•3** SCALE OPTION on the VECTOR SCALE menu.

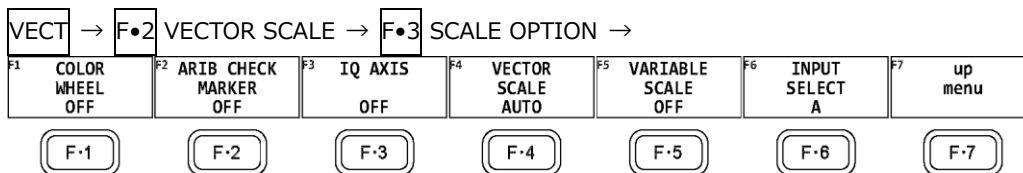
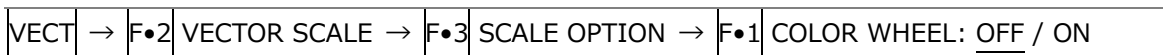

Figure 11-6 SCALE OPTION menu

When VARIABLE SCALE is set to off, COLOR WHEEL (Hue circle) display can be turn on or off, follow the procedure below.

Procedure



11. VECTOR DISPLAY

COLOR WHEEL = ON

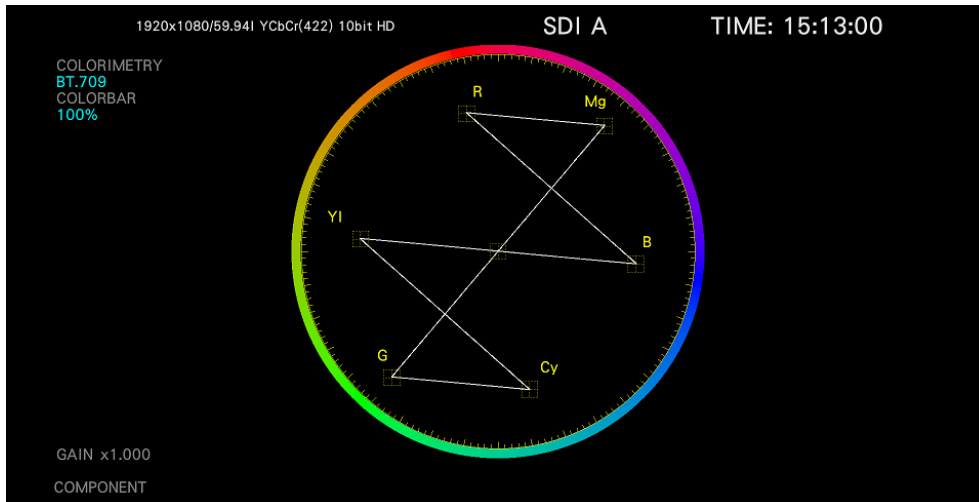

Figure 11-7 Turning the color wheel on and off

11.3.4 ARIB Check Marker

When VARIABLE SCALE is set to on and VECTOR SCALE is set to BT.2020, the ARIB check marker can be displayed on the vector waveform follow the procedure below.

[See also] VARIABLE SCALE → 11.3.7, "Turning the Variable Scale On and Off."

Procedure

VECT → F•2 VECTOR SCALE → F•3 SCALE OPTION → F•2 ARIB CHECK MARKER: OFF / STD-B66 / STD-B72

ARIB CHECK MARKER = STD-B72

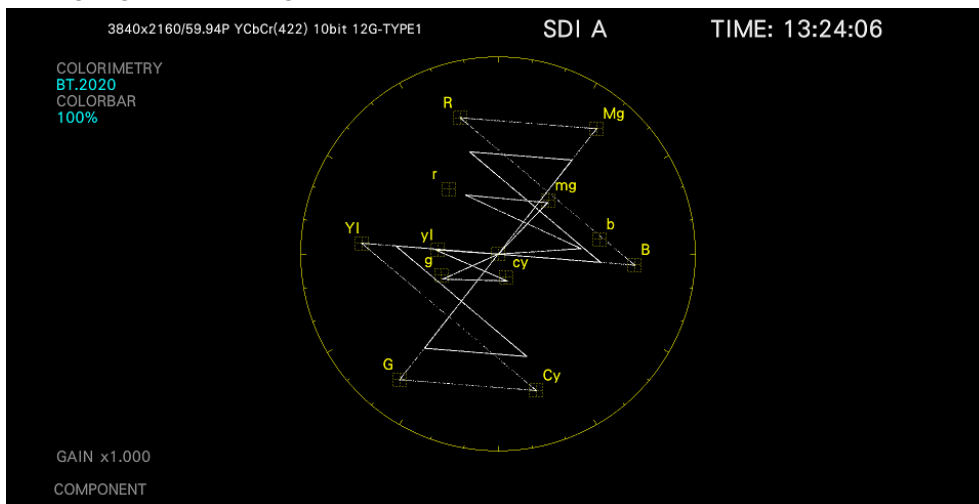

Figure 11-8 ARIB check marker

11. VECTOR DISPLAY

11.3.5 Turning the I and Q Axes On and Off

To turn the I and Q axes on and off, follow the procedure below.

This menu item does not appear when VECTOR SCALE is set to DCI or BT.2020.

When the full scale value of 0.7 V is 100 %, the I and Q axes are displayed at the following values.

Table 11-2 Displaying the I and Q axes

	I Axis	Q Axis
G	44.559 %	37.056 %
B	27.865 %	84.085 %
R	69.120 %	62.417 %

Procedure

VECT	→	F•2	VECTOR SCALE	→	F•3	SCALE OPTION	→	F•3	IQ AXIS: ON / <u>OFF</u>
------	---	-----	--------------	---	-----	--------------	---	-----	--------------------------

IQ AXIS = ON

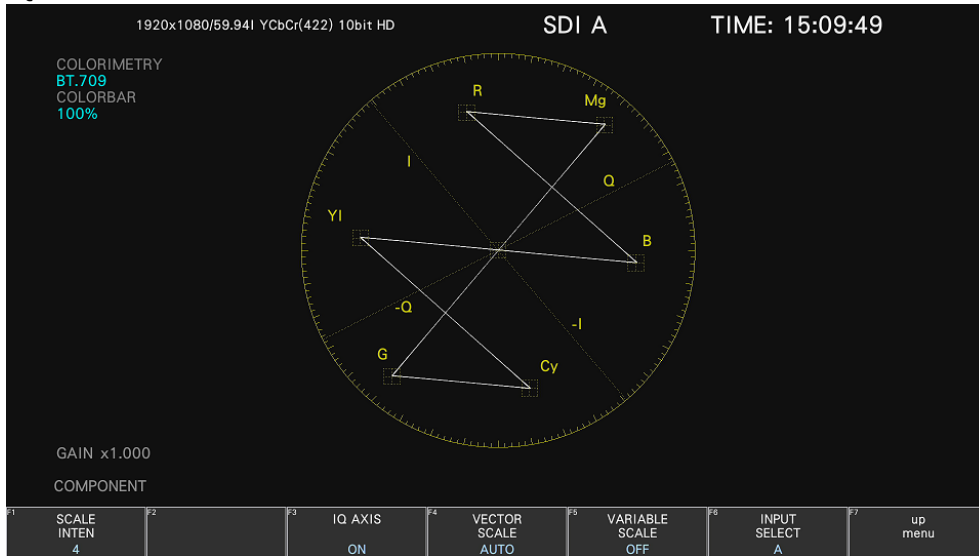

Figure 11-9 Turning the I and Q axes on and off

11. VECTOR DISPLAY

11.3.6 Selecting the Scale

When COLOR MATRIX is set to COMPONENT, follow the procedure below to select the scale type.

[See also] COLOR MATRIX → section 11.11.1, "Selecting the Color Matrix."

Procedure

VECT → **F•2** VECTOR SCALE → **F•3** SCALE OPTION → **F•4** VECTOR SCALE: AUTO / BT.601 / BT.709 / DCI / BT.2020

Settings

AUTO:	A scale for the colorimetry selected on the SYS menu is displayed.
BT.601:	A scale defined in ITU-R BT.601 is displayed. When the input signal is SD and a 100 % color bar signal is being applied, the peak levels match the ends of the scale.
BT.709:	A scale defined in ITU-R BT.709 is displayed. When the input signal is HD and a 100 % color bar signal is being applied, the peak levels match the ends of the scale.
DCI:	A scale defined in DCI is displayed.
BT.2020:	A scale defined in ITU-R BT.2020 is displayed. When the input signal is 4K, the division transmission system is 2 sample interleave, and a 100% color bar signal is being applied, the peak levels match the ends of the scale.

11.3.7 Turning the Variable Scale On and Off

To turn the variable scale on and off, follow the procedure below. When set to on, the variable marker display is valid.

When set to on, IQ-MAG cannot be selected for GAIN MAG.

Procedure

VECT → **F•2** VECTOR SCALE → **F•3** SCALE OPTION → **F•5** VARIABLE SCALE: ON / OFF

11.4 Setting the RGB Vector Scale (SER40)

When the SER40 is installed and the vector mode is set to RGB VECTOR, you can configure the scale, use **F•2** RGB VECTOR SCALE on the VECT menu.

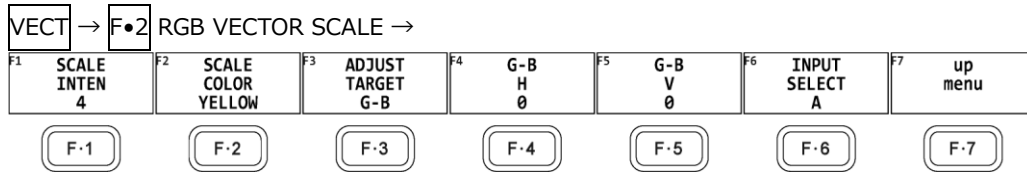

Figure 11-10 RGB VECTOR SCALE menu

11.4.1 Adjusting the Scale Intensity

To adjust the scale intensity, see section 11.3.1, "Adjusting the Scale Intensity."

11.4.2 Selecting the Scale Color

To select the scale color, see section 11.3.2, "Selecting the Scale Color."

11.4.3 Selecting the Adjust Target

To select the adjust target, follow the procedure below.

Procedure

VECT	→	F•2	RGB VECTOR SCALE	→	F•3	ADJUST TARGET: <u>G-B</u> / G-R
------	---	------------	------------------	---	------------	---------------------------------

11.4.4 Adjusting the G-B H / G-R H

To adjust the G-B H / G-R H, follow the procedure below.

Procedure (When the adjust target is set to G-B)

VECT	→	F•2	RGB VECTOR SCALE	→	F•4	G-B H: -500 - <u>0</u> - 500
------	---	------------	------------------	---	------------	------------------------------

Procedure (When the adjust target is set to G-R)

VECT	→	F•2	RGB VECTOR SCALE	→	F•4	G-R H: -500 - <u>0</u> - 500
------	---	------------	------------------	---	------------	------------------------------

11.4.5 Adjusting the G-B V / G-R V

To adjust the G-B V / G-R V, follow the procedure below.

Procedure (When the adjust target is set to G-B)

VECT	→	F•2	RGB VECTOR SCALE	→	F•5	G-B V: -500 - <u>0</u> - 500
------	---	------------	------------------	---	------------	------------------------------

Procedure (When the adjust target is set to G-R)

VECT	→	F•2	RGB VECTOR SCALE	→	F•5	G-R V: -500 - <u>0</u> - 500
------	---	------------	------------------	---	------------	------------------------------

11.5 Setting the YCbCr Vector Scale (SER40)

When the SER40 is installed and the vector mode is set to YCbCr VECTOR, you can configure the scale, use **F•2** YCbCr VECTOR SCALE on the VECT menu.

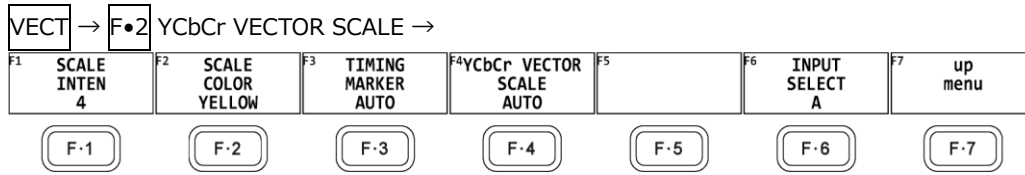

Figure 11-11 YCbCr VECTOR SCALE menu

11.5.1 Adjusting the Scale Intensity

To adjust the scale intensity, see section 11.3.1, "Adjusting the Scale Intensity."

11.5.2 Selecting the Scale Color

To select the scale color, see section 11.3.2, "Selecting the Scale Color."

11.5.3 Selecting the Timing Marker

To select the timing marker, follow the procedure below.

Procedure

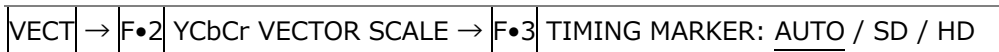

11.5.4 Selecting the YCbCr Vector Scale

To select the scale, see section 11.3.6, "Selecting the Scale."

11.6 Setting the Vector Gain

To set the gain, press **F•3** VECTOR GAIN on the VECT menu.

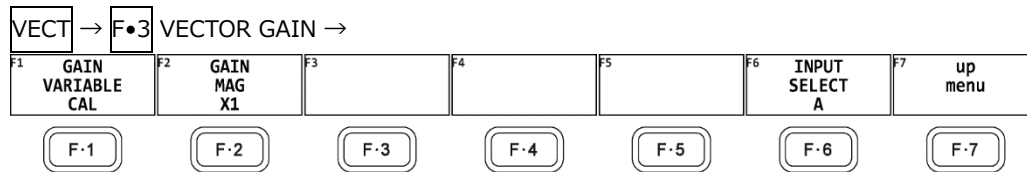

Figure 11-12 VECTOR GAIN menu

11.6.1 Setting the Variable Gain

To set the variable vector gain, follow the procedure below.

Procedure



Settings

CAL:	The waveform gain is fixed.
VARIABLE:	<p>You can adjust the waveform gain by turning the function dial (F•D). Press the function dial (F•D) to return the setting to its default value. The adjusted gain value (the combination of F•1 GAIN VARIABLE and F•2 GAIN MAG) appears in the lower right of the screen.</p> <p>0.200 - <u>1.000</u> - 2.000 (for X1)</p> <p>1.000 - <u>5.000</u> - 10.000 (for X5)</p> <p>0.620 - <u>3.120</u> - 6.240 (for IQ-MAG, not SD, and component display)</p> <p>0.580 - <u>2.920</u> - 5.840 (for IQ-MAG, SD, and composite display)</p> <p>0.570 - <u>2.850</u> - 5.700 (for IQ-MAG, not SD, and pseudo-composite display)</p> <p>0.520 - <u>2.630</u> - 5.260 (for IQ-MAG, SD, and pseudo-composite display)</p>

11. VECTOR DISPLAY

11.6.2 Selecting the Fixed Gain

To select the fixed vector gain, follow the procedure below.

Procedure

VECT	→	F•3	VECTOR GAIN	→	F•2	GAIN MAG: <u>X1</u> / X5 / IQ-MAG
------	---	-----	-------------	---	-----	-----------------------------------

Settings

X1: Vectors are displayed at ×1 magnification.

X5: Vectors are displayed at ×5 magnification.

IQ-MAG: Vectors are displayed using the following magnifications.

×3.12 (for not SD, and component display; magnification that causes the I signal of the multiformat color bar to lie on the circumference of the scale)

×2.85 (for not SD, and pseudo-composite display; magnification that causes the I signal of the multiformat color bar, which has gone through pseudo-composite conversion, to lie on the circumference of the scale)

×2.92 (for SD, and component display; magnification that causes the amplitude to lie on the circumference of the scale when the burst signal of the composite vector display is converted into component signals)

×2.63 (for SD, and pseudo-composite display; magnification that causes the -I and Q signals of the SMPTE color bar, which has gone through pseudo-composite conversion, to lie on the circumference of the scale)

When the variable scale is set to on, you cannot select this setting.

11.6.3 Turning the Guide Display On and Off

When the variable scale is set to on and the fixed vector gain is set to X5, to turn the guide display on and off. When set to on, the current display position is displayed in the upper right of the screen.

Procedure

VECT	→	F•3	VECTOR GAIN	→	F•3	GUIDE DISPLAY: ON / <u>OFF</u>
------	---	-----	-------------	---	-----	--------------------------------

11.7 Setting the RGB Vector Gain

When the SER40 is installed and the vector mode is set to RGB VECTOR, you can set the gain, use **F•3** RGB VECTOR GAIN on the VECT menu.

To set the gain, press **F•3** RGB VECTOR GAIN on the VECT menu.

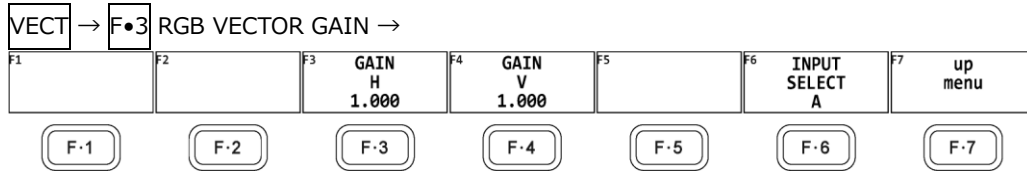
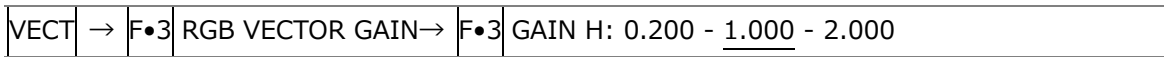

Figure 11-13 RGB VECTOR GAIN menu

11.7.1 Adjusting the Gain H

To adjust the gain H, follow the procedure below.

Procedure



11.7.2 Adjusting the Gain V

To adjust the gain V, follow the procedure below.

Procedure

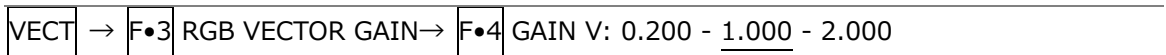

11.8 Setting the YCbCr Vector Gain

When the SER40 is installed and the vector mode is set to YCbCr VECTOR, you can set the gain, use **F•3** YCbCr VECTOR GAIN on the VECT menu.

To set the gain, press **F•3** VECTOR GAIN on the VECT menu.

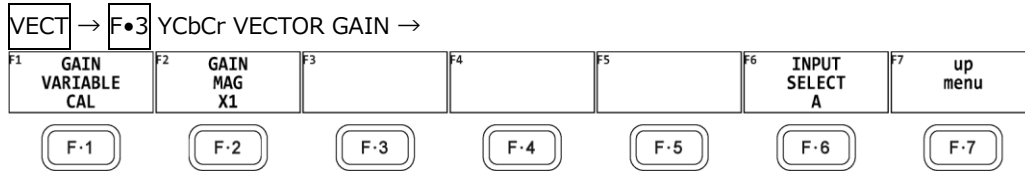

Figure 11-14 YCbCr VECTOR GAIN menu

11.8.1 Setting the Variable Gain

To set the variable vector gain, see section 11.6.1, "Setting the Variable Gain."

11.8.2 Selecting the Fixed Gain

To select the fixed vector gain, see section 11.6.2, "Selecting the Fixed Gain." However, IQ-MAG cannot be selected.

11.8.3 Selecting the Observation Point

When the fixed vector gain is set to X5, to select the observation point, follow the procedure below.

Procedure

VECT → **F•3** YCbCr VECTOR GAIN → **F•3** OBSERVATION POINT: B-Y:Wh / B-Y:Yl / B-Y:Cy / B-Y:G / B-Y:TIMING / B-Y:Mg / B-Y:R / B-Y:B / BI / R-Y:B / R-YR / R-Y:Mg / R-Y:TIMING / R-Y:G / R-Y:Cy / R-Y:Yl / R-Y:Wh

11.9 Configuring the Marker Settings

To configure the marker settings, press **F•4** MARKER or **F•4** VARIABLE MARKER.

When the VARIABLE SCALE is set to off, you can use **F•4** MARKER to turn the marker display on and off.

When the VARIABLE SCALE is set to on, you can use **F•4** VARIABLE MARKER to display the VARIABLE MARKER menu.

[See also] VARIABLE SCALE → 11.3.7, "Turning the Variable Scale On and Off"

11.9.1 Displaying the Vector Marker

When the VARIABLE SCALE is set to off, to display a marker on the vector display, follow the procedure below.

[See also] VARIABLE SCALE → 11.3.7, "Turning the Variable Scale On and Off"

You can move the marker horizontally using the H POS knob and vertically using the V POS knob. The measured values are displayed in the lower left of the display. Press the H POS knob to move the marker to the Cb = 0.0% position. Press the V POS knob to move the marker to the Cr = 0.0% position.

Measured values are displayed using the following references: Cb at position B = 100.0% and Cr at position R = 100.0%. The distance from the center is expressed as "d," and hue is expressed as "deg."

Normally, the marker is displayed in green. When it falls outside the display area, it blinks in red. If this occurs, "OVER" appears above the measured values.

Procedure

VECT → **F•4** MARKER: ON / OFF

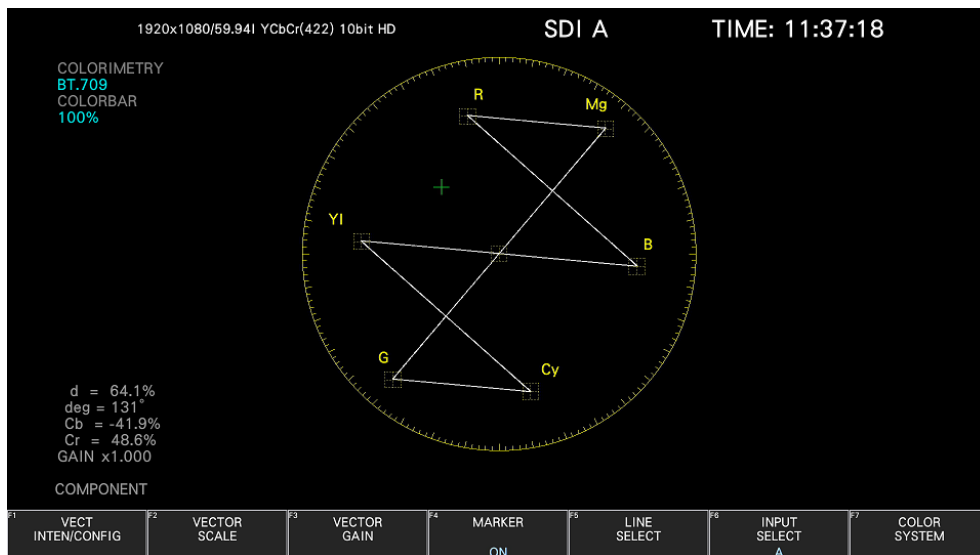

Figure 11-15 Displaying the vector marker

11. VECTOR DISPLAY

11.9.2 Configuring the Variable Marker

When the VARIABLE SCALE is set to on, you can use **F•4** VARIABLE MARKER to configure the variable marker.

[See also] VARIABLE SCALE → 11.3.7, "Turning the Variable Scale On and Off"

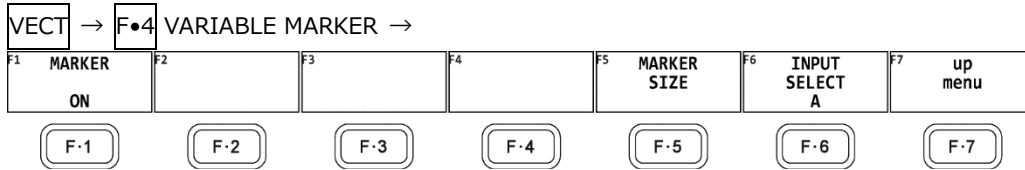

Figure 11-16 VARIABLE MARKER menu

- Turning the Display On and Off

To display the variable marker on the vector display, follow the procedure below.

[See also] VARIABLE SCALE → 11.3.7, "Turning the Variable Scale On and Off"

You can move the marker horizontally using the H POS knob and vertically using the V POS knob. The measured values are displayed in the lower right of the display. Press the H POS knob to move the marker to the Cb = 0.0% position. Press the V POS knob to move the marker to the Cr = 0.0% position.

Measured values are displayed using the following references: Cb at position B = 100.0% and Cr at position R = 100.0%. The distance from the center is expressed as "d," and hue is expressed as "deg."

Procedure

VECT → F•4 VARIABLE MARKER → F•1 MARKER: ON / OFF

- Configuring the Marker Size

To configure the size of the marker and frame, follow the procedure below. It can be configured even if the variable marker is set to off.

Procedure

VECT → F•4 VARIABLE MARKER → F•5 MARKER SIZE: 5 % - 10 %

11. VECTOR DISPLAY

11.10 Configuring the Line Selection Settings

To configure the line selection settings, press **F•5** LINE SELECT on the VECT menu.

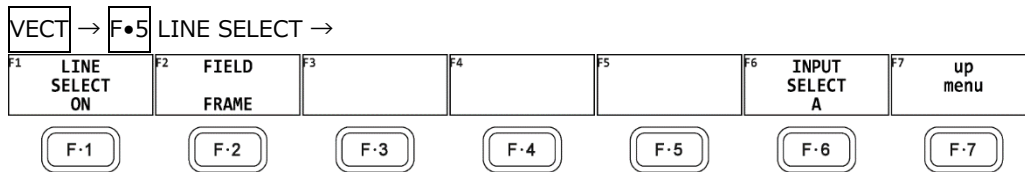

Figure 11-17 LINE SELECT menu

11.10.1 Turning Line Selection On and Off

To display the vector of the selected line, follow the procedure below. You can use the function dial (F•D) to select a line. The number of the selected line appears in the lower left of the screen.

Changing this setting will also change the video-signal-waveform-display and picture-display line selection settings.

This menu item does not appear when SWEEP on the WFM menu is set to V.

[See also] SWEEP → 10.5.1, "Selecting the Sweep Method"

Procedure

VECT → F•5 LINE SELECT → F•1 LINE SELECT: ON / OFF

LINE SELECT = ON

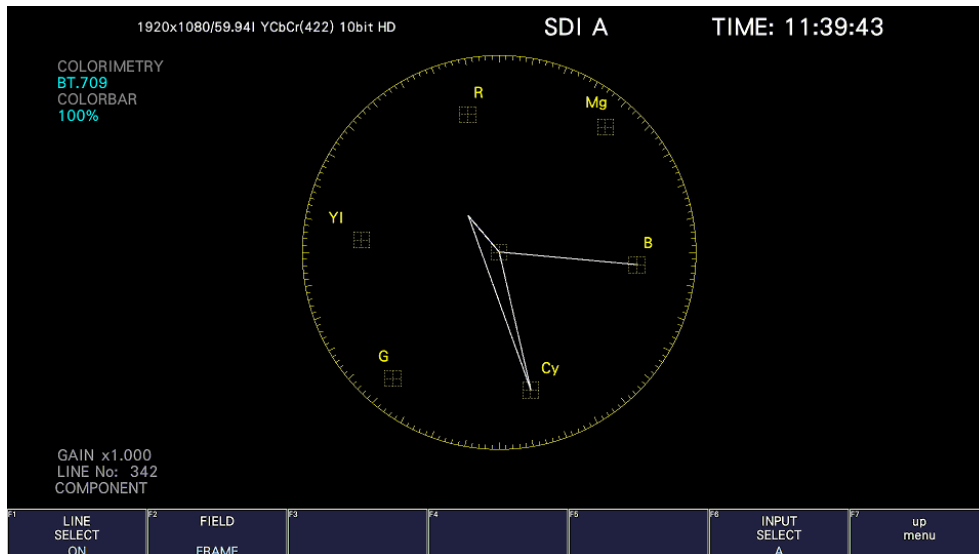

11. VECTOR DISPLAY

LINE SELECT = OFF

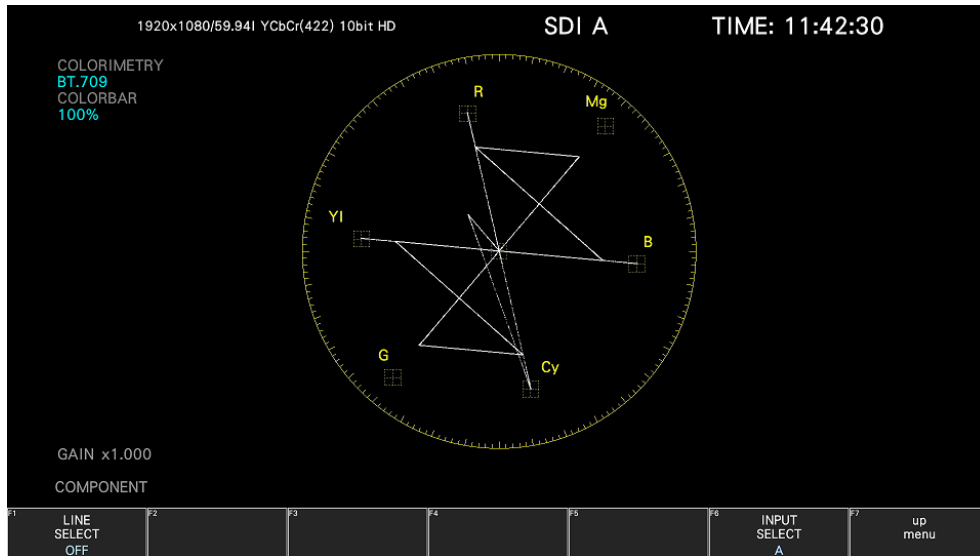

Figure 11-18 Turning line selection on and off

11.10.2 Setting the Line Selection Range

When **F.1** LINE SELECT is set to ON and the input signal format is interlaced or segmented frame, to set the line selection range, follow the procedure below. Changing this setting will also change the selected line on the video-signal-waveform, picture, and status (data dump) displays.

Procedure

VECT	→	F.5	LINE SELECT	→	F.2	FIELD: FIELD1 / FIELD2 / <u>FRAME</u>
------	---	-----	-------------	---	-----	---------------------------------------

Settings

FIELD1:	A line from field 1 can be selected. (Example: 1 to 563)
FIELD2:	A line from field 2 can be selected. (Example: 564 to 1125)
FRAME:	All lines can be selected. (Example: 1 to 1125)

11.11 Configuring the Color System Settings

To configure the color system settings, press **F•7** COLOR SYSTEM on the VECT menu.

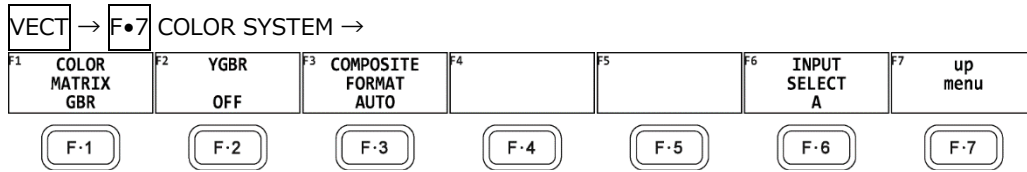

Figure 11-19 COLOR SYSTEM menu

11.11.1 Selecting the Color Matrix

To select the vector display format, follow the procedure below. The selected display format is indicated in the lower right of the display.

Procedure



Settings

- COMPONENT: The component chrominance signal is displayed on the X and Y axes.
- COMPOSITE: The component signal is converted into a pseudo-composite signal, and the pseudo-composite signal's chrominance signal is displayed on the X and Y axes.

COLOR MATRIX = COMPONENT

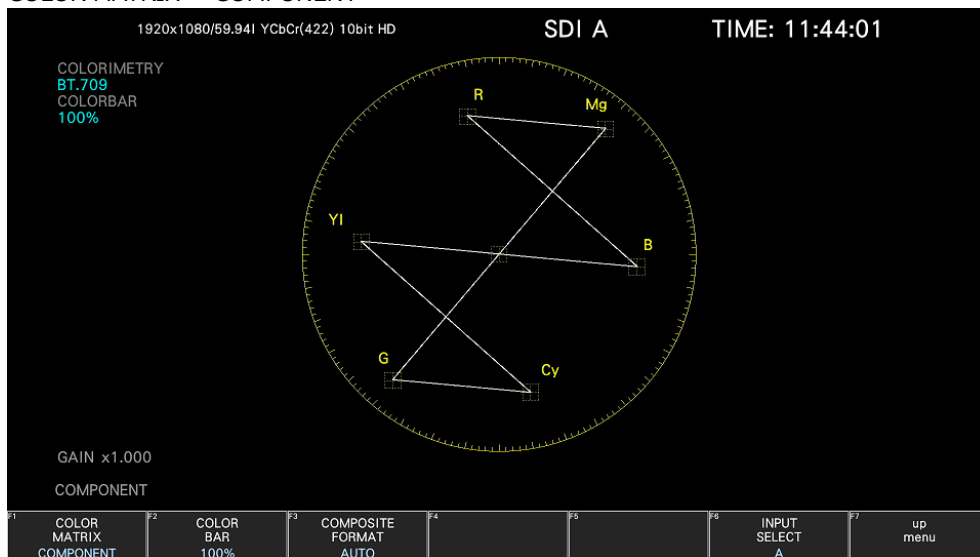

11. VECTOR DISPLAY

COLOR MATRIX = COMPOSITE

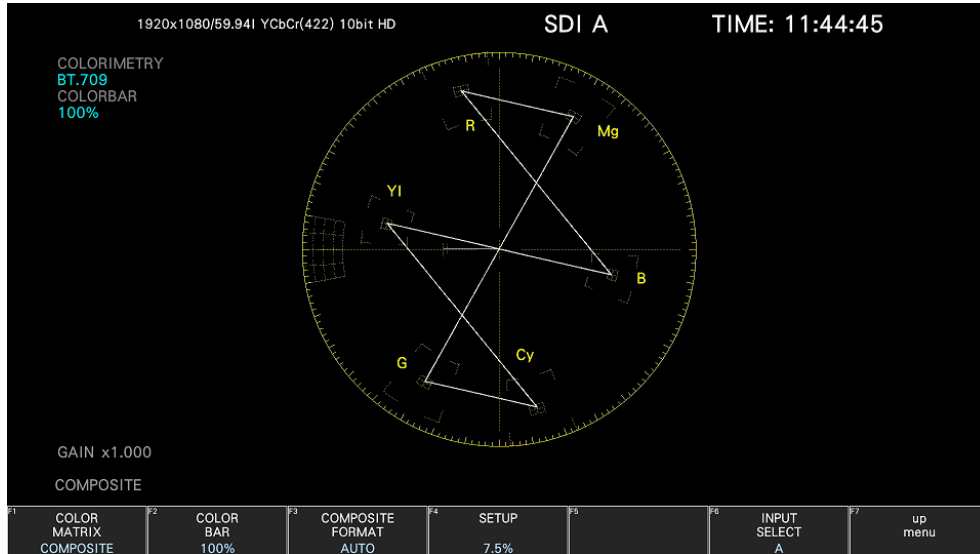

Figure 11-20 Selecting the color matrix

11.11.2 Displaying a Scale for 75% Color Bars

To display a scale for 75 % color bars, follow the procedure below.

The scale selected here is displayed in the COLORBAR on the upper left of the screen.

Procedure

VECT → F•7 COLOR SYSTEM → F•2 COLOR BAR: 100% / 75%

Settings

100%: A scale on which a 100% color bar signal input is mapped to the peak level is displayed.

75%: A scale on which a 75% color bar signal input is mapped to the peak level is displayed.

COLOR BAR = 75%

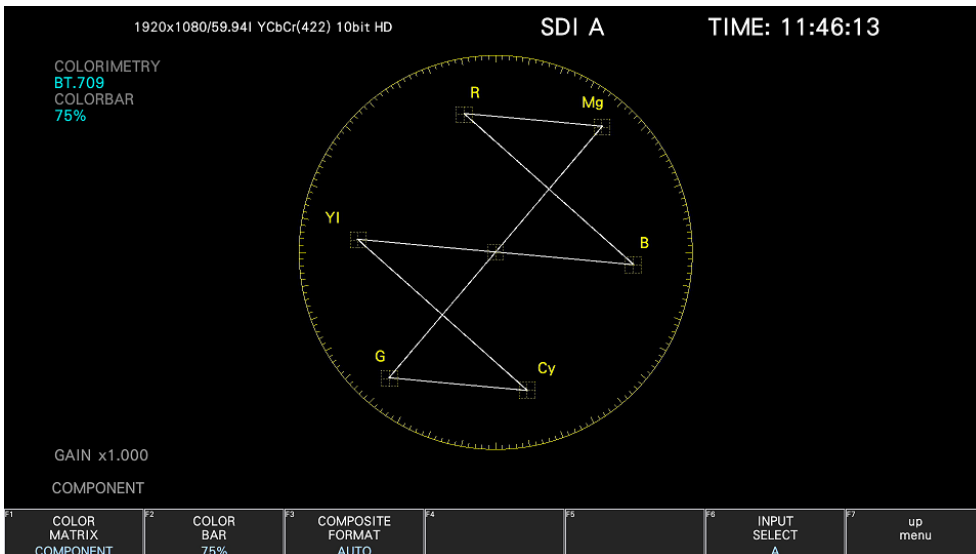

Figure 11-21 Displaying a scale for 75 % color bars (when receiving a 75 % intensity color bar signal)

11. VECTOR DISPLAY

11.11.3 Selecting the Composite Display Format

To select the composite display format, follow the procedure below.

Procedure

VECT	→	F•7	COLOR SYSTEM →	F•3	COMPOSITE FORMAT: <u>AUTO</u> / NTSC / PAL
------	---	-----	----------------	-----	--

Settings

AUTO:	When the input signal frame rate is 25 Hz or 50 Hz, the format is PAL. Otherwise, the format is NTSC.
NTSC:	The format is NTSC.
PAL:	The format is PAL.

COMPOSITE FORMAT = NTSC

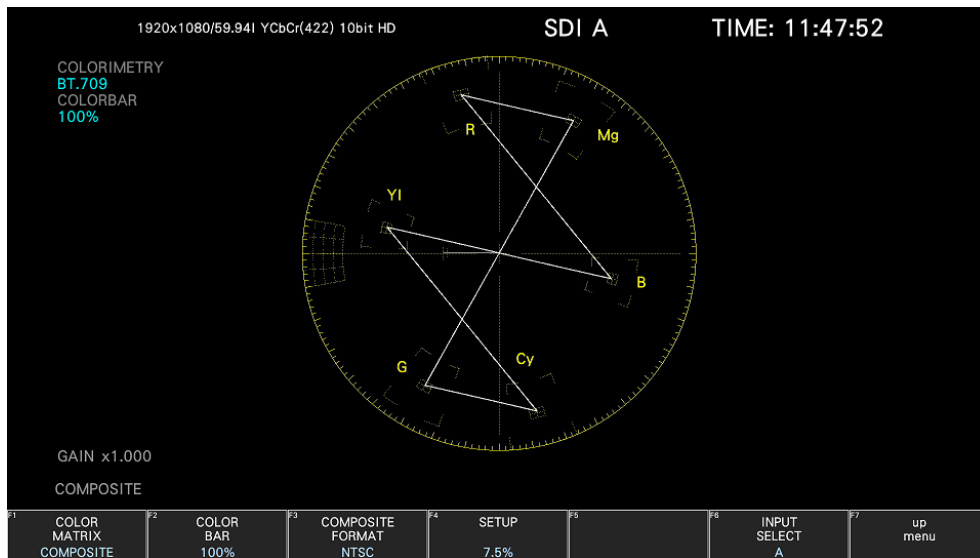

COMPOSITE FORMAT = PAL

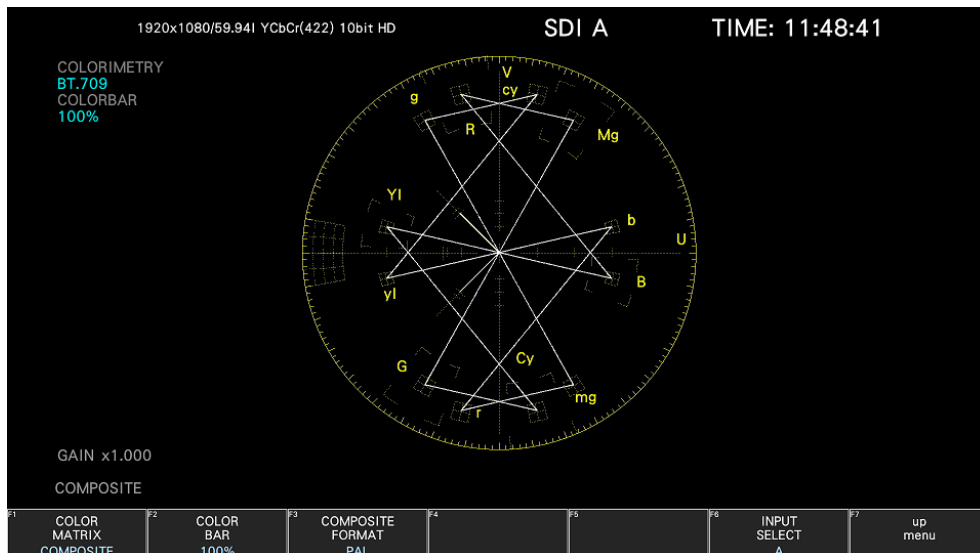

Figure 11-22 Selecting the composite display format

11. VECTOR DISPLAY

11.11.4 Selecting the Setup Level

When **F•1** COLOR MATRIX is set to COMPOSITE, to select the setup level, follow the procedure below.

This menu does not appear if the composite display format is PAL.

Procedure

VECT	→	F•7	COLOR SYSTEM	→	F•4	SETUP: <u>0%</u> / 7.5%
------	---	-----	--------------	---	-----	-------------------------

11. VECTOR DISPLAY

11.12 5-Bar Display

To display the 5 bar screen, press VECT, **F•1** VECT INTEN/CONFIG, and then **F•1** VECTOR DISPLAY to select 5BAR.

In the 5-bar display, the $YCbCr$ signal is converted into a GBR or pseudo-composite signal, and the peak levels of the converted signal's Y, G, B, R, and CMP (composite) components are displayed simultaneously using five bars.

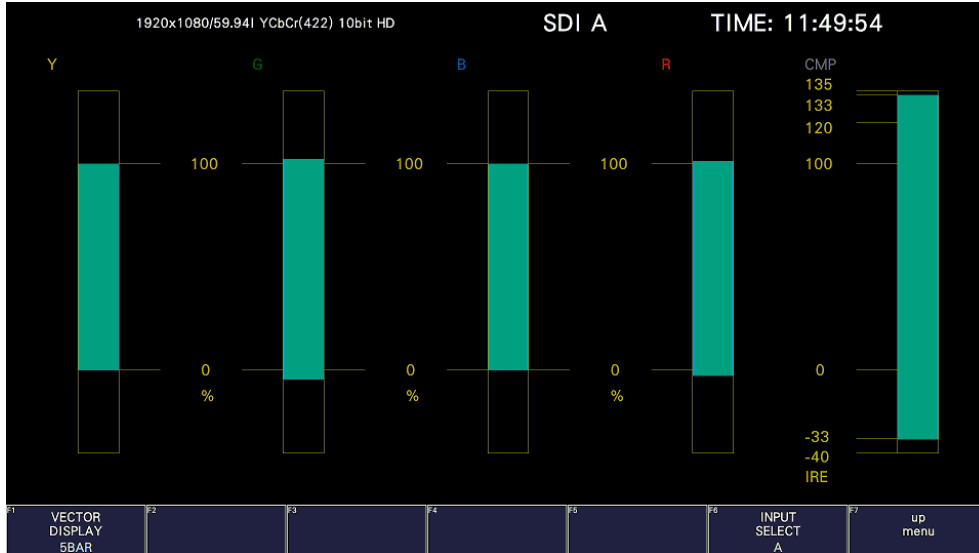

Figure 11-23 5-bar display

- Y
Levels that fall outside of the range that you set using Luminance Upper and Luminance Lower on the status menu are displayed in red.
[See also] Luminance Upper and Luminance Lower → 4, "Error Setup 4"
- GBR
Levels that fall outside of the range that you set using Gamut Upper and Gamut Lower on the status menu are displayed in red.
[See also] Gamut Upper/Lower → 16.2.3, "Error Setup 3"
- CMP
Levels that fall outside of the range that you set using Composite Upper and Composite Lower on the status menu are displayed in red.
[See also] Composite Upper/Lower → 16.2.3, "Error Setup 3"
- Menu
Use the VECT menu to configure the 5-bar display settings.

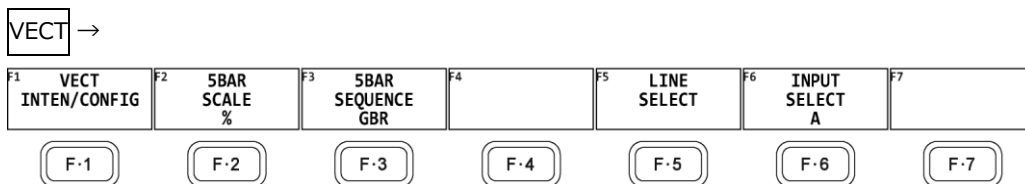

Figure 11-24 Vector menu

11. VECTOR DISPLAY

11.12.1 Selecting the Scale Unit

When VECTOR DISPLAY is set to 5BAR, to select the scale unit, follow the procedure below.
 [See also] VECTOR DISPLAY → 11.2.1, "Switching the Display Mode" and 11.11.3, "Selecting the Composite Display Format"

Procedure

VECT	→	F•2	5BAR SCALE: % / mV / HEX / DEC
------	---	-----	--------------------------------

Settings

%:	The display unit for YGBR is percentage, and the display unit for CMP is IRE.
mV:	The display unit is mV. Depending on the composite display format, the scale differs as follows: NTSC: 100 % = 700 mV (YGBR), 100IRE = 714.3 mV (CMP) PAL: 100% (IRE) = 700mV
HEX:	YGBR is displayed as a percentage with 0 to 100% expressed as 040 to 3AC. CMP is displayed using IRE.
DEC:	YGBR is displayed as a percentage with 0 to 100% expressed as 64 to 940. CMP is displayed using IRE.

5BAR SCALE = %

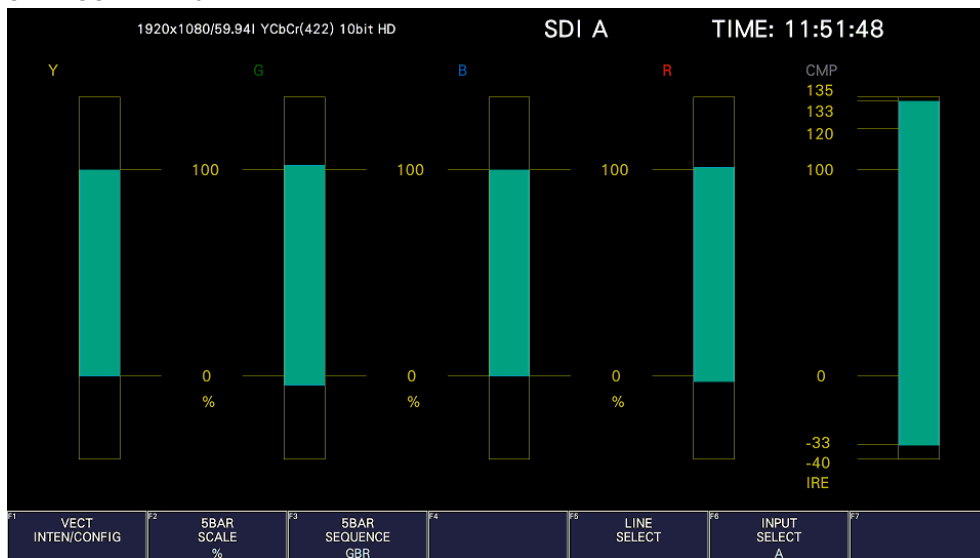

11. VECTOR DISPLAY

5BAR SCALE = mV

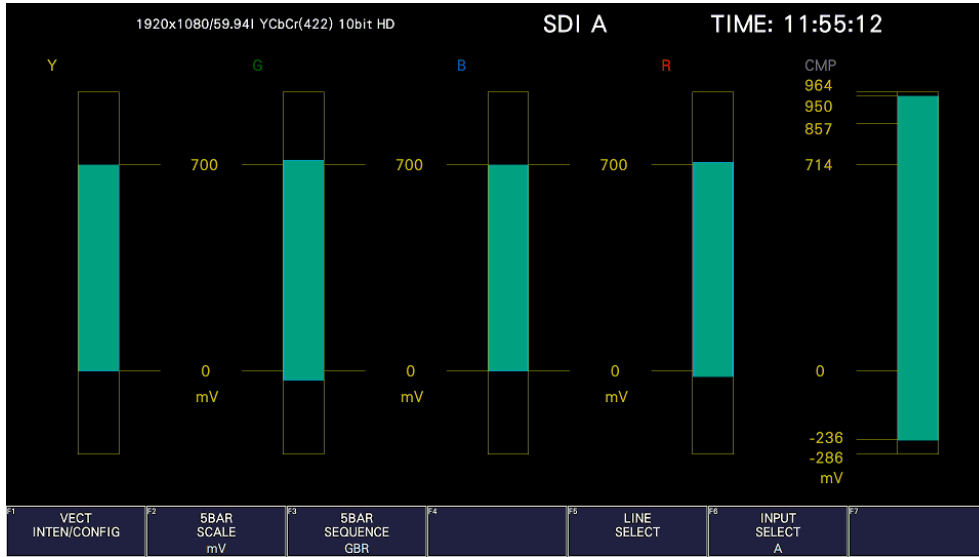

5BAR SCALE = HEX

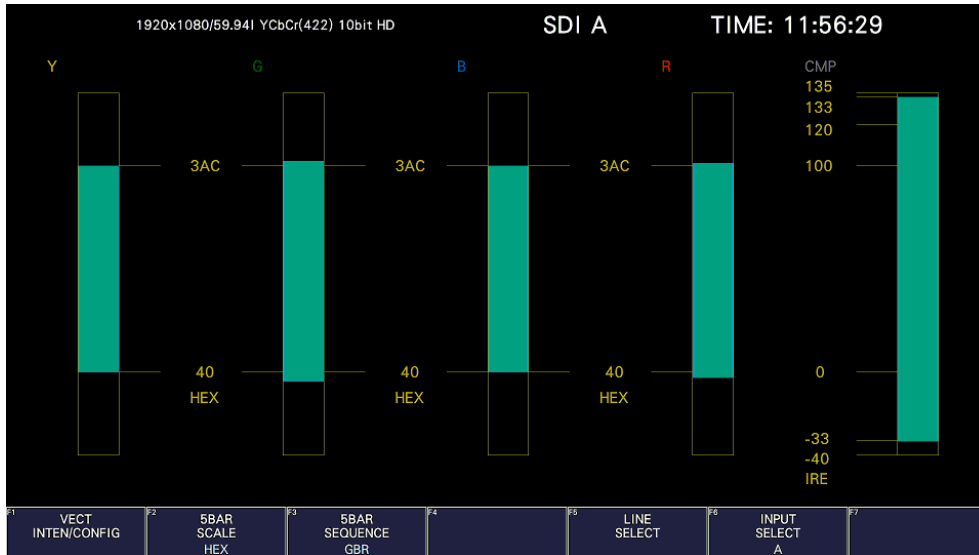

5BAR SCALE = DEC

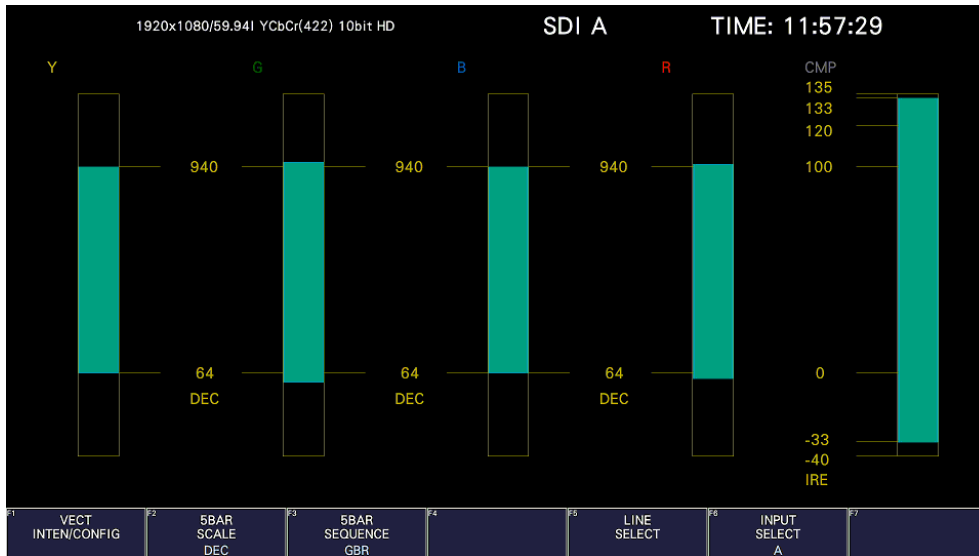

Figure 11-25 Selecting the scale unit

11. VECTOR DISPLAY

11.12.2 Selecting the Display Order

To select the 5-bar display order, follow the procedure shown below.

Procedure

VECT	→	F•3	5BAR SEQUENCE: <u>GBR</u> / RGB
------	---	-----	---------------------------------

Settings

GBR: From the left, the signals are displayed in this order: Y, G, B, R, CMP.

RGB: From the left, the signals are displayed in this order: Y, R, G, B, CMP.

5BAR SEQUENCE = GBR

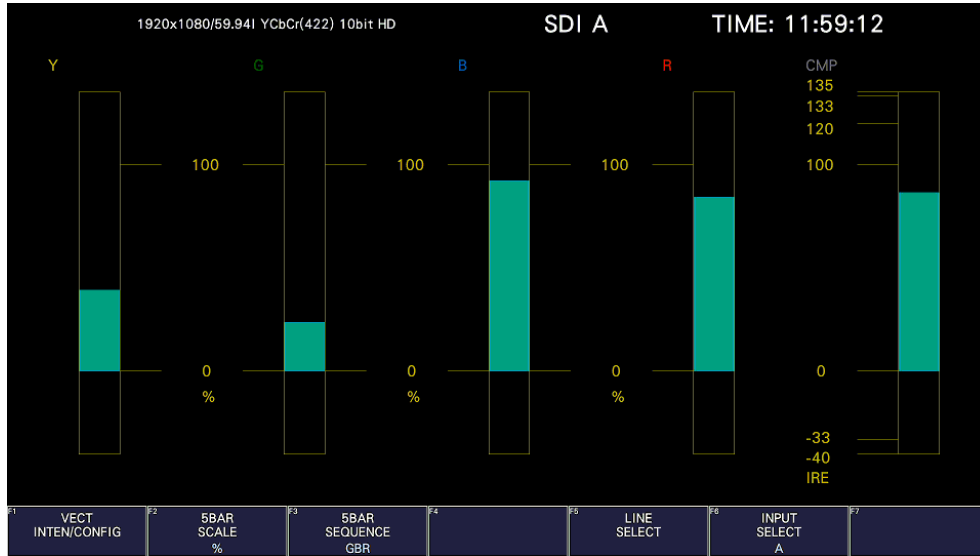

5BAR SEQUENCE = RGB

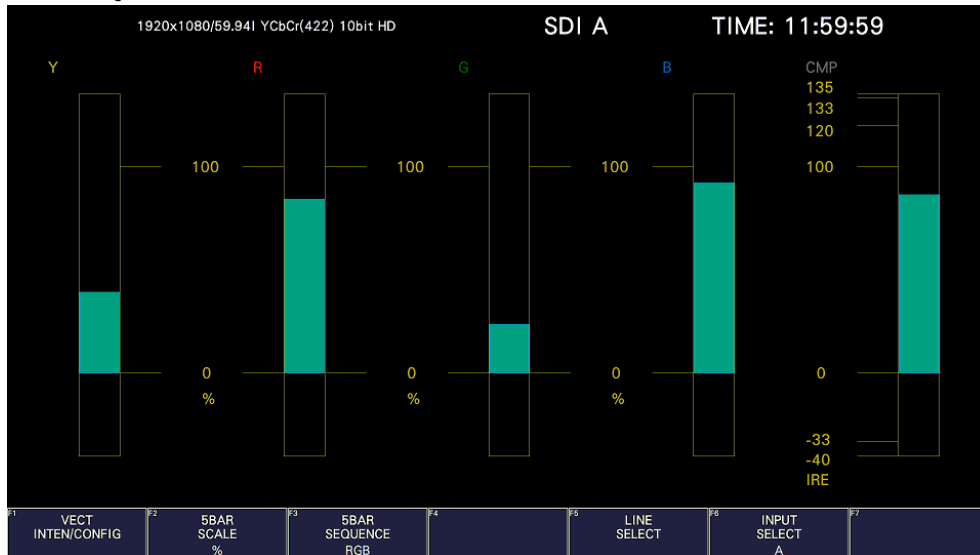

Figure 11-26 Selecting the display order

11.13 Histogram Display

To display histograms, press VECT, **F•1** VECT INTEN/CONFIG, and then **F•1** VECTOR DISPLAY to select HISTOGRAM.

The histogram display shows the image data distribution by plotting the luminance level and R, G, B levels on the horizontal axis and the number of pixels at each luminance level and R, G, B level on the vertical axis.

If SER23 is installed, you can change the horizontal scale. See section 14.2.2, "Histogram Display."

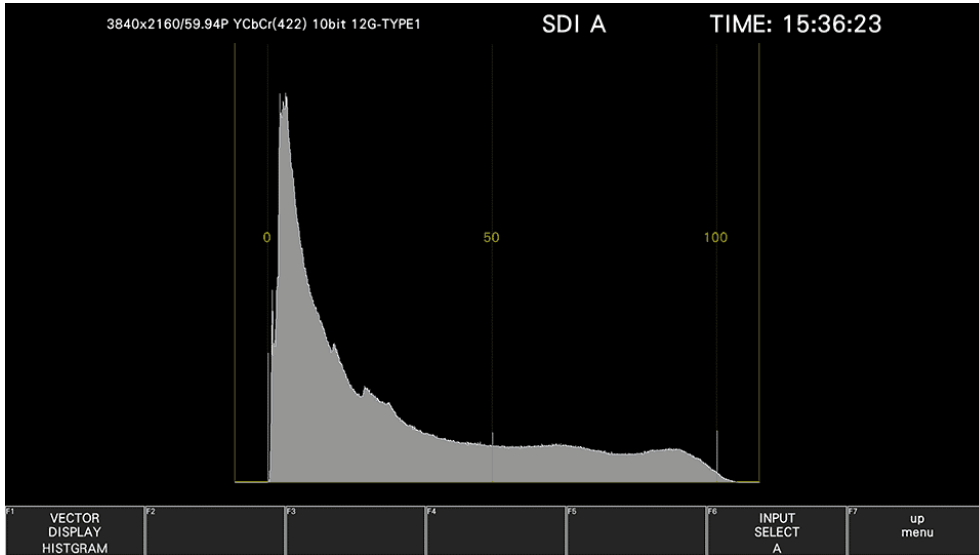

Figure 11-27 Histogram Display

• Menu

Use the VECT menu to configure the histogram display settings.

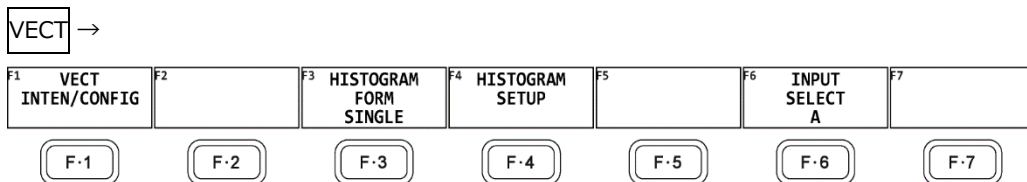

Figure 11-28 Vector menu

11.13.1 Selecting the Display Format

To select the display format, follow the procedure below.

Procedure

VECT → **F•3** HISTOGRAM FORM: SINGLE / TILE / ALIGN_H / ALIGN_V

Settings

- SINGLE: Luminance, R, G, or B is displayed.
- TILE: Luminance, R, G, and B are displayed in tiles.
- ALIGN_H: Luminance, R, G, and B are displayed side by side.
- ALIGN_V: Luminance, R, G, and B are displayed top to bottom.

11. VECTOR DISPLAY

- When HISTOGRAM FORM is TILE

Luminance, R, G, and B are displayed in tiles.

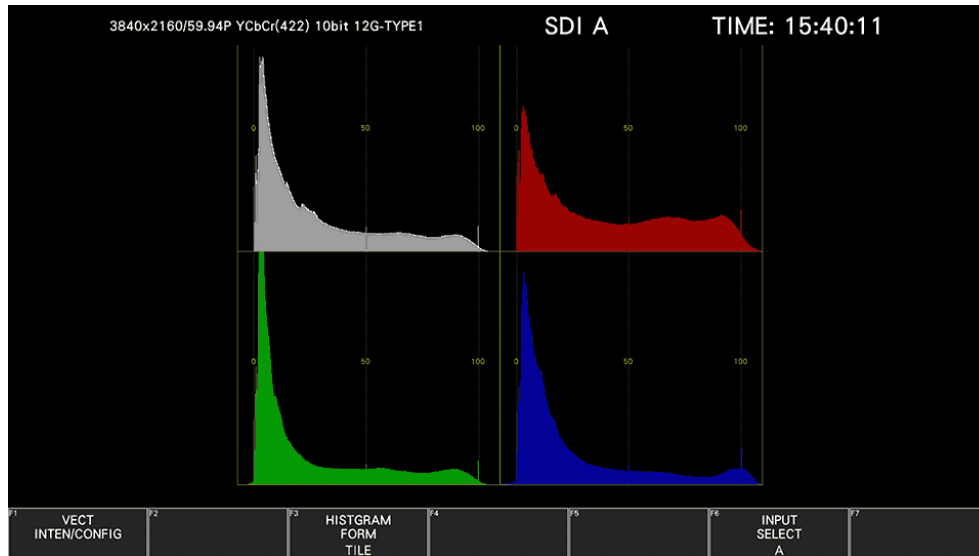

Figure 11-29 Tiled display

- When HISTOGRAM FORM is ALIGN-H

Luminance, R, G, and B are displayed side by side.

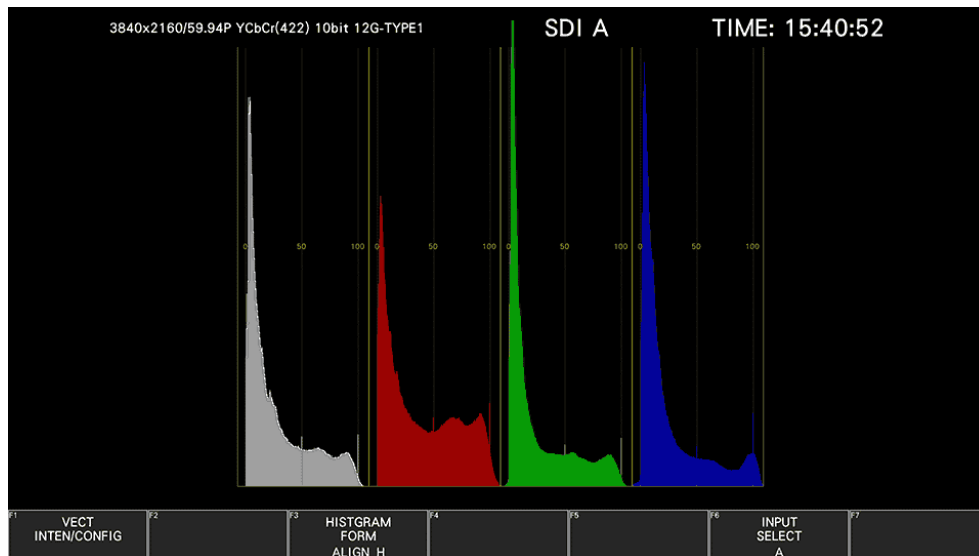

Figure 11-30 ALIGN_H display

11. VECTOR DISPLAY

- When HISTOGRAM FORM is ALIGN-V

Luminance, R, G, and B are displayed top to bottom.

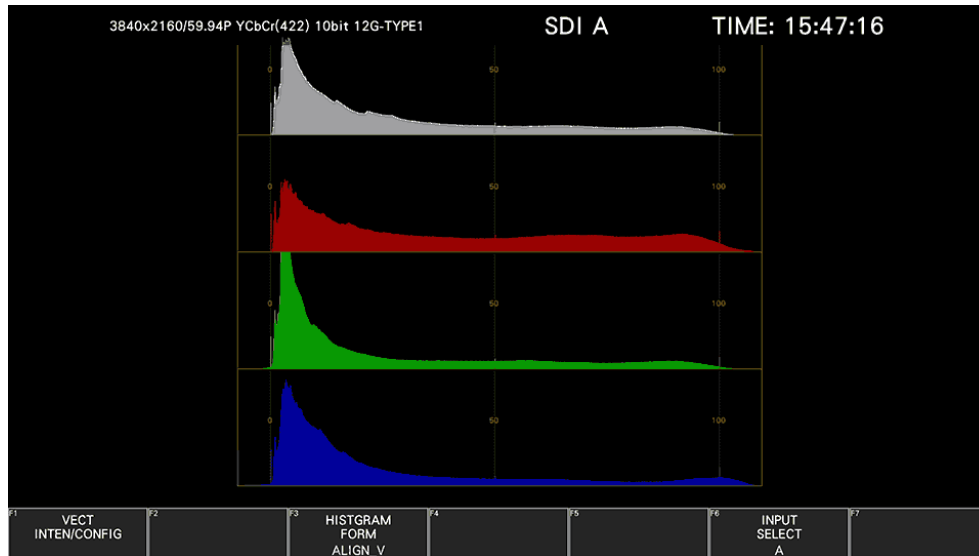

Figure 11-31 ALIGN_V display

11.13.2 Selecting the Measurement Signal

When HISTOGRAM FORM is SINGLE, to select the measurement signal, follow the procedure below. A single signal from luminance, R, G, and B can be turned on.

Procedure

VECT	→	F•4	HISTOGRAM SETUP
→	F•1	Y: ON / OFF	
→	F•2	R: ON / OFF	
→	F•3	G: ON / OFF	
→	F•4	B: ON / OFF	

12. CIE CHROMATICITY DIAGRAM DISPLAY

To display the CIE chromaticity diagram, press VECT, **F•1** VECT INTEN/CONFIG, and then **F•1** VECTOR DISPLAY to select CIE DIAGRAM.

When VECTOR DISPLAY is set to VECT, 5BAR or HISTOGRAM, see 11, "CIE Chromaticity Diagram Display," for the explanation.

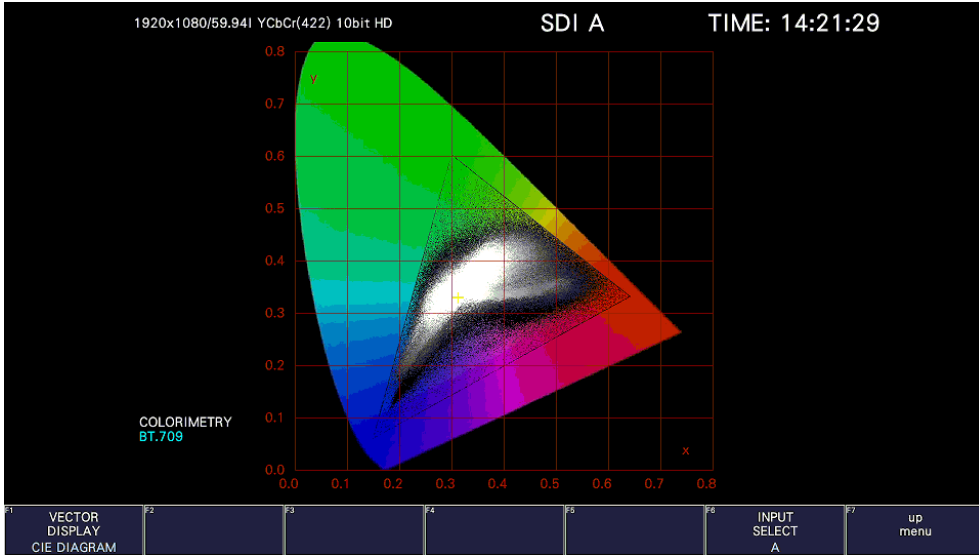

Figure 12-1 CIE chromaticity diagram display

- Colorimetry

The colorimetry selected on the SYS menu is displayed in cyan in the lower left of the screen. However, for 3G(DL)-4K and 3G(QL), the current applied colorimetry is displayed in yellow if the colorimetry information of all links specified by the payload ID are not matched.

12.1 Setting the Scale

To configure the scale, use **F•2** CIE DIAGRAM SCALE on the VECT menu.

This menu item does not appear when DISPLAY MODE is set to TEMP.

[See also] DISPLAY MODE → 12.2.1, "Selecting the Display Mode"

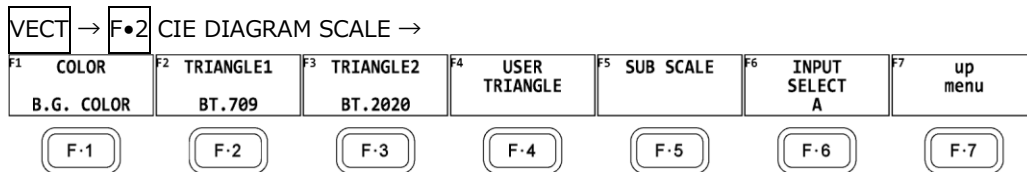

Figure 12-2 CIE DIAGRAM SCALE menu

12. CIE CHROMATICITY DIAGRAM DISPLAY

12.1.1 Selecting the Color Scale

To select the horseshoe-shaped color scale, follow the procedure below.

Procedure

VECT	→	F•2	CIE DIAGRAM SCALE	→	F•1	COLOR: <u>B.G. COLOR</u> / B.G. WHITE / B.G. BLACK
------	---	-----	-------------------	---	-----	--

Settings

B.G. COLOR: The color scale is displayed. The background is black, and the waveform is displayed according to the luminance level.

B.G. WHITE: The color scale is not displayed. The background is white, and the waveform is displayed according to the picture color.

B.G. BLACK: The color scale is not displayed. The background is black, and the waveform is displayed according to the picture color.

COLOR = B.G. WHITE

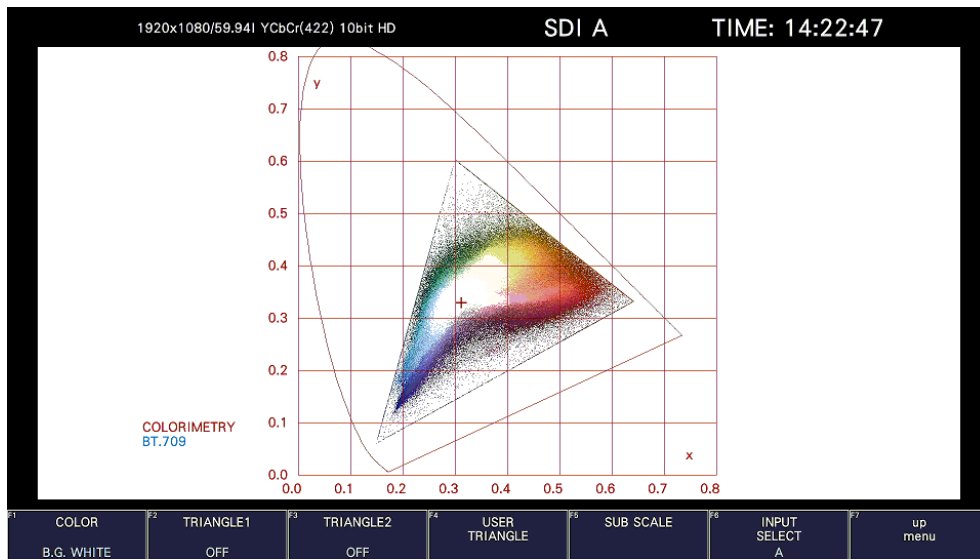

COLOR = B.G. BLACK

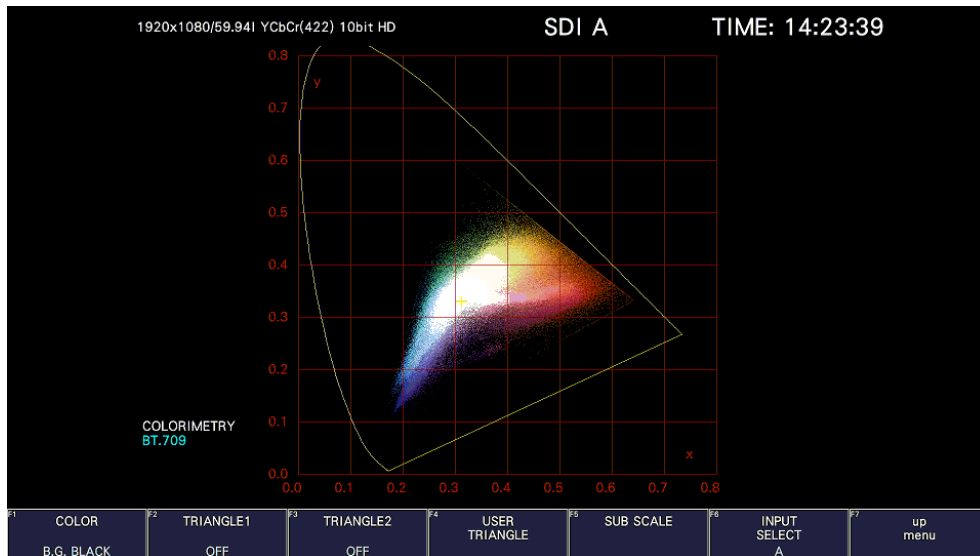

Figure 12-3 Selecting the color scale

12. CIE CHROMATICITY DIAGRAM DISPLAY

12.1.2 Selecting the Triangle

To display up to three color triangles, follow the procedure below.

Procedure

VECT → F•2 CIE DIAGRAM SCALE
 → F•2 TRIANGLE1: BT.601(525) / BT.601(625) / BT.709 / DCI / BT.2020 / OFF
 → F•3 TRIANGLE2: BT.601(525) / BT.601(625) / BT.709 / DCI / BT.2020 / OFF
 → F•4 USER TRIANGLE → F•1 TRIANGLE: 1 / 2 / OFF

The color triangle vertex coordinates are shown below.

$u'v'$ coordinates are calculated from the xy coordinates.

Table 12-1 Color triangle vertex coordinates

F•1 TRIANGLE1	F•2 TRIANGLE2	CIE1931		CIE1976	
		x	y	u'	v'
BT.601(525)	R	0.630	0.340	0.433	0.526
	G	0.310	0.595	0.130	0.563
	B	0.155	0.070	0.176	0.178
BT.601(625)	R	0.640	0.330	0.451	0.523
	G	0.290	0.600	0.121	0.561
	B	0.150	0.060	0.175	0.158
BT.709	R	0.640	0.330	0.451	0.523
	G	0.300	0.600	0.125	0.563
	B	0.150	0.060	0.175	0.158
DCI	R	0.680	0.320	0.496	0.526
	G	0.265	0.690	0.099	0.578
	B	0.150	0.060	0.175	0.158
BT.2020	R	0.708	0.292	0.557	0.517
	G	0.170	0.797	0.056	0.587
	B	0.131	0.046	0.159	0.126

12. CIE CHROMATICITY DIAGRAM DISPLAY

12.1.3 Setting the User-defined Triangle

To set the user-defined triangle, press **F•4** USER TRIANGLE on the CIE DIAGRAM SCALE menu.

Up to two user-defined triangles can be specified. Press **F•1** TRIANGLE to select 1 or 2.

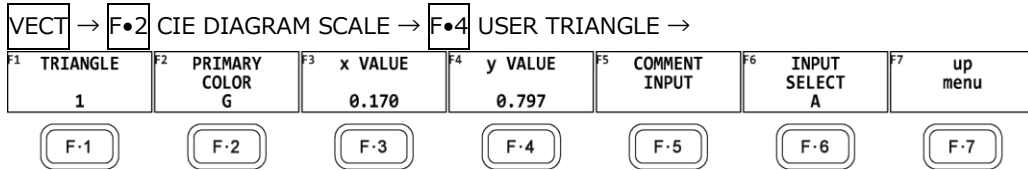
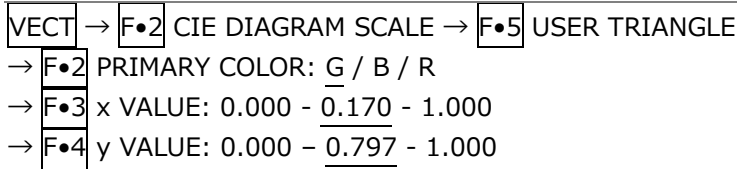

Figure 12-4 USER TRIANGLE menu

To change the vertex coordinates of the color triangle, follow the procedure below. Press **F•2** PRIMARY COLOR to select the vertex you want to change, and then press **F•3** x VALUE and **F•4** y VALUE to set the coordinates. The default setting is equivalent to the BT.2020 coordinates.

Procedure



Press **F•5** COMMENT INPUT to assign names of your choice to user-defined triangles. Enter up to 8 characters.

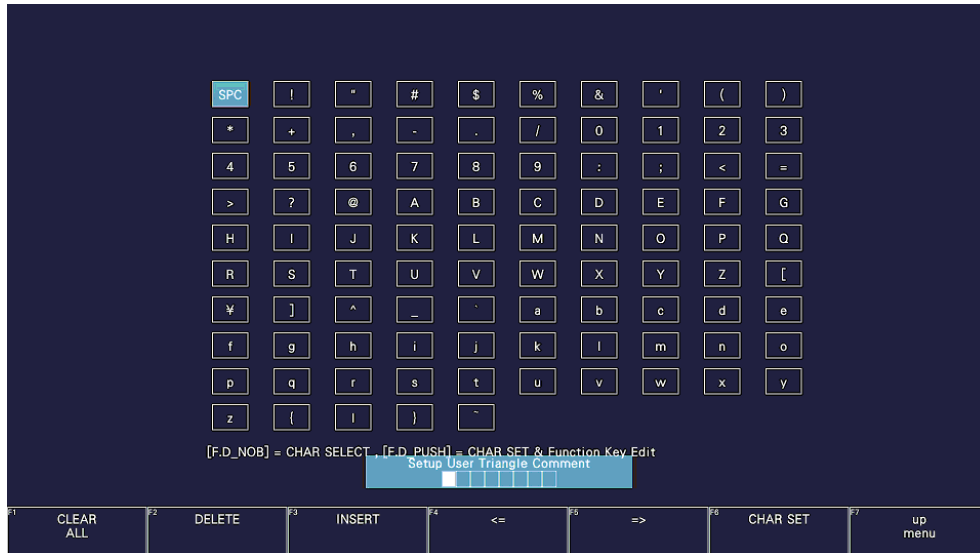

Figure 12-5 Triangle name input screen

12. CIE CHROMATICITY DIAGRAM DISPLAY

The key operations that you can perform in the triangle name input display are as follows:

F•1	CLEAR ALL	Deletes all characters
F•2	DELETE	Deletes the character at the cursor
F•3	INSERT	Inserts a character at the cursor
F•4	<=	Moves the cursor to the left
F•5	=>	Moves the cursor to the right
F•6	CHAR SET	Enters the character
Function dial (F•D)		Turn to select a character, and press to enter the character.

12. CIE CHROMATICITY DIAGRAM DISPLAY

12.1.4 Turning the Sub Scale On and Off

To set the sub scale, press **F•5** SUB SCALE on the CIE DIAGRAM SCALE menu.

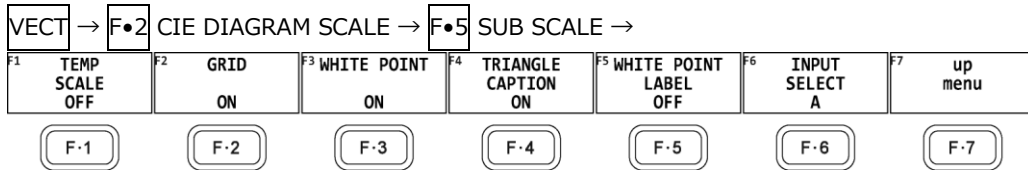
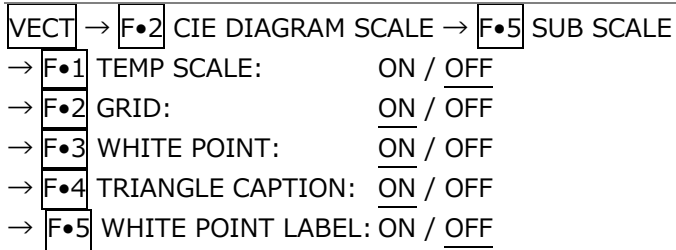

Figure 12-6 SUB SCALE menu

To turn on and off the color temperature curve, grid, white point, triangle name, or white point label, follow the procedure below.

When **F•3** WHITE POINT is on, **F•5** WHITE POINT LABEL is displayed. The white point label is set to DCI W when the colorimetry is set to DCI. Otherwise, it is set to D65.

Procedure



TEMP SCALE = ON / GRID = ON / WHITE POINT = ON / TRIANGLE CAPTION = ON / WHITE POINT LABEL = OFF

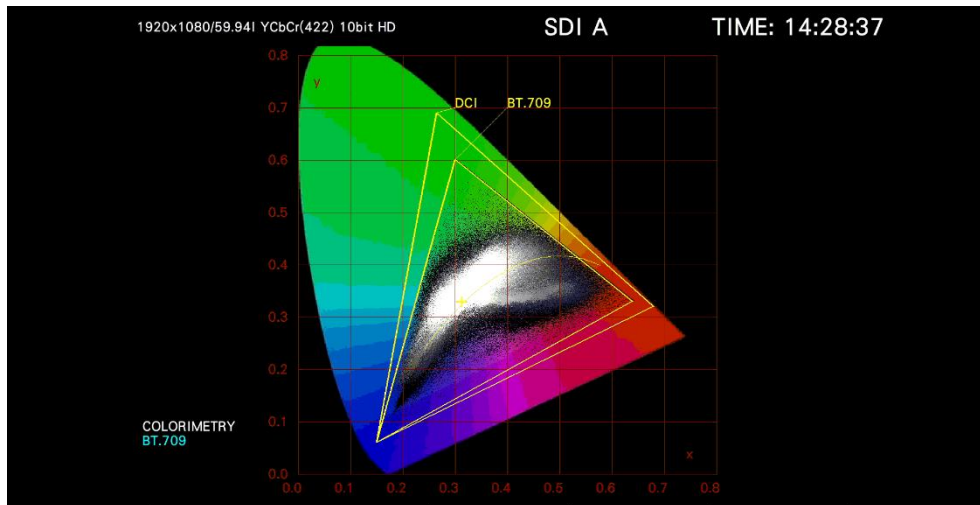

Figure 12-7 The sub scale display

12. CIE CHROMATICITY DIAGRAM DISPLAY

12.2 Setting the Chromaticity Diagram Mode

To set the chromaticity diagram mode, press **F•3** CIE DIAGRAM SETTING on the VECT menu.

VECT → **F•3** CIE DIAGRAM SETTING →

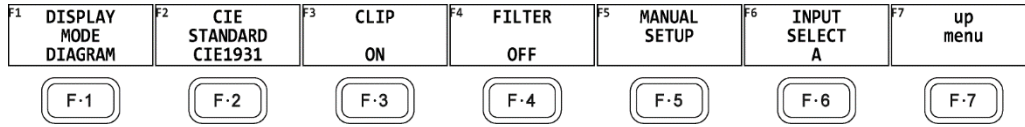

Figure 12-8 CIE DIAGRAM SETTING menu

12.2.1 Selecting the Display Mode

To select the display mode, follow the procedure below.

Procedure

VECT → **F•3** CIE DIAGRAM SETTING → **F•1** DISPLAY MODE: DIAGRAM / TEMP

Settings

DIAGRAM: The chromaticity diagram is displayed.

TEMP: The color temperature is displayed.

DISPLAY MODE = TEMP

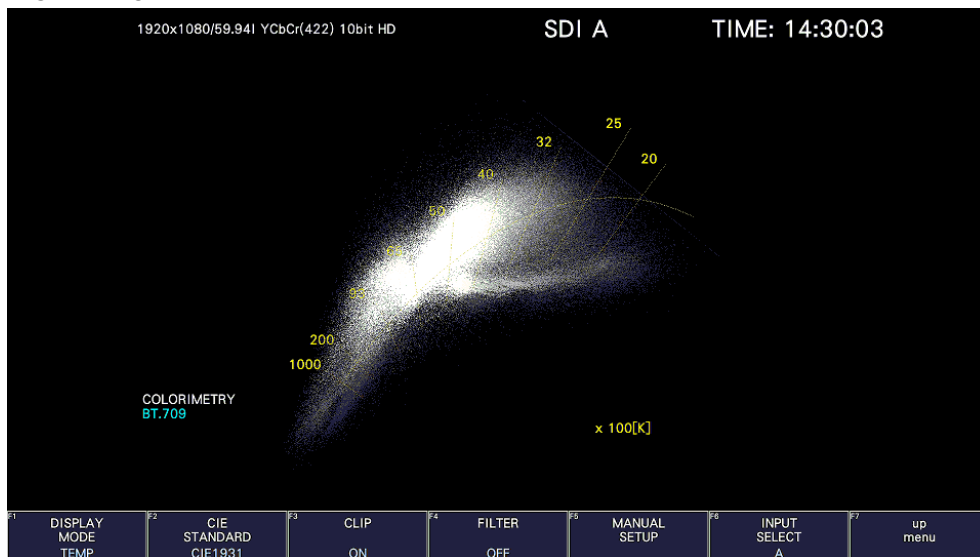

Figure 12-9 Selecting the display mode

12.2.2 Selecting the Display Standard

To select the display standard, follow the procedure below.

Procedure

VECT → **F•3** CIE DIAGRAM SETTING → **F•2** CIE STANDARD: CIE1931 / CIE1976

Settings

CIE1931: Chromaticity diagram based on CIE 1931 is displayed.

CIE1976: Chromaticity diagram based on CIE 1976 is displayed.

12. CIE CHROMATICITY DIAGRAM DISPLAY

12.2.3 Turning Clipping On and Off

To turn clipping on and off, follow the procedure below.

Procedure

VECT	→	F•3	CIE DIAGRAM SETTING	→	F•3	CLIP: <u>ON</u> / OFF
------	---	-----	---------------------	---	-----	-----------------------

Settings

ON: Negative values of the input signal are clipped to zero.

OFF: Negative values of the input signal are displayed according to BT.1361.

12.2.4 Turning the Filter On and Off

To turn the filter on and off, follow the procedure below.

When set to ON, data is averaged every two pixels and displayed.

Procedure

VECT	→	F•3	CIE DIAGRAM SETTING	→	F•4	FILTER: ON / <u>OFF</u>
------	---	-----	---------------------	---	-----	-------------------------

12.2.5 Setting the Gamma Value

To set the gamma value, follow the procedure below.

Procedure

VECT	→	F•3	CIE DIAGRAM SETTING	→	F•5	MANUAL SETUP
	→	F•1	MANUAL SETUP: ON / <u>OFF</u>			
	→	F•2	COLORIMETRY: BT.601(525) / BT.601(625) / <u>BT.709</u> / DCI / BT.2020			
	→	F•5	GAMMA SETUP: 1.50 - <u>2.20</u> - 3.00			

Settings

ON: The colorimetry set using **F•2** COLORIMETRY and the gamma value set with **F•5** GAMMA SETUP are used. However, this is not applied to the video-signal-waveform, vector, or picture display.

The gamma calculation expression is (input signal level) ^ (gamma value).

Negative input signal values are clipped to zero, regardless of whether **F•3** CLIP is set to on or off.

OFF: The colorimetry standard selected on the SYS menu is used.

12. CIE CHROMATICITY DIAGRAM DISPLAY

12.3 Displaying Cursors

To display a cursor on the chromaticity diagram, follow the procedure shown below. You can move the cursor horizontally using the H POS knob and vertically using the V POS knob. The measured values are shown in the upper right of the display. Press the H POS and V POS knobs to move the cursor to the following position.

Chromaticity diagram display: $(x, y) = (u', v') = (0, 0)$

Color temperature display: Lower left of the display

Procedure

VECT → F•4 CURSOR: ON / OFF

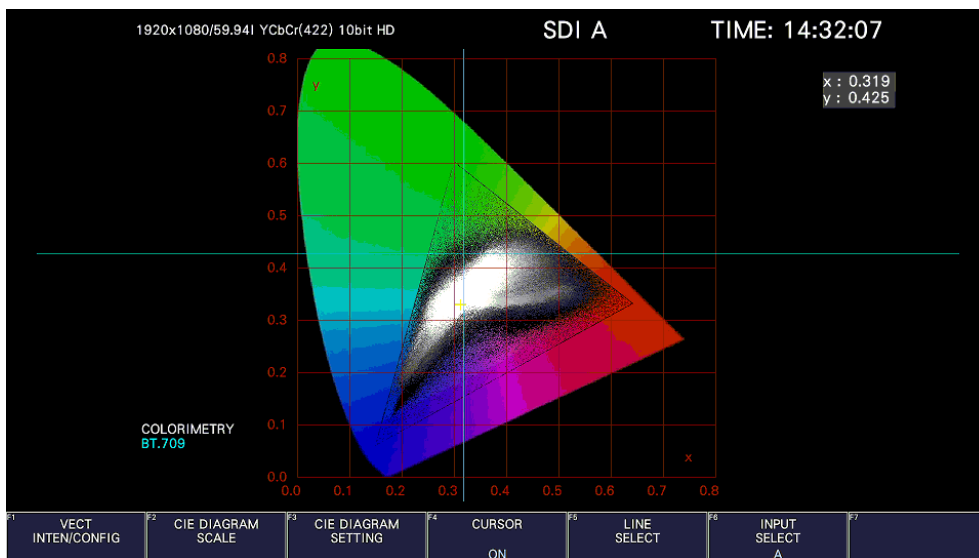

Figure 12-10 Displaying the chromaticity diagram cursor

12.4 Configuring the Line Selection Settings

To configure the line selection settings, press **F•5** LINE SELECT on the VECT menu. See section 11.9.2, "Configuring Line Selection Settings."

13. PICTURE DISPLAY

To display the picture, press PIC.

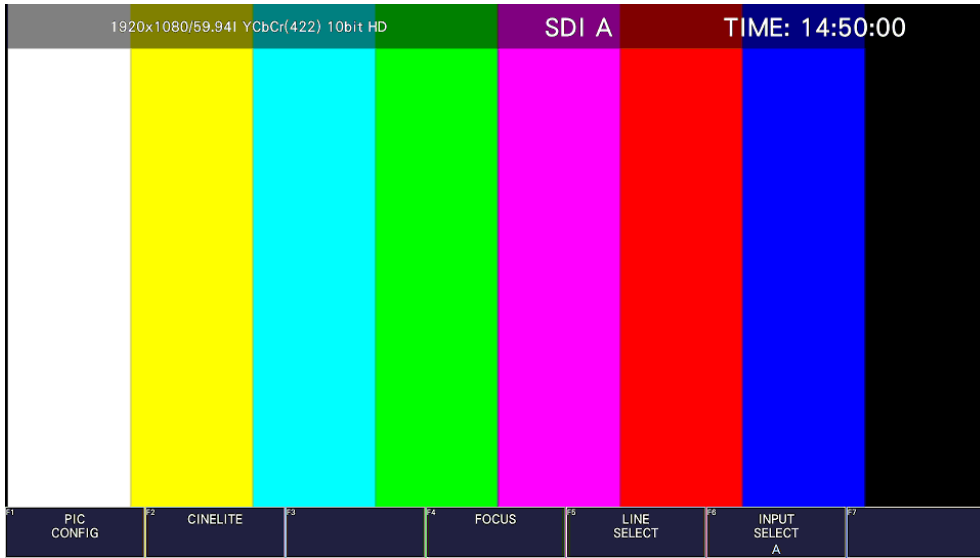

Figure 13-1 Picture display

13. PICTURE DISPLAY

13.1 Selecting the Display Mode

To select the picture display mode, follow the procedure below.

Procedure

PIC	→	F•1	PIC CONFIG	→	F•1	PICTURE MODE: <u>FIT</u> / REAL / X2 / FULL FRM
-----	---	-----	------------	---	-----	---

Settings

- FIT:** The picture is displayed at the optimal size for the display area. Because the picture is enlarged or reduced, the display may become coarse or pixels may drop out. The instrument uses simple filtering to enlarge and reduce the picture.
- REAL:** A single sample of the video signal is displayed with a single pixel on the screen. If the picture is larger than the display area, use the V•POS and H•POS knobs to adjust the picture display position. Press a knob to return the picture to the corresponding default location.
- X2:** A single sample of the video signal is displayed with 4 pixels (2 horizontal and 2 vertical pixels) on the screen. If the picture is larger than the display area, use the V•POS and H•POS knobs to adjust the picture display position. Press a knob to return the picture to the corresponding default location. This is not displayed for 4K.
- FULL FRM:** A single frame, including the blanking interval, is displayed. This is not displayed for 4K.

SIZE = FIT

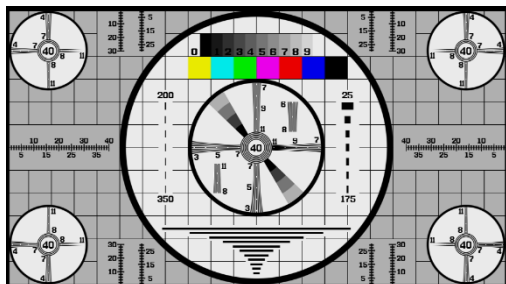

SIZE = REAL

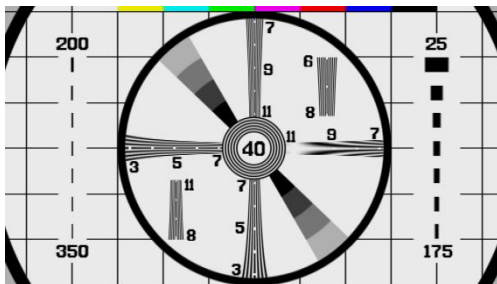

SIZE = X2

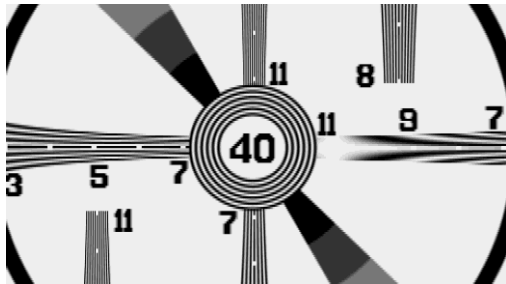

SIZE = FULL FRM

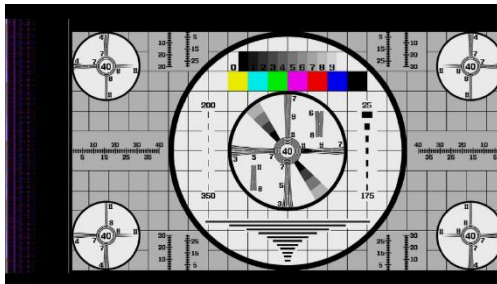

Figure 13-2 Selecting the display mode

13.2 Adjusting the Picture

To adjust the picture, press **F•2** ADJUST in the PIC CONFIG menu.

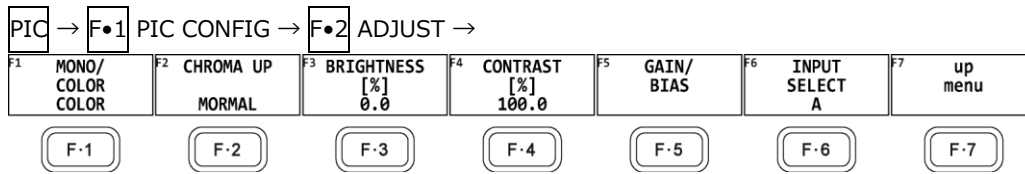
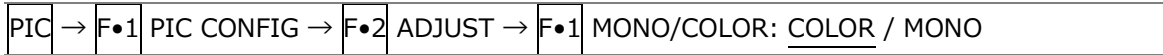

Figure 13-3 ADJUST menu

13.2.1 Switching between the Color and Monochrome Displays

To switch between the color and monochrome displays, follow the procedure below. This setting works in conjunction with Displaying COLORIMETRY ZONE. [See also] 13.3.2, "Displaying COLORIMETRY ZONE (SER31)."

Procedure



13.2.2 Setting the Chroma Gain

To switch the chroma gain, follow the procedure below.

Procedure

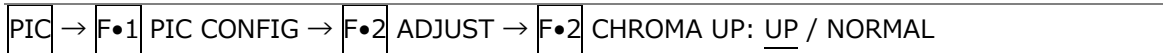

Settings

UP: The chroma gain is set to 2 (200.0 %).
 NORMAL: The chroma gain is set to the value that you have set using **F•5** GAIN/BIAS → **F•1** GAIN.

13.2.3 Adjusting the Brightness

To adjust the brightness, follow the procedure below. Press the function dial (F•D) to return the setting to its default value (0.0).

Procedure

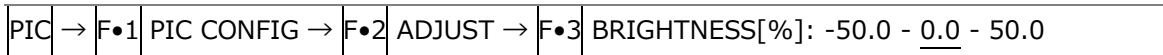

13.2.4 Adjusting the Contrast

To adjust the contrast, follow the procedure below. Press the function dial (F•D) to return the setting to its default value (100.0).

Procedure

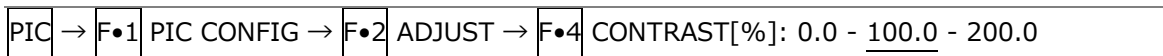

13. PICTURE DISPLAY

13.2.5 Adjusting the Gain

To adjust the gain, press **F•1** GAIN on the GAIN/BIAS menu.

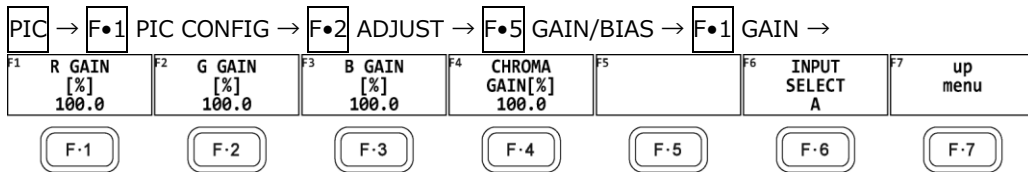

Figure 13-4 GAIN menu

To adjust the gain separately for the R, G, B, and chroma signals, follow the procedure below.

Press the function dial (F•D) to return the setting to its default value (100.0).

When **F•2** CHROMA UP is set to UP, **F•4** CHROMA GAIN does not appear. If is fixed at 200.0.

Procedure

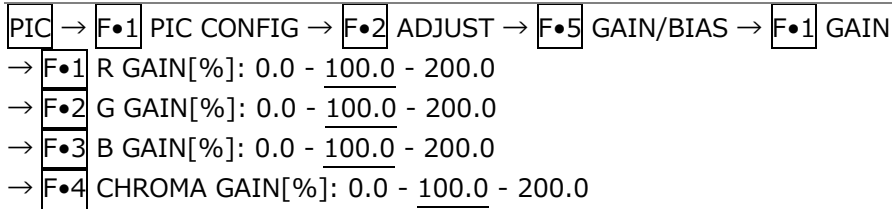

13.2.6 Adjusting the Bias

To adjust the bias, press **F•2** BIAS on the GAIN/BIAS menu.

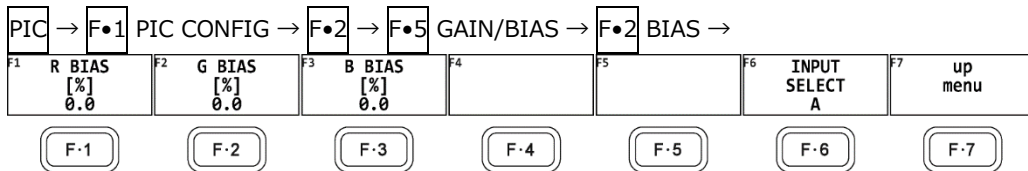
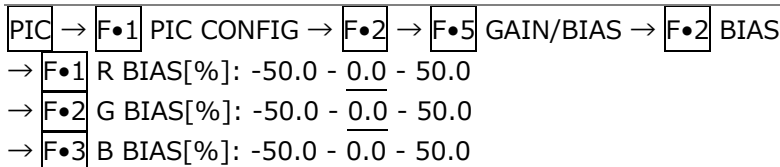

Figure 13-5 BIAS menu

To set the RGB signal bias separately for each color, follow the procedure below.

Press the function dial (F•D) to return the setting to its default value (0.0).

Procedure



13.3 Configuring the Display Settings

To configure the display settings, press **F•3** INDICATION SETTING on the PIC CONFIG menu.

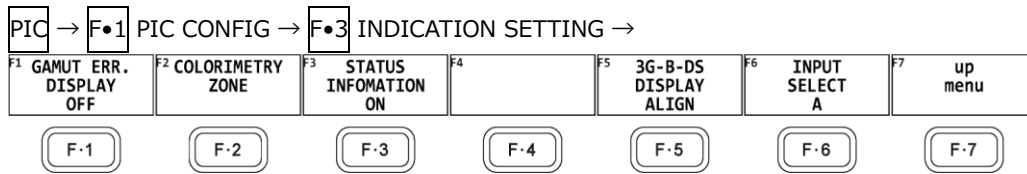

Figure 13-6 INDICATION SETTING menu

13.3.1 Displaying Gamut Errors

To display the locations of gamut errors and luminance errors on the picture, follow the procedure below.

These errors are defined by the ranges that you specify by setting Gamut Upper and Gamut Lower, Composite Upper and Composite Lower, and Luminance Upper and Luminance Lower in the status menu. If Gamut Error, Composite Gamut Error, or Level Error is set to OFF, the corresponding errors are not displayed.

[See also] Gamut Upper/Lower, Composite Upper/Lower → 16.2.3, “Error Setup 3”
 Luminance Upper/Lower → 16.2.4, “Error Setup 4”

Procedure

PIC → **F•1** PIC CONFIG → **F•3** INDICATION SETTING → **F•1** GAMUT ERR. DISPLAY: OFF / WHITE / RED / MESH

Settings

- OFF: Gamut errors are not displayed.
- WHITE: The picture intensity is halved, and gamut error are marked in white.
- RED: The picture intensity is halved, and gamut error are marked in red.
- MESH: Gamut errors are marked with a mesh pattern.

13.3.2 Displaying COLORIMETRY ZONE (SER31)

To display the colorimetry zone, follow the procedure below.

In the colorimetric zone display, colors inside the ITU-R BT.2020 color gamut and outside the ITU-R BT.709 or DCI color gamut are displayed as a mesh pattern on the picture.



Figure 13-7 Colorimetry zone display (green mesh pattern)

- Selecting the colorimetry

To select the colorimetry inside the colorimetry zone, follow the procedure below.

Procedure

PIC	→	F•1	PIC CONFIG	→	F•3	INDICATION SETTING	→	F•2	COLORIMETRY ZONE	→
F•1										OUT OF COLOR ZONE SET: <u>BT-709</u> / DCI

- Selecting the mesh pattern color

To select the mesh pattern color in the colorimetry zone, follow the procedure below.

When set other than OFF and a signal other than ITU-R BT.2020 is input, "Input signal is not BT-2020" is displayed in the center of the screen.

Procedure

PIC	→	F•1	PIC CONFIG	→	F•3	INDICATION SETTING	→	F•2	COLORIMETRY ZONE	→
F•2										COLORIMETRY ZONE: <u>OFF</u> / MESH.G / MESH.B / MESH.M

Settings

OFF:	Does not display the colorimetry zone.
MESH.G:	Displays the colorimetry zone with the 50% green mesh pattern.
MESH.B:	Displays the colorimetry zone with the 50% blue mesh pattern.
MESH.M:	Displays the colorimetry zone with the 50% magenta mesh pattern.

13. PICTURE DISPLAY

- Selecting the mesh pattern size

To select the mesh pattern size, follow the procedure below.

Procedure

PIC	→	F•1	PIC CONFIG	→	F•3	INDICATION SETTING	→	F•2	COLORIMETRY ZONE	→
F•3	MESH SIZE: <u>X1</u> / X2 / X4 / X6 / X8									

- Switching between the color and monochrome displays

To switch between the color and monochrome displays, follow the procedure below. This setting works in conjunction with Switching between the Color and Monochrome Displays.

[See also] 13.2.1, "Switching between the Color and Monochrome Displays."

Procedure

PIC	→	F•1	PIC CONFIG	→	F•3	INDICATION SETTING	→	F•2	COLORIMETRY ZONE	→
F•4	MONO/COLOR: <u>COLOR</u> / MONO									

- Turning the gamut color log On and Off

To display the gamut color log setting screen, follow the procedure below.

Procedure

PIC	→	F•1	PIC CONFIG	→	F•3	INDICATION SETTING	→	F•2	COLORIMETRY ZONE	→
F•5	LOG SET									

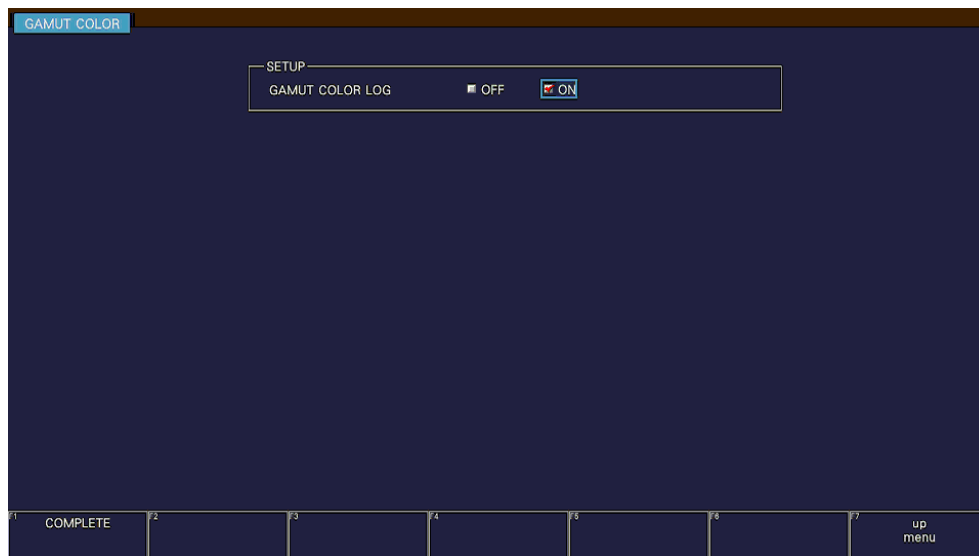

Figure 13-8 Gamut color log setting screen

- GAMUT COLOR LOG

To turn the gamut color log on and off.

When set to on, if there is any color other than the set colorimetry, it is recorded as the event log.

This setting is valid when the colorimetry of the input signal is ITU-R BT.2020 and COLORIMETRY ZONE is set to other than OFF.

[See also] 16.4, "Configuring Event Log Settings."

OFF / ON

13. PICTURE DISPLAY

13.3.3 Turning the Information On and Off

To turn on and off the display of the following information that you arranged in the layout, follow the procedure below.

This setting is valid on the display that appears when PIC is pressed. For multi display and other displays, it is fixed to ON.

- Sub tab items (FORMAT, INPUT, TIME, DATE)
- Option tab options (Format, Input, Time)

Procedure

PIC → F•1 PIC CONFIG → F•3 INDICATION SETTING → F•3 STATUS INFORMATION: ON / OFF

STATUS INFO = ON

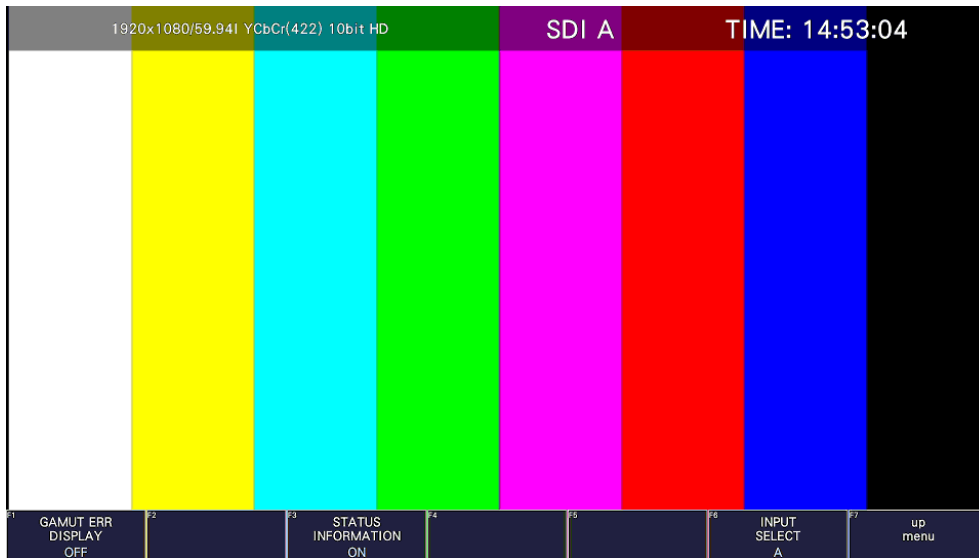

Figure 13-9 Turning the information on and off

13. PICTURE DISPLAY

13.3.4 Configuring the SCTE-104 Detection Display settings

To superimpose the SCTE-104 detection packets up to 3 types on the picture. On the SCTE-104 SETUP tab, you can set the SCTE-104 detection display.

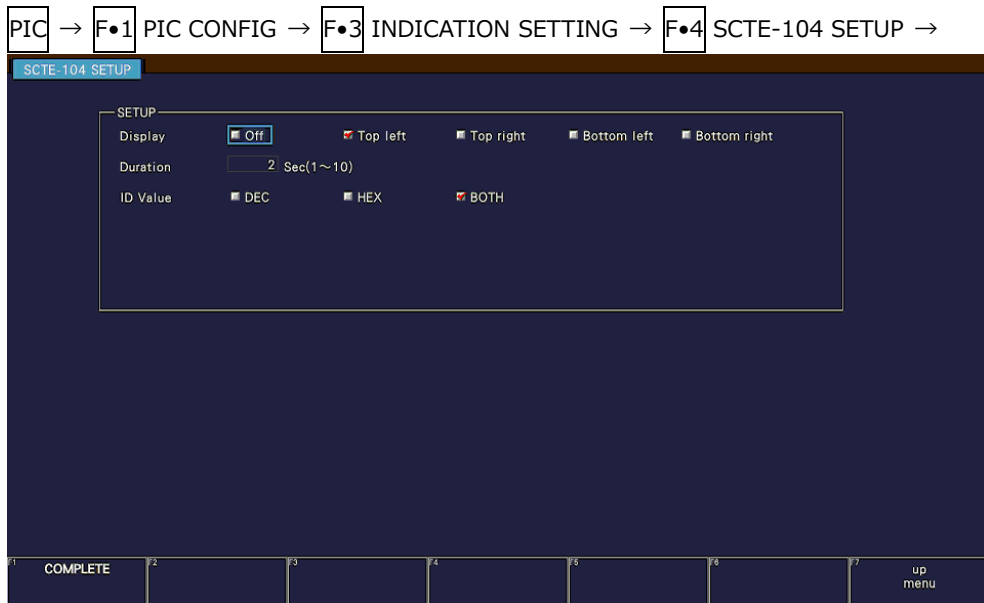

Figure 13-10 SCTE-104 SETUP tab

- Display

Select the display location of SCTE-104 detection from the upper left, upper right, lower left, or lower right of the screen.

If you select off, the SCTE-104 detection is not displayed.

OFF / Top left / Top right / Bottom left / Bottom right

- Duration

Select the display time of the SCTE-104 detection message from 1 to 10 seconds.

It doesn't work in conjunction with the SCTE-104 packet display time of the status display.

1 / 2 / 3 / 4 / 5 / 6 / 7 / 8 / 9 / 10

- ID Value

Select the message display format from HEX (hexadecimal display), DEC (decimal display), or BOTH for the SCTE-104 detection.

It works in conjunction with F•3 ID VALUE on the SPLICE display screen of the status display.

When ID Value is set to BOTH, splice_event_id and unique_program_id are displayed simultaneously in hexadecimal and decimal numbers as shown below.

Splice ID	Hexadecimal (decimal)
Program ID	Hexadecimal (decimal)

DEC / HEX / BOTH

13. PICTURE DISPLAY

13.3.5 Displaying the SCTE-104 Detection screen

When a SCTE-104 message is detected, the message is displayed on the picture screen. Up to 3 messages are displayed, and the top of the messages is the latest detected message. The message is displayed for the time set in Duration, and if no message is detected during the set time, it returns to the hidden state.

- (Time Code) xx:xx:xx:xx SCTE104: (Message 1) Latest detected message
- (Time Code) xx:xx:xx:xx SCTE104: (Message 2) Once ago detected message
- (Time Code) xx:xx:xx:xx SCTE104: (Message 3) Twice ago detected message

When a splice_request_data message is detected, the details of the message are displayed.

Display = Top left / ID Value = BOTH



Figure 13-11 SCTE-104 Detection screen

13. PICTURE DISPLAY

- Displaying abbreviated message

The detected message is abbreviated as shown below.

SCTE-104 message	Abbreviated message
init_request_data	init
alive_request_data	alive
config_request_data	config
fault_request_data	fault
inject_section_data_request	inject_section
splice_request_data	splice
splice_null_request_data	splice_null
start_schedule_download_request_data	start_schedule_down
time_signal_request_data	time_signal
transmit_schedule_request_data	transmit_schedule
component_mode_DPI_request_data	comp_mode_DPI
encrypted_DPI_request_data	encrypted_DPI
insert_descriptor_request_data	insert_desc
insert_DTMF_descriptor_request_data	insert_DTMF_desc
insert_avail_descriptor_request_data	insert_avail_desc
insert_segmentation_descriptor_request_data	insert_seg_desc
proprietary_command_request_data	proprietary_command
schedule_component_mode_request_data	schedule_comp_mode
schedule_definition_data	schedule_definition
insert_tier_data	insert_tier
insert_time_descriptor	insert_time_desc
insert_audio_descriptor	insert_audio_desc
delete_ControlWord_data	delete_ControlWord
update_ControlWord_data	update_ControlWord

splice_request_data message	Abbreviated message
splice_insert_type	SpliceType
splice_event_id	SpliceID
unique_program_id	ProgramID
pre_roll_time	PreRoll
break_duration	Break
avail_num	AvailNum
avails_expected	AvailsExp
auto_return_flag	AutoReturn

13. PICTURE DISPLAY

13.3.6 Configuring the 3G-B DS Display Setting

When measuring 3G-B DS, to select the display mode, follow the procedure below.

Procedure

PIC → F•1 PIC CONFIG → F•3 INDICATION SETTING → F•5 3G-B-DS DISPLAY: STREAM1 /
STREAM2 / ALIGN

Settings

STREAM1: Stream 1 is displayed.

STREAM2: Stream 2 is displayed.

ALIGN: Streams 1 and 2 are displayed side by side.

3G-B-DS DISPLAY = ALIGN

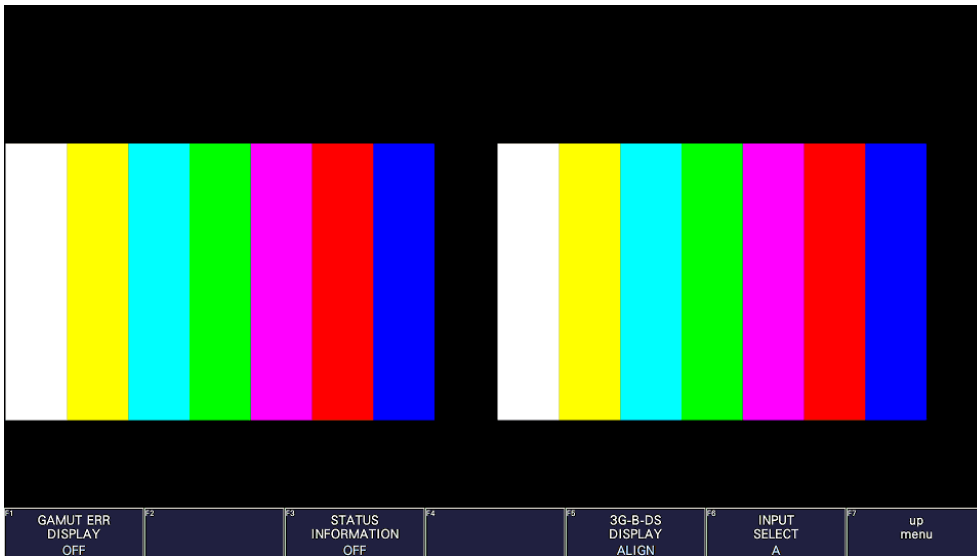

Figure 13-12 Configuring the 3G-B DS Display

13.4 Configuring the Marker Settings

To configure the marker settings, press **F•4** MARKER on the PIC CONFIG menu. This menu item does not appear when PICTURE MODE is set to a value other than FIT. [See also] PICTURE MODE → 13.1, "Selecting the Display Mode"

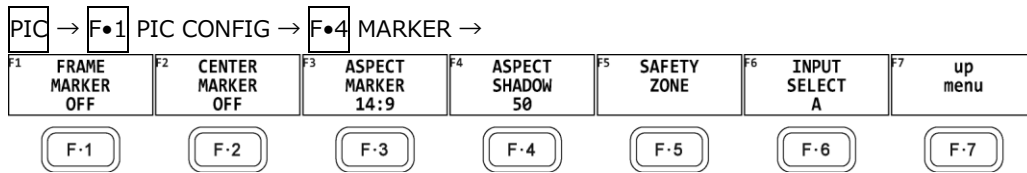

Figure 13-13 MARKER menu

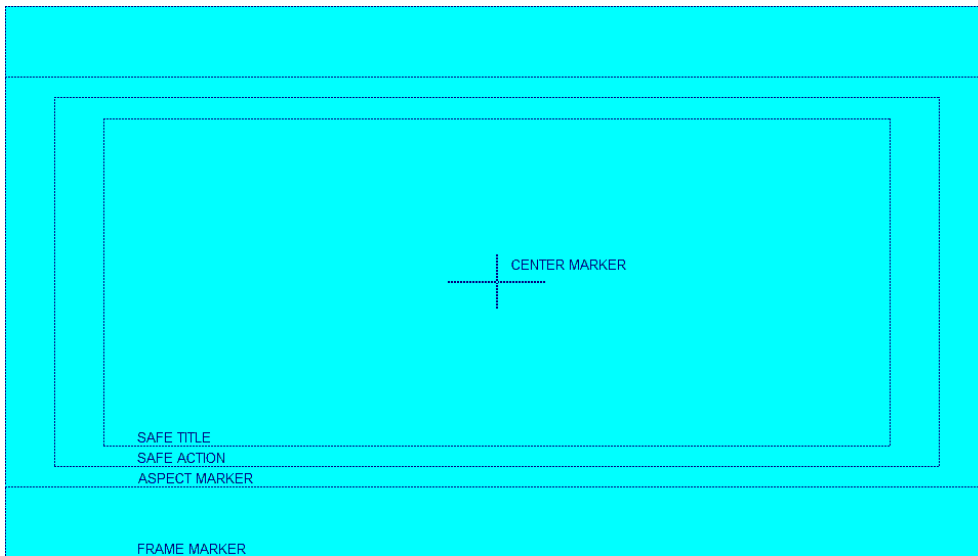
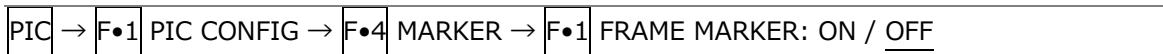

Figure 13-14 Horizontal marker display

13.4.1 Turning the Frame Marker On and Off

To turn the frame marker on and off, follow the procedure below.

Procedure



13.4.2 Turning the Center Marker On and Off

To turn the center marker on and off, follow the procedure below.

Procedure

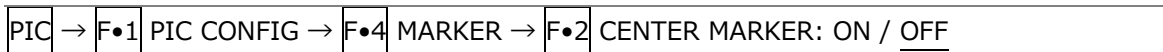

13.4.3 Setting the Aspect Marker

To display the aspect marker, follow the procedure below.

Procedure

PIC → F•1 PIC CONFIG → F•4 MARKER → F•3 ASPECT MARKER: OFF / 17:9 / 16:9 / 14:9 / 13:9 / 4:3 / 2.39:1 / AFD

Settings

OFF:	The aspect marker is not displayed.
17:9	A 17:9 aspect marker is displayed. This option cannot be selected when the input signal is a 17:9 frame signal or an SD signal.
16:9:	A 16:9 aspect marker is displayed. This option cannot be selected when the input signal is a 16:9 frame signal.
14:9:	A 14:9 aspect marker is displayed.
13:9:	A 13:9 aspect marker is displayed.
4:3:	A 4:3 aspect marker is displayed. This option cannot be selected when the input signal is SD.
2.39:1:	A 2.39:1 aspect marker is displayed. This option cannot be selected when the input signal is SD.
AFD:	The aspect marker included in the AFD (Active Format Description) packets is displayed. Also, abbreviations for SMPTE ST 2016-1-2007 standard AFD codes are displayed in the upper left of the screen. This option can be selected when the input signal is SD or HD.

13. PICTURE DISPLAY

The AFD codes that are displayed in the upper left of the screen are displayed as shown below according to the coded frame and the AFD code. If there are no AFD packets embedded in the input signal, "-----" is displayed.

Table 13-1 AFD display

Displayed Abbreviation	Coded Frame	AFD Code	Description
0000- UNDEFINED	0 (4:3)	0000	Undefined
0001- RESERVED	0 (4:3)	0001	Reserved
0010- 16:9LBTOP	0 (4:3)	0010	Letterbox 16:9 image, at top of the coded frame
0011- 14:9LBTOP	0 (4:3)	0011	Letterbox 14:9 image, at top of the coded frame
0100- >16:9LBox	0 (4:3)	0100	Letterbox image with an aspect ratio greater than 16:9, vertically centered in the coded frame
0101- RESERVED	0 (4:3)	0101	Reserved
0110- RESERVED	0 (4:3)	0110	Reserved
0111- RESERVED	0 (4:3)	0111	Reserved
1000- FullFrame	0 (4:3)	1000	Full frame 4:3 image, the same as the coded frame
1001- Full Frame	0 (4:3)	1001	Full frame 4:3 image, the same as the coded frame
1010- 16:9LBox	0 (4:3)	1010	Letterbox 16:9 image, vertically centered in the coded frame with all image areas protected
1011- 14:9LBox	0 (4:3)	1011	Letterbox 14:9 image, vertically centered in the coded frame
1100- RESERVED	0 (4:3)	1100	Reserved
1101-4:3Full14:9	0 (4:3)	1101	Full frame 4:3 image, with alternative 14:9 center
1110-16:9LB14:9	0 (4:3)	1110	Letterbox 16:9 image, with alternative 14:9 center
1111-16:9LB4:3	0 (4:3)	1111	Letterbox 16:9 image, with alternative 4:3 center
0000w UNDEFINED	1 (16:9)	0000	Undefined
0001w RESERVED	1 (16:9)	0001	Reserved
0010w Full Frame	1 (16:9)	0010	Full frame 16:9 image, the same as the coded frame
0011w 14:9Pillbox	1 (16:9)	0011	Pillarbox 14:9 image, horizontally centered in the coded frame
0100w >16:9LBox	1 (16:9)	0100	Letterbox image with an aspect ratio greater than 16:9, vertically centered in the coded frame
0101w RESERVED	1 (16:9)	0101	Reserved
0110w RESERVED	1 (16:9)	0110	Reserved
0111w RESERVED	1 (16:9)	0111	Reserved
1000w FullFrame	1 (16:9)	1000	Full frame 16:9 image, the same as the coded frame
1001w 4:3Pillbox	1 (16:9)	1001	Pillarbox 4:3 image, horizontally centered in the coded frame
1010w FullNoCrop	1 (16:9)	1010	Full frame 16:9 image, with all image areas protected
1011w14:9Pillbox	1 (16:9)	1011	Pillarbox 14:9 image, horizontally centered in the coded frame
1100w RESERVED	1 (16:9)	1100	Reserved
1101w4:3PB14:9	1 (16:9)	1101	Pillarbox 4:3 image, with alternative 14:9 center
1110wFul14:9Safe	1 (16:9)	1110	Full frame 16:9 image, with alternative 14:9 center
1111wFull4:3Safe	1 (16:9)	1111	Full frame 16:9 image, with alternative 4:3 center

13. PICTURE DISPLAY

13.4.4 Setting the Aspect Shadow

When **F•3** ASPECT MARKER is set to a value other than OFF, to adjust the darkness of the aspect marker shadow, follow the procedure below. The larger the number, the darker the shadow. If you specify 0, the aspect marker will be indicated with a line.

Press the function dial (F•D) to return the setting to its default value (50).

Procedure

PIC → F•1 PIC CONFIG → F•4 MARKER → F•4 ASPECT SHADOW[%]: 0 - 50 - 100

ASPECT SHADOW = 50

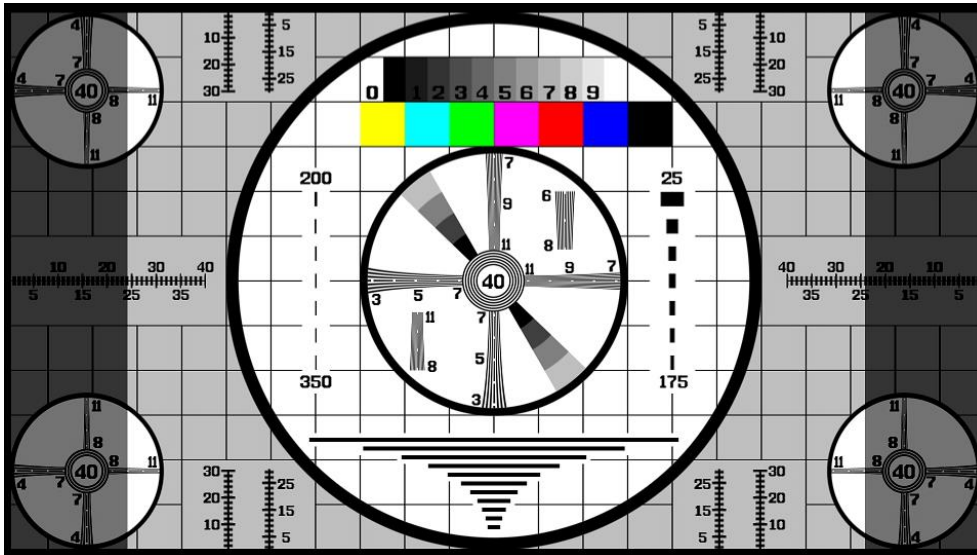

Figure 13-15 Setting the aspect shadow

13. PICTURE DISPLAY

13.4.5 Setting the Safe Action Marker

To configure safety marker settings, press **F•5** SAFETY ZONE on the MARKER menu. When **F•3** ASPECT MARKER is set to AFD, this menu item is not available.

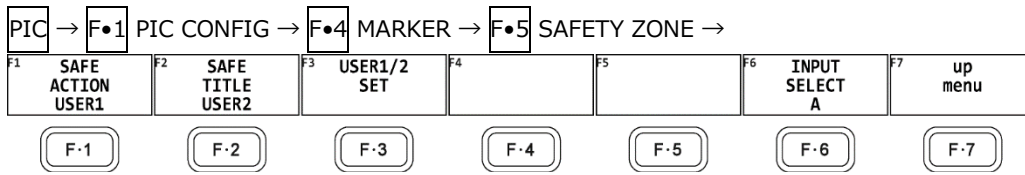

Figure 13-16 SAFETY ZONE menu

To display the safe action marker, follow the procedure below.

When an aspect marker is displayed, the safe action marker is displayed relative to the aspect marker.

Procedure

PIC → **F•1** PIC CONFIG → **F•4** MARKER → **F•5** SAFETY ZONE → **F•1** SAFE ACTION: ARIB / SMPTE / USER1 / OFF

Settings

ARIB:	An ARIB TR-B4 safe action marker is displayed. This setting cannot be selected when the input signal is 4K.
SMPTE:	An SMPTE RP-218 safe action marker is displayed. This setting cannot be selected when the input signal is 4K.
USER1:	A marker that has been set with F•1 USER1 WIDTH[%] and F•2 USER1 HEIGHT[%] for F•3 USER1/2 SET is displayed.
OFF:	A safe action marker is not displayed.

13.4.6 Setting the Safe Title Marker

To display the safe title marker, follow the procedure below.

When an aspect marker is displayed, the safe action marker is displayed relative to the aspect marker.

Procedure

PIC → **F•1** PIC CONFIG → **F•4** MARKER → **F•5** SAFETY ZONE → **F•2** SAFE TITLE: ARIB / SMPTE / USER2 / OFF

Settings

ARIB:	An ARIB TR-B4 safe title marker is displayed. This setting cannot be selected when the input signal is 4K.
SMPTE:	An SMPTE RP-218 safe title marker is displayed. This setting cannot be selected when the input signal is 4K.
USER2:	A marker that has been set with F•3 USER2 WIDTH[%] and F•4 USER2 HEIGHT[%] for F•3 USER1/2 SET is displayed.
OFF:	A safe title marker is not displayed.

13. PICTURE DISPLAY

13.4.7 Setting User Markers

By setting **F•1** SAFE ACTION to USER1 and **F•2** SAFE TITLE to USER2, you can display up to two user-defined markers.

To configure user-defined marker settings, press **F•3** USER1/2 SET on the SAFETY ZONE menu.

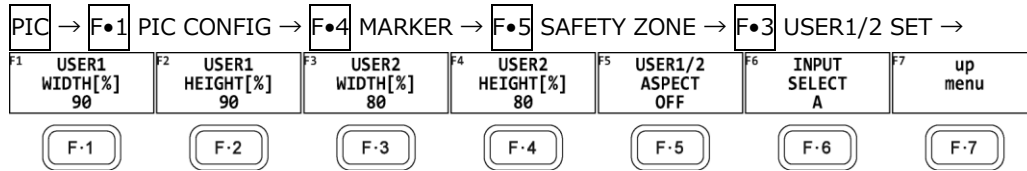

Figure 13-17 USER1/2 SET menu

To set the width and height of a user marker and turn the aspect ratio display on and off, follow one of the procedures below.

Press the function dial (F•D) to return the width and height settings to their default value.

The aspect ratio display on/off setting applies both to USER1 and USER2.

Procedure

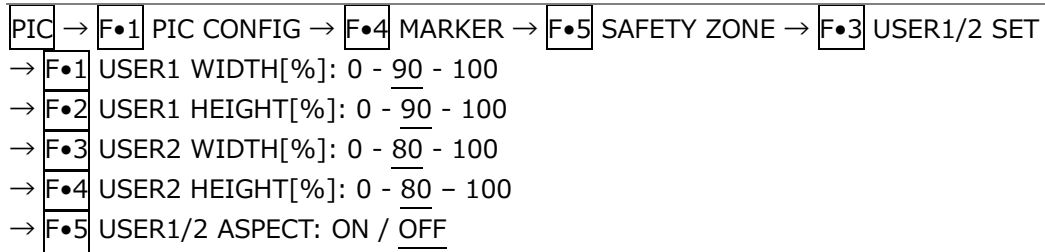

13.5 Setting the Superimpose Feature

The superimpose feature displays closed caption information on top of pictures.

To display the closed caption information, press **F•5** SUPER IMPOSE on the PIC CONFIG menu.

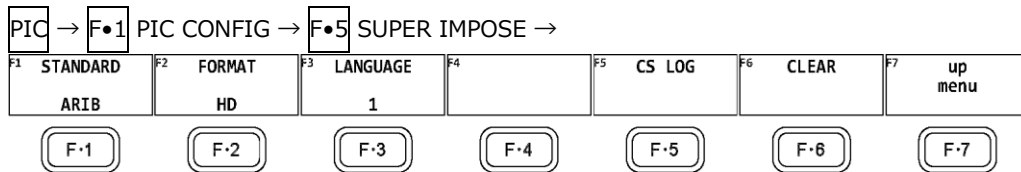

Figure 13-18 SUPER IMPOSE menu

13.5.1 Selecting the Closed Caption Display

To select the closed caption to display over the picture, follow the procedure below. If you select OFF, no closed captions will be displayed.

Procedure

PIC → **F•1** PIC CONFIG → **F•5** SUPER IMPOSE → **F•1** STANDARD: OFF / SMPTE / ARIB / TELETEXT

Settings

OFF:	Closed captions are not displayed.
SMPTE:	English closed captions are displayed. This cannot be selected in 3G-B DS, or 3G(DL)-2K.
ARIB:	Simple Japanese closed captions are displayed. This cannot be selected in 3G-B, or 3G(DL)-2K.
TELETEXT:	European closed captions are displayed. This can be selected in SD or HD.

On the Japanese closed caption display, if a clear screen command is received, "CS" is displayed in cyan for approximately 0.5 seconds in the upper right of the screen.

13.5.2 Selecting the Format of English Closed Captions

To select the English closed caption format from the four types below, follow the procedure below.

Procedure

PIC → **F•1** PIC CONFIG → **F•5** SUPER IMPOSE → **F•2** FORMAT: 608(708) / 608(608) / VBI / 708

Settings

608(708):	CEA/EIA-608-B English closed caption information that is embedded in EIA-708-B CDP packets is displayed.
608(608):	CEA/EIA-608-B English closed caption information is displayed.
VBI:	CEA/EIA-608-B English closed caption information that is embedded in vertical blanking intervals is displayed. This can be selected in SD.
708:	EIA-708 English closed caption information that is embedded in EIA-708-B CDP packets is displayed.

13. PICTURE DISPLAY

13.5.3 Selecting the Display Details of English Closed Captions

When **F•2** FORMAT is set to a value other than 708, to select the English closed caption content to display, follow the procedure below.

Procedure

PIC → **F•1** PIC CONFIG → **F•5** SUPER IMPOSE → **F•3** LANGUAGE: CC1 / CC2 / CC3 / CC4 / TEXT1 / TEXT2 / TEXT3 / TEXT4

When **F•2** FORMAT is set to 708, to select the English closed caption content to display, follow the procedure below.

Press the function dial (F•D) to return the setting to its default value (1).

Procedure

PIC → **F•1** PIC CONFIG → **F•5** SUPER IMPOSE → **F•4** SERVICE DATA: 1 - 63

13.5.4 Selecting the Format of Japanese Closed Captions

To select the ARIB Japanese closed caption information format from the four types below, follow the procedure below. A border is displayed around the name of the selected format of Japanese closed captions in the upper right of the screen.

The closed caption format names are displayed in green when packets of the corresponding closed caption format are being received and in white otherwise.

Procedure

PIC → **F•1** PIC CONFIG → **F•5** SUPER IMPOSE → **F•2** FORMAT: HD / SD / ANALOG / CELLULAR

Settings

HD:	Displays HD closed caption data
SD:	Displays SD closed caption data
ANALOG:	Displays analog closed caption data
CELLULAR:	Displays porta closed caption data

13.5.5 Selecting the Japanese Closed Caption Data

To select the closed caption data type, follow the procedure below.

Procedure

PIC → **F•1** PIC CONFIG → **F•5** SUPER IMPOSE → **F•3** LANGUAGE: 1 / 2

Settings

1:	Language 1
2:	Language 2

13. PICTURE DISPLAY

13.5.6 Displaying the Clear Screen Log

You can detect the clear screen commands that are embedded in the broadcasts of programs with closed captions and display a log of these commands. In addition, using specified timecodes, you can check whether closed captions in TV commercial materials are displayed during the closed caption prohibited time.

Carry out the procedure below to display the clear screen command log.
Use the CS LOG menu to set the clear screen log.

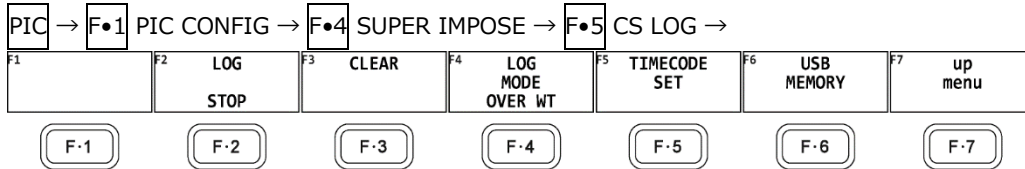

Figure 13-19 CS LOG menu

Log screen

CS LOG LIST		SAMPLE No.10		<< NOW LOGGING >>		
4:	LTC TC20:32:56:01	A	HD	1080i/59.94	T_DSP	
3:	LTC TC20:32:56:01	A	HD	1080i/59.94	CS	
2:	LTC TC20:32:54:01	A	HD	1080i/59.94	T_DSP	
1:	LTC TC20:32:54:01	A	HD	1080i/59.94	CS	
1	2	3	4	5	6	

1. Generation Number
2. Time Code
3. Input channel
4. Closed caption format
5. Input format
6. Log Entry Contents

- * Even if there are several of these units installed in the instrument, there is only one log file.
- * The clear screen log can be recorded when the Japanese closed caption screen or the clear screen log screen is displayed. Use the multi screen display or other means to keep these screens from closing during measurement.
- * If you rewind a VCR, reset the log buffer before starting the clear screen log. Use START/STOP of F•2 LOG or F•6 CLEAR (Japanese closed caption screen) on the F•3 CLEAR, SUPER IMPOSE menu to reset.
- * The clear screen log recording period is approximately 83 minutes when the closed caption changes every 2 seconds.
- * Closed caption codes and decoded closed captions cannot be logged.

13. PICTURE DISPLAY

- General Display Description

- Generation Number

The clear screen log entries are listed in order with the most recent events listed first. By turning the function dial (F•D) to the right, you can scroll the screen to view older entries in the log. Press the function dial (F•D) to display the latest entries in the log.

- Time Code

In the clear screen log, entries are recorded using the time code specified on the CAPTURE & DISPLAY tab of the SYS menu. Set the time code to LTC or VITC. D-VITC is not supported.

[See also] 7.2.5, "Configuring the Information Display"

- Log Entry Contents

The meanings of the displayed log contents are shown below.

CS: Detection of a clear screen command

T_DSP: Detection of closed caption display

- Starting or Stopping the Log

To start or stop the clear screen log, follow the procedure below.

Procedure

PIC	→	F•1	PIC CONFIG	→	F•5	SUPER IMPOSE	→	F•5	CS LOG	→	F•2	LOG: START / <u>STOP</u>
-----	---	-----	------------	---	-----	--------------	---	-----	--------	---	-----	--------------------------

- Clearing the Log

To clear the clear screen log, follow the procedure below.

Procedure

PIC	→	F•1	PIC CONFIG	→	F•5	SUPER IMPOSE	→	F•5	CS LOG	→	F•3	CLEAR
-----	---	-----	------------	---	-----	--------------	---	-----	--------	---	-----	-------

- Log Operation Mode

The clear screen log can record up to 5,000 entries.

To select the action to perform when more than 5,000 events occur, follow the procedure below.

Procedure

PIC	→	F•1	PIC CONFIG	→	F•5	SUPER IMPOSE	→	F•5	CS LOG	→	F•4	LOG MODE: <u>OVER</u> <u>WT / STOP</u>
-----	---	-----	------------	---	-----	--------------	---	-----	--------	---	-----	---

Settings

OVER WT: Old logs are discarded and overwritten.

STOP: Logs after the 5,000 events are not recorded.

13. PICTURE DISPLAY

- Configuring the Closed Caption Checking Function

Carry out the procedure below to check whether a closed caption is displayed during the closed caption prohibited time.

Procedure

PIC	→	F•1	PIC CONFIG	→	F•5	SUPER IMPOSE	→	F•5	CS LOG	→	F•5	TIMECODE SET
-----	---	-----	------------	---	-----	--------------	---	-----	--------	---	-----	--------------

Settings

OFF:	Closed caption checking is disabled (log will be recorded).
Timecode:	Closed caption checking is enabled.

- Start Time and End Time

If you select Timecode, set the check period to 4 s or longer using Start Time and End Time. If Time Code on the SYS menu is set to Real Time, you cannot set the trigger.

- Non Caption Time

Under Non Caption Time, set the closed caption prohibited time. If closed captions are displayed between Start Time and Front seconds after Start Time or between Rear seconds before End Time to End Time, the check result will be NG.

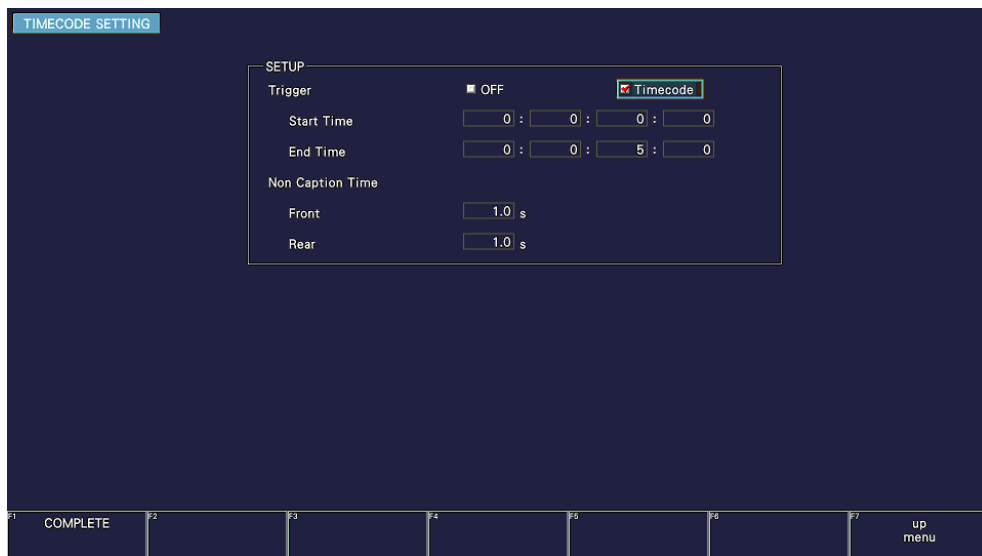

13. PICTURE DISPLAY

- Saving Data to a USB Memory Device

You can save the clear screen log to a USB memory device as a text file.
To save a file with a name that you specify, follow the procedure below.

1. Used to connect USB memory.
2. Press **F•6** USB MEMORY.

The file list screen appears.

This setting appears when a USB memory device is connected.

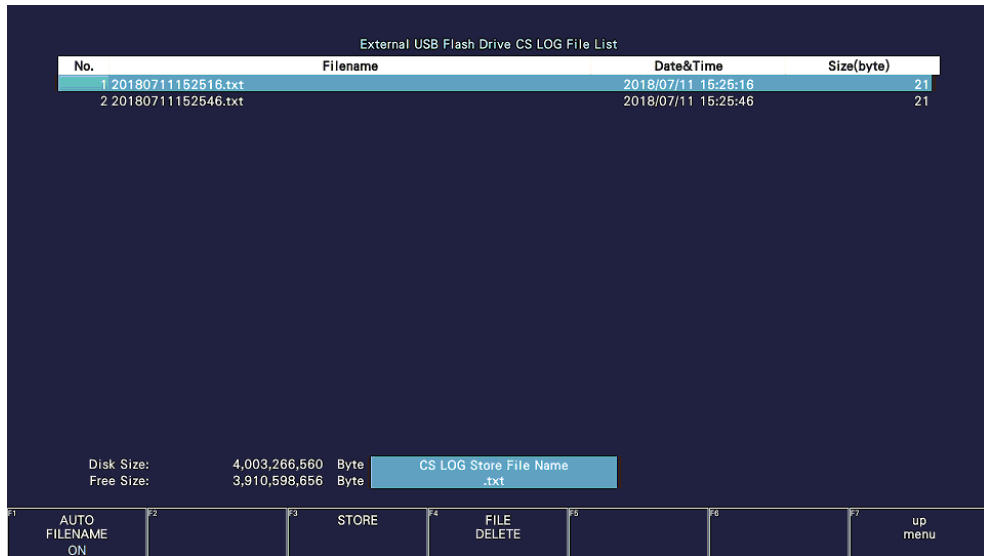

Figure 13-20 File list screen

3. Set **F•1** AUTO FILENAME to OFF.
4. Press **F•2** NAME INPUT.

The file name input display appears.

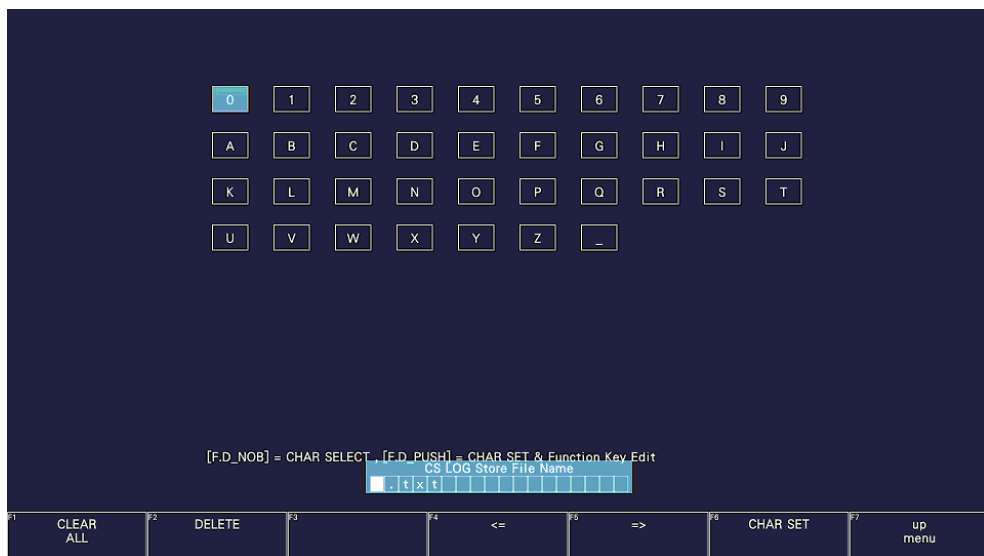

Figure 13-21 File name input screen

13. PICTURE DISPLAY

5. Enter a file name using up to 14 characters.

The key operations that you can perform in the file name input display are as follows:

F•1	CLEAR ALL	Deletes all characters
F•2	DELETE	Deletes the character at the cursor
F•4	<=	Moves the cursor to the left
F•5	=>	Moves the cursor to the right
F•6	CHAR SET	Enters the character
Function dial (F•D)		Turn to select a character, and press to enter the character.

You can also copy the file name of an already saved file. To copy a file name, move the cursor to the file in the file list whose name you want to copy, and then press the function dial (F•D).

6. Press **F•7** up menu.
7. Press **F•3** STORE.

If a file with the same name that you have specified already exists on the USB memory device, an overwrite confirmation menu appears. To overwrite the existing preset, **F•1** OVER WR YES. Otherwise, press **F•3** OVER WR NO.

- Deleting the Clear Screen Log

To delete a clear screen log that has been saved to the USB memory device, select the log file on the file list display, and then press **F•4** FILE DELETE. To delete the file, press **F•1** DELETE YES. To cancel the delete operation, press **F•3** DELETE NO.

- Automatic File Name Generation

If you set **F•1** AUTO FILENAME to ON, the file name will be generated automatically in the format "YYYYMMDDhhmmss" when you save the file. In this situation, **F•2** NAME INPUT is not displayed.

- USB Memory Device Folder Structure

Clear screen logs are saved in the LOG folder.

- 📁 USB memory device
 - ↳ 📁 LV5600_USER or LV7600_USER
 - ↳ 📁 LOG
 - ↳ 📄 YYYYMMDDhhmmss.txt Clear screen log file (with check result)

13. PICTURE DISPLAY

• Measurement Example

As an example, this section describes how to perform closed caption checking on TV commercial material.

1. On the CAPTURE & DISPLAY tab of the SYS menu, set Time Code to LTC or VITC.
After setting them, press **F•1** COMPLETE.
2. Set **PIC** → **F•1** PIC CONFIG → **F•5** SUPER IMPOSE → **F•1** STANDARD to ARIB.
3. Set **F•2** FORMAT and **F•3** LANGUAGE.
4. Press **F•5** CS LOG.
5. Press **F•5** TIMECODE SET to set the time code.
Set Trigger to Timecode first, and then set the timecode and closed caption prohibited time. After setting them, press **F•1** COMPLETE.
6. Press **F•2** LOG to start the log.
From this point until the end of measurement, do not exit the clear screen log screen or Japanese closed caption screen.
7. Start the TV commercial material.
Closed caption checking will start at the specified time.
On the clear screen log screen, log entries are displayed in red when closed captions are displayed during the closed caption prohibited time and in green otherwise.
8. When the check result is displayed, press any key.
The caption check result is displayed as OK or NG.
9. If necessary, press **F•6** USB MEMORY to save the measurement results to USB memory.

13.5.7 Clearing Japanese Closed Caption Data

To clear the displayed Japanese closed caption, follow the procedure below to press CLEAR.

Procedure

PIC	→	F•1	PIC CONFIG	→	F•5	SUPER IMPOSE	→	F•6	CLEAR
-----	---	-----	------------	---	-----	--------------	---	-----	-------

13. PICTURE DISPLAY

13.5.8 Selecting the Multiplex System for European Closed Captions

To select the multiplex system for European closed captions from the two types below, follow the procedure below.

Procedure

PIC	→	F•1	PIC CONFIG	→	F•5	SUPER IMPOSE	→	F•2	WST TRANSPORT: <u>VBI</u> / OP47
-----	---	-----	------------	---	-----	--------------	---	-----	----------------------------------

Settings

VBI: European closed caption information that is embedded in vertical blanking intervals is displayed.

This can be selected in SD.

OP47: Closed captions in SMPTE RDD-08 SDP format are displayed.

13.5.9 Selecting the Magazine Number and Page Number for European Closed Captions

To select a magazine number for European closed captions, follow the procedure below.

Procedure

PIC	→	F•1	PIC CONFIG	→	F•5	SUPER IMPOSE	→	F•3	MAGAZINE:1 - <u>7</u> - 8
-----	---	-----	------------	---	-----	--------------	---	-----	---------------------------

To select a page number for European closed captions, follow the procedure below.

Procedure

PIC	→	F•1	PIC CONFIG	→	F•5	SUPER IMPOSE	→	F•4	PAGE:00 - <u>77</u> - FF
-----	---	-----	------------	---	-----	--------------	---	-----	--------------------------

13.6 Configuring CINELITE Settings

CINELITE is a feature that displays luminance levels of video signals on the picture. To show the CINELITE display, press **F•2** CINELITE on the PIC menu.

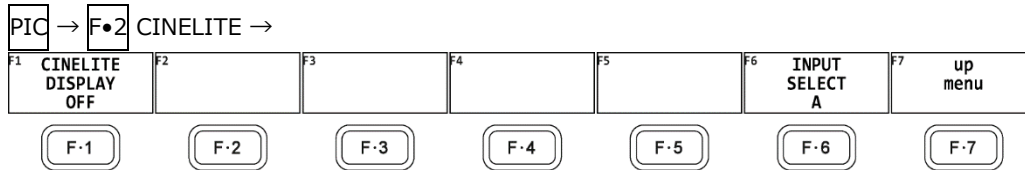

Figure 13-22 CINELITE menu

To switch to the CINELITE display, follow the procedure below.

Procedure

PIC → F•2 CINELITE → F•1 CINELITE DISPLAY: OFF / f Stop / %DISPLAY / CINEZONE / %DISP & CINEZONE

Settings

OFF:	CINELITE is not displayed.
f Stop:	The f Stop screen is displayed. This option cannot be selected in 3G-B DS or when PICTURE MODE is set to a value other than FIT.
%DISPLAY:	The %DISPLAY screen is displayed. This option cannot be selected in 3G-B DS or when PICTURE MODE is set to a value other than FIT.
CINEZONE:	The CINEZONE screen is displayed. This option cannot be selected in 3G-B DS.
%DISP & CINEZONE:	The %DISPLAY screen and the CINEZONE screen are displayed at the same time. This option cannot be selected in 3G-B DS. When PICTURE MODE is set to a value other than FIT, the %DISPLAY screen will not be displayed even if you select %DISP & CINEZONE.

13. PICTURE DISPLAY

13.6.1 f Stop Display Description

To set f Stop, press **F•1** CINELITE DISPLAY to select f Stop and then press **F•2** f STOP SETUP.

On the f Stop display, luminance levels are displayed using f-stop (exposure) values. The measured f Stop value for a group of measured points is typically displayed using white, but it will be displayed using yellow when it corresponds to a luminance level of 80 % or more. Additionally, f Stop values that correspond to luminance levels equal to or less than 0 % cannot be measured. They are displayed in yellow as "*****."

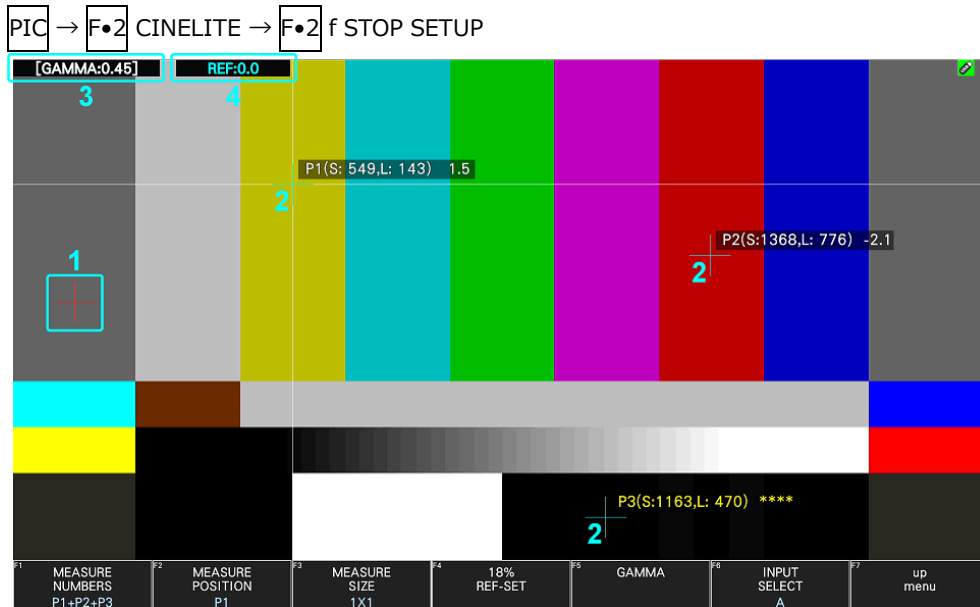

Figure 13-23 f Stop display

1 Reference Position

The position where the cursors intersected when **F•4** 18% REF SET was pressed is displayed in red. This is the reference position for f-stop measurement.

2 Cursor

Up to three cursors can be set. The cursor coordinates are indicated using sample numbers and line numbers. The f Stop value relative to the reference point is displayed at each point.

3 Gamma Correction Value

The gamma correction value that you selected using **F•5** GAMMA → **F•1** GAMMA SELECT is displayed.

4 Reference display

The f Stop value at the reference position is displayed. The value immediately after you have pressed **F•4** 18% REF-SET is zero, but it will change when the picture changes.

13.6.2 Procedure for Displaying the f Stop Display

The following example shows how to display luminance levels as f Stop numbers relative to the luminance level of 18 % gray chart. Include an 18 % gray chart with the objects that you are filming.

1. Press PIC.
2. Press **F•2** CINELITE.
3. Press **F•1** CINELITE DISPLAY to select f Stop.
4. Press **F•2** f STOP SETUP.
5. Press **F•5** GAMMA and then **F•1** GAMMA SELECT to select the gamma correction table type.

The default gamma correction value is 0.45, but you can also use a user-defined gamma correction table that matches the gamma characteristics of the camera that you are using. For details, see section 13.6.7, "Configuring User-Defined Correction Tables." The selected gamma correction value is indicated in the upper left of the display.

6. Press **F•7** up menu.
7. Make sure that the cursors are over the 18 % gray chart, and press **F•4** 18% REF SET. The f Stop value for 18 % gray chart becomes 0.0 and is displayed in the upper part of the screen next to "REF:." The reference position is displayed with a red cursor.
8. Use the cursors to set the measurement points. The f Stop value relative to 18 % gray chart appears next to each cursor. You can set up to three measurement points.

13. PICTURE DISPLAY

13.6.3 %DISPLAY Screen Description

To set %DISPLAY, press **F•1** CINELITE DISPLAY to select %DISPLAY and then press **F•2** %DISP SETUP.

On the %DISPLAY screen, you can display luminance levels using Y%, RGB%, RGB255, CODE VALUE, or CODE VALUE DEC. Use **F•4** UNIT SELECT to select the display format. The measured values are typically displayed in white, but they are displayed in yellow when the luminance level at a measurement point is 80 % or more or 0 % or less. (Except CV)

- Y% Display

Luminance levels are indicated as percentages.

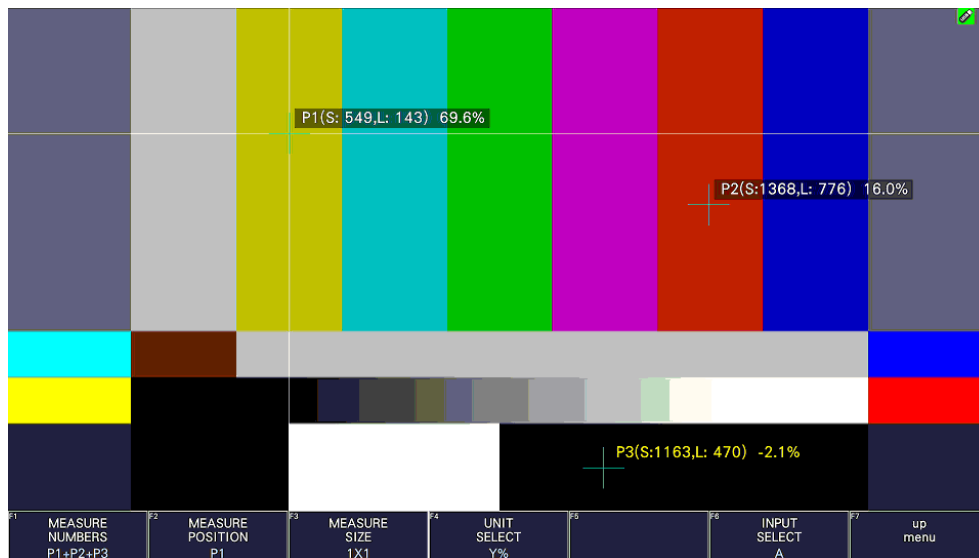

Figure 13-24 Y% display

- RGB% Display

Each of the R, G, and B levels is indicated using a percentage. The levels are also indicated using bars on the left side of the display (the order is R, G, and then B).

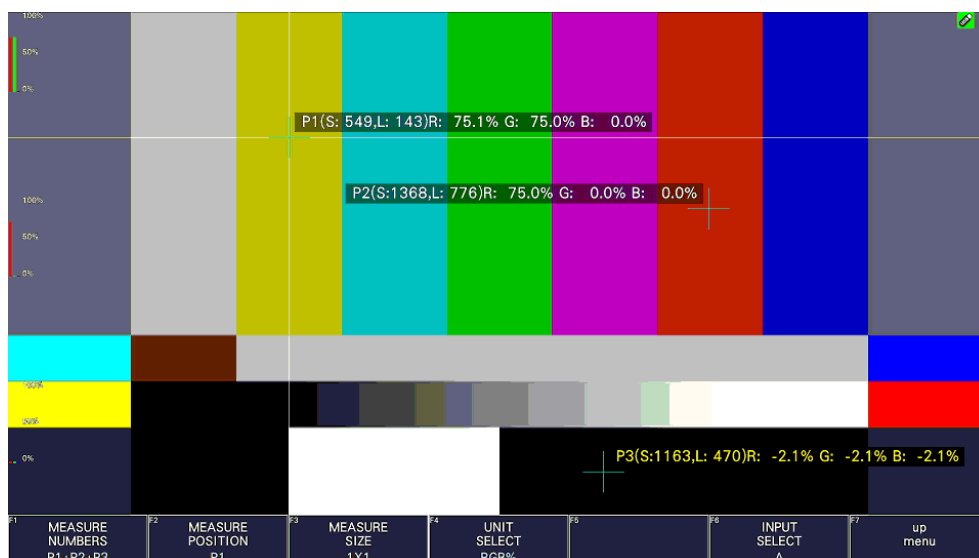

Figure 13-25 RGB% display

13. PICTURE DISPLAY

- RGB255 Display

Each of the R, G, and B levels is indicated using 256 steps from 0 to 255. The levels are also indicated using bars on the left side of the display (the order is R, G, and then B). The value of an RGB level that is 100 % or greater is 255.

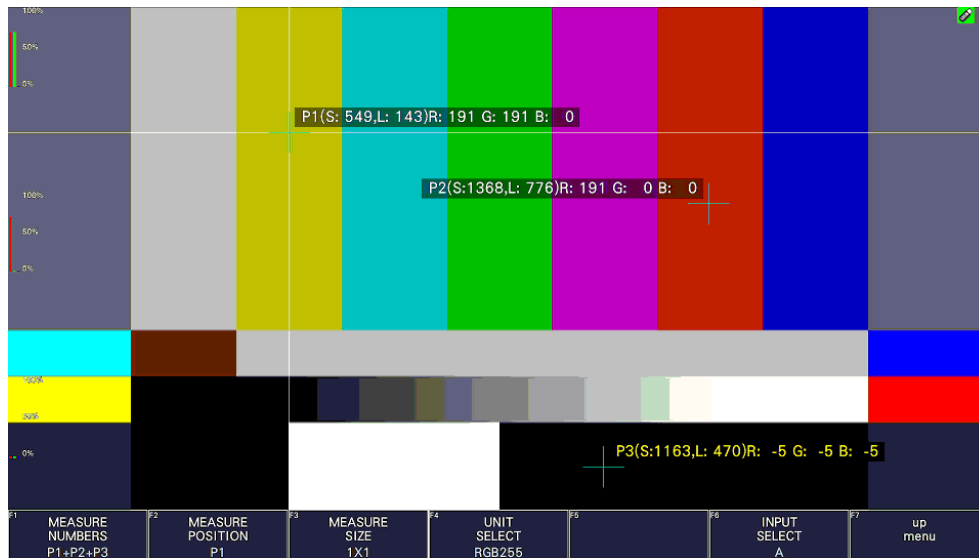

Figure 13-26 RGB255 display

- CV (CODE VALUE) Display, CV (CODE VALUE) (DEC) Display

When CV is selected, the SDI signal video data is displayed in hexadecimal.

When CA(DEC) is selected, the SDI signal video data is displayed in decimal.

When the input signal is YCbCr, the video is displayed in YCbCr, and when the input signal is RGB, the video is displayed in RGB.

You can select CV or CV(DEC) when MEAS SIZE is 1x1.

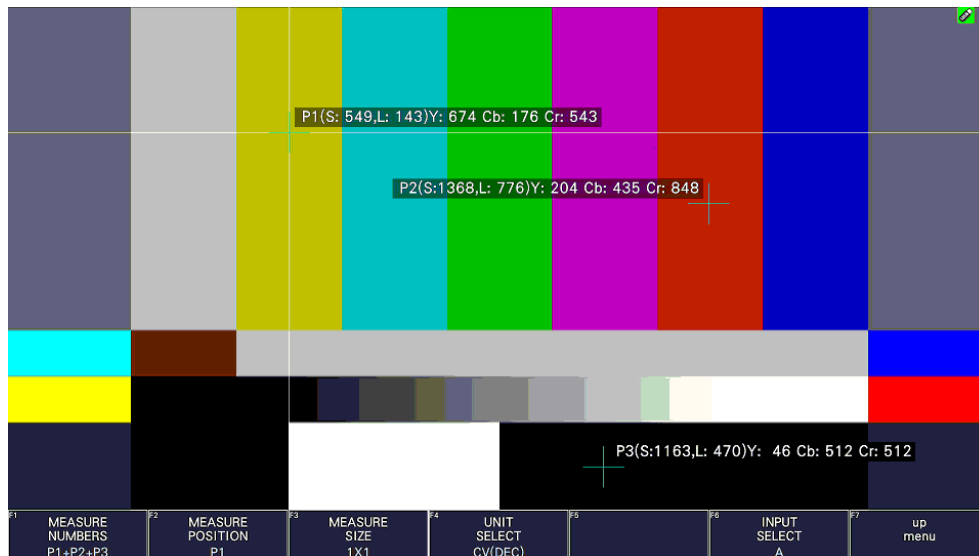

Figure 13-27 CODE VALUE DEC display

13.6.4 Selecting the Points to Display

You can set three points to measure: P1 to P3. To select the measured points that you want to display, follow the procedure below.

Procedure

PIC	→	F•2	CINELITE
→	F•2	f STOP SETUP	→ F•1 MEASURE NUMBERS: <u>P1</u> / P1+P2 / P1+P2+P3
→	F•2	%DISP SETUP	→ F•1 MEASURE NUMBERS: <u>P1</u> / P1+P2 / P1+P2+P3

Settings

P1:	P1 is displayed.
P1+P2:	P1 and P2 are displayed.
P1+P2+P3:	P1 to P3 are displayed.

13.6.5 Setting Measurement Points

Follow the procedure below to select which measurement point to set with the cursors, and then move the X cursor by using the H POS knob and the Y cursor by using the V POS knob. Press the H POS and V POS knobs at the same time to move the cursors to the center of the picture.

The cursors are not displayed if they are within the blanking interval. To display cursors that do not appear, move them within the screen.

The measurement point specified for f Stop and that specified for %DISPLAY are linked.

Procedure

PIC	→	F•2	CINELITE
→	F•2	f STOP SETUP	→ F•2 MEASURE POSITION: <u>P1</u> / P2 / P3
→	F•2	%DISP SETUP	→ F•2 MEASURE POSITION: <u>P1</u> / P2 / P3

13.6.6 Setting the Measurement Size

To select the measurement size, follow the procedure below. This setting is applied to P1 to P3 and REF.

The measurement size specified for f Stop and that specified for %DISPLAY are linked.

Procedure

PIC	→	F•2	CINELITE
→	F•2	f STOP SETUP	→ F•3 MEASURE SIZE: <u>1X1</u> / 3X3 / 9X9
→	F•2	%DISP SETUP	→ F•3 MEASURE SIZE: <u>1X1</u> / 3X3 / 9X9

Settings

1X1:	The single pixel at the intersection of the cursors is measured.
3X3:	The 3×3 area of pixels with its center at the intersection of the cursors is averaged and measured.
9X9:	The luminance of the 9×9 area of pixels centered on the pixel at the intersection of the cursors is averaged and measured.

13.6.7 Configuring User-Defined Correction Tables

The default gamma correction value when measuring f Stop levels is 0.45, but you can also use a user-defined gamma correction table that matches the gamma characteristics of the camera that you are using.

There are two types of user-defined correction tables. The first type consists of tables that are created using the instrument and is made up of the USER1 to USER3 tables. The second type consists of tables that have been created externally using a device such as a PC and is made up of the USER_A to USER_E tables. These tables are not deleted even if you initialize the instrument.

- Creating User-Defined Correction Tables Using the instrument

You can create and store up to three user-defined correction tables.

As an example, the following procedure shows how to create a user-defined correction table that matches a camera's gamma characteristics.

Set the camera's f Stop value to F5.6 beforehand, and put an 18 % gray chart in the area that you will film.

1. Adjust the lighting so that the displayed luminance level of the 18 % gray chart is 45.0 % (for example) on a camera whose f Stop value is set to F5.6.

For details, see section 13.6.3, "%DISPLAY Screen Description."

2. Press **F•7** up menu.
3. Press **F•1** CINELITE DISPLAY to select f Stop.
4. Press **F•2** f STOP SETUP.
5. Press **F•5** GAMMA and then **F•1** GAMMA SELECT to select USER1.

In this example, explanation will be given for USER1, but USER2 and USER3 can also be created in the same way.

6. Press **F•2** GAMMA CAL.

A user-defined correction table appears in the lower left of the screen, and the luminance level appears as a 10-bit value (0% is displayed as 64, and 100% is displayed as 940) close to the cursor.

This setting is available when **F•1** GAMMA SELECT is set to an option from USER1 to USER3.

13. PICTURE DISPLAY



Figure 13-28 User-defined correction table creation screen

7. Press **F•1** TABLE CLEAR.

All the values in the user-defined correction table that is currently being edited are initialized. Be sure to initialize the values first when you create a new user-defined correction table.

8. Press **F•1** CLEAR YES.

To cancel the initialization of the user-defined correction table, **F•3** CLEAR NO.

9. Place the cursors over the 18 % gray chart.

10. Press **F•5** CAL F, and select 5.6.

11. Press **F•4** CAL SET.

The luminance level when the camera f Stop value is F5.6 is input into Lev in the user-defined correction table. To delete a line of data, press **F•3** 1 DATA CLEAR.

12. Change **F•5** CAL F and the camera f Stop value together in the following order: 4.0, 2.8, 2.0, 8.0, 11.0, 16.0, and 22.0. **F•4** CAL SET each time you change the value to input the luminance level for each value.

Do not change the lighting or the position of the 18 % gray chart.

Also, make sure that the Lev value for f Stop values 22.0 to 2.0 increases linearly.

13. PICTURE DISPLAY

The REF value in the user-defined correction table is entered when you press **F•4** 18% REF-SET on the f Stop display.

For example, if you use the left-hand table shown below and press **F•4** 18% REF-SET when the luminance value at the intersection of the cursors is 416 (10-bit value), the f Stop value at that point (3.0) is displayed as the REF value.

[USER1] REF=0.0			[USER1] REF=3.0		
CAL_F	F	Lev	CAL_F	F	Lev
[22.0]	0.0,	152	[22.0]	0.0,	152
[16.0]	1.0,	240	[16.0]	1.0,	240
[11.0]	2.0,	328	[11.0]	2.0,	328
[8.0]	3.0,	416	[8.0]	3.0,	416
[5.6]	4.0,	504	[5.6]	4.0,	504
[4.0]	5.0,	592	[4.0]	5.0,	592
[2.8]	6.0,	680	[2.8]	6.0,	680
[2.0]	7.0,	768	[2.0]	7.0,	768

Figure 13-29 User-defined correction tables

When the above user-defined correction tables are used, f Stop values are indicated as shown below. The values between specified values are interpolated linearly.

When Lv = 152	f Stop = -3.0
When Lv = 240	f Stop = -2.0
When Lv = 328	f Stop = -1.0
When Lv = 416	f Stop = 0.0
When Lv = 504	f Stop = 1.0
When Lv = 592	f Stop = 2.0
When Lv = 680	f Stop = 3.0
When Lv = 768	f Stop = 4.0

13. PICTURE DISPLAY

- Loading a User-Defined Correction Table into the instrument

You can load up to five user-defined correction tables into the instrument.

To load a user-defined correction table into the instrument, follow the procedure below.

1. Create a user-defined correction table.

Example (TEST.CLT):

#####	Comment
NAME:SAMPLE_1	Keyword
TYPE:0	Keyword
#Input -7% 0	Comment
# 109% 4095	Comment
#Output 0% 0	Comment
# 1000% 65535	Comment
#Input Output	Comment
#####	Comment
0 0	Data
1 16	Data
2 32	Data
(Omitted)	
4093 65488	Data
4094 65504	Data
4095 65520	Data
# EOF	Comment

When you create a correction table, make sure that it conforms to the specifications listed below.

Overall File Specifications

Description:	ASCII text file
Extension:	.CLT
End-of-line character:	CR+LF
Number of lines:	5000 or less
Number of characters per line:	255 or less (including CR+LF)
File name length:	20 characters or less (excluding the extension)
Permitted file name characters:	Letters of the alphabet (A to Z; uppercase and lowercase), numerals (0 to 9), and underscores (_).

Comment

If you start a line with the number sign (#), the line is treated as a comment and does not affect operations.

You can put comments anywhere.

13. PICTURE DISPLAY

Keyword

Be sure to put the keyword lines before the data lines and to enter a keyword without anything preceding it at the beginning of each keyword line.

- NAME:** The instrument displays the eight characters that follow the separator (colon) as the name of the correction table. After the separator, enter the correction table name using letters of the alphabet (A to Z; uppercase and lowercase), numbers (0 to 9), and underscores (_). You can enter up to 10 characters.
- TYPE:** This is a code for identifying the file type. Enter a zero after the separator (colon).

Data

From the start of a line, enter the input value, a separator, and then the output value, in that order.

- Input value:** Enter values from 0 to 4095 (12 bits), increasing the value by one for each line.
A luminance level of 100 % is defined as $940 \text{ (10 bits)} \times 4 = 3760 \text{ (12 bits)}$.
A luminance level of 0 % is defined as $64 \text{ (10 bits)} \times 4 = 256 \text{ (12 bits)}$.
- Separator:** Enter a single tab code.
- Output value:** Enter a value from 0 to 65535 (16 bits).

2. Save the user-defined correction table to USB memory, and connect the USB memory to the instrument.

Save the correction table in the following directory.

```
├─ USB memory device
  └─ LV5600_USER or LV7600_USER
    └─ CLT
      └─ TEST.CLT (example)
```

3. Press PIC.
4. Press **F•2** CINELITE.
5. Press **F•1** CINELITE DISPLAY to select f Stop.
6. Press **F•2** f STOP SETUP.
7. Press **F•5** GAMMA and then **F•1** GAMMA SELECT to select USER_A.

In this example, a user-defined correction table is copied to USER_A, but user-defined correction tables can be copied to USER_B through USER_E in the same way.

8. Press **F•2** GAMMA FILE.
This setting is available when **F•1** GAMMA SELECT is set to an option from USER_A to USER_E.

9. Press **F•1** FILE LIST.

The file list screen appears. This setting appears when a USB memory device is connected.

To clear the table that has been copied to USER_A, press **F•2** TABLE CLEAR.

13. PICTURE DISPLAY

10. Turn the function dial (F•D) to select the copy source file from the USB memory device.

11. Press **F•3** FILE LOAD.

The user-defined correction table that you selected is copied from the USB memory to USER_A. The copy operation is complete when the file list screen disappears and the display returns to the measurement screen.

If a file has already been stored to USER_A, an overwrite confirmation prompt appears.

If you want to overwrite the current file, press **F•1** OVER WRITE YES. Otherwise, press **F•3** OVER WRITE NO.

After you have copied a user-defined correction table, you can select it by pressing **F•1** GAMMA SELECT in the CINELITE menu. A loaded correction table is displayed using the name determined by its NAME keyword.

13.6.8 Displaying Link Markers

To synchronize the markers on the vector screen and video signal waveform screen to measurement points P1 to P3 and REF that you specify on the CINELITE screen, follow the procedure below.

Synchronized markers can be displayed only when an f Stop screen, %DISPLAY screen, or %DISP & CINEZONE screen is shown in the same multi-screen display.

Markers cannot be displayed on the video signal waveform in the following situations.

- When SWEEP is set to V or H SWEEP is set to 2H in the video signal waveform menu
- When COLOR MATRIX in the video signal waveform menu is COMPOSIT

Marker display will not work properly when waveforms are being displayed using an external sync signal.

Procedure

PIC → **F•2** CINELITE → **F•4** CINELITE ADVANCE: ON / OFF

CINELITE ADVANCE = ON

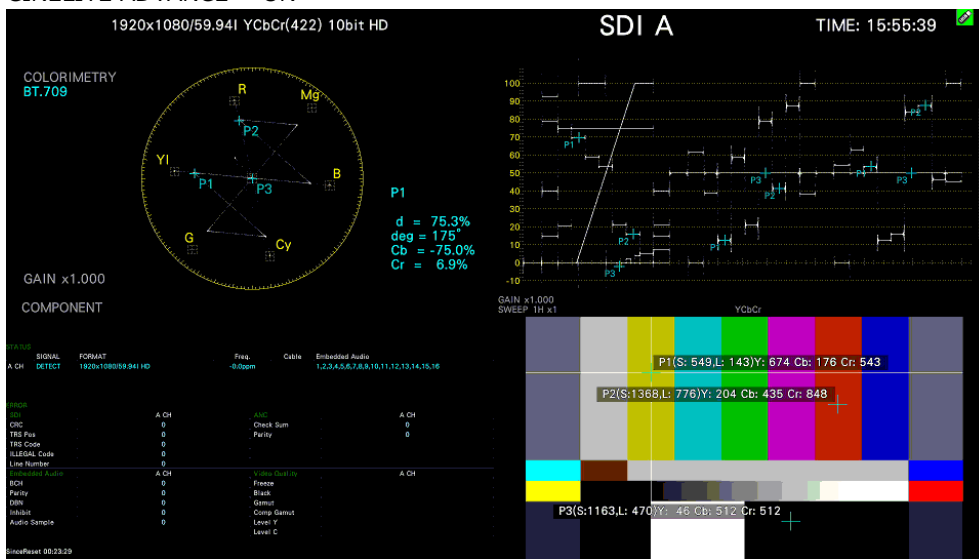

Figure 13-30 Displaying link markers

13.7 Configuring CINEZONE Settings

The CINEZONE display has a gradation (step) display mode, in which the picture luminance levels are converted into RGB colors and displayed and a search display mode, in which the specified luminance level is displayed using green.

To set either of these modes, on the picture menu, press **F•2** CINELITE → **F•1** CINELITE DISPLAY to select CINEZONE and then **F•2** CINEZONE SETUP.

[See also] CINEZONE SETUP → 13.5, “Configuring CINELITE Settings”

13.7.1 Gradation Display Mode

To display picture luminance levels through color gradation, follow the procedure below. In the gradation display mode, luminance levels are displayed using 1024 colors.

The picture is displayed such that luminance levels above **F•2** UPPER are displayed using white, and levels below **F•3** LOWER are displayed using black.

You can see what colors correspond to what luminance levels by looking at the scale on the right of the display.

F•2 UPPER can be changed with the V POS knob as well as the function dial (F•D).

F•3 LOWER can be changed with the H POS knob as well as the function dial (F•D).

If the difference between **F•2** UPPER and **F•3** LOWER is 1%, reducing **F•2** UPPER will also reduce **F•3** LOWER automatically to maintain the 1% difference. Likewise, increasing **F•3** LOWER will also increase **F•2** UPPER automatically to maintain the 1% difference.

Procedure

PIC → **F•2** CINELITE → **F•2** CINEZONE SETUP → **F•1** CINEZONE FORM and select GRADATE
 → **F•2** UPPER: -6.3 - 100.0 - 109.4
 → **F•3** LOWER: -7.3 - 0.0 - 108.4

Picture Screen

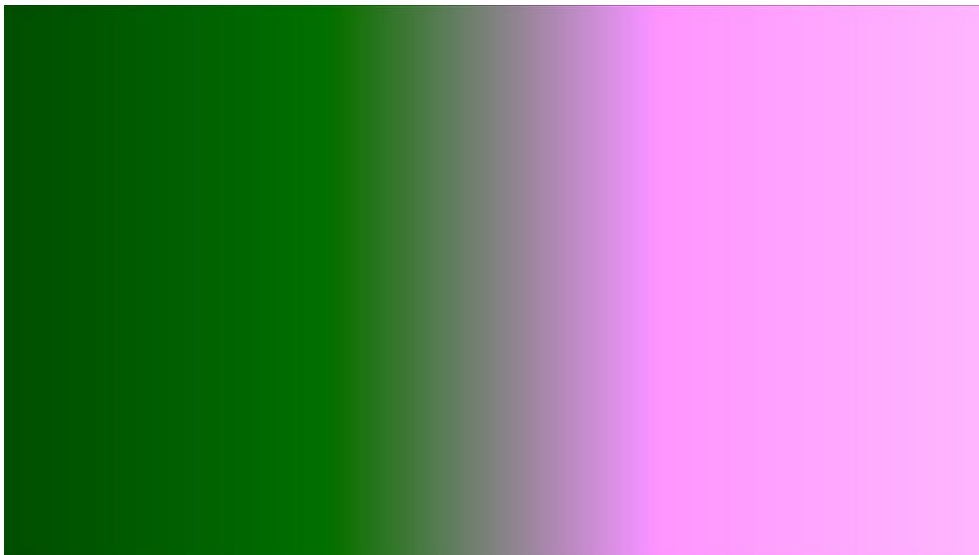

13. PICTURE DISPLAY

Gradation Display (0% = B, 50% = G, 100% = R)

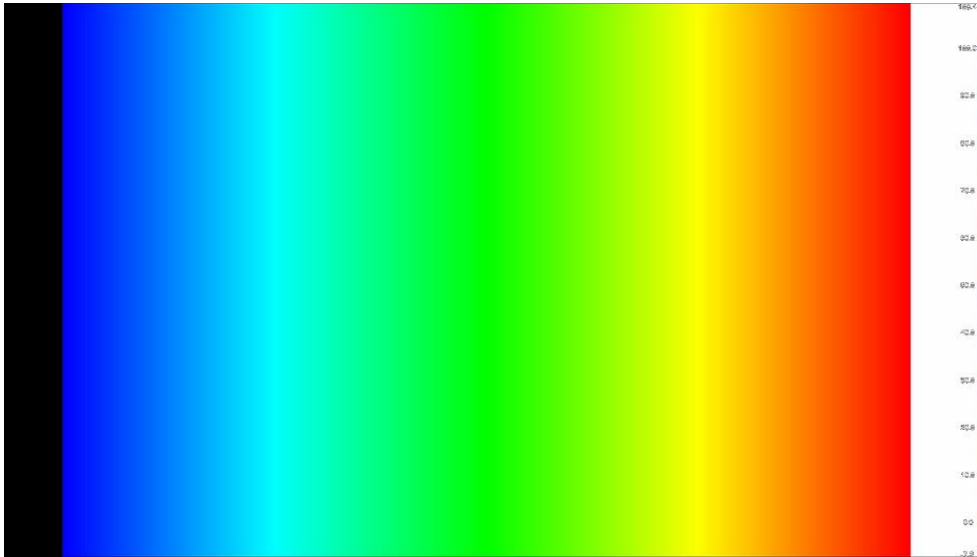

Figure 13-31 Gradation display

13.7.2 Step Display Mode

To display picture luminance levels in steps, follow the procedure below.

In the step display mode, luminance levels are divided into 10 % steps and assigned to 12 different colors. For information about **F•2** UPPER and **F•3** LOWER, see section 13.7.1, "Gradation Display Mode."

Procedure

PIC → **F•2** CINELITE → **F•2** CINEZONE SETUP → **F•1** CINEZONE FORM and select STEP
→ **F•2** UPPER
→ **F•3** LOWER

CINEZONE FORM = GRADATE

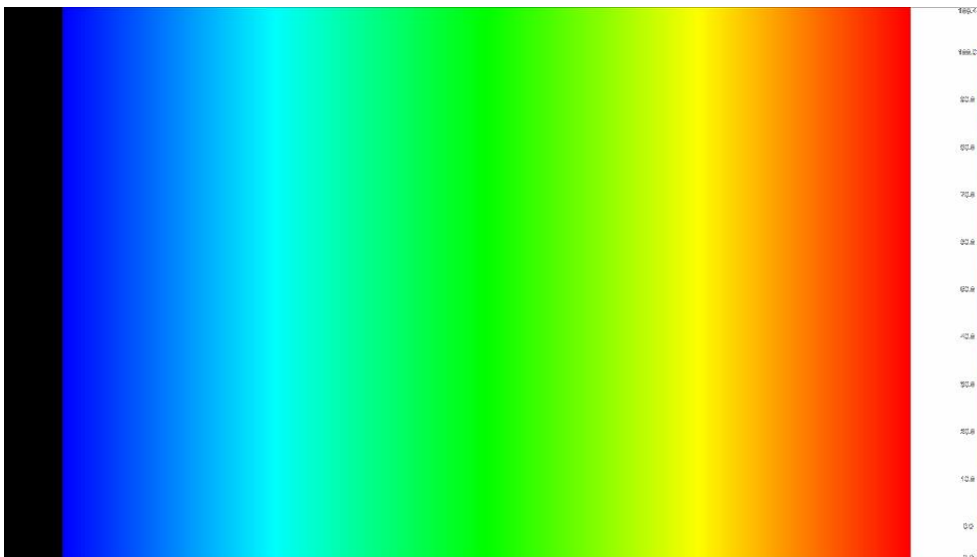

13. PICTURE DISPLAY

CINEZONE FORM = STEP

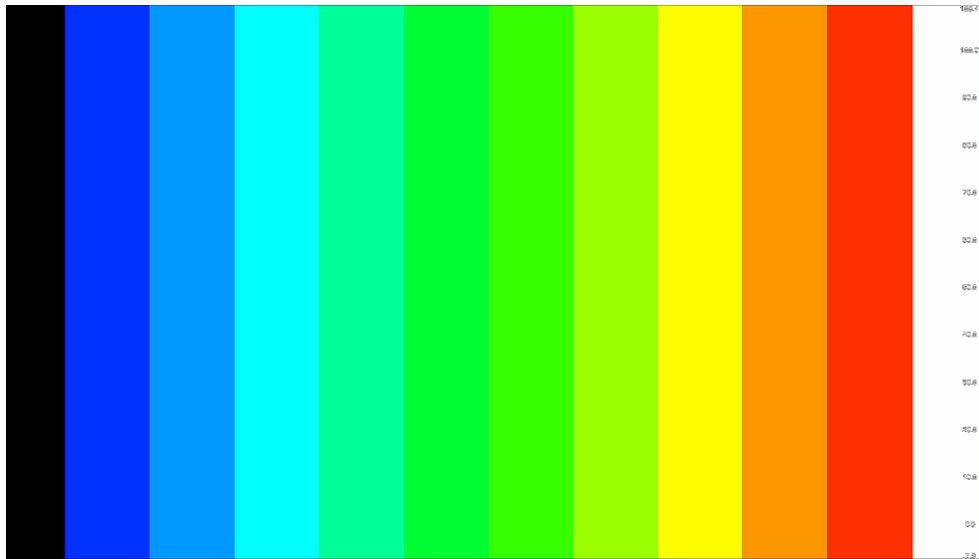

Figure 13-32 Step display

13. PICTURE DISPLAY

13.7.3 Search Display Mode

In the search display mode, the specified luminance level $\pm 0.5\%$ is displayed using green on an otherwise monochrome picture display.

The picture is displayed such that luminance levels above **F•2** UPPER are displayed using red, and levels below **F•3** LOWER are displayed using blue.

To set the level that is displayed using green, follow the procedure below.

F•4 LEVEL appears when **F•1** CINEZONE FORM is set to SEARCH.

For information about **F•2** UPPER and **F•3** LOWER, see section 13.7.1, "Gradation Display Mode."

Procedure

PIC → **F•2** CINELITE → **F•2** CINEZONE SETUP → **F•1** CINEZONE FORM and select SEARCH
→ **F•4** LEVEL: -7.3 - 50.0 - 109.4

CINEZONE FORM = SEARCH

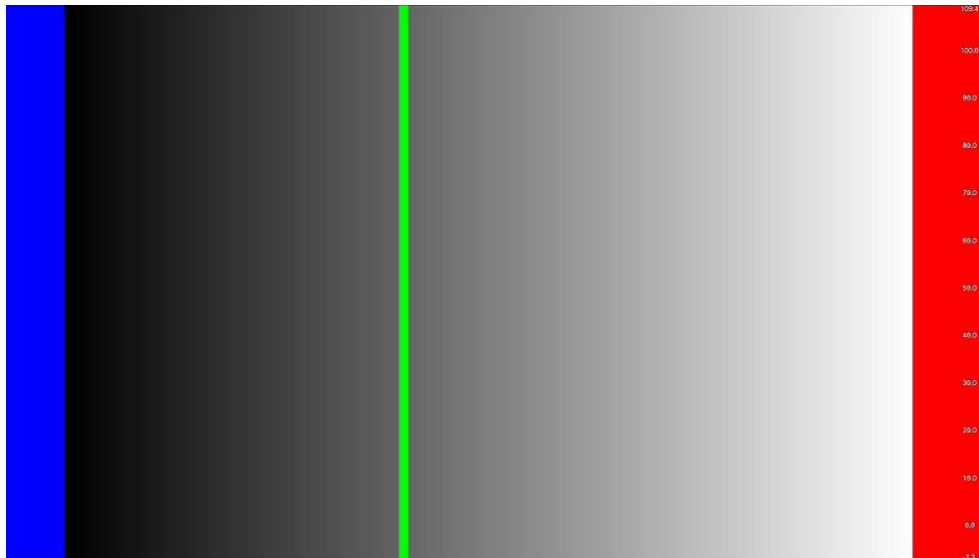

Figure 13-33 Search display

13.8 Configuring %DISPLAY & CINEZONE Settings

To display the %DISPLAY screen and the CINEZONE screen at the same time, follow the procedure below.

To configure the %DISPLAY screen settings, press **F•1** %DISP SETUP on the %DISP CINEZONE SETUP menu. See section 13.6.3, “%DISPLAY Screen Description,” 13.6.4, “Selecting the Points to Display,” 13.6.5, “Setting Measurement Points,” and 13.6.6, “Setting the Measurement Size.”

To configure the CINEZONE screen settings, press **F•2** CINEZONE SETUP on the %DISP CINEZONE SETUP menu. See section 13.7, “Configuring CINEZONE Settings.”

Procedure

-
- PIC → **F•2** CINELITE → **F•1** CINELITE DISPLAY and select %DISP & CINEZONE →
 - F•2** %DISP CINEZONE SETUP
 - **F•1** %DISP SETUP
 - **F•2** CINEZONE SETUP
-

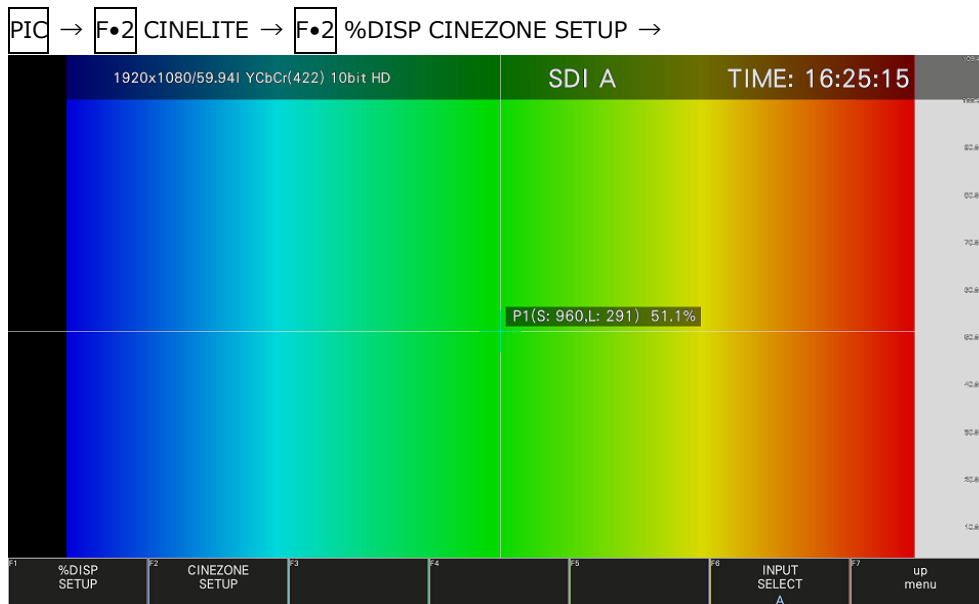

Figure 13-34 %DISPLAY & CINEZONE display

13.9 Focus Assist Display (SER25)

The focus assist display makes it easy to verify the focus by highlighting the image according to the amount of detected edges.

To configure the focus assist settings, press **F•4** FOCUS on the PIC menu. This menu item does not appear when PICTURE MODE is set to FULL FRM. [See also] SIZE → 13.1, "Selecting the Display Mode"

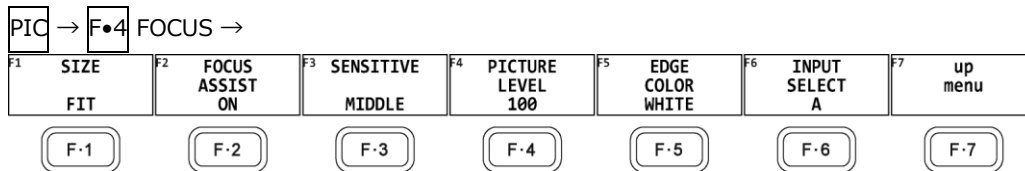

Figure 13-35 FOCUS menu



Figure 13-36 Focus assist display

13.9.1 Selecting the Display Mode

To select the picture display mode, follow the procedure below. For details, see section 13.1, "Selecting the Display Mode."

Procedure

PIC	→	F•4	FOCUS	→	F•1	PICTURE MODE: <u>FIT</u> / REAL / X2
-----	---	------------	-------	---	------------	--------------------------------------

13.9.2 Turning Focus Assist On and Off

To turn the focus assist display on and off, follow the procedure below.

Procedure

PIC	→	F•4	FOCUS	→	F•2	FOCUS ASSIST: ON / <u>OFF</u>
-----	---	------------	-------	---	------------	-------------------------------

13. PICTURE DISPLAY

13.9.3 Selecting the Detection Sensitivity

When **F•2** FOCUS ASSIST is set to ON, to select the edge detection sensitivity, follow the procedure below.

Procedure

PIC	→	F•4	FOCUS	→	F•3	SENSITIVE: LOW / <u>MIDDLE</u> / HIGH / V-HIGH / U-HIGH
-----	---	-----	-------	---	-----	---

13.9.4 Selecting the Luminance Level

When **F•2** FOCUS ASSIST is set to ON, to select the picture luminance level as a percentage, follow the procedure below.

Select OFF to hide the picture. Select EMBOSS to emboss the edges.

Procedure

PIC	→	F•4	FOCUS	→	F•4	PICTURE LEVEL: OFF / EMBOSS / 25 / 50 / 75 / <u>100</u>
-----	---	-----	-------	---	-----	---

PIC LEVEL = OFF

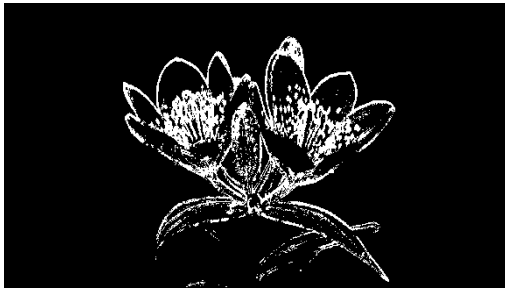

PIC LEVEL = EMBOSS



Figure 13-37 Selecting the luminance level

13.9.5 Selecting the Highlight Color

When **F•4** PIC LEVEL is 25, 50, 75, or 100, to select the edge display color, follow the procedure below.

Procedure

PIC	→	F•4	FOCUS	→	F•5	EDGE COLOR: <u>WHITE</u> / RED / GREEN / BLUE
-----	---	-----	-------	---	-----	---

13.10 Configuring the Line Selection Settings

To configure the line selection settings, press **F•5** LINE SELECT on the PIC menu. This menu item does not appear when PICTURE MODE is set to a value other than FIT. [See also] PICTURE MODE → 13.1, "Selecting the Display Mode"

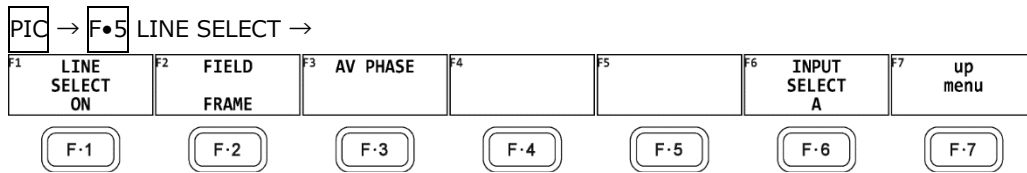

Figure 13-38 LINE SELECT menu

13.10.1 Turning Line Selection On and Off

To display a marker at the selected line, follow the procedure below. You can use the function dial (F•D) to select a line. The number of the selected line appears in the upper left of the screen.

Changing this setting will also change the video-signal-waveform-display and vector-display line selection settings.

Procedure

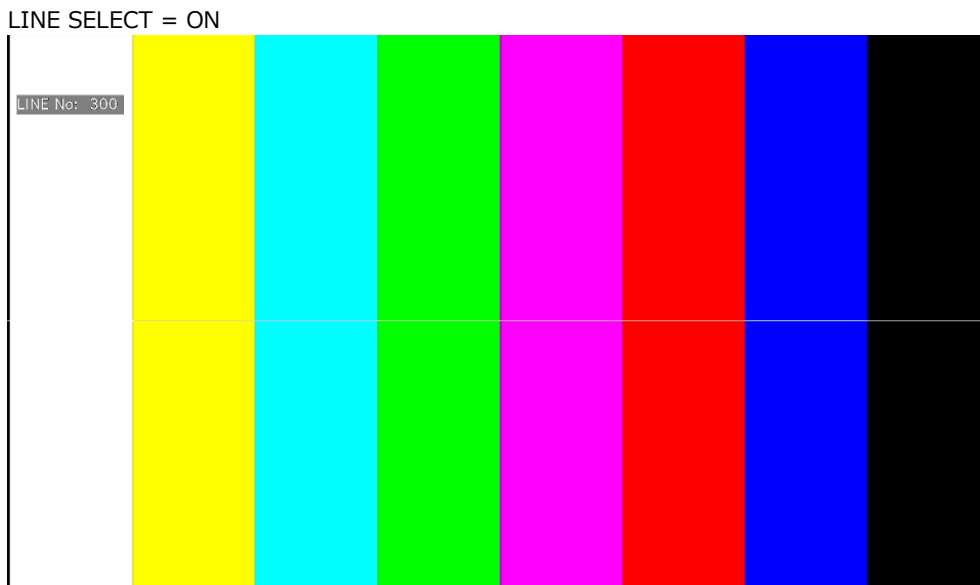
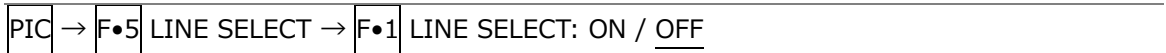

Figure 13-39 Turning line selection on and off

13. PICTURE DISPLAY

13.10.2 Setting the Line Selection Range

When **F•1** LINE SELECT is set to ON and the input signal format is interlaced or segmented frame, to set the line selection range, follow the procedure below.

Changing this setting will also change the selected line on the video-signal-waveform, vector, and status (data dump) displays.

Procedure

PIC → **F•5** LINE SELECT → **F•2** FIELD: FIELD1 / FIELD2 / FRAME

Settings

FIELD1: A line from field 1 can be selected. (Example: 1 to 563)

FIELD2: A line from field 2 can be selected. (Example: 564 to 1125)

FRAME: All lines can be selected. (Example: 1 to 1125)

13.10.3 Setting the Lip Sync Measurement Range (SER03)

To set the lip sync measurement range, press **F•3** AV PHASE on the LINE SELCT menu.

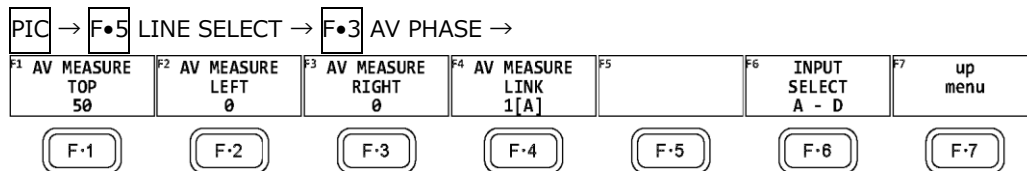

Figure 13-40 AV PHASE menu

To set the lip sync measurement range, follow the procedure below. Markers are displayed at the specified lines.

You can also set these using AV PHASE SETUP of the STATUS menu, but here you can set them while viewing the picture. For details on the settings, section 16.7.3, "Setting the Measurement Range."

Procedure

PIC → **F•5** LINE SEL → **F•3** AV PHASE
 → **F•1** AV MEASURE TOP: 0 - 50 - 100
 → **F•2** AV MEASURE LEFT: 0 - 99
 → **F•3** AV MEASURE RIGHT: 0 - 99
 → **F•4** AV MEASURE LINK: 1[A] / 2[B] / 3[C] / 4[D]

13.11 Video noise measurement (SER30)

The video noise measurement measures the noise included in the Y, G, B, or R signal of the SDI signal applied to the instrument and displays it on the picture.

When the SER30 is installed, **F.5** LINE SELECT on the PIC menu changes to **F.5** LINE SELECT / NOISE. From here, configure the video noise measurement.

This section uses a 10 step pattern for the explanation.

PIC → **F.5** LINE SELECT / NOISE → **F.4** NOISE SETUP →
 PIC → **F.5** LINE SELECT / NOISE → **F.5** NOISE STOP/START

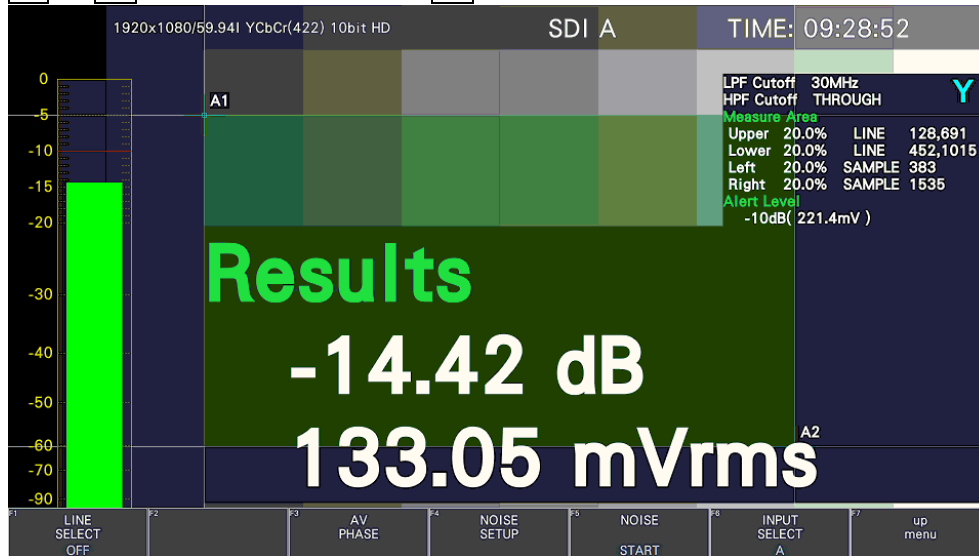

Figure 13-41 Video noise measurement

13.11.1 Turning the Video Noise Measurement On and Off

To turn the video noise measurement on and off, follow the procedure shown below.

Procedure

PIC → **F.5** LINE SELECT / NOISE → **F.5** NOISE: STOP / START

Settings

- STOP: Indicates that the video noise measurement is off. Press **F.5** to turn on the video noise measurement.
- START: Indicates that the video noise measurement is on. Press **F.5** to turn off the video noise measurement.

13. PICTURE DISPLAY

13.11.2 Configuring the Measurement Window

To display a window for measuring video noise on the picture display, follow the procedure below.

Set what percentage of the active picture area will be the window using cursors A1 and A2. The green area defined by the diagonally opposite cursors A1 and A2 becomes the measurement window.

Set this with the video noise measurement turned on.

Procedure

```
PIC → F•5 LINE SELECT / NOISE → F•4 NOISE SETUP
→ F•1 CURSOR CH: A1 / A2 / TRACK / OFF
```

Settings

A1:	Select cursor A1 for setting the measurement window. Use the V POS and H POS knobs to adjust the position of the cursor.
A2:	Select cursor A2 for setting the measurement window. Use the V POS and H POS knobs to adjust the position of the cursor.
TRACK:	Moves the measurement window. Use the V POS and H POS knobs to adjust the positions of cursors A1 and A2 simultaneously.
OFF:	Turns off the cursor A1 and A2 display.

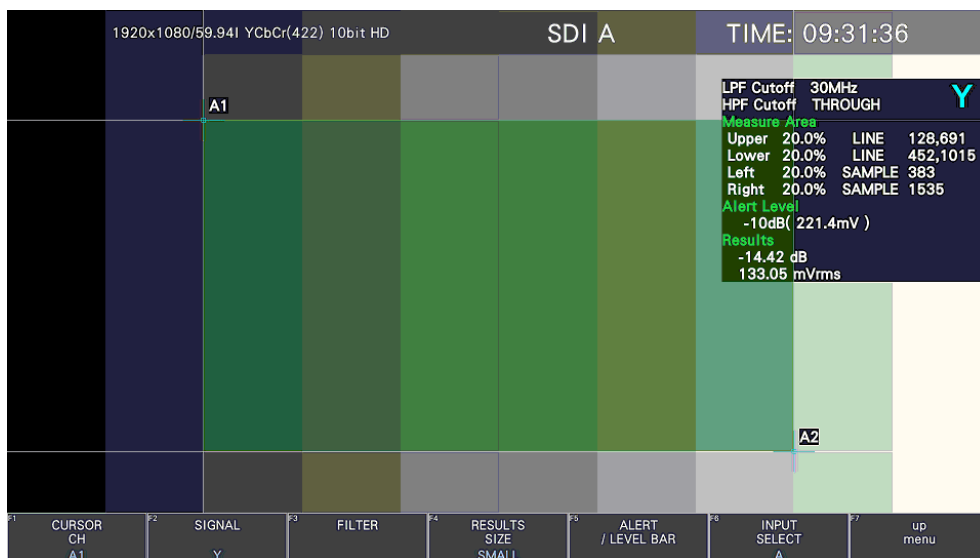

Figure 13-42 Measurement window

- * Set the measurement window in an area where the average video level is uniform. If you include dark areas in the video caused by the effect of the lens or areas where the video signal of the object is not flat, accurate video noise measurement may not be possible.
- * There may be cases in which accurate video noise measurement is not possible due to overshooting, undershooting, or ringing occurring in the rising or falling edges of the waveform depending on the input video signal. If this happens, set the measurement window a few percent inside of the rising or falling section.

13. PICTURE DISPLAY

13.11.3 Selecting the Measurement Signal

To select the signal to measure, follow the procedure below.

Procedure

PIC	→	F•5	LINE SELECT / NOISE	→	F•4	NOISE SETUP	→	F•2	SIGNAL: <u>Y</u> / G / B / R
-----	---	-----	---------------------	---	-----	-------------	---	-----	------------------------------

13.11.4 Selecting the Filter

To set the cutoff frequencies of the low-pass filter and high-pass filter, follow the procedure below.

Procedure

PIC	→	F•5	LINE SELECT / NOISE	→	F•4	NOISE SETUP	→	F•3	FILTER
→	F•1	LPF:	5.5MHz / 4.4MHz / 3.6MHz / 2.7MHz / 1.4MHz / 0.7MHz / THROUGH						
→	F•1	LPF:	30MHz / 24MHz / 20MHz / 15MHz / 7.5MHz / 3.7MHz / THROUGH						
→	F•1	LPF:	60MHz / 48MHz / 40MHz / 30MHz / 15MHz / 7.5MHz / THROUGH						
→	F•1	LPF:	120MHz / 96MHz / 80MHz / 60MHz / 30MHz / 15MHz / THROUGH						
→	F•1	LPF:	240MHz / 192MHz / 160MHz / 120MHz / 60MHz / 30MHz / THROUGH						
→	F•1	LPF:	0.404 / 0.323 / 0.269 / 0.202 / 0.101 / 0.0505 / THROUGH (*1)						
→	F•2	HPF:	OFF / ON						

*1 When the input format cannot be detected, a normalized frequency is displayed.

* The cutoff frequencies of the low-pass filter and high-pass filter vary depending on the input format. For details, see section 3.3.31, "Video Noise Measurement (SER30)."

13.11.5 Selecting the Measurement Result Display Size

To select the measurement result display size, follow the procedure below.

Procedure

PIC	→	F•5	LINE SELECT / NOISE	→	F•4	NOISE SETUP
→	F•4	RESULTS SIZE:	<u>SMALL</u> / LARGE			

RESULTS SIZE = SMALL

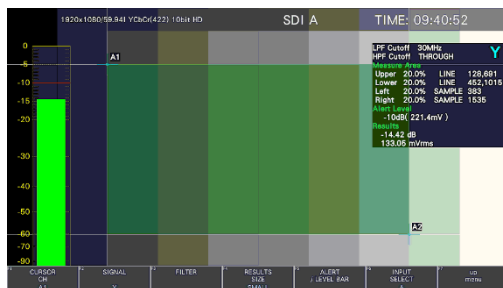

RESULTS SIZE = LARGE

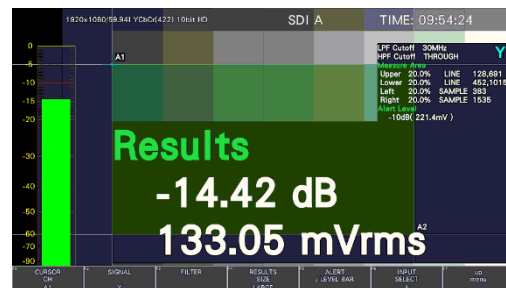

Figure 13-43 Selecting the measurement result display size

13. PICTURE DISPLAY

13.11.6 Turning the Alarm Function On and Off

To turn the alarm function on and off, follow the procedure below.

When set to on, **F•2** ALARM LEVEL appears, and you can set the threshold of the alarm function.

Procedure

PIC → **F•5** LINE SELECT / NOISE → **F•4** NOISE SETUP
 → **F•5** ALARM / LEVEL BAR → **F•1** ALARM UNIT: OFF / ON

13.11.7 Setting the Threshold of the Alarm Function

When the alarm function is on, to set the threshold of the alarm function, follow the procedure below.

When the measurement result is greater than or equal to the specified threshold, the measurement result display turns red.

Procedure

PIC → **F•5** LINE SELECT / NOISE → **F•4** NOISE SETUP
 → **F•5** ALARM / LEVEL BAR → **F•2** ALARM LEVEL: -80dB (0.1mV) - 0dB (700.0mV)

When the measurement result is less than the threshold

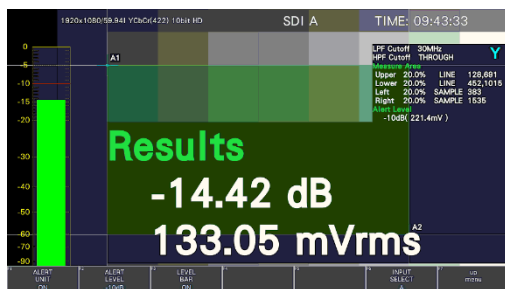

When the measurement result is greater than or equal to the threshold

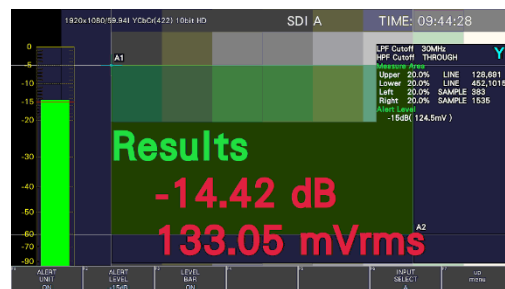

Figure 13-44 Alarm display

13. PICTURE DISPLAY

13.11.8 Turning the Level Bar Display On and Off

To turn the level bar display on and off on the left side of the screen, follow the procedure below.

When the alarm function is on, the specified threshold is displayed with a red line.

Procedure

PIC → F.5 LINE SELECT / NOISE → F.4 NOISE SETUP
→ F.5 ALARM / LEVEL BAR → F.3 LEVEL BAR: ON / OFF

When the level bar display is on

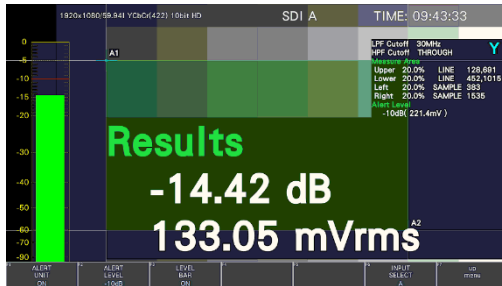

When the level bar display is off

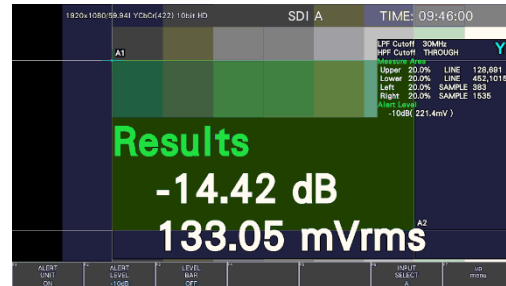

Figure 13-45 Turning the level bar display on and off

14. HDR DISPLAY (SER23)

HDR signals can be measured by installing SER23. HDR signal measurement supports all formats except for SD or XYZ.

To measure HDR signals, use **[SYS]** → **[F•1]** SIGNAL IN OUT → HDR tab to select the HDR signal standard for each display channel. Also set SYSTEM GAMMA on or off and other settings.

[See also] HDR tab → 7.1.9, “Configuring the HDR Settings (SER23)”

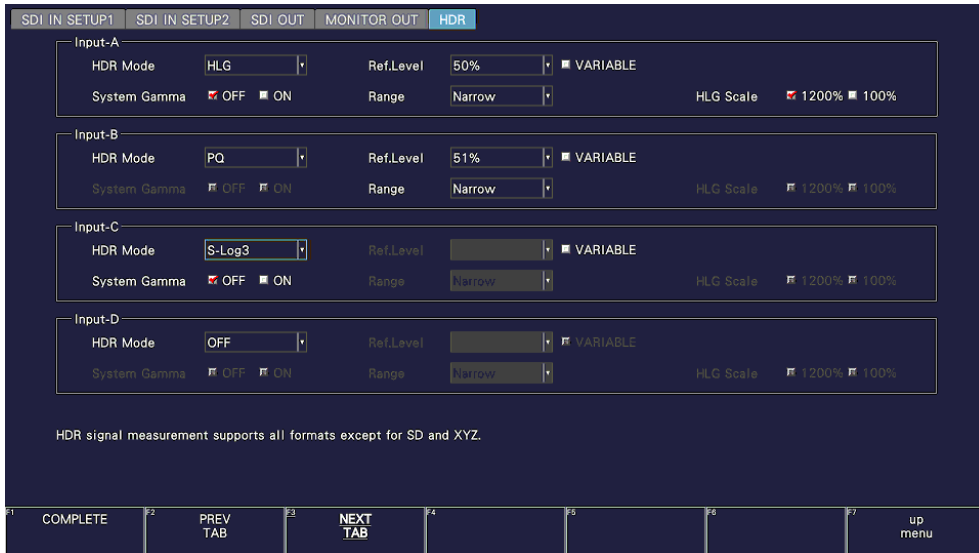

Figure 14-1 HDR tab

14. HDR DISPLAY (SER23)

- Scale Unit and Range

The scale unit and range used on HDR signal measurements are as follows depending on the settings on the HDR tab.

HDR Mode	EI	System Gamma	Range	HLG Scale	Scale	
OFF	-	-	-	-	None	
HLG	-	OFF	Narrow	1200%	SDI code value: 64 to 940 is displayed as 0 to 1200%.	
				100%	SDI code value: 64 to 940 is displayed as 0 to 100%.	
			Full	1200%	SDI code value: 0 to 1023 is displayed as 0 to 1200%. (*1)	
				100%	SDI code value: 0 to 1023 is displayed as 0 to 100%. (*1)	
		ON	Narrow	1200%	SDI code value: 64 to 940 is displayed as 0 to 1000 Nits.	
				100%	SDI code value: 64 to 940 is displayed as 0 to 1000 Nits.	
			Full	1200%	SDI code value: 0 to 1023 is displayed as 0 to 1000 Nits. (*1)	
				100%	SDI code value: 0 to 1023 is displayed as 0 to 1000 Nits. (*1)	
PQ	-	-	Narrow	-	SDI code value: 64 to 940 is displayed as 0 to 10000 Nits.	
			Full	-	SDI code value: 0 to 1023 is displayed as 0 to 10000 Nits. (*1)	
S-Log3	-	OFF	-	-	SDI code value: 95 to 940 is displayed as 0 to 2055%.	
		ON	-	-	SDI code value: 95 to 940 is displayed as 0 to 3000 Nits.	
C-Log	-	-	-	-	Displays the percentage with the SDI code value 128 assumed to 0% and 614 assumed to be 100%	
Log-C	200	-	-	-	Displays the percentage with the SDI code value 95 assumed to 0.39% and 853 assumed to be 83%	
					400	Displays the percentage with the SDI code value 95 assumed to 0.39% and 917 assumed to be 90%
					800	Displays the percentage with the SDI code value 95 assumed to 0.39% and 976 assumed to be 95%
					1600	Displays the percentage with the SDI code value 95 assumed to 0.39% and 1022 assumed to be 94%
PayloadID UnSpec:S-Log3	Operates in OFF (SDR-TV), HLG, or PQ mode according to the payload ID information. When the payload ID information is Unspecified, the instrument operates in S-Log3 mode.					
PayloadID UnSpec:C-Log	Operates in OFF (SDR-TV), HLG, or PQ mode according to the payload ID information. When the payload ID information is Unspecified, the instrument operates in C-Log mode.					
PayloadID UnSpec:Log-C	Operates in OFF (SDR-TV), HLG, or PQ mode according to the payload ID information. When the payload ID information is Unspecified, the instrument operates in Log-C mode.					

*1 SDI code values: 0 to 1023 take on values from 4 to 1019.

14. HDR DISPLAY (SER23)

14.1 Video Signal Waveform Display

On the video signal waveform display, scales and cursors for HDR signals can be displayed.

14.1.1 Scale Display

During HDR measurement, a scale corresponding to the HDR signal is displayed on the right side of the video signal waveform.

Note that the scale on the right side is not displayed when COLOR MATRIX is set to COMPOSITE.

The scale on the right side varies as follows depending on the settings on the HDR tab.

HDR Mode	EI	System Gamma	HLG Scale	Scale
HLG	-	OFF	1200%	0 to 1200 [%]
			100%	0 to 100 [%]
		ON	1200%	0 to 1000 [Nits]
			100%	0 to 1000 [Nits]
PQ	-	-	-	0 to 10000 [Nits]
S-Log3	-	OFF	-	0 to 2055 [%]
		ON	-	0 to 3000 [Nits]
C-Log	-	-	-	-2.7 to 546 [%]
Log-C	200	-	-	0.2 to 100 [%]
		-	-	0.3 to 100 [%]
		-	-	0.3 to 100 [%]
		-	-	0.4 to 100 [%]
PayloadID UnSpec:S-Log3	Operates in OFF (SDR-TV), HLG, or PQ mode according to the payload ID information. When the payload ID information is Unspecified, the instrument operates in S-Log3 mode.			
PayloadID UnSpec:C-Log	Operates in OFF (SDR-TV), HLG, or PQ mode according to the payload ID information. When the payload ID information is Unspecified, the instrument operates in C-Log mode.			
PayloadID UnSpec:Log-C	Operates in OFF (SDR-TV), HLG, or PQ mode according to the payload ID information. When the payload ID information is Unspecified, the instrument operates in Log-C mode.			

HDR Mode = HLG, SYSTEM GAMMA = OFF, Range = Narrow, HLG Scale = 1200%

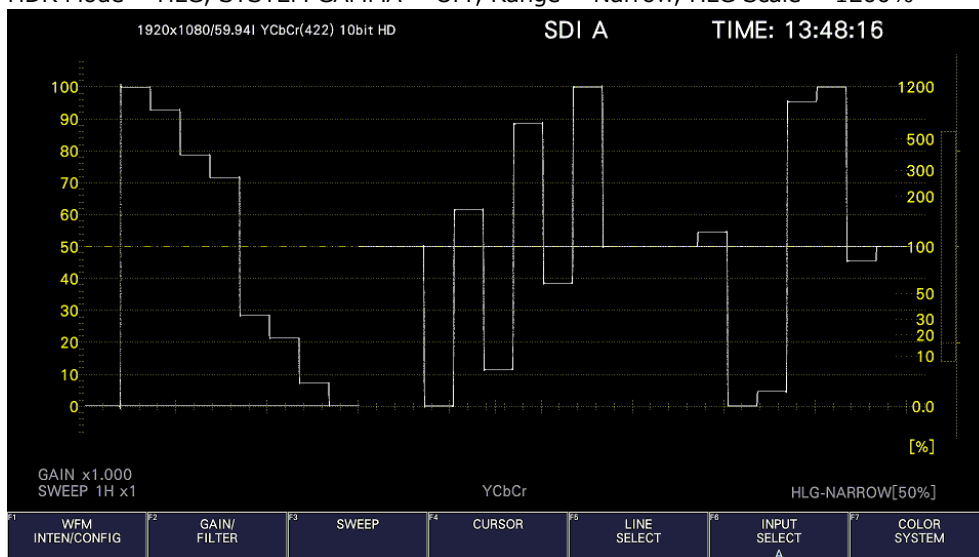

14. HDR DISPLAY (SER23)

HDR Mode = HLG, SYSTEM GAMMA = OFF, Range = Narrow, HLG Scale = 100%

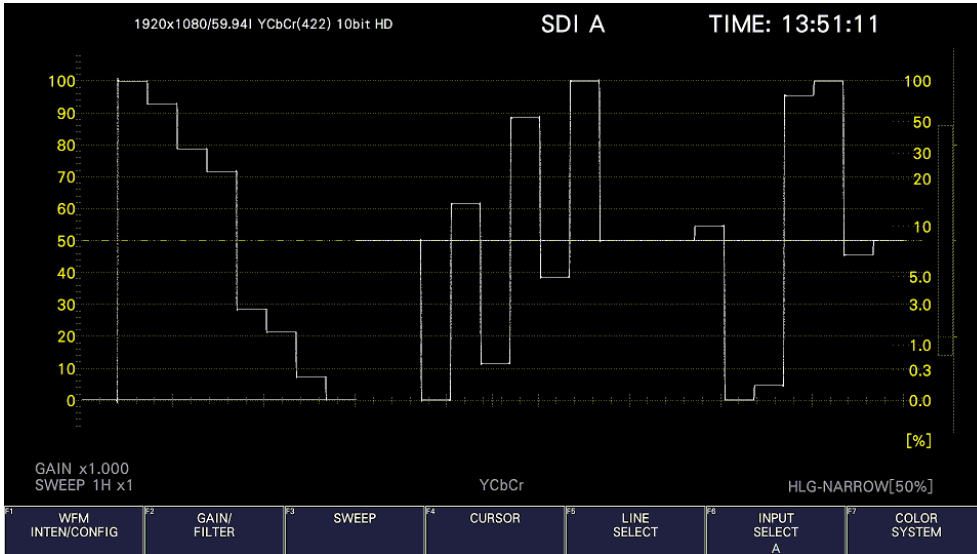

HDR Mode = HLG, SYSTEM GAMMA = OFF, Range = Full, HLG Scale = 1200%

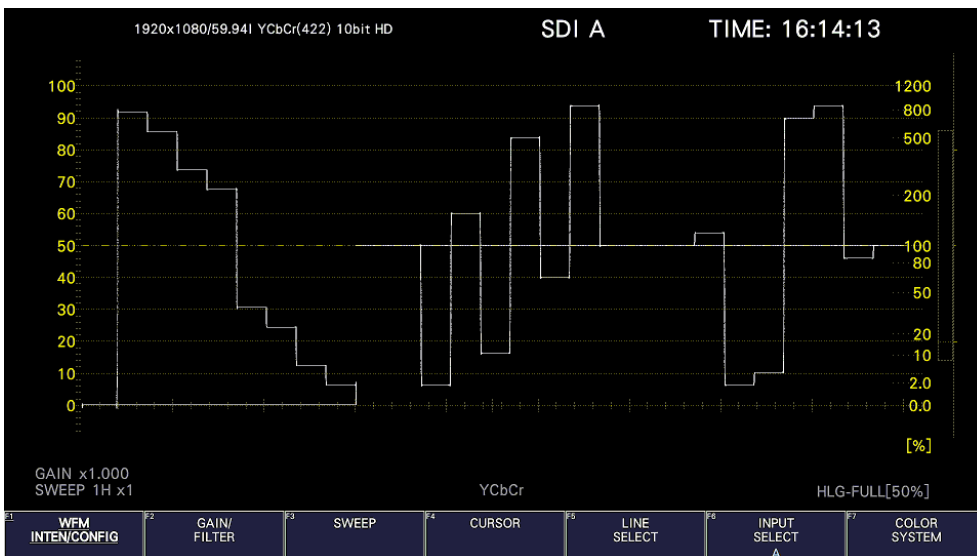

HDR Mode = HLG, SYSTEM GAMMA = OFF, Range = Full, HLG Scale = 100%

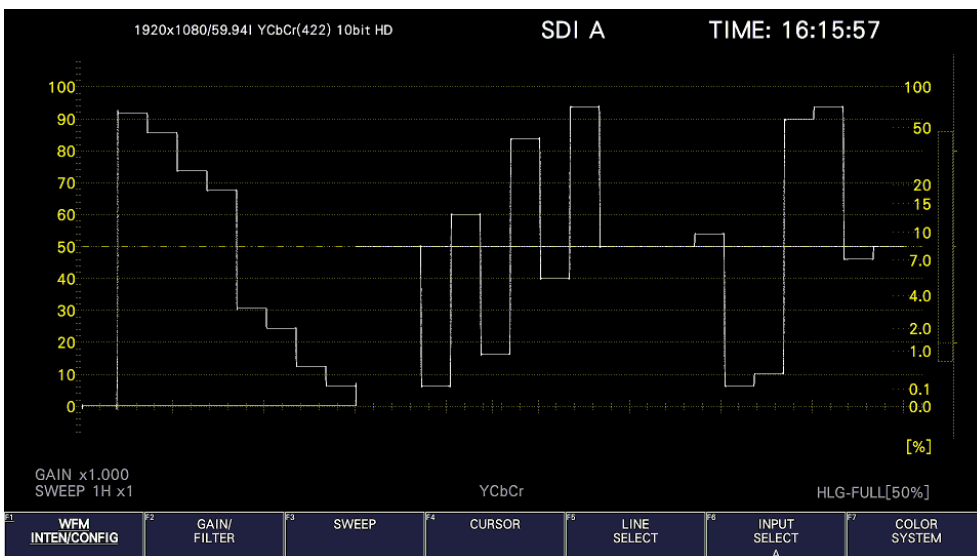

14. HDR DISPLAY (SER23)

HDR Mode = HLG, SYSTEM GAMMA = ON, Range = Narrow, HLG Scale = 1200% or 100%

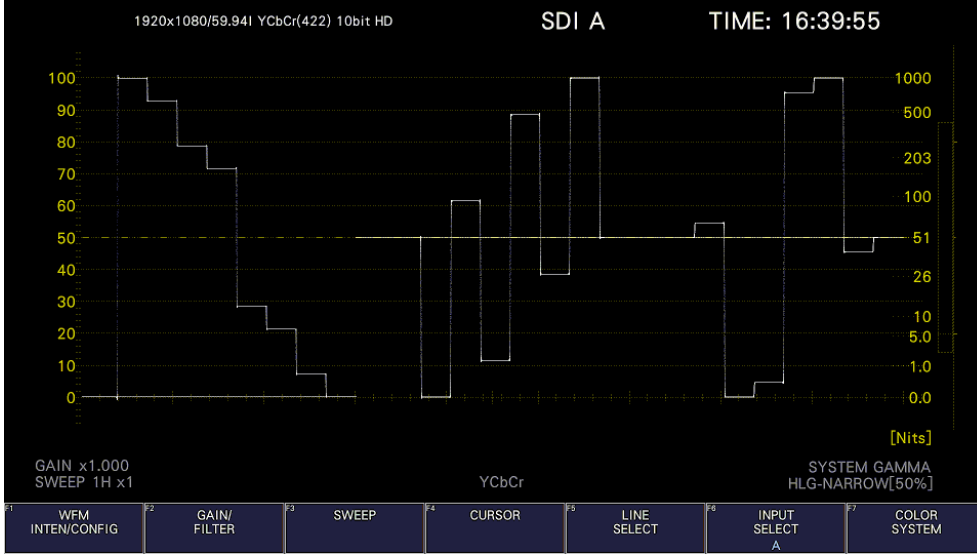

HDR Mode = HLG, SYSTEM GAMMA = ON, Range = Full, HLG Scale = 1200% or 100%

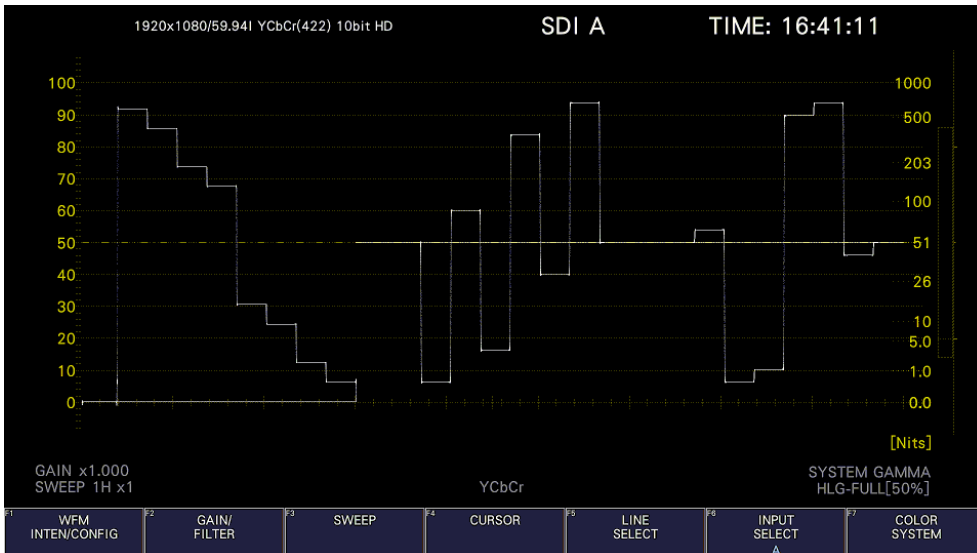

HDR Mode = PQ, Range = Narrow

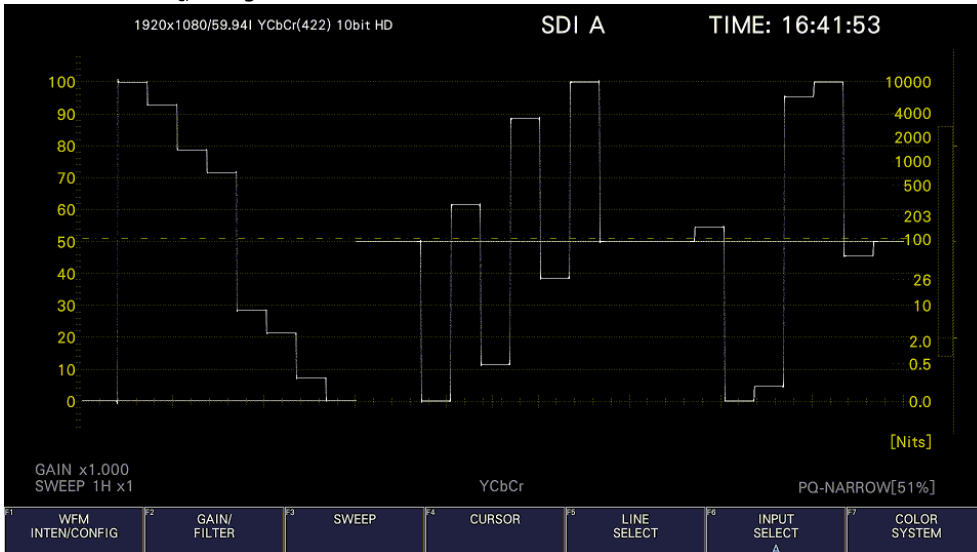

14. HDR DISPLAY (SER23)

HDR Mode = PQ, Range = Full

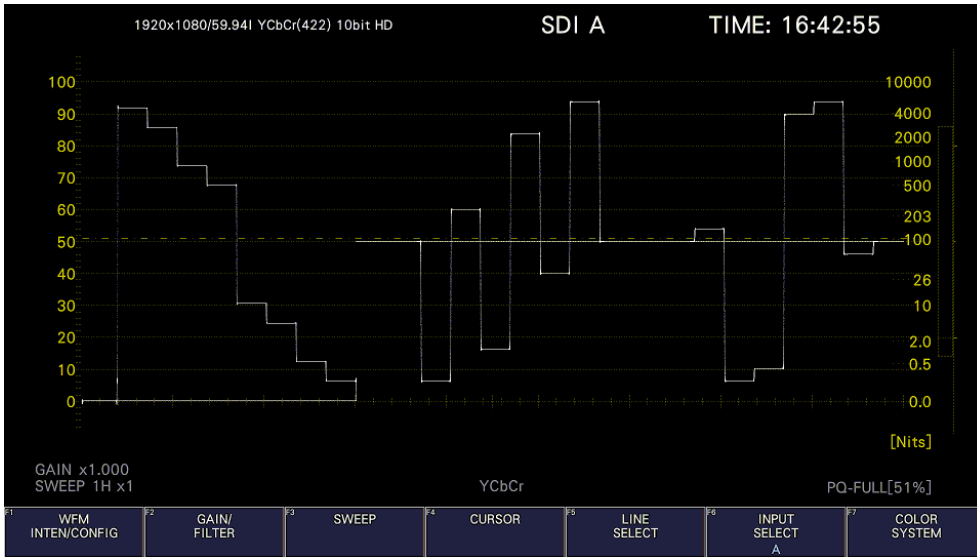

HDR Mode = S-Log3, SYSTEM GAMMA = OFF

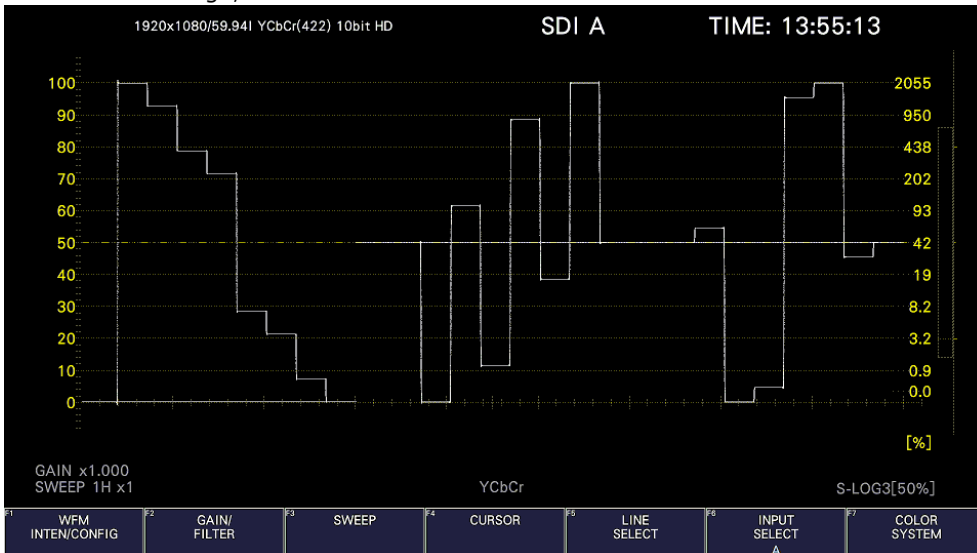

HDR Mode = S-Log3, SYSTEM GAMMA = ON

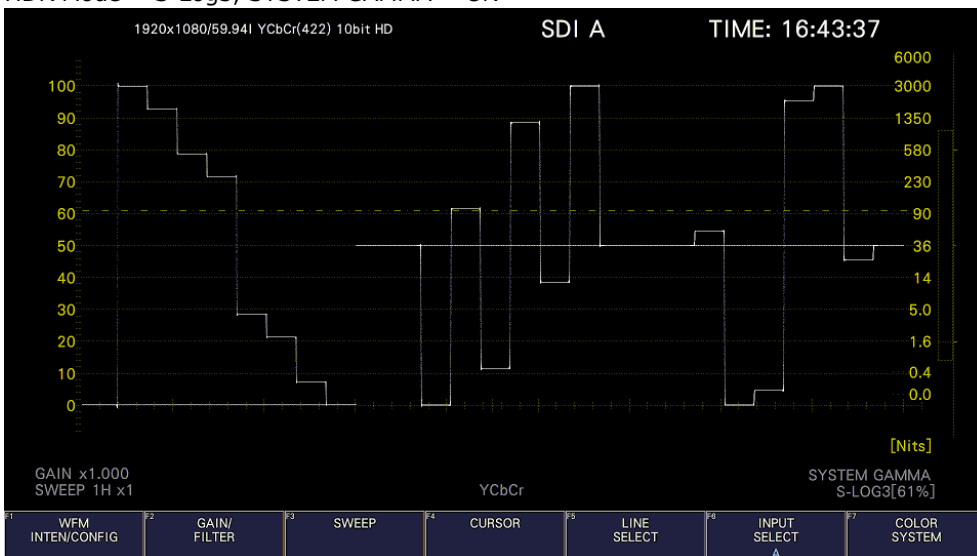

14. HDR DISPLAY (SER23)

HDR Mode = C-Log

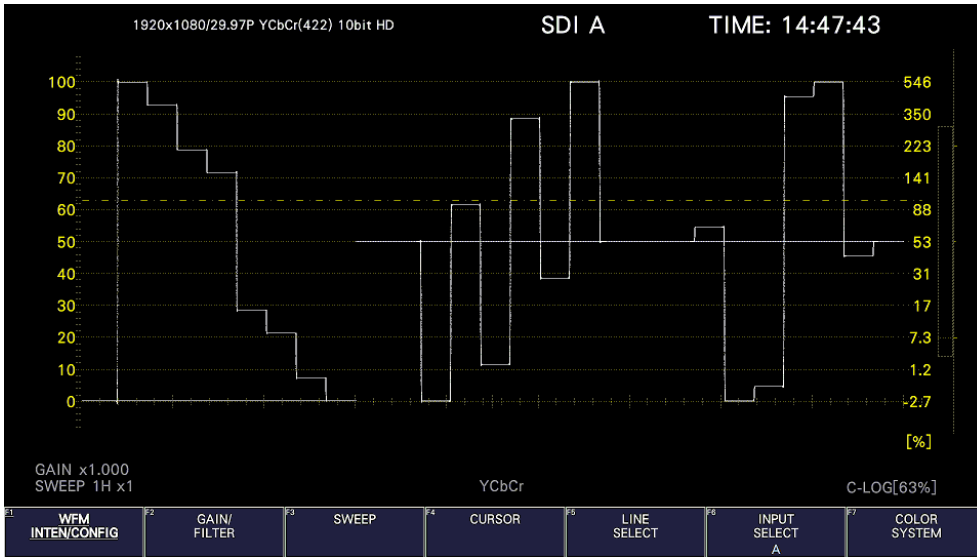

HDR Mode = Log-C, EI = 200

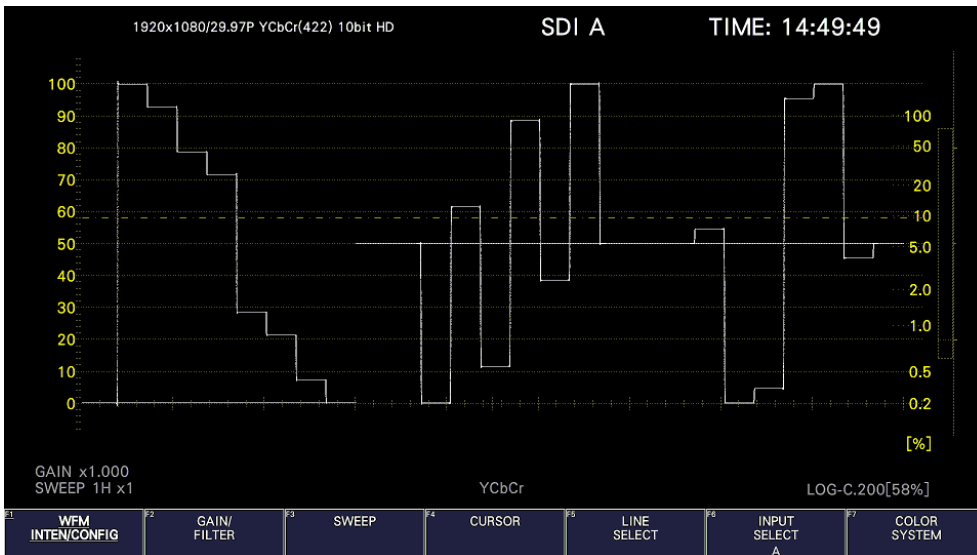

HDR Mode = Log-C, EI = 400

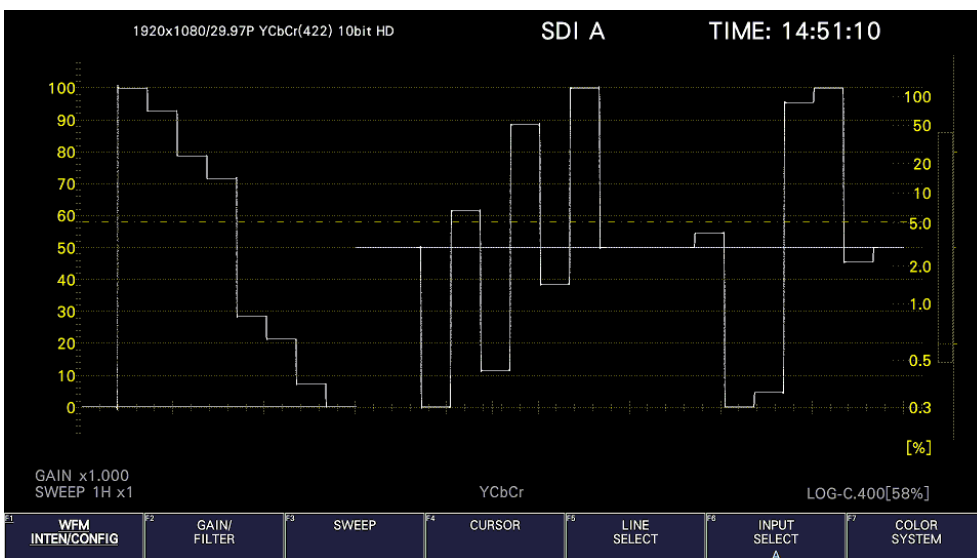

14. HDR DISPLAY (SER23)

HDR Mode = Log-C, EI = 800

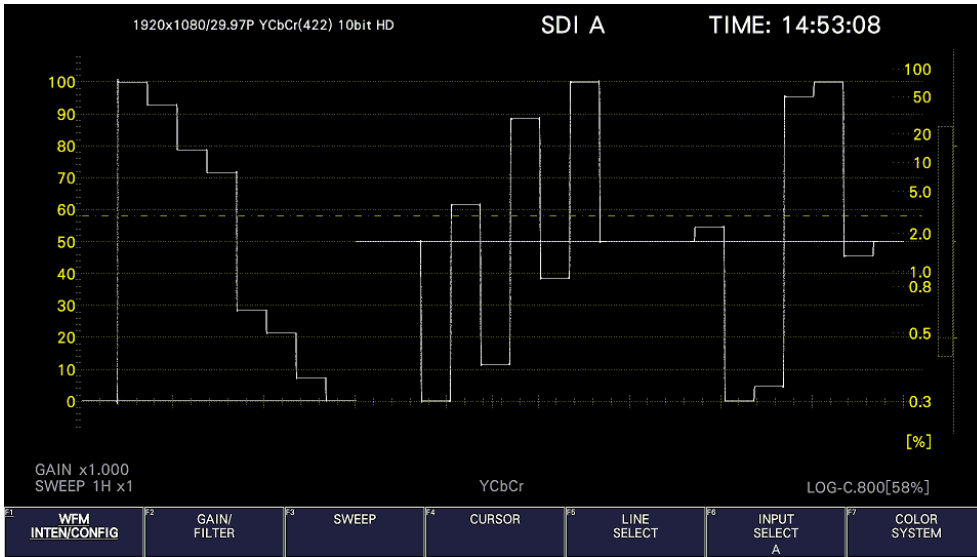

HDR Mode = Log-C, EI = 1600

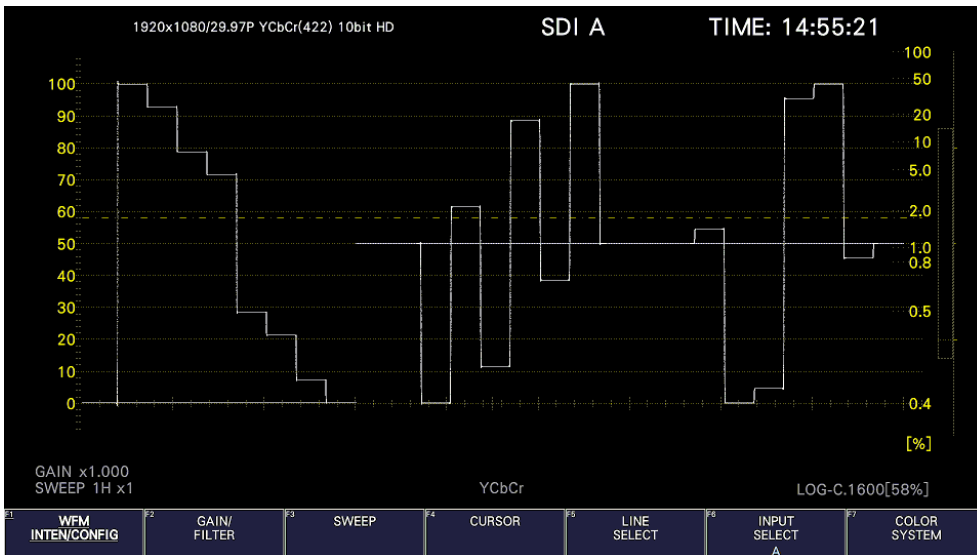

Figure 14-2 Scale display

14. HDR DISPLAY (SER23)

14.1.2 Selecting the Scale Display

During HDR measurement, to select the scale display, follow the procedure below.

Procedure

WFM → F•1 WFM INTEN/CONFIG → F•5 WFM SCALE → F•3 SCALE SETTING → F•3 SCALE
 DISPLAY: OFF / MAIN / HDR / BOTH

Settings

OFF: The scale display is turned off.
 MAIN: The normal scale is displayed.
 HDR: An HDR scale for HDR signals is displayed.
 BOTH: The normal scale and an HDR scale for HDR signals are displayed.

SCALE DISPLAY = OFF

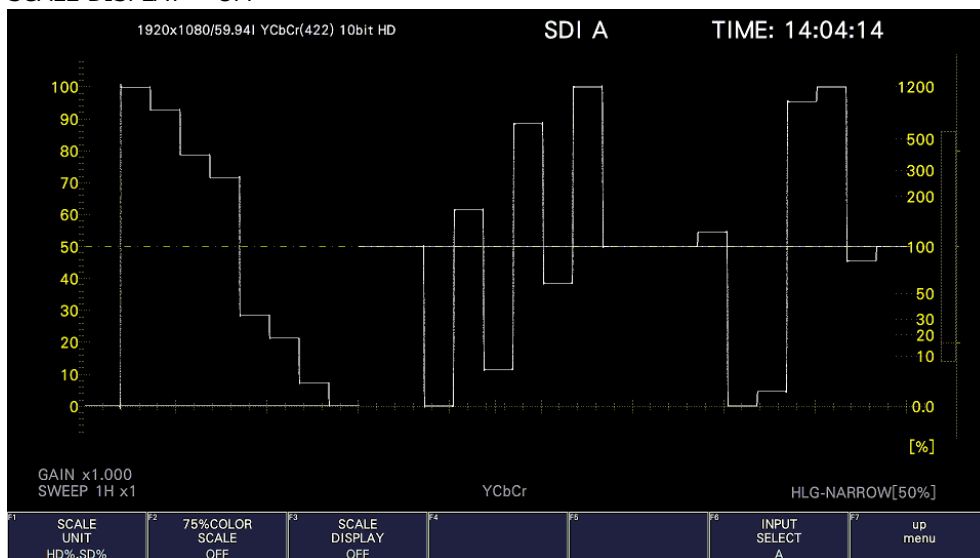

SCALE DISPLAY = MAIN

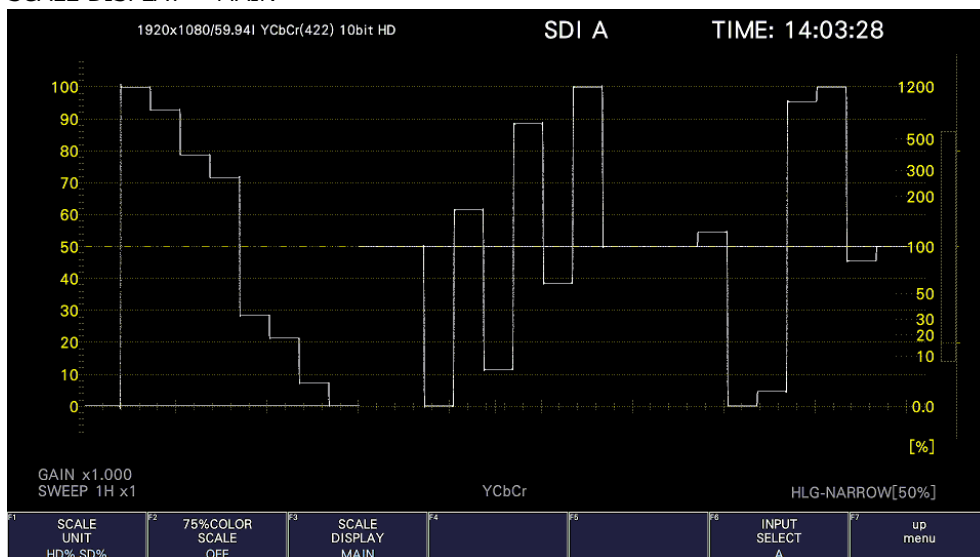

14. HDR DISPLAY (SER23)

SCALE DISPLAY = HDR

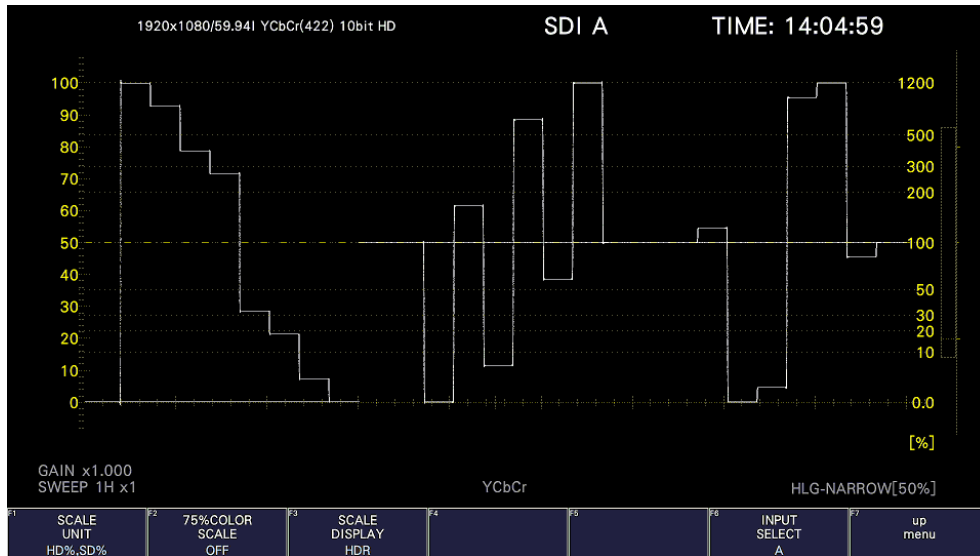

SCALE DISPLAY = BOTH

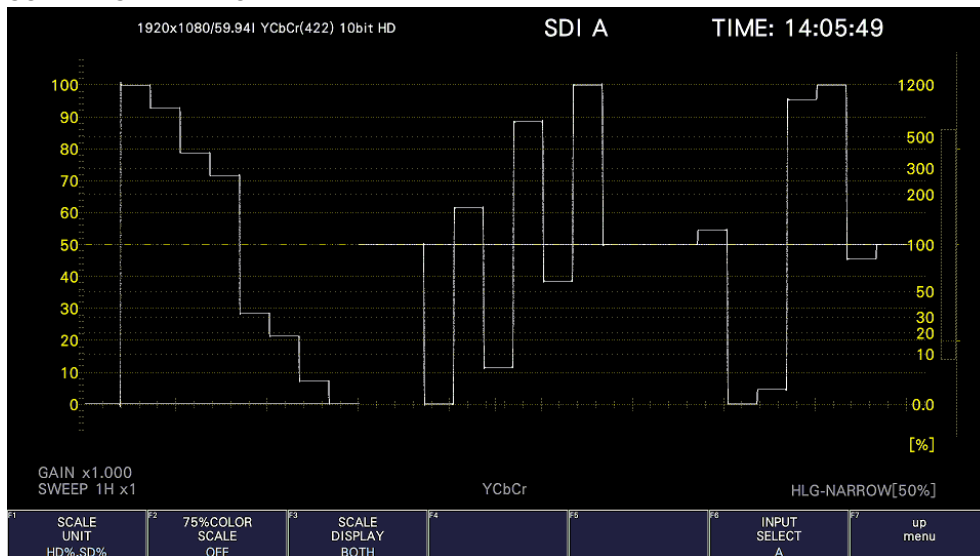

Figure 14-3 Selecting the scale display

14.1.3 Setting the Reference Level

When VARIABLE is selected on the HDR tab for HDR measurement, to set the reference level, follow the procedure below.

This setting is shared with REF [%] of the CINEZONE display.

The Ref.Level on the HDR tab is the default value.

[See also] VARIABLE → 7.1.9, "Configuring the HDR Settings (SER23)"

Procedure

WFM → F•1 WFM INTEN/CONFIG → F•5 WFM SCALE → F•3 SCALE SETTING
 → F•4 REF. LEVEL [%]: 0.0 – Ref.Level - 100

14. HDR DISPLAY (SER23)

14.1.4 Cursor Display

During cursor measurement, to display measured values for HDR signals, follow the procedure below.

The unit of measurement is % when on the HDR tab, HDR Mode is HLG or S-Log3 and SYSTEM GAMMA is OFF and Nits when HDR Mode is HLG or S-Log3 and SYSTEM GAMMA is ON or when HDR Mode is PQ.

Procedure

WFM	→	F•4	CURSOR	→	F•3	Y UNIT: HDR
-----	---	-----	--------	---	-----	-------------

Y UNIT = HDR

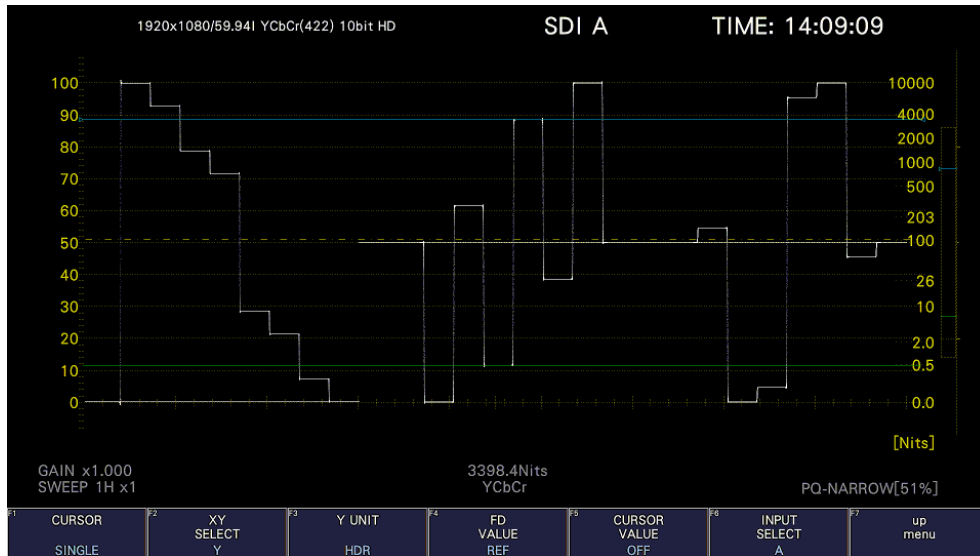

Figure 14-4 Cursor display (HDR Mode = PQ)

14. HDR DISPLAY (SER23)

14.2 Vector Display

On the vector display, HDR mode and a histogram for HDR signals can be displayed.

14.2.1 HDR Mode Display

When VECTOR DISPLAY is set to VECTOR, the HDR mode selected in HDR Mode in the system settings is displayed in cyan in HDR at the top left of the screen.

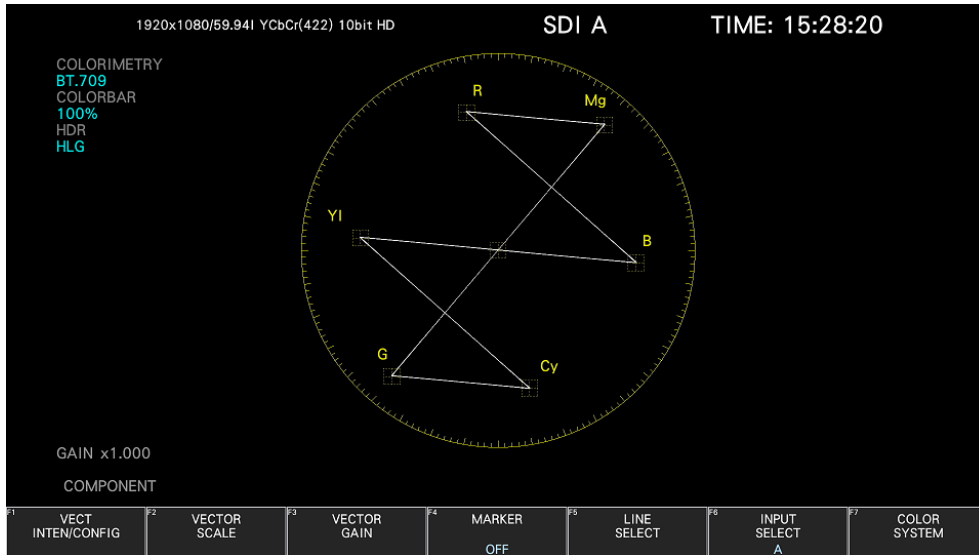

Figure 14-5 HDR mode display

14. HDR DISPLAY (SER23)

14.2.2 Histogram Display

During histogram display, to select the horizontal scale, follow the procedure below.

Procedure

VECT	→	F•2	HISTOGRAM SCALE: % / HDR
------	---	-----	--------------------------

The scale for HDR varies as follows depending on the settings on the HDR tab.

HDR Mode	EI	System Gamma	HLG Scale	Scale
HLG	-	OFF	1200%	0 to 1200 [%]
	-		100%	0 to 100 [%]
	-	ON	1200%	0 to 1000 [Nits]
	-		100%	0 to 1000 [Nits]
PQ	-	-	-	0 to 10000 [Nits]
S-Log3	-	OFF	-	0 to 2055 [%]
	-	ON	-	0 to 3000 [Nits]
C-Log	-	-	-	-2.7 to 546 [%]
Log-C	200	-	-	0.33 to 83 [%]
	400	-	-	0.36 to 90 [%]
	800	-	-	0.38 to 72 [%]
	1600	-	-	0.38 to 43 [%]
PayloadID UnSpec:S-Log3	Operates in OFF (SDR-TV), HLG, or PQ mode according to the payload ID information. When the payload ID information is Unspecified, the instrument operates in S-Log3 mode.			
PayloadID UnSpec:C-Log	Operates in OFF (SDR-TV), HLG, or PQ mode according to the payload ID information. When the payload ID information is Unspecified, the instrument operates in C-Log mode.			
PayloadID UnSpec:Log-C	Operates in OFF (SDR-TV), HLG, or PQ mode according to the payload ID information. When the payload ID information is Unspecified, the instrument operates in Log-C mode.			

HISTOGRAM SCALE = HDR

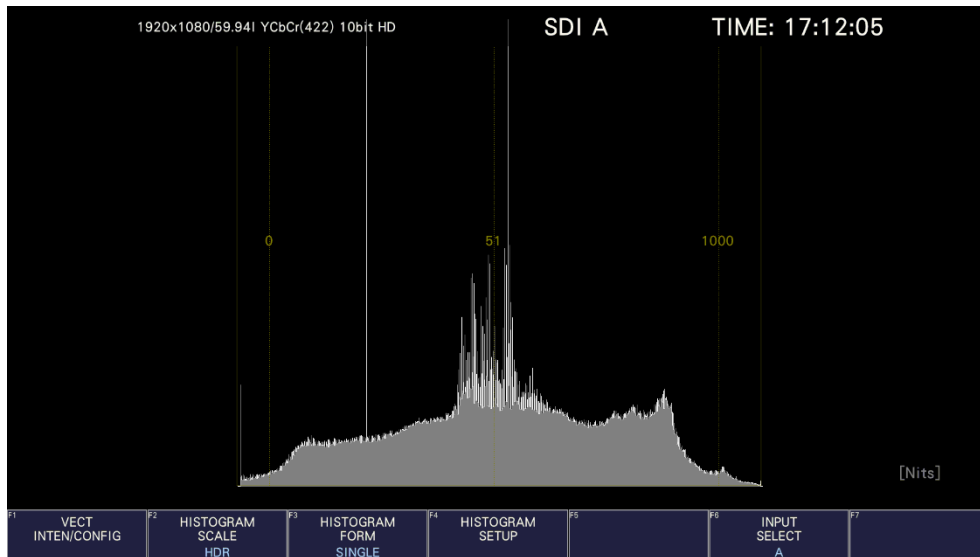

Figure 14-6 Histogram display (HDR Mode = PQ)

14.3 Picture Screen

The picture display can show CINELITE, CINEZONE, MAX FALL, and MAX CLL for HDR signals. During HDR measurement **F•2** CINELITE of the PIC menu changes to **F•2** CINELITE/HDR. You can use this to show CINELITE, CINEZONE, MAX FALL, and MAX CLL.

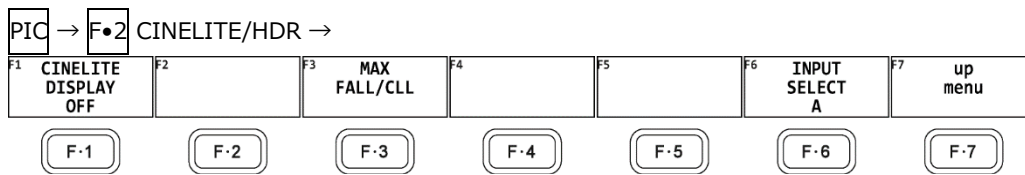

Figure 14-7 CINELITE/HDR menu

14.3.1 CINELITE and CINEZONE Displays

To switch to the CINELITE or CINEZONE display, follow the procedure below.

Procedure

PIC → **F•2** CINELITE/HDR → **F•1** CINELITE DISPLAY: OFF / %DISPLAY / CINEZONE
/ %DISP & CINEZONE

Settings

OFF:	CINELITE and CINEZONE is not displayed.
%DISPLAY:	The %DISPLAY screen is displayed. This option cannot be selected in 3G-B DS or when PICTURE MODE is set to a value other than FIT.
CINEZONE:	The CINEZONE screen is displayed. This option cannot be selected in 3G-B DS.
%DISP & CINEZONE:	The %DISPLAY screen and the CINEZONE screen are displayed at the same time. This option cannot be selected in 3G-B DS. When PICTURE MODE is set to a value other than FIT, the %DISPLAY screen will not be displayed even if you select %DISP & CINEZONE.

* For black-and-white images, the brightness indicated by %DISPLAY and the brightness indicated by CINEZONE are the same, but for color images there is a slight difference depending on the size of the color component. This difference is especially large for test signals with large color components such as color bars.

14. HDR DISPLAY (SER23)

CINELITE DISPLAY = OFF



CINELITE DISPLAY = %DISPLAY

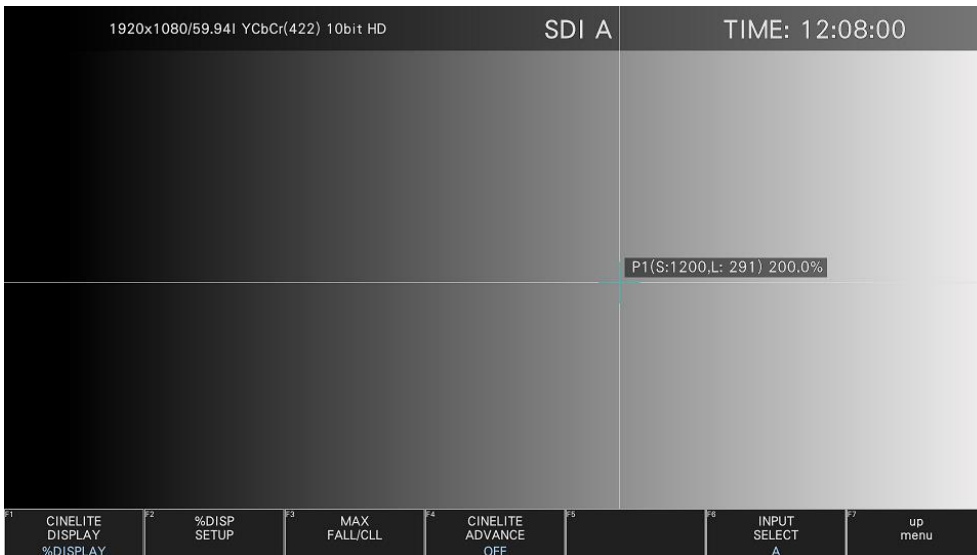

14. HDR DISPLAY (SER23)

CINELITE DISPLAY = CINEZONE

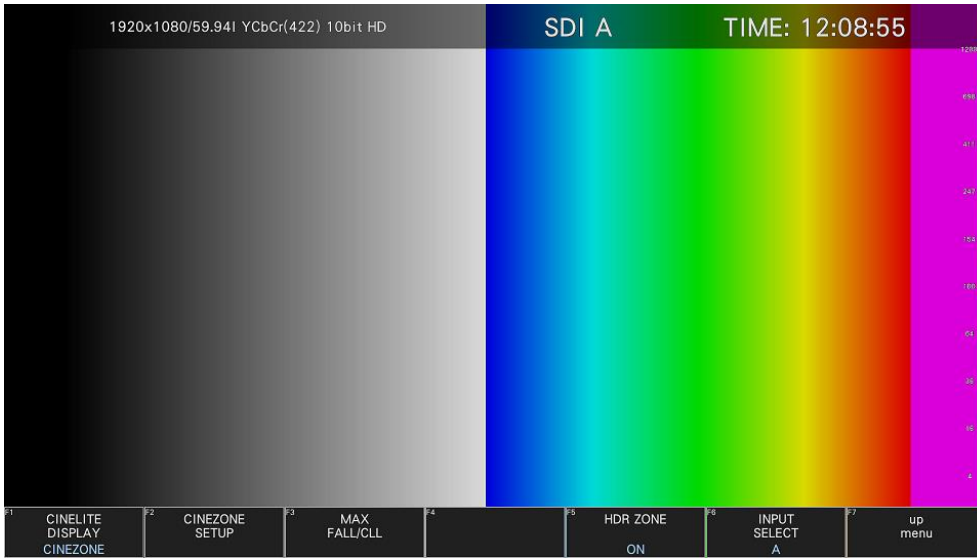

CINELITE DISPLAY = %DISP & CINEZONE

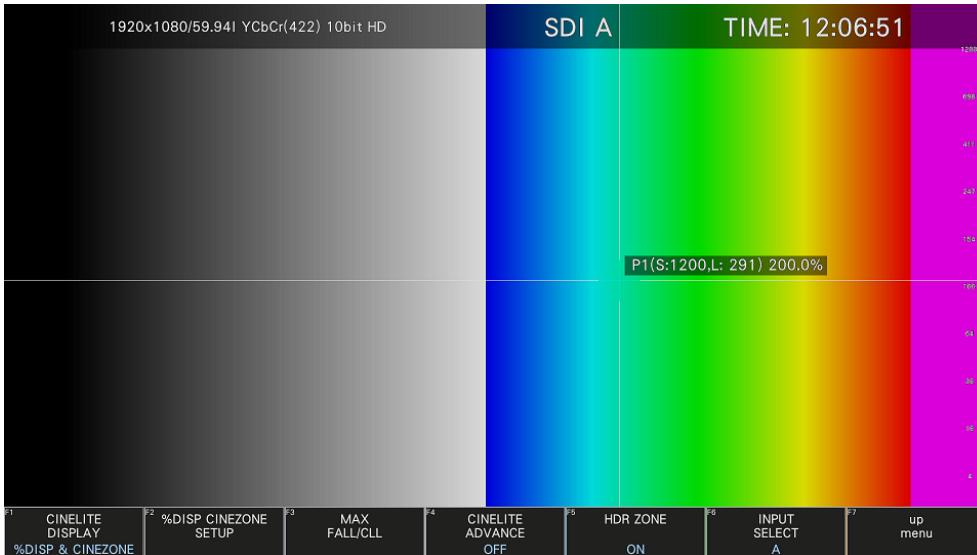

Figure 14-8 CINELITE and CINEZONE displays

14. HDR DISPLAY (SER23)

14.3.2 %DISPLAY

On the %DISPLAY of HDR signals, to shows measured values for HDR signals, follow the procedure below to set **F•4** UNIT SELECT to HDR. In addition, even if the brightness level is 80% or higher or 0% or lower, measured values are displayed in white, not yellow.

Use the %DISP SETUP menu to configure the %DISPLAY settings.

[See also] %DISP SETUP → 13.5.8, "Configuring CINELITE Settings"

PIC → **F•2** CINELITE/HDR → **F•2** %DISP SETUP → **F•4** UNIT SELECT: Y% / RGB% / RGB255 / CV / CV(DEC) / HDR

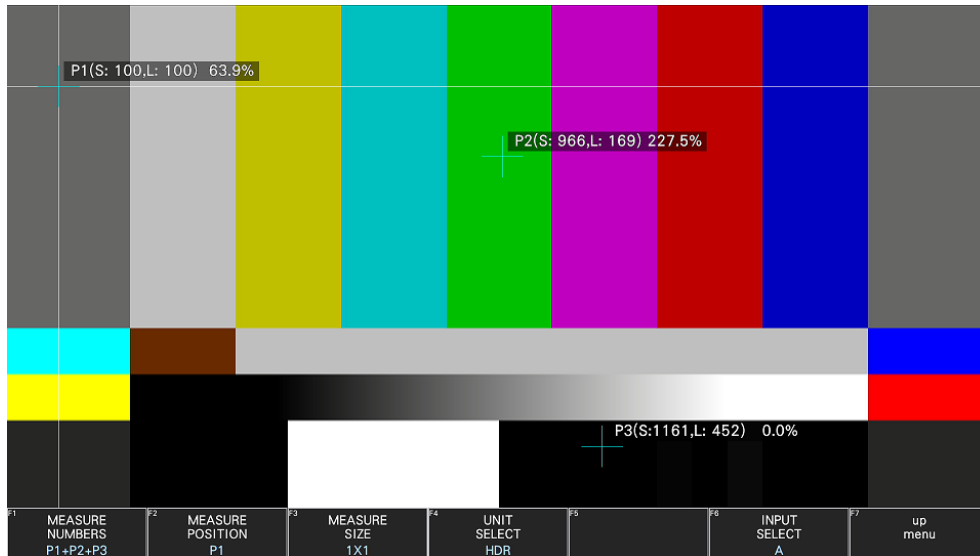

Figure 14-9 %DISPLAY

14.3.3 CINEZONE Display

On the CINEZONE display of HDR signals, to display the SDR area in monochrome and HDR area in color, follow the procedure below to set **F•5** HDR ZONE to ON.

If **F•5** HDR ZONE is set to ON, STEP and SEARCH cannot be selected for **F•1** CINEZONE FORM.

Procedure

PIC	→	F•2	CINELITE/HDR	→	F•5	HDR ZONE: OFF / ON
-----	---	-----	--------------	---	-----	--------------------

HDR ZONE = OFF

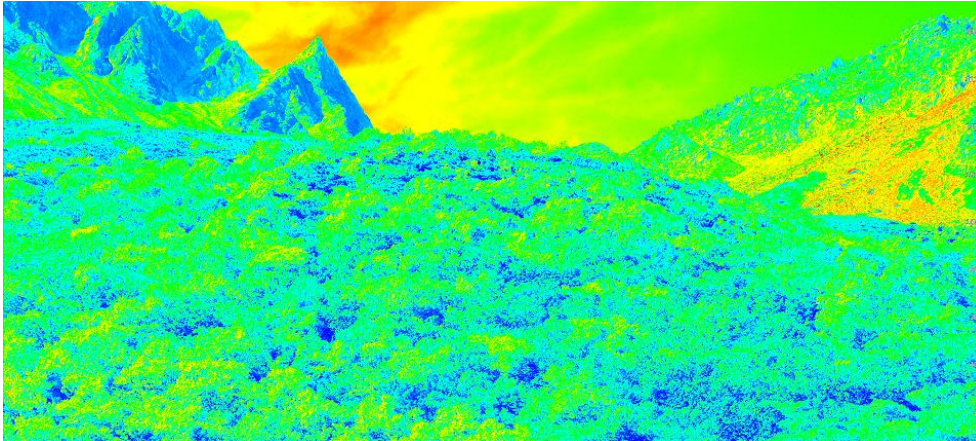

HDR ZONE = ON

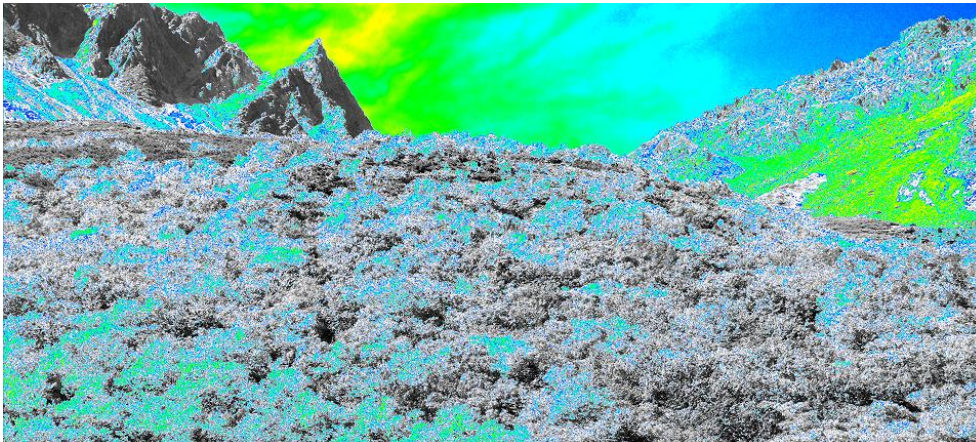

Figure 14-10 CINEZONE display

14. HDR DISPLAY (SER23)

To set the display colors, follow the procedure below. If you set REF at boundary of the SDR area and HDR area, the SDR area can be displayed in monochrome and HDR area in color. When Variable is set to on on the HDR tab, you can set the REF value. If set to off, the default value is used.

This setting is shared with REF.LEVEL [%] of the video signal waveform display.

UPPER or higher:	Magenta
REF or higher, less than UPPER:	Gradation from blue to red
LOWER or higher, less than REF:	Monochrome
Less than LOWER:	Black

Procedure

PIC	→	F•2	CINELITE/HDR	→	F•2	CINEZONE SETUP
		→	F•2			UPPER [%]
		→	F•3			LOWER [%]
		→	F•4			REF [%]

The values vary depending on the HDR tab settings as follows.

Set the values as percentages (0.0 to 100.0%) of the input video level.

HDR equivalent values are displayed in the upper left corner of the screen.

Figure 14-1 Display color values

HDR Mode	EI	Range	Setting range	Default UPPER value	Default LOWER value	Default REF value
HLG	-	Narrow	0.0 to 109.4	100.0	0.0	Ref. Level
		Full	0.0 to 100.0	100.0	0.0	Ref. Level
PQ	-	Narrow	0.0 to 109.4	100.0	0.0	Ref. Level
		Full	0.0 to 100.0	100.0	0.0	Ref. Level
S-Log3	-	-	3.5 to 109.4	100.0	3.5	61.0
C-Log	-	-	7.3 to 108.7	100.0	7.3	63.0
Log-C	200	-	3.5 to 90.1	90.0	3.5	58
	400	-	3.5 to 97.4	90.0	3.5	58
	800	-	3.5 to 104.1	90.0	3.5	58
	1600	-	3.5 to 109.4	90.0	3.5	58
PayloadID UnSpec:S-Log3	Operates in OFF (SDR-TV), HLG, or PQ mode according to the payload ID information. When the payload ID information is Unspecified, the instrument operates in S-Log3 mode.					
PayloadID UnSpec:C-Log	Operates in OFF (SDR-TV), HLG, or PQ mode according to the payload ID information. When the payload ID information is Unspecified, the instrument operates in C-Log mode.					
PayloadID UnSpec:Log-C	Operates in OFF (SDR-TV), HLG, or PQ mode according to the payload ID information. When the payload ID information is Unspecified, the instrument operates in Log-C mode.					

14.3.4 Link Marker Display

Use **F•4** CINELITE ADVANCE to configure the link marker display settings.

[See also] CINELITE ADVANCE → 13.6.8, "Displaying Link Markers"

PIC	→	F•2	CINELITE/HDR	→	F•4	CINELITE ADVANCE: ON / OFF
-----	---	-----	--------------	---	-----	----------------------------

14.4 MAX FALL and MAX CLL Displays

MAX FALL (Maximum Frame Average Light Level) is a function that calculates the maximum value among the R, G, and B values in each pixel and sums the maximums of all pixels. The sum is divided by the number of pixels per frame to derive the average in the frame. The average of each frame is compared among all frames from the start of measurement, and the maximum value is displayed.

The R, G, and B values are converted linearly from the start of the calculation through OETF or InverseOETF.

MAX CLL (Maximum Content Light Level) is a function that displays the maximum value among the R, G, and B values from the start of measurement. The R, G, and B values are converted linearly.

The R, G, and B values are converted linearly from the start of the calculation through OETF or InverseOETF.

14.4.1 Turning the Display On and Off

To display MAX FALL and MAX CLL at the top of the screen, follow the procedure below to turn the function on.

Procedure

PIC	→	F•2	CINELITE/HDR	→	F•3	MAX FALL/CLL	→	F•1	MAX FALL/CLL DISPLAY: OFF / ON
-----	---	-----	--------------	---	-----	--------------	---	-----	--------------------------------

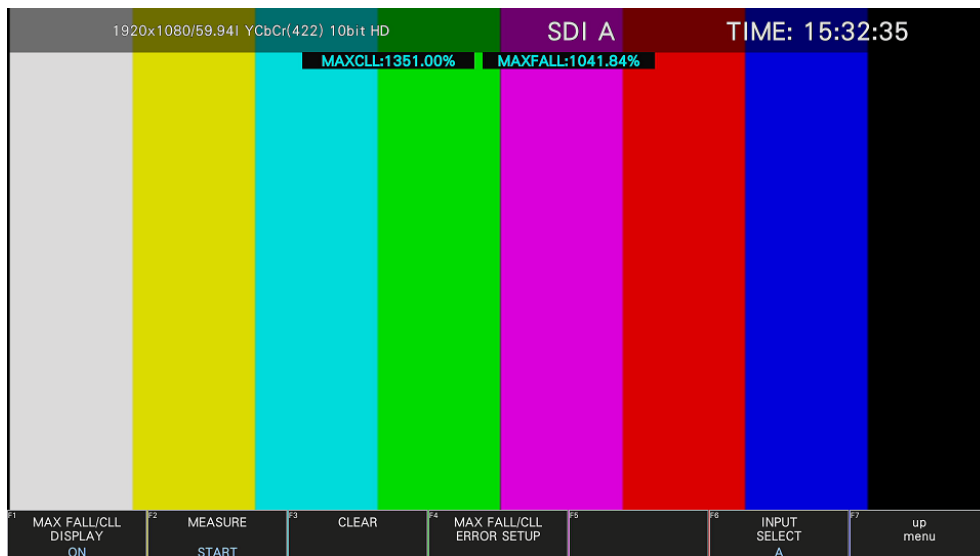

Figure 14-11 MAX FALL and MAX CLL displays

14.4.2 Starting and Stopping Measurements

To start or stop MAX FALL and MAX CLL measurements, follow the procedure below.

Procedure

PIC	→	F•2	CINELITE/HDR	→	F•3	MAX FALL/CLL	→	F•2	MEASURE: <u>STOP</u> / START
-----	---	-----	--------------	---	-----	--------------	---	-----	------------------------------

14.4.3 Clearing Measurements

To clear MAX FALL and MAX CLL measurements, follow the procedure below.

14. HDR DISPLAY (SER23)

Procedure

PIC → F•2 CINELITE/HDR → F•3 MAX FALL/CLL → F•3 CLEAR

14.4.4 Setting the MAX FALL/CLL Error

To display the MAX FALL/CLL error setting screen, follow the procedure below.

Procedure

PIC → F•2 CINELITE/HDR → F•3 MAX FALL/CLL → F•4 MAX FALL/CLL ERROR SETUP

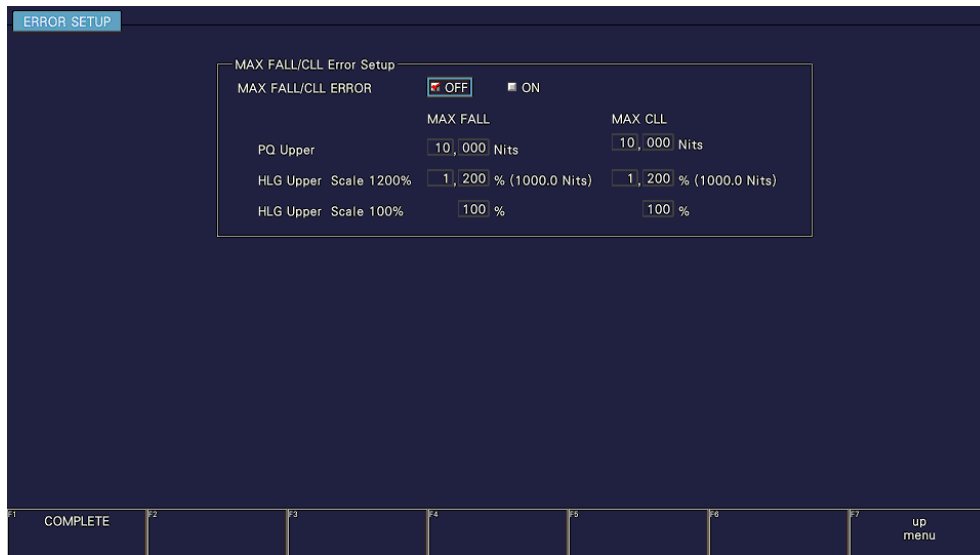

Figure 14-12 MAX FALL/CLL error setting screen

- MAX FALL/CLL ERROR

To turn the MAX FALL/CLL error on and off.

When set to on, when the measurement result is equal to or greater than the specified threshold, it is displayed turns red and recorded as the event log.

[See also] 16.4, "Configuring Event Log Settings."

OFF / ON

- PQ Upper

Set the threshold for PQ.

MAX FALL: 0.000 Nits to 10.000 Nits

MAX CLL: 0.000 Nits to 10.000 Nits

14. HDR DISPLAY (SER23)

- HLG Upper Scale 1200% / 100%

Set the threshold for HLG.

When the function dial (F•D) is turned, the threshold values of HLG Scale 1200% and 100% change at the same ratio.

HLG Scale = 1200%

MAX FALL:	0,000 % (0.0 Nits) to <u>1,200</u> % (1000.0 Nits) to 2,000 % (1845.9 Nits)
MAX CLL:	0,000 % (0.0 Nits) to <u>1,200</u> % (1000.0 Nits) to 2,000 % (1845.9 Nits)

HLG Scale = 100%

MAX FALL:	0 % to <u>60</u> % to 100 %
MAX CLL:	0 % to <u>60</u> % to 100 %

15. AUDIO DISPLAY

To display the audio screen, press AUDIO.

If SER03 is not installed, the embedded audio signal of the SDI signal can be displayed on the meter (up to 8 channels).

When SER03 is installed, one of lissajous, surround, status, and loudness can be displayed at the same time as meter (up to 16 channels). External audio signals applied to DIGITAL AUDIO INPUT/OUTPUT and ANALOG AUDIO can also be measured. DIGITAL AUDIO INPUT/OUTPUT and ANALOG AUDIO terminals can also be used as output by switching them on the AUDIO IN/OUT tab.

When measuring embedded audio, switching to simul mode enables SDI inputs A to D to be displayed in combination with the audio. (They can be displayed even if **F•1** A to **F•4** D on the INPUT menu are set to OFF.)

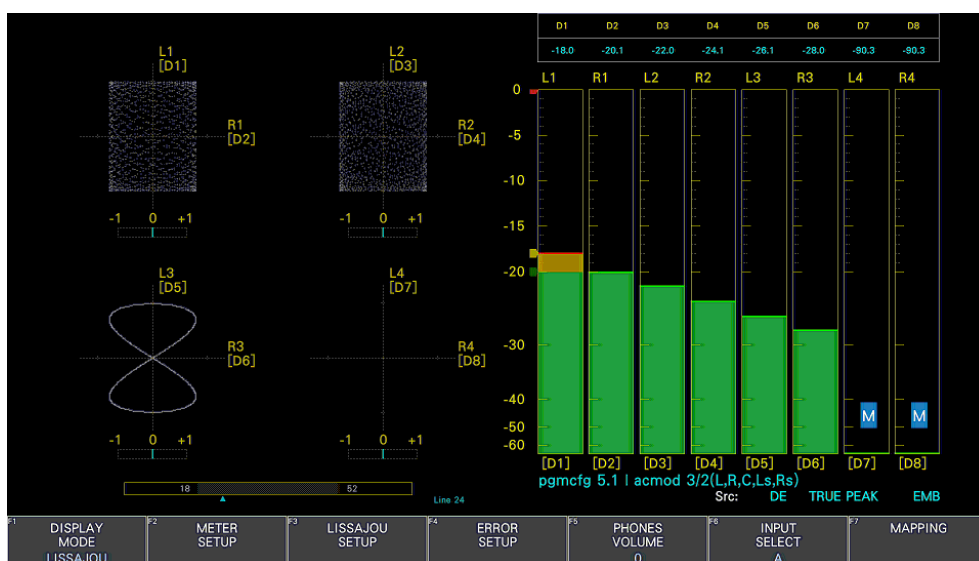

Figure 15-1 Audio display

- Indicators (SER04)

During Dolby E measurement, set Dolby E Line Position to ON on the DOLBY SETTING tab to display the frame location value with a line and ▲ below the Lissajous and surround displays. These are normally shown in cyan, but when the value exceeds the specified threshold, they turn red.

- pgmcf and acmod (SER04)

During Dolby measurement, the program configuration and audio configuration mode are displayed in the lower right of the screen.

15. AUDIO DISPLAY

- Src

The Src line in the lower right of the display shows the following information in order from the left.

	Display	Description	Reference
1. Input signal display	AES	-	15.1
	DE	Dolby E (SER04)	
	DD	Dolby Digital (SER04)	
	DDP	Dolby Digital Plus (SER04)	
2. Meter response model display	TRUE PEAK / PPM(I) / PPM(II) / VU+TRUE / VU+PPM(I) / VU+PPM(II)	-	15.5.2
3. Measurement signal display	EMB	Embedded audio	15.1
	AES	External digital audio	
	ANA	External analog audio	

15.1 Setting the Signals to Measure

To configure the measurement signal settings, press **F•7** MAPPING on the AUDIO menu.

Procedure

AUDIO → **F•7** MAPPING

15.1.1 Selecting the Measurement Signal

On the TARGET tab, select the measurement signal, select the audio group, and assign the headphone output.

AUDIO → **F•7** MAPPING → **F•2** PREV TAB or **F•3** NEXT TAB →



Figure 15-2 TARGET tab

- Input

Set the input signal to EMB AUDIO, EXT AUDIO, or ANALOG.

If SER03 is not installed, the input signal is fixed to EMB AUDIO.

EMB AUDIO:	The embedded audio signal applied to SDI INPUT and IP is measured.
EXT AUDIO:	The external audio signal applied to DIGITAL AUDIO INPUT/OUTPUT is measured. If both EXTERNAL AUDIO settings are set to OUTPUT on AUDIO IN/OUT tab, you cannot select EXT AUDIO.
ANALOG:	The external audio signal applied to ANALOG AUDIO is measured. If ANALOG AUDIO is set to OUTPUT on AUDIO IN/OUT tab, you cannot select ANALOG AUDIO.

- 3G-B Stream Select

If INPUT is set to EMB AUDIO, select the 3G-B stream.

This is invalid when the input signal is not 3G-B.

15. AUDIO DISPLAY

- EXT Audio Input Group

If INPUT is set to EXT AUDIO and both EXTERNAL AUDIO settings are set to Input on the AUDIO IN/OUT tab, select the input group.

A / B

- Dolby (SER04)

During single input mode, turn the Dolby signal measurement on or off.

When set to on, the Dolby signal type (Dolby E, Dolby Digital, Dolby Digital Plus) is automatically detected.

This cannot be selected when INPUT is set to ANALOG.

OFF / ON

- Decode CH Group (SER04)

When Dolby is set to on, select the decode channel.

This cannot be selected when INPUT is set to ANALOG.

- CH Mode

Select the number of measurement channels.

If INPUT is set to EXT AUDIO and either of the EXTERNAL AUDIO settings is set to Output on the AUDIO IN/OUT tab, you cannot select 16ch.

When Dolby is set to on, turn mix mode on or off. For details, see “• Mix mode.”

This cannot be selected when INPUT is set to ANALOG.

When SER03 is not installed, it is fixed to 8ch.

When Dolby is off

8ch / 16ch

When Dolby is on

8ch / 16ch (MIX)

- Group CH Assign

When SER03 is not installed and input mode is set to simul, the measurement channels in the group are assigned.

When System is other than 2K SD/HD/3G-A/3G-B-DL(/IP), this cannot be set.

CH: 1-4: The settings for 1st Group and 2nd Group in GROUP SELECT are valid.

CH: 1/2: The settings from 1st Group to 4th Group in GROUP SELECT are valid.

Select from the following channels for each group.

G1:CH1/2, G2:CH5/6, G3:CH9/10, G4:CH13/14

CH: 3/4: The settings from 1st Group to 4th Group in GROUP SELECT are valid.

Select from the following channels for each group.

G1:CH3/4, G2:CH7/8, G3:CH11/12, G4:CH15/16

15. AUDIO DISPLAY

- PHONES

Select the headphone output channel.

- GROUP SELECT

Select the audio group.

If INPUT is set to EMB AUDIO in simul mode, also select the input channel.

This cannot be selected when INPUT is set to ANALOG.

G1: 1 to 4ch, G2: 5 to 8ch, G3: 9 to 12ch, G4: 13 to 16ch

- Mixed mode (SER04)

Mix mode is a feature that simultaneously displays the audio signal before decoding and the Dolby signal after decoding. The measurement signal varies as follows depending on the INPUT and CH Mode settings.

- When INPUT is set to EMB AUDIO and CH Mode is set to 8ch

Channels selected using Decode CH Group are decoded and displayed as channels D1 to D8.

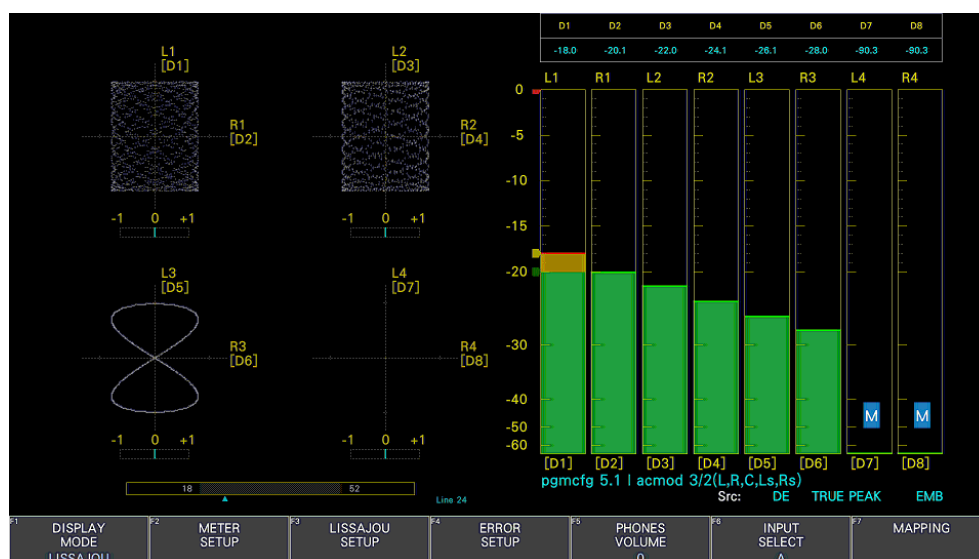

Figure 15-3 E EMB Dolby display

15. AUDIO DISPLAY

- When INPUT is set to EMB AUDIO and CH Mode is set to 16ch (MIX)

The left half shows the embedded audio signals of the channels selected with GROUP SELECT.

The right half shows channels D1 to D8, which are the decoded signals of the channels selected using Decode CH Group.

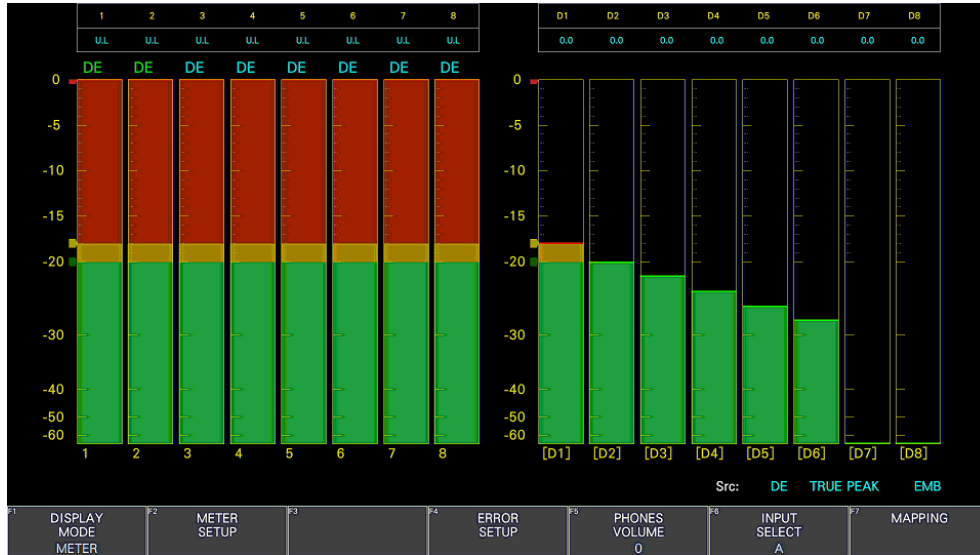

Figure 15-4 EMB Dolby display (mix)

- When INPUT is set to EXT AUDIO and CH Mode is set to 8ch

Channels selected using Decode CH Group are decoded and displayed as channels D1 to D8.

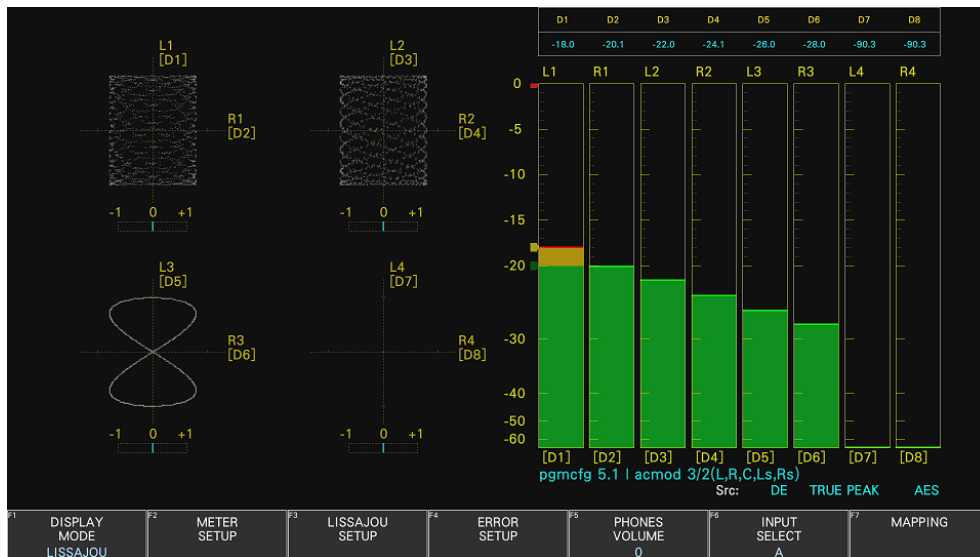

Figure 15-5 AES Dolby display

15. AUDIO DISPLAY

- When INPUT is set to EXT AUDIO and CH Mode is set to 16ch (MIX)

The left half shows the external audio signals of the group selected with EXT Audio Input Group.

The right half shows channels D1 to D8, which are the decoded signals of the channels selected using Decode CH Group.



Figure 15-6 AES Dolby display (mix)

15. AUDIO DISPLAY

15.1.2 Channel Assignment for the Lissajous Display (SER03)

On the LISSAJOU tab, assign channels from the audio group selected with GROUP SELECT and Lt and Rt (excluding some channels).

AUDIO → F.7 MAPPING → F.2 PREV TAB or F.3 NEXT TAB →



Figure 15-7 LISSAJOU tab

15.1.3 Channel Assignment for the Surround Display (SER03)

On the SURROUND tab, assign channels from the audio group selected with GROUP SELECT.

AUDIO → F.7 MAPPING → F.2 PREV TAB or F.3 NEXT TAB →

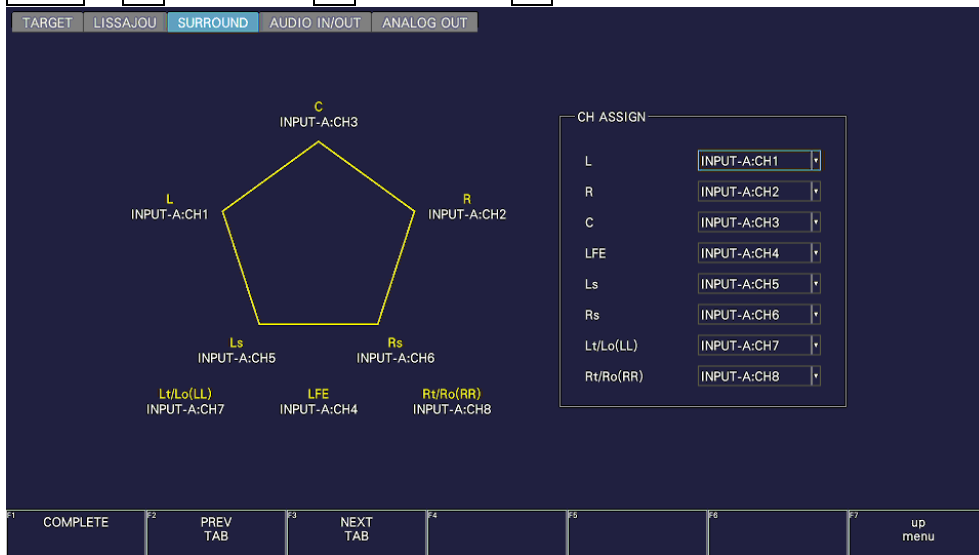

Figure 15-8 SURROUND tab

15. AUDIO DISPLAY

15.1.4 Configuring the Dolby Settings (SER04)

When Dolby is set to on, you can configure the Dolby settings using the DOLBY tab.

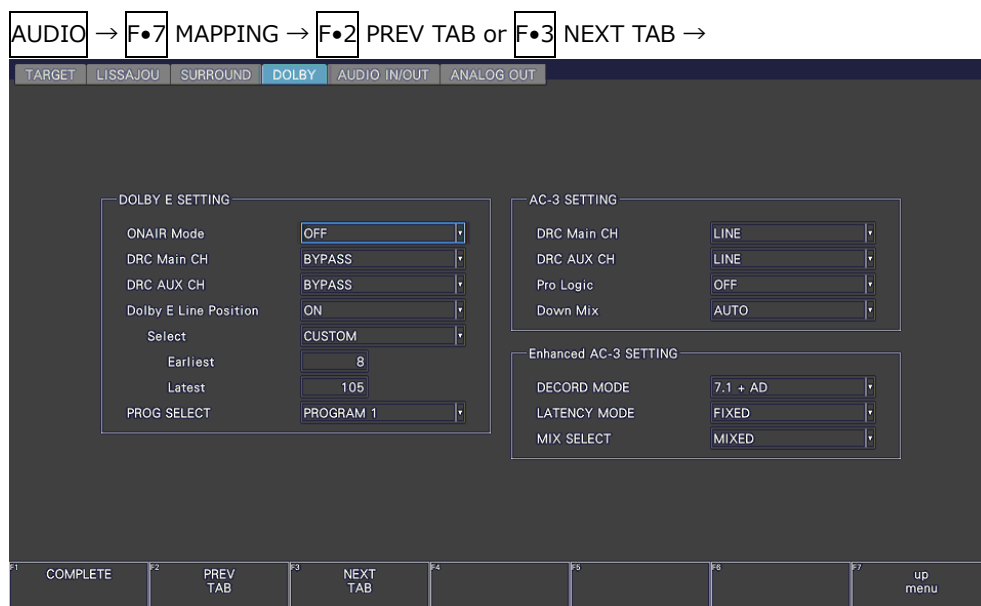

Figure 15-9 DOLBY tab

Table 15-1 DOLBY tab explanation

Item	Description	
DOLBY E SETTING	ONAIR Mode	Turns ONAIR MODE on or off.
	DRC Main CH	Select DRC.
	DRC AUX CH	Select auxiliary DRC.
	Dolby E Line Position	Turns the frame location indicator display on and off.
	Select	Select the type of frame location threshold value. The lower limit (Earliest) and upper limit (Latest) when VALID or IDEAL is selected automatically change depending on the format. If you select CUSTOM, you can specify a value between 8 and 105.
	PROG SELECT	Select the program.
AC-3 SETTING (Dolby Digital)	DRC Main CH	Select DRC.
	DRC AUX CH	Select auxiliary DRC.
	Pro Logic	Turns Pro Logic II on or off.
	Down Mix	Select the downmix mode.
Enhanced AC-3 SETTING (Dolby Digital Plus)	DECODE MODE	Select the decode mode.
	LATENCY MODE	Select the latency mode.
	MIX SELECT	Select the mix configuration.

15. AUDIO DISPLAY

15.1.5 Configuring Audio Input/Output Connectors (SER03)

Use the AUDIO IN/OUT tab to configure the DIGITAL AUDIO INPUT/OUTPUT and ANALOG AUDIO connectors on the rear panel.



Figure 15-10 AUDIO IN/OUT tab

- EXTERNAL AUDIO

Select whether to use the DIGITAL AUDIO INPUT/OUTPUT connectors of each group as input connectors or output connectors.

INPUT / OUTPUT

- ANALOG AUDIO

Select whether to use ANALOG AUDIO as input connectors or output connectors.

INPUT / OUTPUT

15. AUDIO DISPLAY

15.1.6 Channel Assignment for the Analog Audio Output Connector (SER03)

On the ANALOG OUT tab, if ANALOG AUDIO is set to OUTPUT on the AUDIO IN/OUT tab, assign channels to the ANALOG AUDIO connectors on the rear panel.

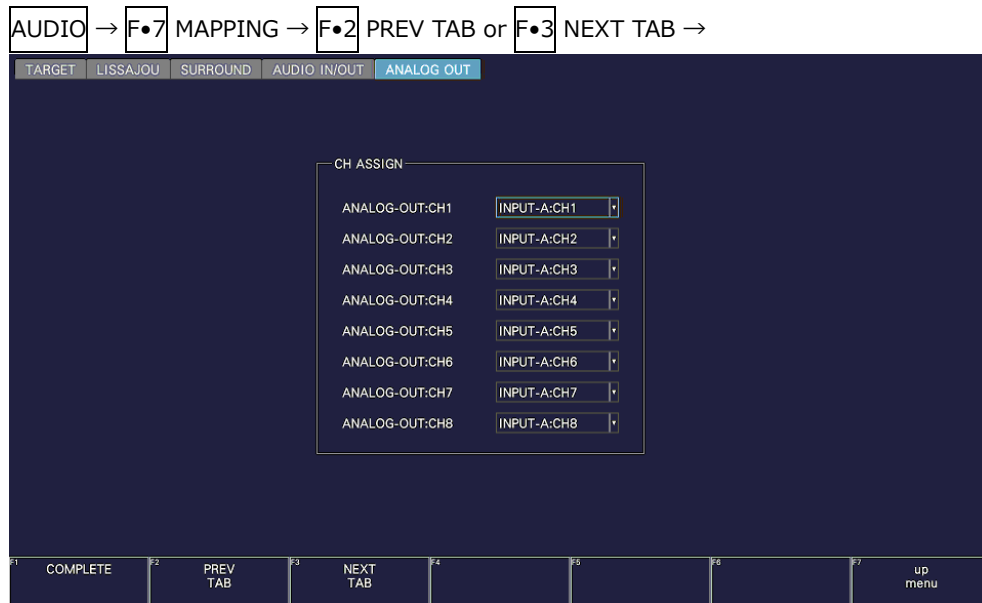

Figure 15-11 ANALOG OUT tab

15. AUDIO DISPLAY

15.1.7 Labeling IP signals (SER06)

You can add a label to the IP signal meter display on the IP CH MAP LABEL tab. This setting is valid for streams for which Audio Ch Mapping on the IP SETUP1 tab is set to ON.

Select the stream in the Select, then set the labels for Ch1 to Ch16. The actual label name is displayed at the bottom of the screen.

DEFAULT / Mono / Dual Mono / Standard Stereo / Matrix Stereo /
 5.1ch(LCR) / 5.1ch(LRC) / 7.1ch(LCR) / 7.1ch(LRC) / 7.1.4ch(LCR) / 7.1.4ch(LRC) /
 Undefined / U01 / U02 / U03 / U04 / U05 / U06 / U07 / U08 / U09 / U10 /
 U11 / U12 / U13 / U14 / U15 / U16

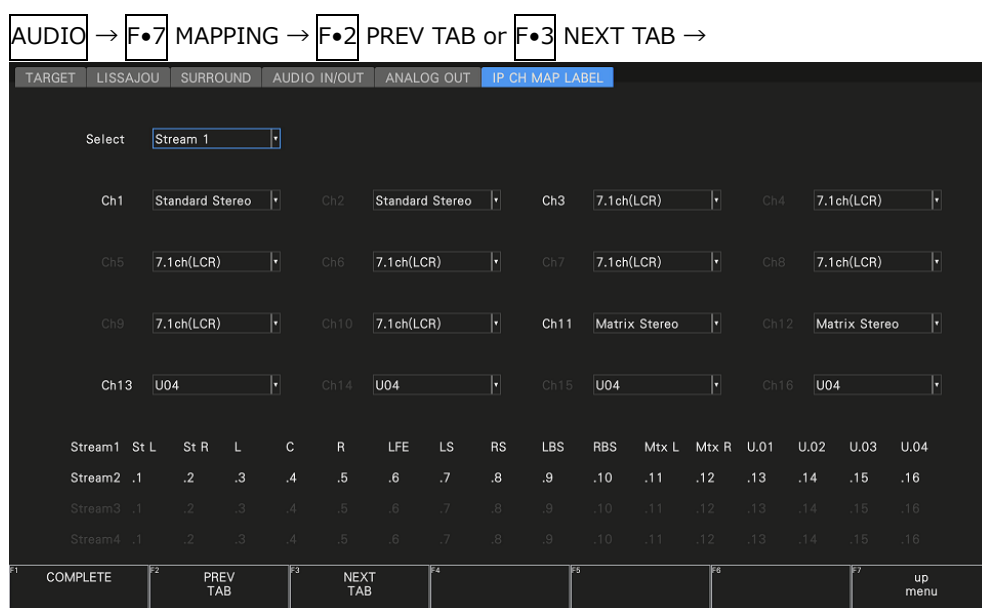

Figure 15-12 IP CH MAP LABEL tab

15. AUDIO DISPLAY

The label name for the selected label is shown below.

Labels are automatically set for the following channels starting from the set channel.
For example, if Ch3 is set to 7.1ch(LCR), 8 channels from Ch3 to Ch10 will be automatically set.

(Ch3 = L, Ch4 = C, Ch5 = R, Ch6 = LFE, Ch7 = LS, Ch8 = RS, Ch9 = LBS, Ch10 = RBS)

Table 15-2 Label Name

Label	Label Name											
	1	2	3	4	5	6	7	8	9	10	11	12
DEFAULT	1-16	-	-	-	-	-	-	-	-	-	-	-
Mono	M	-	-	-	-	-	-	-	-	-	-	-
Dual Mono	M1	M2	-	-	-	-	-	-	-	-	-	-
Standard Stereo	St L	St R	-	-	-	-	-	-	-	-	-	-
Matrix Stereo	Mtx L	Mtx R	-	-	-	-	-	-	-	-	-	-
5.1ch(LCR)	L	C	R	LFE	LS	RS	-	-	-	-	-	-
5.1ch(LRC)	L	R	C	LFE	LS	RS	-	-	-	-	-	-
7.1ch(LCR)	L	C	R	LFE	LS	RS	LBS	RBS	-	-	-	-
7.1ch(LRC)	L	R	C	LFE	LS	RS	LBS	RBS	-	-	-	-
7.1.4ch(LCR)	L	C	R	LFE	LS	RS	LBS	RBS	LTF	RTF	LTR	RTR
7.1.4ch(LRC)	L	R	C	LFE	LS	RS	LBS	RBS	LTF	RTF	LTR	RTR
Undefined	U.01	-	-	-	-	-	-	-	-	-	-	-
U01	U.01	-	-	-	-	-	-	-	-	-	-	-
U02	U.01	U.02	-	-	-	-	-	-	-	-	-	-
U03	U.01	U.02	U.03	-	-	-	-	-	-	-	-	-
⋮												

The label will appear at the bottom of the meter.

Normally, when the meter displays 16 channels, it is displayed separated into 8 channels, but when Audio Ch Mapping on the IP SETUP1 tab is set to ON, it is displayed without separation.

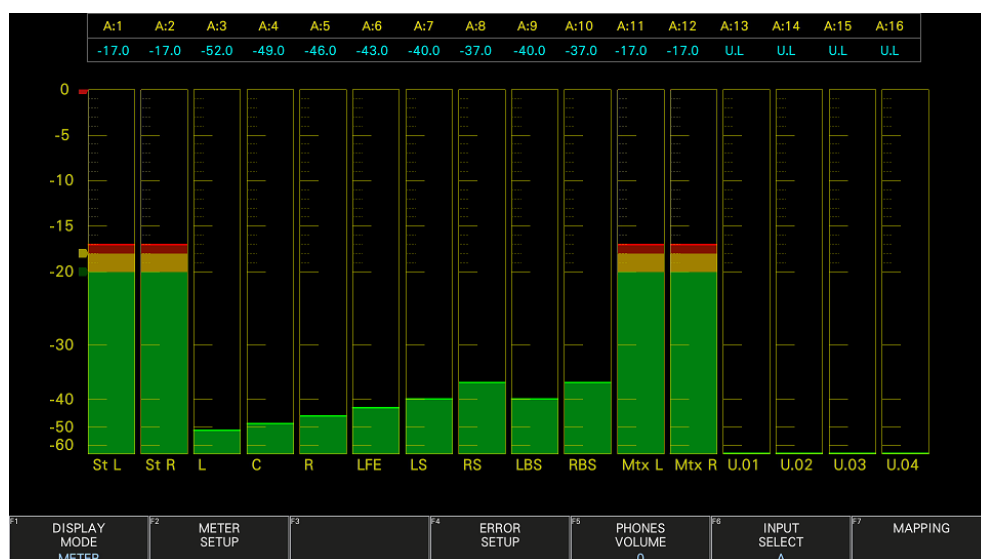

Figure 15-13 Meter display

15.2 Selecting the Display Mode (SER03)

To select the display mode, follow the procedure below.

Procedure

AUDIO	→	F•1	DISPLAY MODE: <u>LISSAJOU</u> / SURROUND / METER / STATUS
-------	---	-----	---

Settings

- LISSAJOU:** Lissajous curves are displayed. During 8-channel measurement, audio meters are also displayed.
- SURROUND:** The surround display is shown on the left side of the screen, and the audio meter is displayed on the right side of the screen. This option cannot be selected when during 16-channel measurement or in simul mode during embedded audio measurement.
- METER:** The audio meters are displayed. This option cannot be selected during 8-channel measurement.
- STATUS:** Shows the status. During 8-channel measurement, audio meters are also displayed.
- LOUDNESS:** The loudness values are displayed on a chart, on a meter, and as values. This option cannot be selected when during 16-channel measurement or in simul mode during embedded audio measurement.

DISPLAY MODE = LISSAJOU

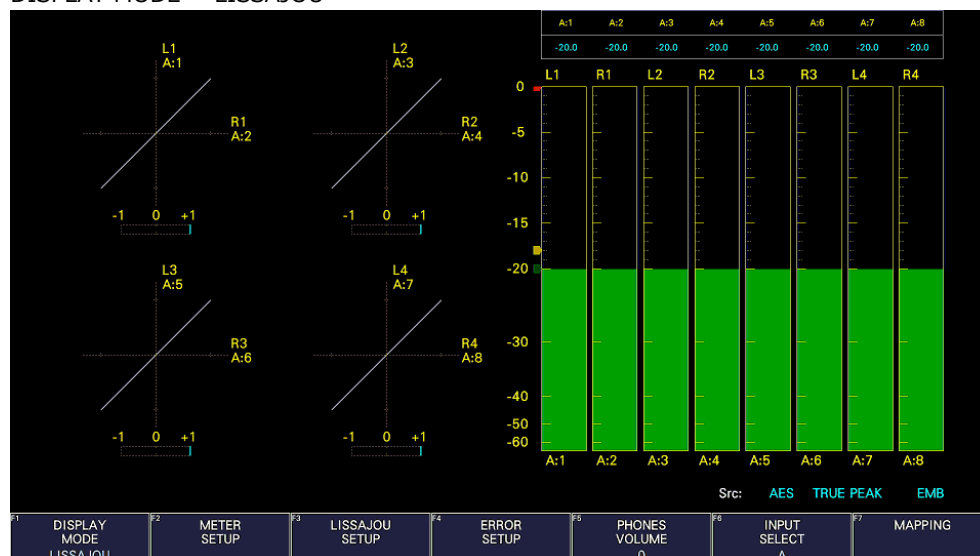

15. AUDIO DISPLAY

DISPLAY MODE = SURROUND

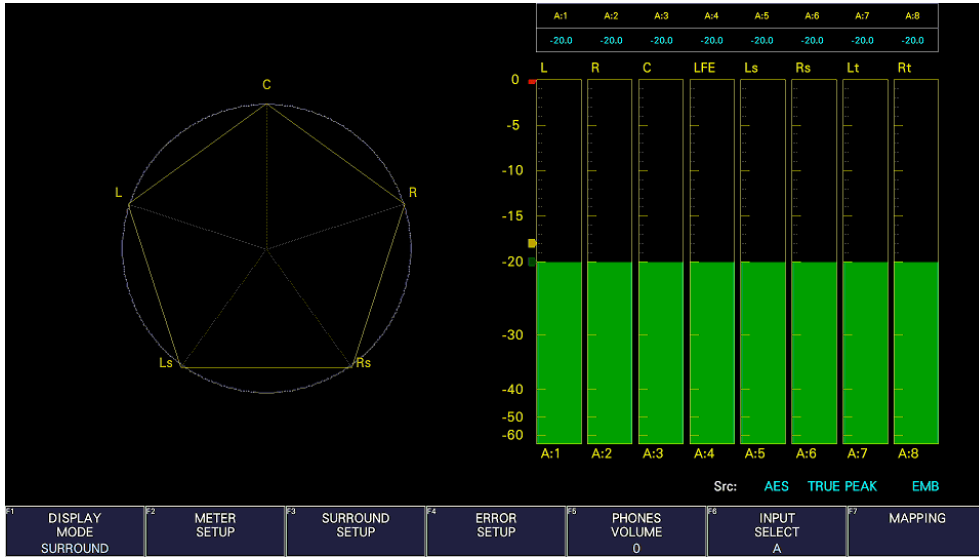

DISPLAY MODE = METER

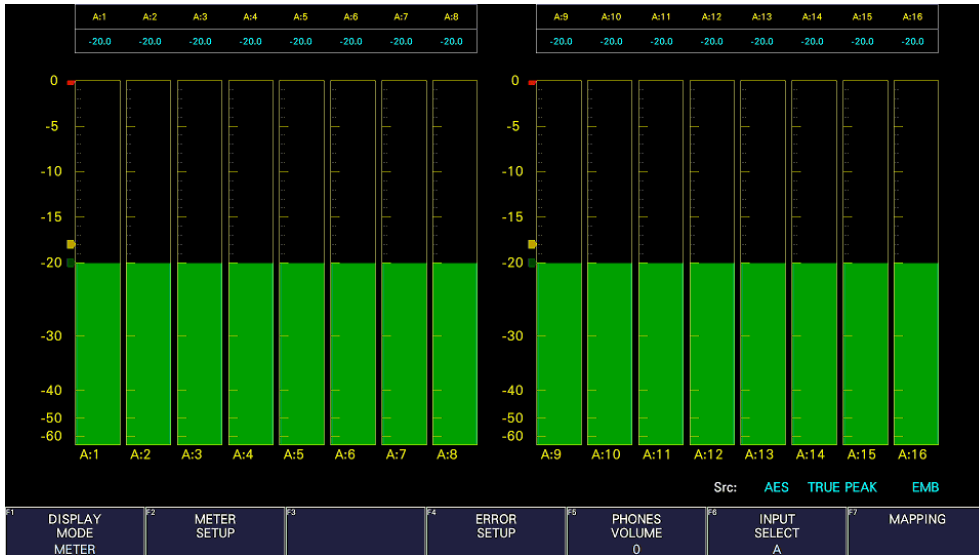

DISPLAY MODE = STATUS

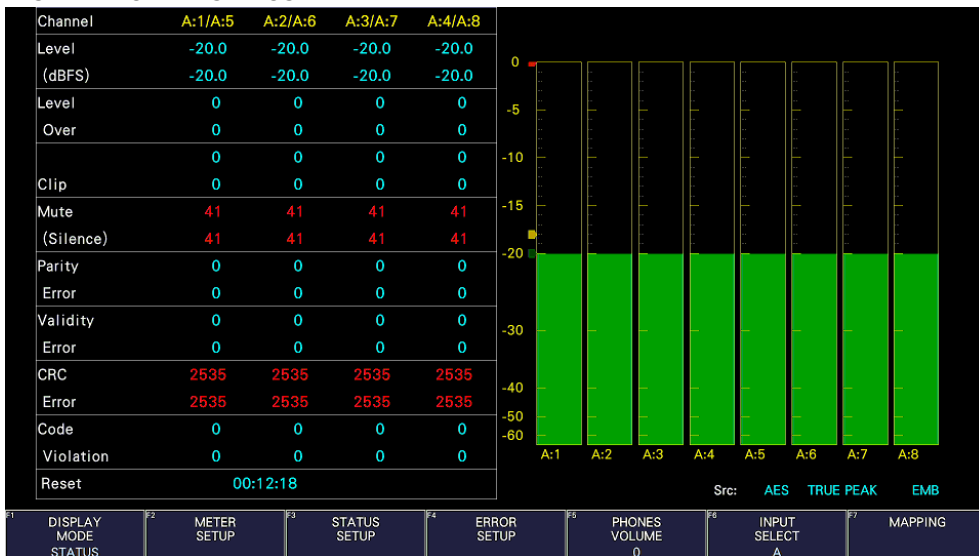

15. AUDIO DISPLAY

DISPLAY MODE = LOUDNESS

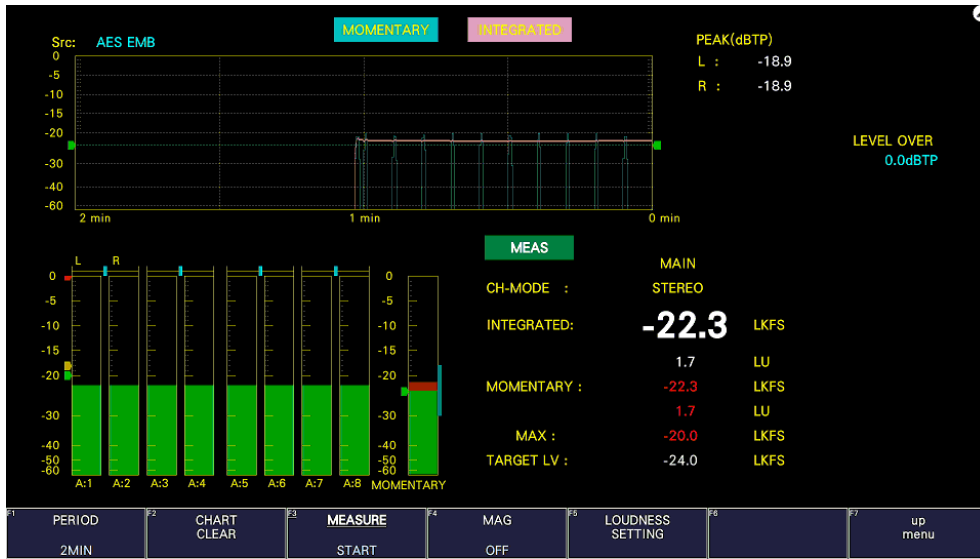

Figure 15-14 Selecting the display mode

15.3 Configuring Error Detection Settings

To configure the error detection, meter display, and status display settings, follow the procedure below.

Procedure

AUDIO → F•4 ERROR SETUP

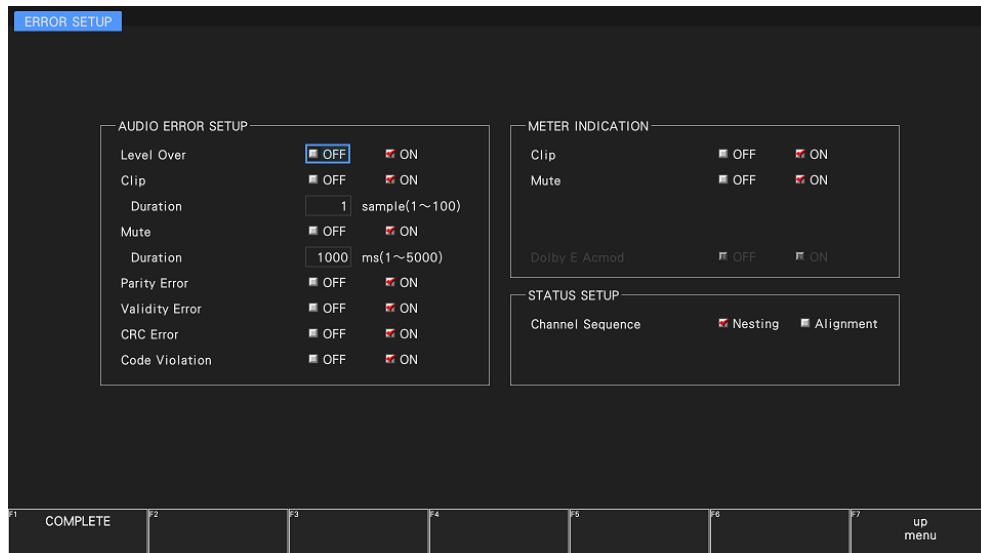

Figure 15-15 ERROR SETUP tab

- Level Over

Turn the level error detection on or off.

An error is detected when the level set with OVER dBFS is exceeded.

[See also] OVER dBFS → 15.5.4, "Setting the Reference Level"

OFF / ON

- Clip (SER03)

Turn the clip error detection on or off.

OFF / ON

If set to ON, you can set the duration. An error is detected when the maximum signal extends beyond the number of samples set here.

1 - 100

- Mute

Turn the mute error detection on or off.

OFF / ON

If set to ON, you can set the duration. An error is detected when a mute signal lasts longer than the duration set here.

1 - 1000 - 5000

15. AUDIO DISPLAY

- Parity Error (SER03)

Turn the parity error detection on or off.

OFF / ON

- Validity Error (SER03)

Turn the validity error detection on or off.

OFF / ON

- CRC Error (SER03)

Turn the CRC error detection on or off.

OFF / ON

- Code Violation (SER03)

Turn the code violation error detection on or off.

OFF / ON

- Clip (METER INDICATION) (SER03)

If Clip is set to ON, turn on or off the "CLIP" indication that appears when errors occur.

OFF / ON

- Mute (METER INDICATION)

If Mute is set to ON, turn on or off the "M" indication that appears when errors occur.

OFF / ON

- Dolby E Acmod (SER04) (SER03)

During Dolby E measurement, turn on or off the NOT USE display that appears when LFEch is not used.

OFF / ON

- Channel Sequence (SER03)

Select the order of channels in the status display.

Nesting: Nest channels like 1/5, 2/6, 3/7, 4/8.

Alignment: Order the channels like 1/2, 3/4, 5/6, 7/8.

15.4 Adjusting the Volume

To adjust the headphone volume, follow the procedure below.

Press the function dial (F•D) to return the setting to its default value (0).

Procedure

AUDIO	→	F•5	PHONES VOLUME: <u>0</u> - 63
-------	---	-----	------------------------------

15.5 Meter Display

Meters are always displayed excluding the Lissajous display and status display during 16-channel management.

When SER03 is not installed, the meter display is fixed at 8 channels.

To configure meter display settings, press **F•2** METER SETUP on the AUDIO menu.

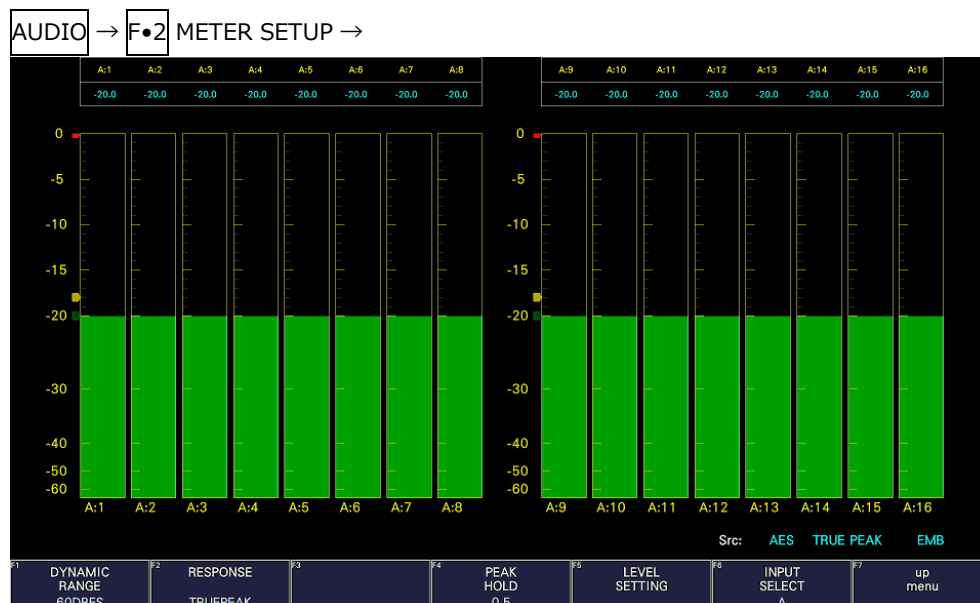

Figure 15-16 Meter display

15.5.1 Selecting the Scale

To select the meter's scale, follow the procedure below.

However, if Input is set to ANALOG on the TARGET tab and ANALOG AUDIO is set to INPUT on the AUDIO IN/OUT tab, you cannot select 90DBFS.

Procedure

AUDIO → **F•2** METER SETUP → **F•1** DYNAMIC RANGE: 60DBFS / 90DBFS / MAG

Settings

60DBFS:	The meter's scale is set to -60 to 0 (dBFS).
90DBFS:	The meter's scale is set to -90 to 0 (dBFS).
MAG:	The meter's scale is set to the level specified by F•5 LEVEL SETTING → F•3 REF dBFS ±3 dB.

15. AUDIO DISPLAY

15.5.2 Selecting the Response Model

To select the meter's response model, follow the procedure below. The selected response model is indicated in the lower right of the screen.

Procedure

AUDIO → F•2 METER SETUP
 → F•2 RESPONSE: TRUEPEAK / PPM / VU
 → F•3 PPM MODE: PPM(I) / PPM(II) (for PPM)
 → F•3 PEAK METER: TRUE / PPM(I) / PPM(II) (for VU)

The response model settings (typical) are detailed below.

F•2 RESPONSE	F•3 PPM MODE / F•3 PEAK METER	Display	Delay time (*1)	Return time (*2)	Average time
TRUEPEAK	-	TRUE PEAK	0 msec	1.7 sec	-
PPM	PPM(I)	PPM(I)	10 msec	1.7 sec	-
	PPM(II)	PPM(II)	10 msec	2.8 sec	-
VU	TRUE	VU+TRUE	-	-	300 msec
	PPM(I)	VU+PPM(I)	-	-	300 msec
	PPM(II)	VU+PPM(II)	-	-	300 msec

*1 The amount of time it takes for the meter to show -20 dBFS when a -20 dBFS/1 kHz sine-wave signal is applied with no input preceding it.

*2 The amount of time it takes for the meter to show -40 dBFS when a -20 dBFS/1 kHz sine-wave signal is removed from the input.

15.5.3 Setting the Peak Hold

To set the peak hold time, follow the procedure below. The unit is seconds. You can set the value in 0.5-second steps.

Press the function dial (F•D) to return the setting to its default value (0.5).

Procedure

AUDIO → F•2 METER SETUP (→ F•5 LEVEL SETTING) → F•4 PEAK HOLD: 0.0 - 0.5 - 5.0 / HOLD

15. AUDIO DISPLAY

15.5.4 Setting the Reference Level

To set the reference level, press **F•5** LEVEL SETTING on the METER SETUP menu.

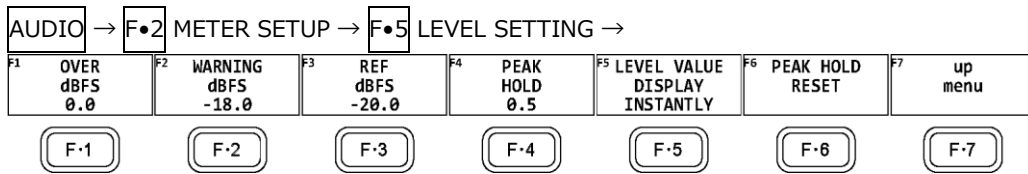
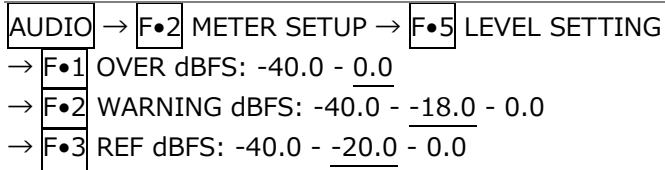

Figure 15-17 LEVEL SETTING menu

To set the meter reference level, follow the procedure below.

Procedure



Settings

OVER dBFS: Set the threshold level for audio level errors.

WARNING dBFS: The portion of the meter that exceeds the level specified here is displayed in red. The portion of the meter below this level is displayed in yellow.

REF dBFS: The portion of the meter that exceeds the level specified here is displayed in yellow. The portion of the meter below this level is displayed in green.

15.5.5 Configuring the Numeric Display

On the meter display, measured values are displayed using a meter and numeric values. You can select the content of the numeric display by following the procedure below. Note that for Level in the status display, the current measured value (INSTANTLY) is displayed regardless of the selection made here.

Procedure

AUDIO → F•2 METER SETUP → F•5 LEVEL SETTING → F•5 LEVEL VALUE DISPLAY:
INSTANTLY / PEAK HOLD

Settings

INSTANTLY:	The current measured value is displayed. Normally, the value is displayed in light blue. When Level Over detection is enabled and the measured value exceeds the value specified using F•1 OVER dBFS, the values displayed in red.
PEAK HOLD:	The peak value set using F•4 PEAK HOLD is displayed. The value is always displayed in green.

15.5.6 Resetting the Peak Hold

To reset the peak hold on the meter display and measured value, follow the procedure below.

Procedure

AUDIO → F•2 METER SETUP → F•5 LEVEL SETTING → F•6 PEAK HOLD RESET

15. AUDIO DISPLAY

15.6 Lissajous Display (SER03)

To display Lissajous curves, set **F•1** DISPLAY MODE on the AUDIO menu to LISSAJOU. To configure the Lissajous display settings, press **F•3** LISSAJOU SETUP. This setting is available when **F•1** DISPLAY MODE is set to LISSAJOU.

AUDIO → **F•1** DISPLAY MODE and select LISSAJOU → **F•3** LISSAJOU SETUP →

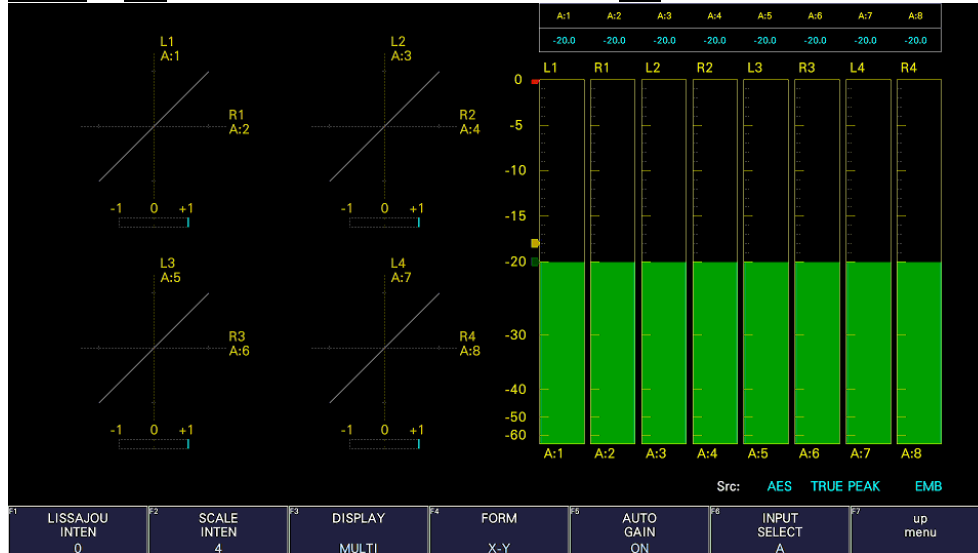

Figure 15-18 Lissajous display

- Correlation Meter

The correlation meter indicates the phase difference between the two signals. A reading of +1 indicates that the signals are in-phase, a reading of -1 indicates that the signals are 180 ° out of phase, and a reading of 0 indicates that the signals are not correlated.

15.6.1 Adjusting the Lissajous Curve Intensity

To set the Lissajous curve intensity, follow the procedure below. Press the function dial (F•D) to return the setting to its default value (0).

Procedure

AUDIO → **F•3** LISSAJOU SETUP → **F•1** LISSAJOU INTEN: -8 - 0 - 7

15.6.2 Adjusting the Scale Intensity

To adjust the intensity of the Lissajous and meter scales, follow the procedure below. Press the function dial (F•D) to return the setting to its default value (4).

Procedure

AUDIO → **F•3** LISSAJOU SETUP → **F•2** SCALE INTEN: -8 - 4 - 7

15. AUDIO DISPLAY

15.6.3 Selecting the Lissajous Curve Display Format

To select the Lissajous curve display format, follow the procedure below.

Procedure

AUDIO	→	F•3	LISSAJOU SETUP	→	F•3	DISPLAY: <u>MULTI</u> / SINGLE
-------	---	-----	----------------	---	-----	--------------------------------

Settings

MULTI: Eight channels of Lissajous waveforms and eight channels of audio meters are displayed or 16 channels of Lissajous waveforms are displayed.

SINGLE: Two channels of Lissajous waveforms and eight channels of audio meters are displayed.

This option cannot be selected in simul mode or 16-channel measurement.

DISPLAY = MULTI

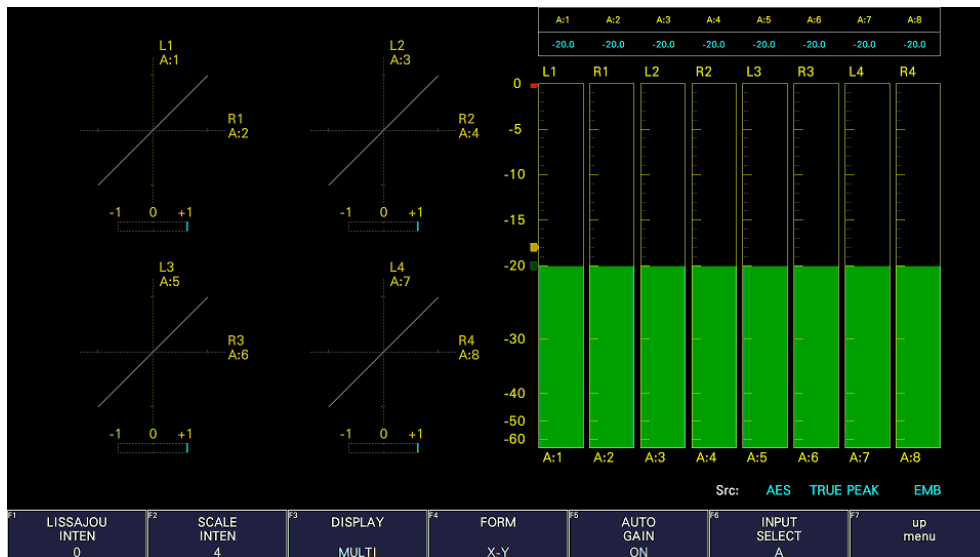

DISPLAY = SINGLE

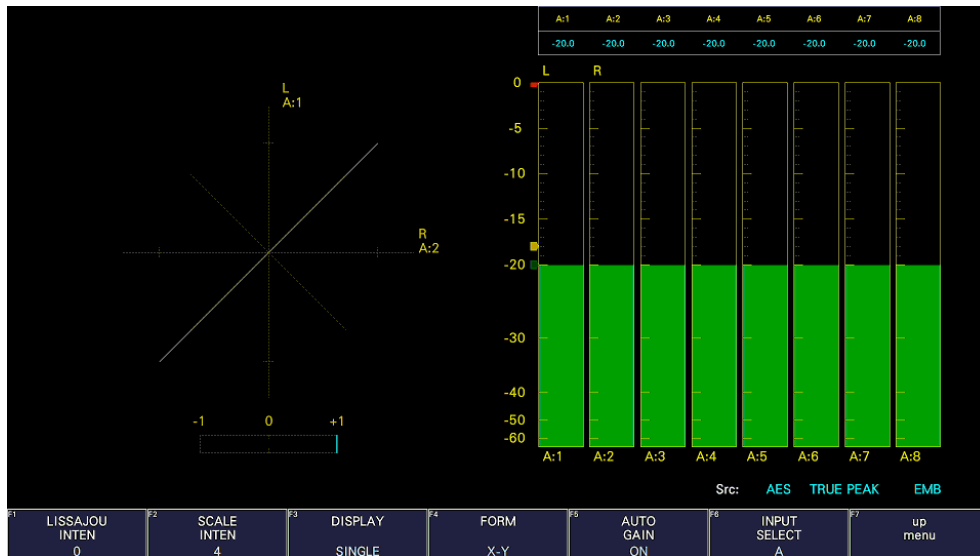

Figure 15-19 Selecting the Lissajous curve display format

15. AUDIO DISPLAY

15.6.4 Selecting the Scale Display Format

To select the scale display format, follow the procedure below.

Procedure

AUDIO	→	F•3	LISSAJOU SETUP	→	F•4	FORM: <u>X-Y</u> / MATRIX
-------	---	-----	----------------	---	-----	---------------------------

Settings

X-Y: R is assigned to the X-axis (horizontal), and L is assigned to the Y-axis (vertical).

MATRIX: The R and L axes are positioned at 45 ° angles to the X and Y axes.

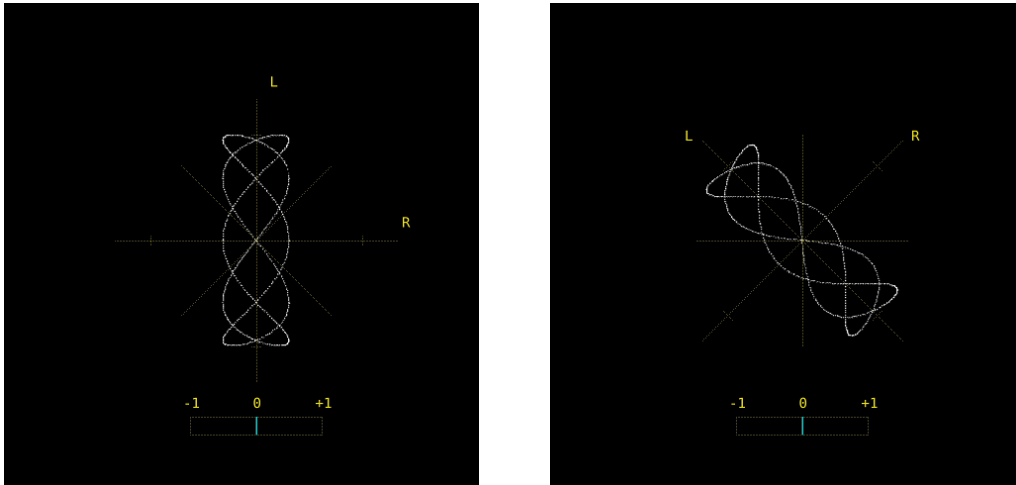

Figure 15-20 Selecting the scale display format

15. AUDIO DISPLAY

15.6.5 Setting the Lissajous Curve Gain

To select the Lissajous curve gain, follow the procedure below.

Procedure

AUDIO	→	F•3	LISSAJOU SETUP	→	F•5	AUTO GAIN: <u>ON</u> / OFF
-------	---	-----	----------------	---	-----	----------------------------

Settings

ON:	The gain is automatically adjusted so that the waveform fits the scale.
OFF:	The waveform is displayed with a fixed gain.

AUTO GAIN = ON

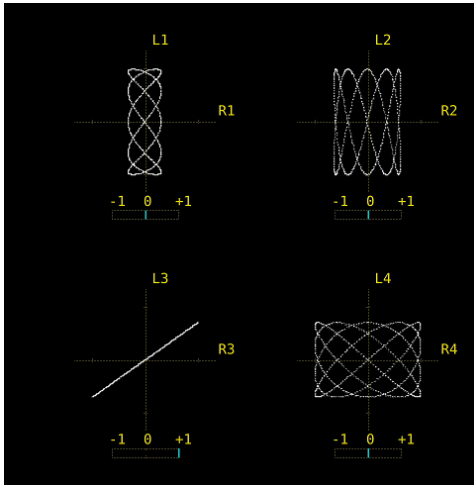

AUTO GAIN = OFF

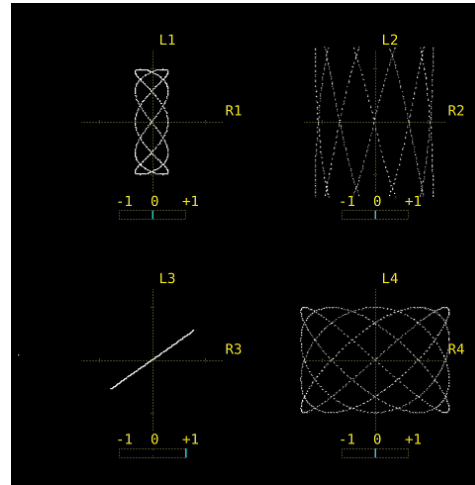

Figure 15-21 Setting the Lissajous curve gain

15. AUDIO DISPLAY

15.7 Surround Display (SER03)

To show the surround display, set **F•1** DISPLAY MODE on the AUDIO menu to SURROUND.
To configure the surround display settings, press **F•3** SURROUND SETUP. This setting is available when **F•1** DISPLAY MODE is set to SURROUND.

AUDIO → **F•1** DISPLAY MODE and select SURROUND → **F•3** SURROUND SETUP →

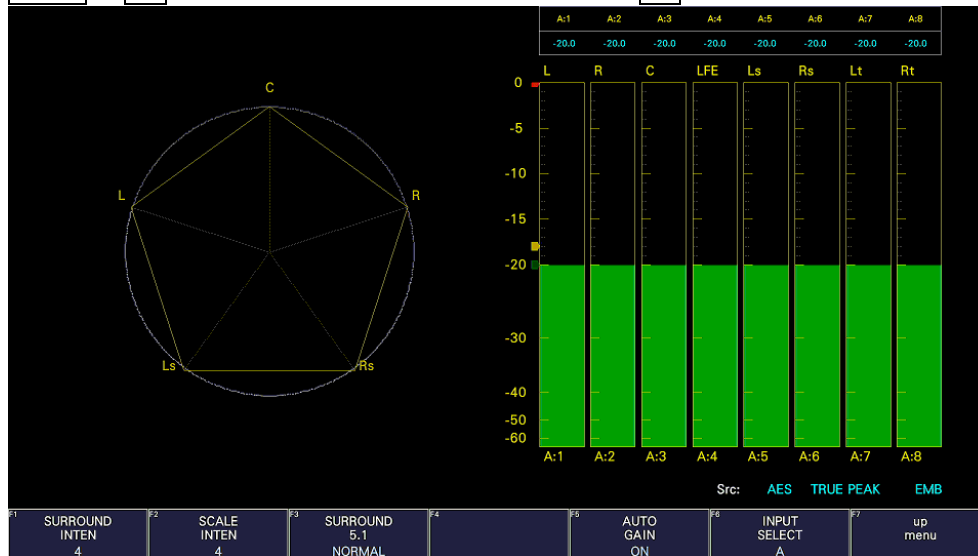

Figure 15-22 Surround display

15.7.1 Adjusting the Surround Waveform Intensity

To adjust the surround waveform intensity, follow the procedure below.
Press the function dial (**F•D**) to return the setting to its default value (4).

Procedure

AUDIO → **F•3** SURROUND SETUP → **F•1** SURROUND INTEN: -8 - 4 - 7

15.7.2 Adjusting the Scale Intensity

To adjust the intensity of the surround and meter scales, follow the procedure below.
Press the function dial (**F•D**) to return the setting to its default value (4).

Procedure

AUDIO → **F•3** SURROUND SETUP → **F•2** SCALE INTEN: -8 - 4 - 7

15. AUDIO DISPLAY

15.7.3 Selecting the Surround Display Format

To select the surround display format, follow the procedure below.

If adjacent channels (including Lch and Rch for PHANTOM) are of opposite phases, the scale between the channels is displayed in red.

Procedure

AUDIO	→	F•3	SURROUND SETUP	→	F•3	SURROUND 5.1: <u>NORMAL</u> / PHANTOM
-------	---	-----	----------------	---	-----	---------------------------------------

Settings

NORMAL: A waveform that combines Lch, Rch, Lsch, Rsch, and Cch (hard center) is displayed.

PHANTOM: A waveform that combines Lch, Rch, Lsch, Rsch, and phantom center and a Cch (hard center) waveform are displayed separately.

SURROUND 5.1 = NORMAL

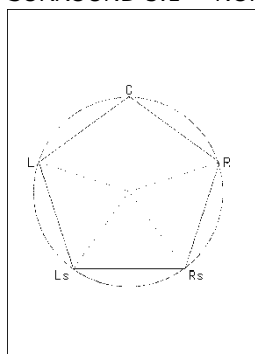

SURROUND 5.1 = PHANTOM

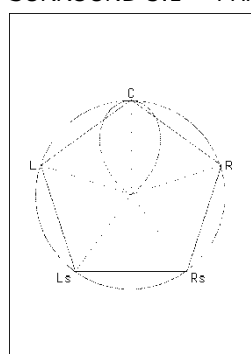

Figure 15-23 Selecting the surround display format

15.7.4 Setting the Surround Waveform Gain

To select the surround waveform gain, follow the procedure below.

Procedure

AUDIO	→	F•3	SURROUND SETUP	→	F•5	AUTO GAIN: <u>ON</u> / OFF
-------	---	-----	----------------	---	-----	----------------------------

Settings

ON: The gain is automatically adjusted so that the waveform fits the scale.

OFF: The waveform is displayed with a fixed gain.

15.8 Status Display (SER03)

To display the status, set **F•1** DISPLAY MODE on the AUDIO menu to STATUS.

To configure the status display settings, press **F•3** STATUS SETUP. This setting is available when **F•1** DISPLAY MODE is set to STATUS.

AUDIO → **F•1** DISPLAY MODE and select STATUS → **F•3** STATUS SETUP →

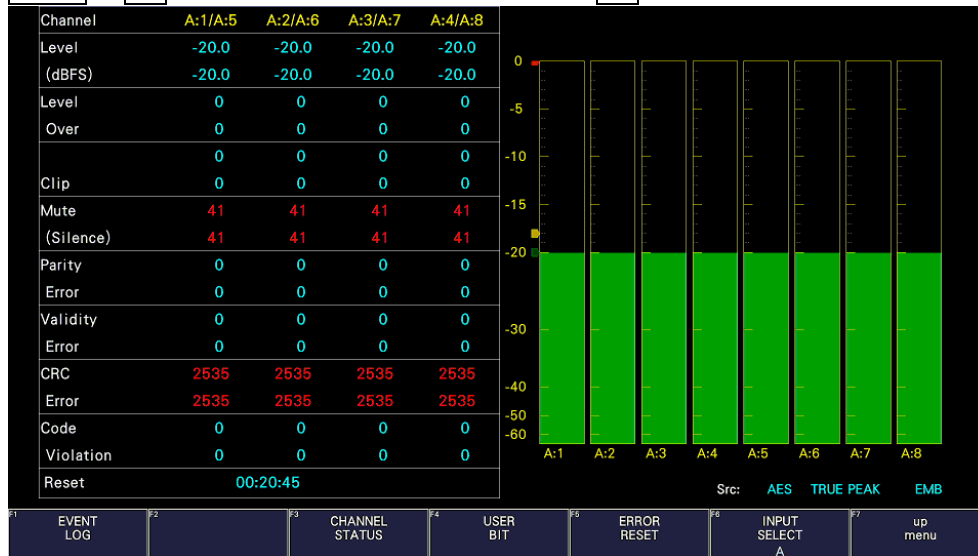

Figure 15-24 Status display

15.8.1 Status Screen Description

On the status display, the levels and the number of detected errors are displayed for the selected channels (up to 9999). Errors are only detected for the items that have been set to ON in section 15.3, “Configuring Error Detection Settings.”

- Channel

Displays the channel. Each item below this item is displayed in two lines. The top line corresponds to the channel to the left of the slash, and the bottom line corresponds to the channel to the right of the slash.

The order of channels can be changed in section 15.3, “Configuring Error Detection Settings.”

- Level (dBFS)

Displays the level numerically.

- Level Over

Displays the number of times the level is greater than equal to the OVER dBFS value set in section 15.5.4, “Setting the Reference Level.”

- Clip

Displays the number of times that a received signal exceeds the maximum signal value for the number of consecutive samples specified in section 15.3, “Configuring Error Detection Settings.”

15. AUDIO DISPLAY

- Mute (Silence)

Displays the number of times that a mute signal exceeding the duration specified in section 15.3, "Configuring Error Detection Settings" is received.

- Parity Error

Counts the number of times that the input signal's parity bit and the recalculated parity bit differ.

- Validity Error

Counts the number of times that the input signal's validity bit is 1.

- CRC Error

Counts the number of times that the CRC of the channel status bits and the calculated CRC are different.

- Code Violation

Counts the number of times that the state of the input signal's biphase modulation is abnormal.

- Reset

Displays the time that has elapsed since **AUDIO** → **F•3** STATUS SETUP → **F•5** ERROR RESET were pressed.

In Dolby signal measurements, Dolby CRC Error and Frame Location are displayed in addition to the number of detected errors.

ERROR or NOMAL to indicate whether there is an error are displayed in Dolby CRC Error.

Frame Location displays the header position and mode. During external audio measurements, H and mode are not displayed.

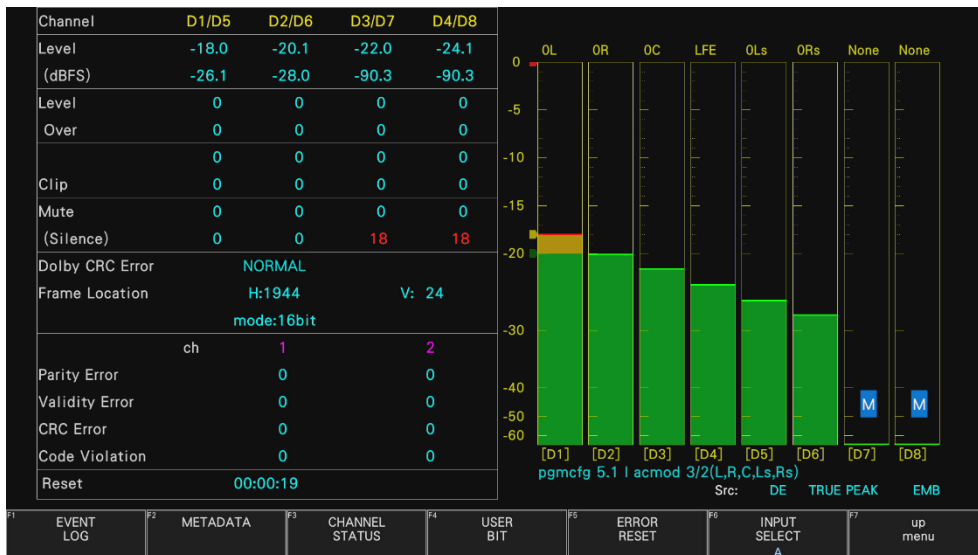

Figure 15-25 Status display (Dolby E)

15. AUDIO DISPLAY

15.8.2 Event Log Display

To view the event log, follow the procedure below.

This screen is the same as the event log screen of the status display. For details, see section 16.4, "Configuring Event Log Settings."

Procedure

AUDIO	→	F•3	STATUS SETUP	→	F•1	EVENT LOG
-------	---	-----	--------------	---	-----	-----------

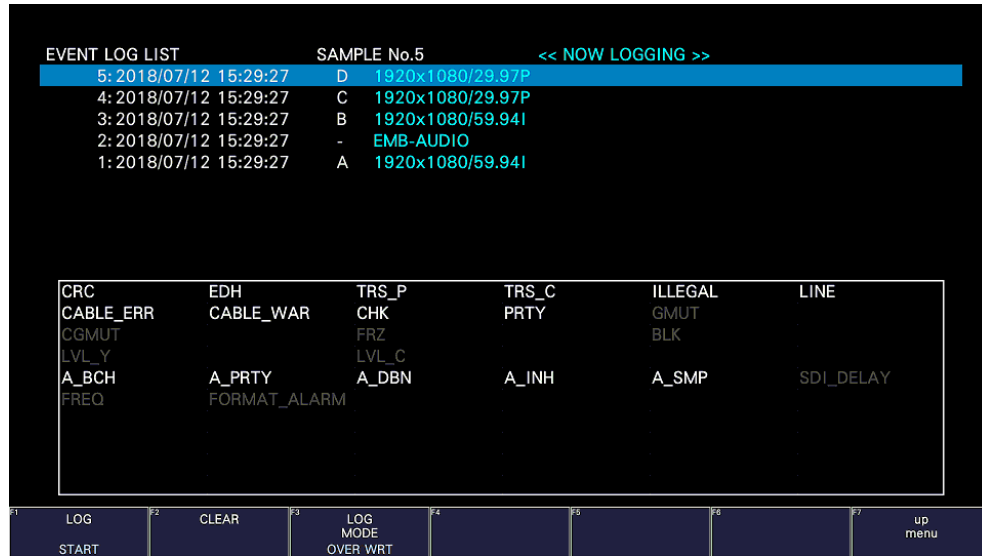

Figure 15-26 Event log display

15.8.3 Metadata Display (SER04)

- PCM metadata display

When Dolby on the TARGET tab is set to on during PCM measurement, to view the PCM metadata, follow the procedure below.

Procedure

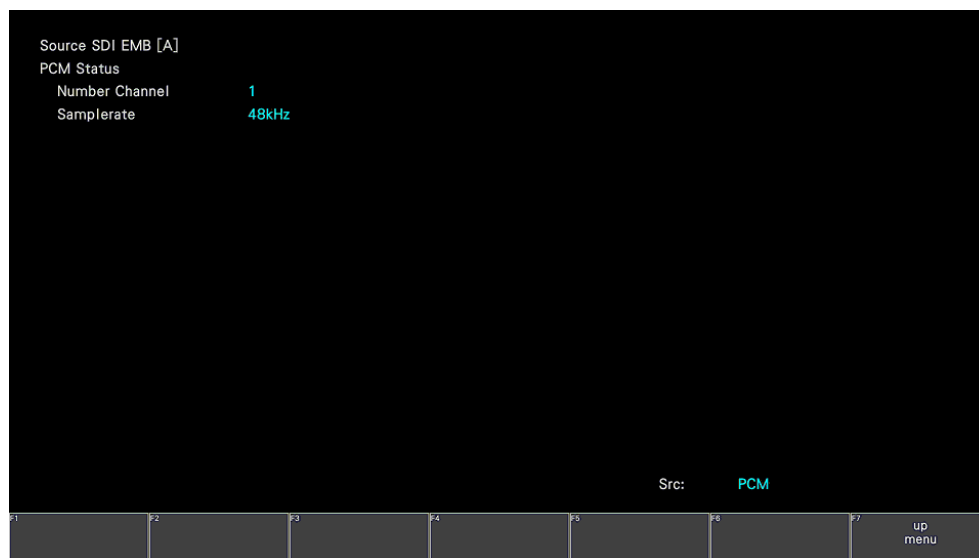

Figure 15-27 PCM metadata display

- Dolby E metadata display

During Dolby E measurement, to view the metadata of the selected program number, follow the procedure below.

To select the program number, press **F•1** DOLBY PROGRAM.

Procedure

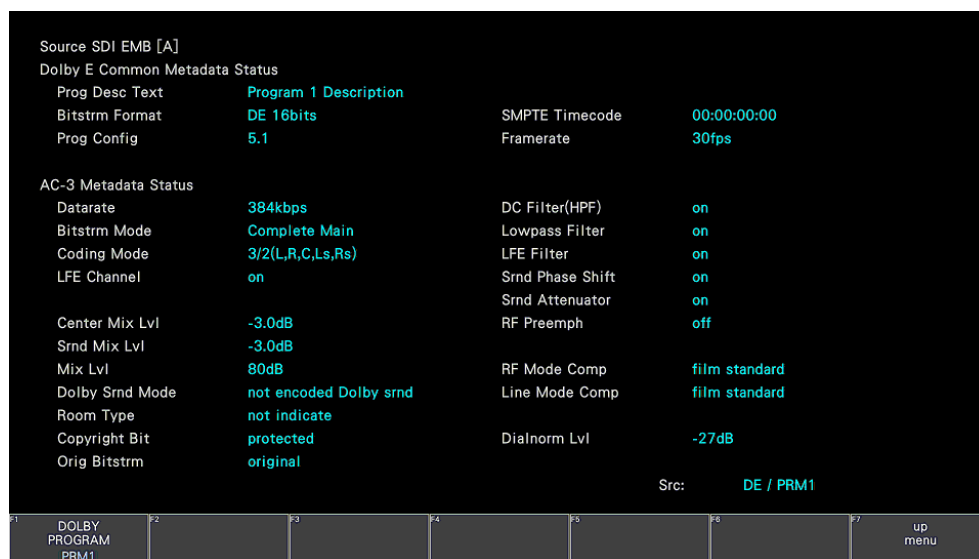

Figure 15-28 Dolby E metadata display

15. AUDIO DISPLAY

- Dolby E EBI metadata display

During Dolby E measurement, to view the EBI (Extended Bitstream Info) metadata of the selected program number, follow the procedure below.

To select the program number, press **F•1** DISPLAY PROGRAM.

Procedure

AUDIO	→	F•3	STATUS SETUP	→	F•2	METADATA	→	F•2	EBI METADATA
-------	---	-----	--------------	---	-----	----------	---	-----	--------------

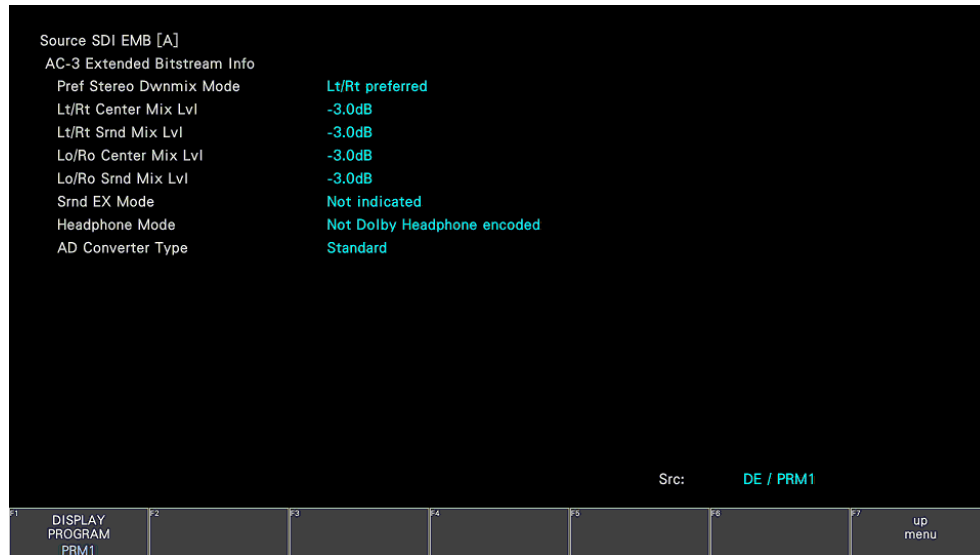

Figure 15-29 Dolby E EBI metadata display

- Dolby Digital metadata display

During Dolby Digital measurement, to view the metadata, follow the procedure below.

Procedure

AUDIO	→	F•3	STATUS SETUP	→	F•2	METADATA	→	F•1	DOLBY D METADATA
-------	---	-----	--------------	---	-----	----------	---	-----	------------------



Figure 15-30 Dolby Digital metadata display

15. AUDIO DISPLAY

- Dolby Digital EBI metadata display

During Dolby Digital measurement, to view the EBI (Extended Bitstream Info) metadata, follow the procedure below.

Procedure

AUDIO	→	F•3	STATUS SETUP	→	F•2	METADATA	→	F•2	EBI METADATA
-------	---	-----	--------------	---	-----	----------	---	-----	--------------

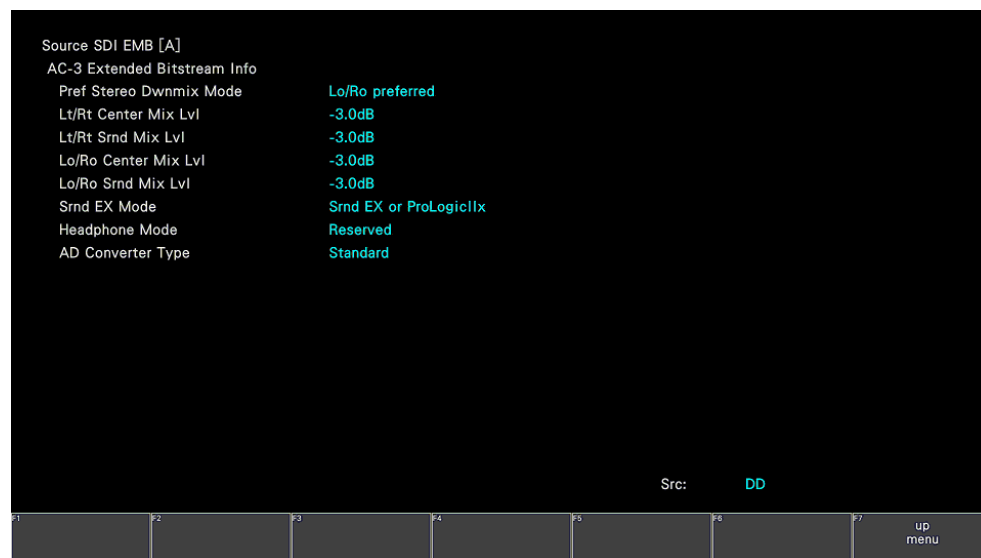

Figure 15-31 Dolby Digital EBI metadata display

- Dolby Digital Plus metadata display

During Dolby Digital Plus measurement, to view the metadata of the selected substream, follow the procedure below.

To select the substream, press **F•1** DOLBY SUBSTREAM.

Procedure

AUDIO	→	F•3	STATUS SETUP	→	F•2	METADATA	→	F•1	DOLBY D+ METADATA
-------	---	-----	--------------	---	-----	----------	---	-----	-------------------

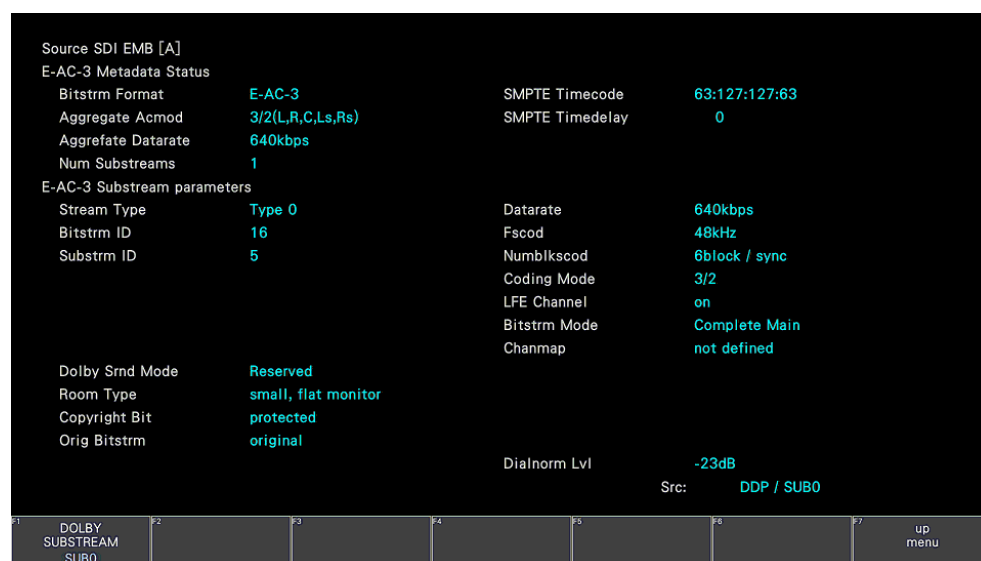

Figure 15-32 Dolby Digital Plus metadata display

15. AUDIO DISPLAY

- Dolby Digital Plus EBI metadata display

During Dolby Digital Plus measurement, to view the EBI (Extended Bitstream Info) metadata of the selected Substream, follow the procedure below.

To select the substream, press **F•1** DOLBY SUBSTREAM.

Procedure

AUDIO → **F•4** STATUS SETUP → **F•2** METADATA → **F•2** EBI METADATA

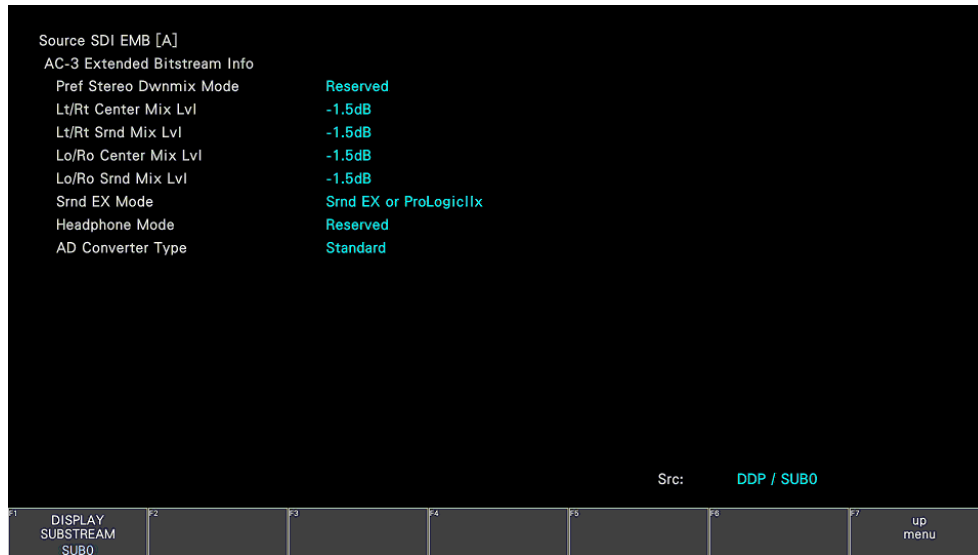

Figure 15-33 Dolby Digital Plus EBI metadata display

15. AUDIO DISPLAY

15.8.4 Channel Status Display

To display the status of the selected channel, follow the procedure below.

Use **F•1** DISPLAY CHANNEL to select the channel. You can also use **F•2** ALIGN to select the bit order.

Procedure

AUDIO → **F•3** STATUS SETUP → **F•3** CHANNEL STATUS

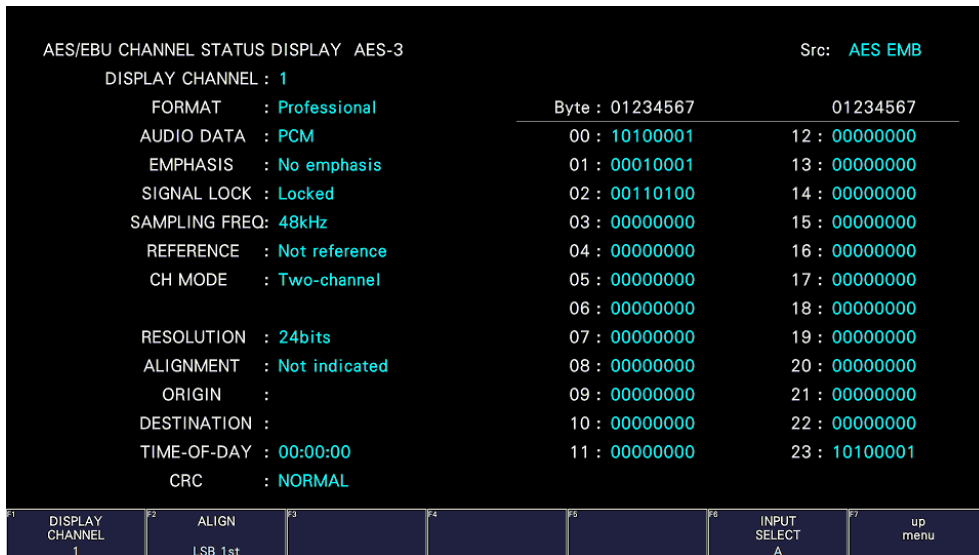

Figure 15-34 Channel status display

15. AUDIO DISPLAY

15.8.5 Displaying User Bits

To display the user bits of the selected channel, follow the procedure below.

Use **F•1** DISPLAY CHANNEL to select the channel. You can also use **F•2** ALIGN to select the bit order.

Procedure

AUDIO → **F•3** STATUS SETUP → **F•4** USER BIT

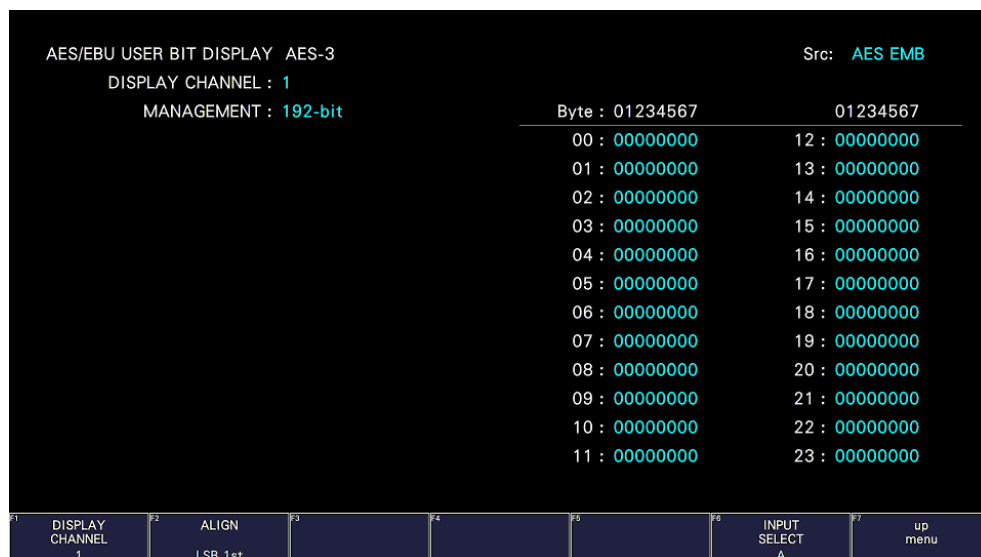

Figure 15-35 Displaying user bits

15.8.6 Resetting Errors

To reset the error counts that appear on the status display to 0, follow the procedure below. Also, the Reset indication at the lower left of the screen will be reset to 00:00:00.

Procedure

AUDIO → **F•3** STATUS SETUP → **F•5** ERROR RESET

15. AUDIO DISPLAY

15.9 Loudness Display (SER03)

On the loudness display, the loudness values are displayed on a chart, on a meter, and as values.

This setting is available when **F•1** DISPLAY MODE is set to LOUDNESS. Loudness display is not possible in 16-channel measurement or in simul mode during embedded audio measurement. To configure loudness display settings, press **F•3** LOUDNESS SETUP on the audio menu. This setting is available when **F•1** DISPLAY MODE is set to LOUDNESS.

15.9.1 Loudness Display Explanation

You can measure the loudness of one input or two inputs on the loudness display. To switch between one input and two inputs, press **F•5** LOUDNESS SETTING, and use the CHANNEL SUB tab.

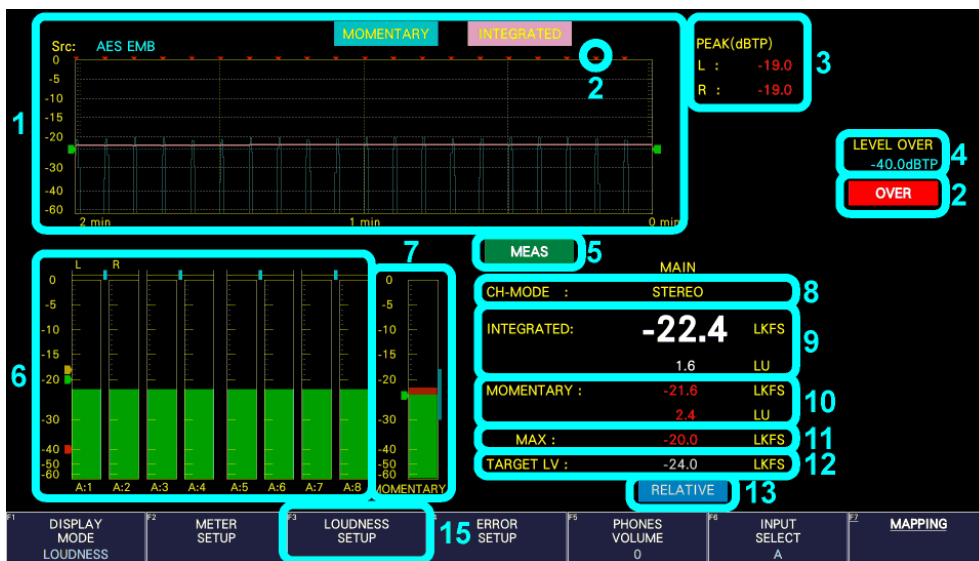

Figure 15-36 One input (MAIN) loudness display

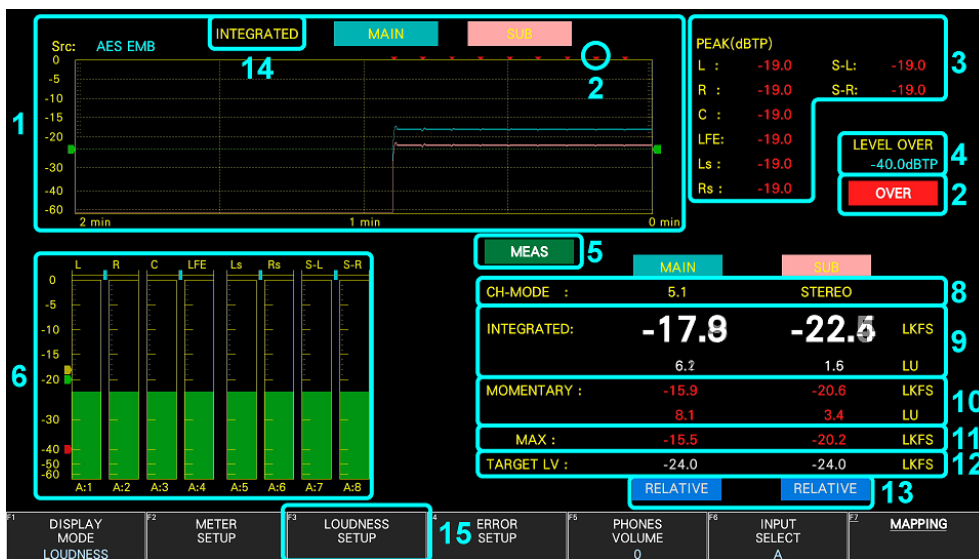

Figure 15-37 Two input (MAIN and SUB) loudness display

15. AUDIO DISPLAY

1 Loudness Chart Display

One of the following values that you specified with **F•5** LOUDNESS SETTING is displayed on a time-based chart.

- Integrated loudness and momentary loudness of one input (MAIN)
- Integrated loudness and short-term loudness of one input (MAIN)
- Integrated loudness of two inputs (MAIN and SUB)
- Momentary loudness of two inputs (MAIN and SUB)
- Short-term loudness of two inputs (MAIN and SUB)

You can press **F•1** PERIOD to change the measurement time. You can press **F•4** MAG to expand the level scale. The green line indicates the target level.

To start measuring, set **F•3** MEASURE to START. You can also use pin 9 (/P8) of the remote connector or a time code.

To clear the loudness chart, press **F•2** CHART CLEAR. You can also use pin 8 (/P7) of the remote connector.

[See also] 15.9.6, "Configuring Loudness Settings," and 18, "Remote Control"

2 OVER

If dBTP Over Mark is set to ON on the LOUDNESS2 tab that appears when the peak level of a channel is greater than or equal to the level specified by OVER dBFS, a red ▼ is displayed at the top of the chart. An OVER mark is also displayed.

Neither mark is displayed when Level Over under ERROR SETUP is set to OFF.

[See also] OVER dBFS →15.5.4, "Setting the Reference Level."

ERROR SETUP →15.3, "Configuring Error Detection Settings."

3 PEAK(dBTP)

This displays the peak levels of the channels that have been assigned on the CHANNEL MAIN, CHANNEL SUB tab. You can press **F•2** CHART CLEAR to clear the peak levels.

The values are normally displayed in white, but when a value is greater than or equal to the value specified by OVER dBFS, it is displayed in red.

[See also] OVER dBFS →15.5.4, "Setting the Reference Level."

4 LEVEL OVER

The level specified by OVER dBFS is displayed when Level Over under ERROR SETUP is set to ON and dBTP Over Mark is set to ON on the LOUDNESS SETTING tab.

[See also] OVER dBFS →15.5.4, "Setting the Reference Level."

ERROR SETUP →15.3, "Configuring Error Detection Settings."

5 MEAS / STOP / READY

"MEAS" is displayed during loudness measurement, and "STOP" is displayed when measurement is stopped, "READY" is displayed when the instrument is standing by.

6 Meter Display

The levels of the channels that you selected in section 15.1, "Setting the Signals to Measure" are displayed on a meter. In addition, correlation meters of adjacent channels are displayed at the top area of the meter. The correlation meter indicates the phase difference between the two signals. The right edge indicates in-phase, the left edge indicates 180 ° out of phase, and the center indicates no correlation.

15. AUDIO DISPLAY

7 Loudness Meter Display (only for one input measurement)

The short-term loudness or the momentary loudness selected using Loudness Response on the LOUDNESS2 tab is displayed using meters. The level is normally displayed in green, but it is displayed in red if it exceeds the target level.

8 CH-MODE

This displays the channel mode that was selected on the CHANNEL MAIN, CHANNEL SUB tab.

9 INTEGRATED

The integrated loudness is displayed as values. The top value is an absolute value. The bottom value is a relative value with the target level as the reference. These values are normally displayed in white, but they are displayed in red when:

- The measurement mode is ARIB or EBU (LIVE ON) and the loudness level is outside the range defined by the target level ± 1 (LU).
- The measurement mode is EBU (LIVE OFF) and the loudness level is outside the range defined by the target level ± 0.5 (LU).
- The measurement mode is ATSC and the loudness level is outside the range defined by the target level ± 2 (LK).

10 SHORTTERM / MOMENTARY

The short-term loudness or the momentary loudness selected using Loudness Response on the LOUDNESS2 tab is displayed as values.

The top value is an absolute value. The bottom value is a relative value with the target level as the reference.

11 MAX

The maximum value of the short-term loudness or momentary loudness selected using Loudness Response on the LOUDNESS2 tab is displayed as a value.

12 TARGET LV

This displays the target level. The target level varies according to the measurement mode as shown below.

- When the measurement mode is not EBU: -24.0 (LKFS)
- When the measurement mode is EBU: -23.0 (LUFS)

13 RELATIVE

This indication appears when the input signal is applicable for relative gating. This is displayed when Relative Gating Lamp is set to ON on the LOUDNESS2 tab.

14 INTEGRATED / SHORTTERM / MOMENTARY (only for two input measurement)

This displays the loudness type that was selected on the LOUDNESS SETTING tab Chart Setting.

15. AUDIO DISPLAY

15 LOUDNESS SETUP

To configure loudness display settings, press **F•3** LOUDNESS SETUP on the audio menu. This setting is available when **F•1** DISPLAY MODE is set to LOUDNESS.



Figure 15-38 LOUDNESS SETUP menu

15.9.2 Selecting the Measurement Time

To select the measurement time, follow the procedure below.

Procedure

AUDIO → **F•3** LOUDNESS SETUP → **F•1** PERIOD: 2MIN / 10MIN / 30MIN / 1HOUR / 2HOUR / 6HOUR / 12HOUR / 24HOUR

15.9.3 Clearing the Loudness Measurement

To clear the loudness chart, peak level, and numeric displays, follow the procedure below.

Procedure

AUDIO → **F•3** LOUDNESS SETUP → **F•2** CHART CLEAR

15.9.4 Starting and Stopping Measurements

To start and stop measurements, follow the procedure below. When measurements are being performed, "MEAS" is displayed in the center of the screen. When measurements are stopped, "STOP" is displayed. "READY" is displayed when measurement is in standby. This menu item does not appear when Trigger on the LOUDNESS2 tab is set to REMOTE.

Procedure

AUDIO → **F•3** LOUDNESS SETUP → **F•3** MEASURE: STOP / START

15.9.5 Selecting the Scale

To select the loudness chart display scale, follow the procedure below.

Procedure

AUDIO → **F•3** LOUDNESS SETUP → **F•4** MAG: OFF / ON

Settings

OFF: The target level is displayed on the scale that you selected with DYNAMIC RANGE on the METER SETUP menu.

ON: The target level is displayed on a scale that has a full scale ranging from -18 to +9 (LK/LU).

15. AUDIO DISPLAY

15.9.6 Configuring Loudness Settings

To configure loudness settings, follow the procedure below.

Procedure

AUDIO → F.3 LOUDNESS SETUP → F.5 LOUDNESS SETTING

• LOUDNESS1 Tab

AUDIO → F.3 LOUDNESS SETUP → F.5 LOUDNESS SETTING

→ F.2 PREV TAB or F.3 NEXT TAB →



Figure 15-39 LOUDNESS1 tab

• Measure Mode

Select the measurement mode.

BS1770 / ARIB / EBU / ATSC / CUSTOM

Depending on the measurement mode, the parameters vary as shown below.

Table 15-3 Selecting the measurement mode

	Measure Mode				
	BS1770	ARIB	EBU	ATSC	CUSTOM
Corresponding Standard	ITU-R BS.1770	ARIB TR-B32	EBU R128	ATSC A/85	-
Live Mode	-	-	OFF	ON	-
Target Level	-24.0 [LKFS]	-24.0 [LKFS]	-23.0 [LUFS]	-24.0 [LKFS]	-25.0 to -23.0 [LKFS]
Block Size (ms)	400	400	400	400	400
Overlap Size (%)	75	75	75	0	75
Absolute Gating	-70 [LKFS]	-70 [LKFS]	-70 [LUFS]	-	-70 [LKFS]
Relative Gating	-10 [LKFS]	-10 [LKFS]	-10 [LUFS]	-	-10 [LKFS]

15. AUDIO DISPLAY

- Live Mode

When Measure Mode is set to EBU, set Live Mode on and off. When this is set to OFF, Target Level Tolerance is ± 1.0 LU, and when this is set to ON, it is ± 0.5 LU.

OFF / ON

- LFE Gain

When Measure Mode is set to CUSTOM on the CHANNEL MAIN tab, select whether to measure LFEch. When this is set to ON, you can set the LFEch gain to a value from 0 to 10.

OFF / ON

- ShortTerm Loudness

Set the time that is used to calculate the short-term loudness, When Measure Mode is set to CUSTOM.

200 - 3000 - 10000

- Momentary Loudness

Set the time that is used to calculate the momentary loudness, When Measure Mode is set to CUSTOM.

200 - 400 - 10000

- LOUDNESS2 Tab

AUDIO → F•3 LOUDNESS SETUP → F•5 LOUDNESS SETTING
 → F•2 PREV TAB or F•3 NEXT TAB →

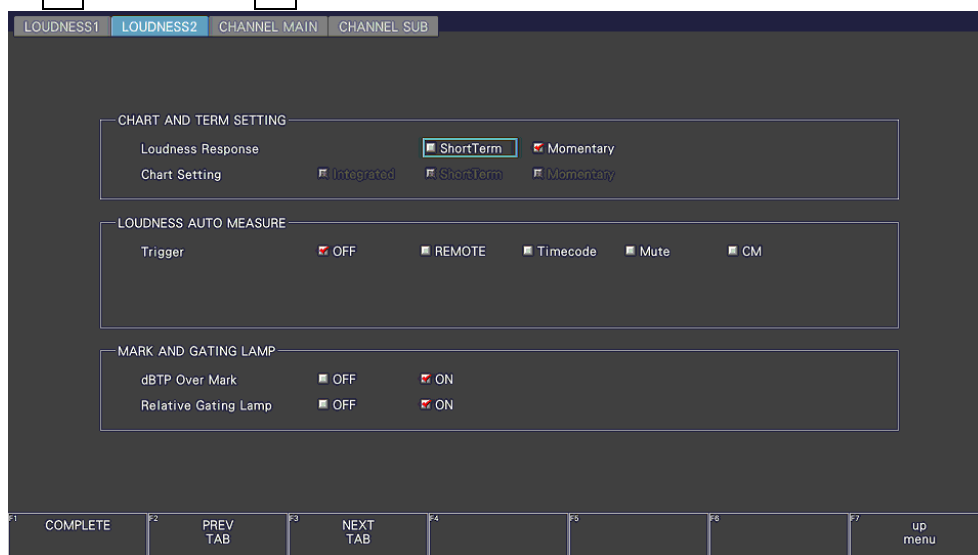

Figure 15-40 LOUDNESS2 tab

- Loudness Response

Select the response model.

When MODE on the CHANNEL SUB tab is set to MONO (ARIB) or STEREO, setting Loudness Response to ShortTerm also sets Chart Setting to ShortTerm, and setting

15. AUDIO DISPLAY

Loudness Response to Momentary also sets Chart Setting to Momentary.

ShortTerm / Momentary

- Chart Setting

When MODE on the CHANNEL SUB tab is set to MONO (ARIB) or STEREO, select the type of loudness to display on the loudness chart.

Setting Chart Setting to ShortTerm also sets Loudness Response to ShortTerm, and setting Chart Setting to Momentary also sets Loudness Response to Momentary.

Integrated / ShortTerm / Momentary

- Trigger

Select the automatic loudness measurement mode from the available settings below.

OFF:	Automatic measurement is disabled. You must set the loudness measurement on the LOUDNESS SETUP menu.
REMOTE:	Measurement start, stop, and clear are executed through the remote control connector. See chapter 18, "REMOTE CONTROL." You have to press [SYS] → [F•2] SYSTEM SETUP, and then set Remote Select to Recall and Loudness on the REMOTE SETUP tab.
Timecode:	Measurement start and stop are executed on the basis of the time codes embedded in the SDI signals. Set Start Time and End Time first, and then set [F•3] MEASURE on the LOUDNESS SETUP menu to START. "STOP" in the center of the screen changes to "READY." When the time specified by Start Time arrives, measurement starts automatically. You need to select the time code using [SYS] → [F•2] SYSTEM SETUP → CAPTURE&DISPLAY tab → Time.
Mute:	Measurement start, stop, and clear and storage to USB memory are executed through input signal level. The loudness of the CM material is measured. See "• When Mute is selected."
CM:	Measurement start, stop, and clear and storage to USB memory are executed through input signal level and frequency. The loudness of the CM material is measured. See "• When CM is selected."

15. AUDIO DISPLAY

If you select Mute or CM; connect a USB memory device, on the LOUDNESS SETUP menu, press **F•3** MEASURE to select START; and then input the CM material. "READY" appears in the center of the display.

- When Mute is selected

When audio at -20 dBFS or more is detected, the loudness measurement is cleared at the end of this sound. Loudness measurement starts 1 second after the loudness measurement is cleared. "MEAS" appears in the center of the display.

Loudness measurement stops after 3 seconds of detecting silence after the end of the CM, and loudness data is saved to the USB memory device. "READY" appears in the center of the display.

- When CM is selected

When 1 kHz audio at -20 dBFS or more is detected, the loudness measurement is cleared at the end of this sound. Loudness measurement starts 0.1 second after the loudness measurement is cleared. "MEAS" appears in the center of the display.

Loudness measurement stops after 0.5 seconds of detecting silence after the end of the CM, and loudness data is saved to the USB memory device. "READY" appears in the center of the display.

For details on the loudness data, see section 15.9.7, "Saving to a USB Memory Device."

You can measure multiple CM materials in succession by applying subsequent CM materials.

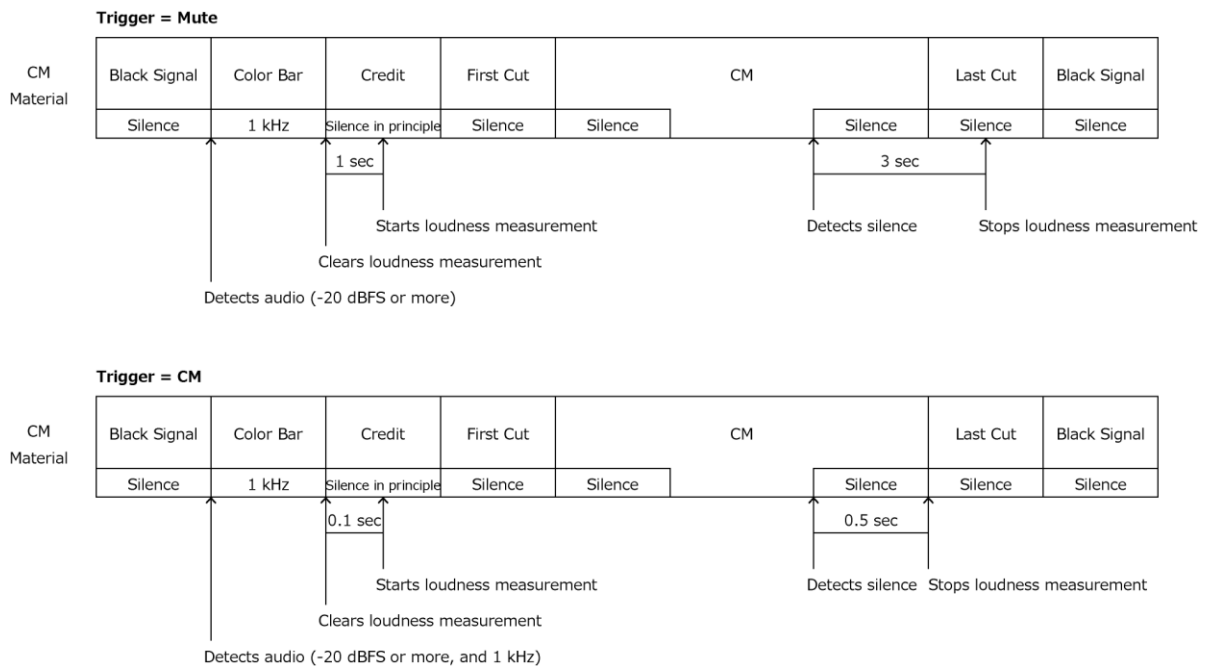

Figure 15-41 Mute, CM explanation

15. AUDIO DISPLAY

- dBTP Over Mark

Select whether to display a ▼ mark and the “OVER” mark when the peak level of a channel is greater than or equal to the level specified by OVER dBFS.

Neither mark is displayed when Level Over under ERROR SETUP is set to OFF.

[See also] OVER dBFS →15.5.4, “Setting the Reference Level.”

ERROR SETUP →15.3, “Configuring Error Detection Settings.”

OFF / ON

- Relative Gating Lamp

Select whether to display “R” when the input signal is applicable for relative gating.

OFF / ON

- CHANNEL MAIN Tab

AUDIO → F•3 LOUDNESS SETUP → F•5 LOUDNESS SETTING

→ F•2 PREV TAB or F•3 NEXT TAB →



Figure 15-42 CHANNEL MAIN tab

- MODE

Select the main loudness measurement channel.

MONO(ARIB): The channel that you select for L-Rch is measured.

STEREO: The channels that you select for Lch and Rch are measured.

5.1: The channels that you select for Lch, Rch, Cch, LFEch, Lsch, and Rsch are measured.

CUSTOM: The channels that you select for Lch, Rch, Cch, LFEch, Lsch, and Rsch are measured. N.C. can be selected during embedded audio measurement. Channels set to N.C. are not measured.

15. AUDIO DISPLAY

- CHANNEL SUB Tab

AUDIO → F.3 LOUDNESS SETUP → F.5 LOUDNESS SETTING
→ F.2 PREV TAB or F.3 NEXT TAB →

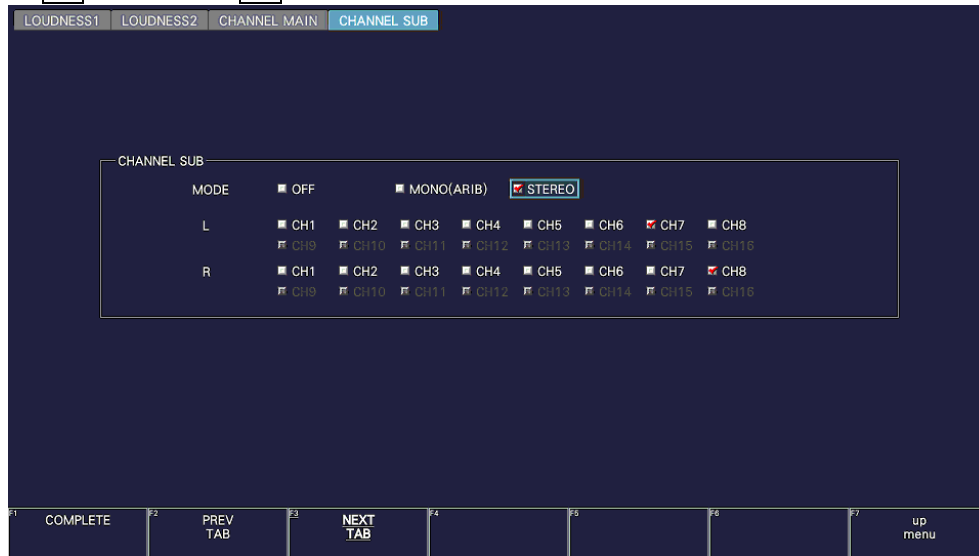

Figure 15-43 CHANNEL SUB tab

- MODE

Select the sub loudness measurement channel.

OFF:	Sub loudness is not measured.
MONO(ARIB):	The channel that you select for L-Rch is measured.
STEREO:	The channels that you select for Lch and Rch are measured.

15. AUDIO DISPLAY

15.9.7 Saving to a USB Memory Device

You can save the loudness data to a USB memory device as a .csv file and as a text file. To save a file with a name that you specify, follow the procedure below.

1. Connect a USB memory device to the instrument.
2. Press **F•6** USB MEMORY.

The file list display appears.

This setting appears when a USB memory device is connected to the instrument.

No.	Filename	Date&Time	Size(byte)
1	20160607153833.csv	2016/06/07 15:38:33	16,155
2	20160607153833.txt	2016/06/07 15:38:33	873

Disk Size: 4,001,902,592 Byte
Free Size: 3,654,942,720 Byte

Loudness Store File Name
.csv

F1 AUTO FILENAME ON F2 F3 STORE F4 FILE DELETE F5 F6 F7 up menu

Figure 15-44 File list display

3. Set **F•1** AUTO FILENAME to OFF.
4. Press **F•2** NAME INPUT.

The file name input display appears.

0	1	2	3	4	5	6	7	8	9
A	B	C	D	E	F	G	H	I	J
K	L	M	N	O	P	Q	R	S	T
U	V	W	X	Y	Z	_			

[F.D_NOB] = CHAR SELECT, [F.D_PUSH] = CHAR SET & Function Key Edit

LOUDNESS Store File Name
.csv

F1 CLEAR ALL F2 DELETE F3 F4 <=> F5 >=> F6 CHAR SET F7 up menu

Figure 15-45 File name input display

15. AUDIO DISPLAY

5. Enter a file name using up to 14 characters.

The key operations that you can perform on the file name input display are as follows:

F•1	CLEAR ALL	: Deletes all characters
F•2	DELETE	: Deletes the character at the cursor
F•4	<=	: Moves the cursor to the left
F•5	=>	: Moves the cursor to the right
F•6	CHAR SET	: Enters the character
Function Dial (F•D)		: Turn to select a character, and press to enter the character.

You can copy the file name of an already saved file. To copy a file name, move the cursor to the file in the file list whose name you want to copy, and then press the function dial (F•D).

6. Press **F•7** up menu.
7. Press **F•3** STORE.

When the message "Saving file - Please wait." disappears, the file has been successfully saved.

If a file with the same name already exists on the USB memory device, an overwrite confirmation menu appears. To overwrite the current file, press **F•1** OVER WR YES. To cancel the save operation, press **F•3** OVER WR NO.

- Deleting a Loudness Data

To delete a loudness data that has been saved to the USB memory device, select the log file on the file list display, and then press **F•4** FILE DELETE. To delete the file, press **F•1** DELETE YES. To cancel the delete operation, press **F•3** DELETE NO.

- Automatic File Name Generation

If you set **F•1** AUTO FILENAME to ON, the file name will be generated automatically in the format "YYYYMMDDhhmmss" when you save the file. In this situation, **F•2** NAME INPUT is not displayed.

- USB Memory Device Folder Structure

Loudness data is saved in the LOUDNESS folder.

```
└─ USB memory device
   └─ LV5600_USER or LV7600_USER
      └─ LOUDNESS
         └─ YYYYMMDDhhmmss.csv
            └─ YYYYMMDDhhmmss.txt
```

- Loudness Data Explanation

In txt data, the contents set using **F•5** LOUDNESS SETTING and integrated loudness values are stored. Judgment ([OK] or [NG]) on the basis of THRESHOLD is also stored.

In csv data, the current time, timecodes, main gating block loudness values, and sub gating block loudness values are stored. Data values of about 10 points are stored per second.

15. AUDIO DISPLAY

txt data example

```

2012/07/12 10:32:31
<< SETTING DATA and RESULT >>

-----
LOUDNESS SETTING
-----

MEASURE MODE   : ARIB

TARGET LEVEL   : -24.0 LKFS
THRESHOLD      : -25.0 ~ -23.0 LKFS

BLOCK SIZE     : 400 msec
OVERLAP SIZE   : 75 %
ABS GATING LV  : -70.0 LKFS
REL GATING LV  : -10.0 LKFS

LFE GAIN       : OFF

-----
LOUDNESS RESPONSE
-----

RESPONSE       : MOMENTARY
AVERAGE TIME   : 400 (msec)
    
```

csv data example

```

2012/7/12 10:32
10:30:29 0:09:34 -22.6 -
27.2
10:30:29 0:09:34 -18.9 -
23.6
10:30:30 0:09:35 -17 -
21.6
10:30:30 0:09:35 -15.6 -
20.3
10:30:30 0:09:35 -15.4 -20
10:30:30 0:09:35 -15.4 -20
10:30:30 0:09:35 -15.4 -20
10:30:30 0:09:35 -15.4 -20
10:30:30 0:09:35 -15.4 -20
10:30:30 0:09:35 -14.9 -
19.5
10:30:30 0:09:35 -14.4 -19
10:30:30 0:09:35 -13.9 -
18.5
10:30:31 0:09:36 -13.5 -
18.1
10:30:31 0:09:36 -13.4 -18
10:30:31 0:09:36 -13.6 -
18.3
10:30:31 0:09:36 -15 -
19.6
10:30:31 0:09:36 -16.9 -
21.6
10:30:31 0:09:36 -20.6 -
25.2
10:30:31 0:09:36 -100 -100
10:30:31 0:09:36 -100 -100
10:30:31 0:09:36 -22.6 -
27.3
10:30:31 0:09:36 -18.9 -
23.6
10:30:31 0:09:36 -17 -
21.6
10:30:32 0:09:37 -15.5 -
20.1
10:30:32 0:09:37 -14.6 -
19.3
    
```

⋮

```

SUB MODE : STEREO

SUB - L  : CH 7
SUB - R  : CH 8

-----
PEAK HOLD ( dBTP )
-----

L       : -16.9
R       : -16.9
C       : -16.9
    
```

⋮

```

10:30:33 0:09:38 -20.6 -
25.2
10:30:33 0:09:38 -100 -100
10:30:34 0:09:39 -22.6 -
27.3
10:30:34 0:09:39 -19 -
23.6
10:30:34 0:09:39 -17 -
21.6
10:30:34 0:09:39 -15.6 -
20.3
10:30:34 0:09:39 -14.9 -
    
```

15. AUDIO DISPLAY

LFE	:	-16.9	
Ls	:	-16.9	
Rs	:	-16.9	
S - L	:	-16.9	
S - R	:	-16.9	

RESULT			

MAIN LOUDNESS	:	-15.8 (LKFS)	/ 8.2 (LU)
[NG]			
SUB LOUDNESS	:	-20.4 (LKFS)	/ 3.6 (LU)
[NG]			

19.5			
10:30:34	0:09:39	-14.4	-19
10:30:34	0:09:39	-13.9	-
18.5			
10:30:34	0:09:39	-13.7	-
18.4			
10:30:34	0:09:39	-15	-
19.6			
10:30:34	0:09:39	-16.9	-
21.6			
10:30:34	0:09:39	-20.6	-
25.2			
10:30:35	0:09:40	-22.6	-
27.3			
10:30:35	0:09:40	-19	-
23.6			
10:30:35	0:09:40	-17	-
21.6			
10:30:35	0:09:40	-15.2	-
19.8			
10:30:35	0:09:40	-14.4	-19
10:30:35	0:09:40	-14.2	-
18.8			
10:30:35	0:09:40	-15.1	-
19.8			
10:30:35	0:09:40	-16.9	-
21.6			
10:30:35	0:09:40	-19.8	-
24.4			
10:30:35	0:09:40	-20.4	-25
10:30:36	0:09:41	-17.9	-
22.5			
10:30:36	0:09:41	-16.1	-
20.7			

16. STATUS DISPLAY

To display the status, press STATUS.

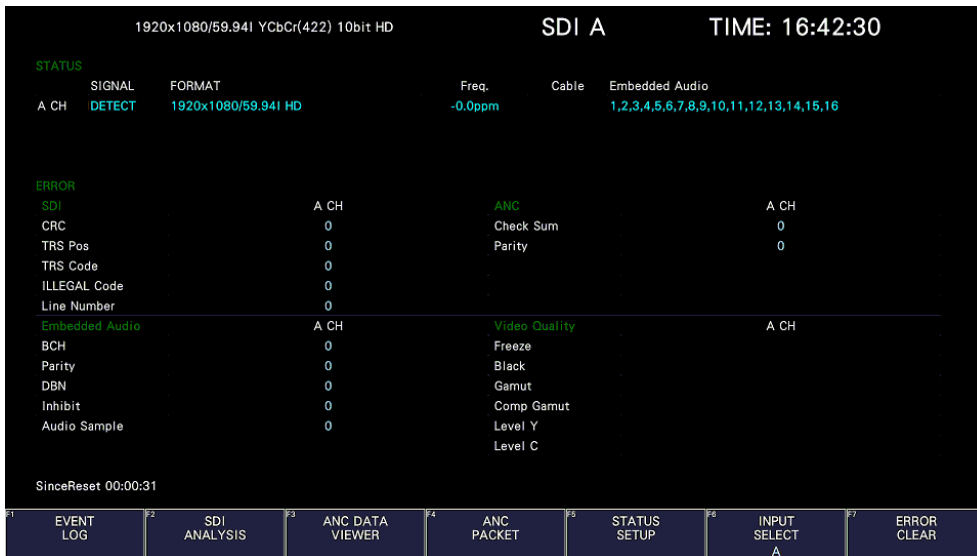

Figure 16-1 Status display

16.1 Status Screen Description

- SIGNAL

If the instrument is receiving an SDI signal, "DETECT" is displayed. Otherwise, "NO SIGNAL" is displayed.

If "NO SIGNAL" is displayed, the following items are not displayed.

- FORMAT/SUB IMAGE FORMAT

The input signal format is indicated. It is normally displayed in light blue, but if the input is not appropriate, it turns red.

For 4K, the sub image format 1920(2048) × 1080 is displayed.

- Freq

The sampling frequency deviation is displayed.

Normally, this is displayed in light blue. If Frequency Error on the ERROR SETUP1 tab is set to ON, the color changes to red when ± 10 ppm is exceeded.

The display range is "<-100 ppm, -100 to +100 ppm, >+100 ppm," and the accuracy is ± 2 ppm.

This is not displayed for IP input.

[See also] ERROR SETUP1 tab → section 16.2.1, "Error Setup 1"

16. STATUS DISPLAY

- Cable

The input signal attenuation is converted into a cable length that you selected and displayed.

Normally the value is displayed in light blue, but by setting Cable Error on the ERROR SETUP1 tab to ON, if the value exceeds the specified Warning value, it will change to yellow. If the value exceeds the Error value, it will change to red.

The display range, accuracy, and resolution are shown below.

This is not displayed for IP input.

[See also] ERROR SETUP1 tab → section 16.2.1, "Error Setup 1"

- Display Range

12G	< 10 m, 10 to 80 m, > 80 m	(10 m steps)
3G	< 10 m, 10 to 100 m, > 100 m	(10 m steps)
HD	< 10 m, 10 to 130 m, > 130 m	(10 m steps)
SD	< 50 m, 50 to 200 m, > 200 m	(10 m steps)

- Accuracy

12G, 3G, HD	±20 m
SD	±30 m

- Resolution 10 m

- Embedded Audio

The channels of the audio packets embedded in the input signal are displayed.

If the input signal is 3G-B-DL, only stream 1 is displayed. (When measuring 3G-B DS, stream 2 is also displayed.)

- ERROR

The counts of the errors for the items whose detection setting was set to ON with F•5 STATUS SETUP are displayed. Errors are counted once per second or once per field. The maximum number of errors that can be counted is 999999.

Switching video formats or input channels may cause disturbances in the signal that will cause errors to be detected.

- CRC (other than SD)

An error is counted when the CRC embedded in the input signal is different from the CRC that the instrument calculates.

- EDH (SD only)

An error is counted when the EDH packet contains an ancillary data error flag, an active picture error flag, or a full-field error flag and when the CRC in the EDH packet is different from the CRC that the instrument calculates from the video data.

16. STATUS DISPLAY

- TRS Pos

Input signal TRS (Timing Reference Signal) errors are displayed.

An error is counted when the position of the header word (3FFh, 000h, 000h) of EAV (End of Active Video) and SAV (Start of Active Video) is not correct or when the F, V, or H TRS protection bit is outside the video specifications (such as when the blanking period is different).

- TRS Code

Input signal TRS (Timing Reference Signal) protection bit errors are displayed.

An error is counted when the correspondence between F, V, and H in the protection bits (XYZ) of EAV (End of Active Video) and SAV (Start of Active Video) and error correction flags P3, P2, P1, and P0 is outside the video specifications.

- ILLEGAL Code

An error is counted when the input signal data is outside the timing reference signal (TRS) range or the range specified for the ancillary data flag (ADF) and "000h to 003h" or "3FCh to 3FFh" is detected.

In SDI signals, 000h to 003h and 3FCh to 3FFh (expressed as 10 bit data) are designed to be used as timing reference signals and ancillary data flags, they cannot be used as video signal data or ancillary data. An error is counted when data other than timing reference signal or ancillary data flag is present in this area.

- Line Number (other than SD)

An error is counted when the line number that is embedded in the input signal does not match the line number that has been counted by the instrument.

- BCH (other than SD)

The instrument counts the errors in the BCH code in the input signal's embedded audio.

- Parity (other than SD)

The instrument counts the parity errors in the input signal's embedded audio.

- DBN

The instrument counts the continuity errors in the input signal's embedded audio.

Embedded audio packets contain data block number words (DBN), which indicate packet continuity. A serial number between 1 and 255 is assigned to each packet. An error is counted when this DBN is not continuous between packets.

If DBN does not repeat the values from 1 and 255 and is fixed to 0, it is not detected as an error.

16. STATUS DISPLAY

- Inhibit

An error is counted when embedded audio packets are found in lines where they should not be embedded. The embedding inhibit lines are as follows.

However, for 3G-B-DL 60p, 59.94p, 50p, 48p, and 47.95p, the transmission scanning mode is interlace. For 12G and 6G, the line numbers are those of the sub images divided into the HD and 3G data structure.

Table 16-1 Embedding inhibit lines

Format		Transmission Scanning Mode	
		Progressive	Interlace
12G/6G	3840(4096)×2160	Line 8	-
HD/3G	1280×720	Line 8	-
	1920×1080	Line 8	Lines 8, 570
SD	720×487	-	Lines 11, 274
	720×576	-	Lines 7, 320

- Audio Sample

An error is counted when audio that is asynchronous to the video is embedded. For the video and audio to be synchronized, there is a specific number of audio data samples that need to be embedded in a given number of video frames. If this rule is not met, it is considered an error.

- Check Sum

The instrument uses the checksum in the input signal's ancillary data header to count errors.

- Parity

The instrument uses the parity bit in the input signal's ancillary data header to count errors.

- Freeze

An error is counted when the video data is the same between video frames. Specify an area of the video to use for detection and the number of continuous frames that is required for the condition to be detected as an error.

Video data is compared using checksums.

- Black

An error is counted when the video luminance level is less than the specified value.

Set the luminance level for detecting error pixels, the ratio of error pixels in a frame, and the number of continuous frames that is required for the condition to be detected as an error.

- Gamut

Gamut errors are counted.

Set the upper and lower limits for detecting errors, the ratio of error pixels in a frame, and the number of continuous frames that is required for the condition to be detected as an error.

16. STATUS DISPLAY

- Comp Gamut

Composite gamut errors are counted.

Set the upper and lower limits for detecting errors, the ratio of error pixels in a frame, and the number of continuous frames that is required for the condition to be detected as an error.

- Level Y

An error is counted when the luminance level is outside the specified range.

Set the upper and lower limits for detecting errors.

- Level C

An error is counted when the chrominance level is outside the specified range.

Set the upper and lower limits for detecting errors.

- SinceReset

The time that has elapsed since F•7 ERROR CLEAR was pressed, the instrument was initialized, or the instrument was restarted is displayed.

16.2 Configuring Error Detection Settings

To configure the error detection settings, use **F•5** STATUS SETUP.

When error detection is set to ON, the following actions are performed when an error occurs.

- Counts errors on the status display. (except some of ERROR SETUP5 tab)
- Displays errors in the event log of the status display
- Displays "ERROR" in the upper right of the display. (except ERROR SETUP5 tab)
- Transmits a signal from the alarm output remote terminal (except ERROR SETUP5 tab)

16.2.1 Error Setup 1

Use the ERROR SETUP1 tab to configure error detection settings for SDI signals.



Figure 16-2 ERROR SETUP1 tab

• Error Counter

Sec: Errors are counted in units of seconds. Even if multiple errors occur within the same second, only a single error is counted.

Field: Errors are counted in units of fields (frames). Even if multiple errors occur within the same field (frame), only a single error is counted.

• TRS Error

Select whether to detect TRS Pos and TRS Code errors.

OFF / ON

• Line Number Error (Except SD)

Select whether to detect line number errors. This setting is valid when the input signal is not SD.

OFF / ON

16. STATUS DISPLAY

- CRC Error (Except SD)

Select whether to detect CRC errors. This setting is valid when the input signal is not SD.

OFF / ON

- EDH Error (SD)

Select whether to detect EDH errors. This setting is valid when the input signal is SD.

OFF / ON

- Illegal Code Error

Select whether to detect illegal code errors.

OFF / ON

- Frequency Error

Select whether to detect frequency deviation errors.

Even when this is set to OFF, the frequency deviation is still shown in the status display.

OFF / ON

- Cable Error

Select whether to detect cable errors.

Even when this is set to OFF, the cable length is still shown in the status display.

OFF / ON

- 12G Cable Error / Warning

Set the upper cable error limit and the upper cable warning limit for 12G input signals. If the value on the left side is exceeded, an error will occur, and the measured value on the status display will be displayed in red.

If the value on the right side is exceeded, a warning will occur, and the measured value on the status display will be displayed in yellow.

The cable used in cable length measurement is L-5.5CUHD.

10 – 80 m

- 3G Cable

Select the cable to use for cable length measurements when the input signal is 3G.

LS-5CFB / 1694A

- 3G Cable Error / Warning

Set the upper cable error limit and the upper cable warning limit for 3G input signals. If the value on the left side is exceeded, an error will occur, and the measured value on the status display will be displayed in red.

If the value on the right side is exceeded, a warning will occur, and the measured value on the status display will be displayed in yellow.

10 – 100 m

16. STATUS DISPLAY

- HD Cable

Select the cable to use for cable length measurements when the input signal is HD.

LS-5CFB / 1694A

- HD Cable Error / Warning

Set the upper cable error limit and the upper cable warning limit for HD input signals. If the value on the left side is exceeded, an error will occur, and the measured value on the status display will be displayed in red.

If the value on the right side is exceeded, a warning will occur, and the measured value on the status display will be displayed in yellow.

10 - 130 m

- SD Cable

Select the cable to use for cable length measurements when the input signal is SD.

L-5C2V / 8281

- SD Cable Error / Warning

Set the upper cable error limit and the upper cable warning limit for SD input signals. If the value on the left side is exceeded, an error will occur, and the measured value on the status display will be displayed in red.

If the value on the right side is exceeded, a warning will occur, and the measured value on the status display will be displayed in yellow.

50 - 200 m

16. STATUS DISPLAY

16.2.2 Error Setup 2

Use the ERROR SETUP2 tab to configure ancillary data and embedded audio error detection settings.

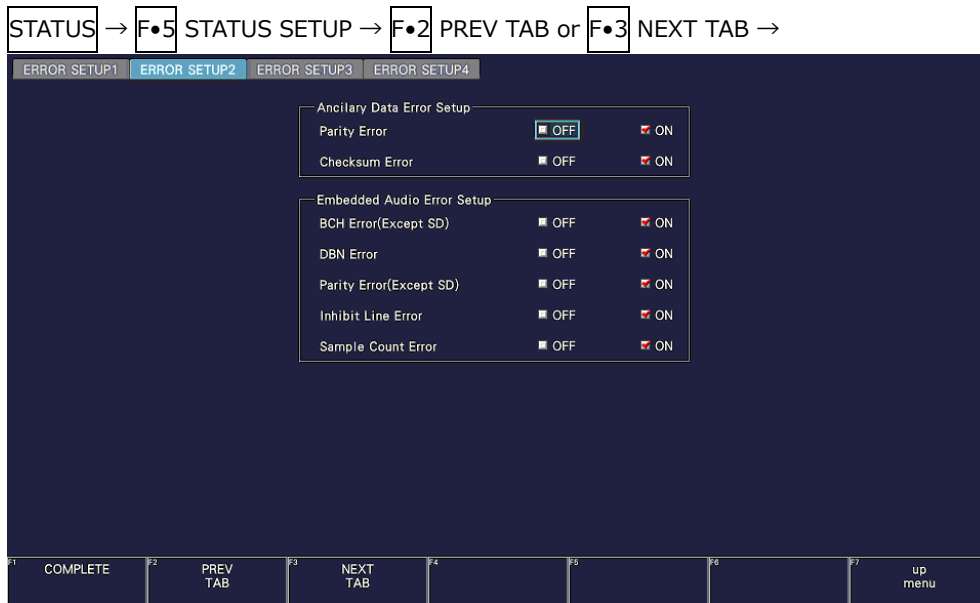

Figure 16-3 ERROR SETUP2 tab

- Parity Error

Select whether to detect parity errors in the ancillary data.

OFF / ON

- Checksum Error

Select whether to detect checksum errors in the ancillary data.

OFF / ON

- BCH Error (Except SD)

Select whether to detect BCH errors in the embedded audio. This setting is valid when the input signal is not SD.

OFF / ON

- DBN Error

Select whether to detect DBN errors in the embedded audio.

OFF / ON

- Parity Error (Except SD)

Select whether to detect parity errors in the embedded audio. This setting is valid when the input signal is not SD.

OFF / ON

16. STATUS DISPLAY

- Inhibit Line Error

Select whether to detect embedding errors in the embedded audio.

OFF / ON

- Sample Count Error

Select whether to detect sample number errors in the embedded audio.

An error is counted when audio that is asynchronous to the video is embedded. If a certain number of audio data samples are not embedded in a certain number of video frames, it will be considered an error (as defined in SMPTE ST 299 and SMPTE ST 272).

OFF / ON

16.2.3 Error Setup 3

In the ERROR SETUP3 tab, configure gamut error settings.

STATUS → F•5 STATUS SETUP → F•2 PREV TAB or F•3 NEXT TAB →



Figure 16-4 ERROR SETUP3 tab

- LowPass Filter

Select the frequency response of the low-pass filter used for gamut error and composite gamut error detection. Set this to remove transient errors caused by overshoot and other anomalies.

HD/SD:1MHz / HD:2.8MHz SD:1MHz / OFF

- Gamut Error

Select whether to detect gamut errors.

ON / OFF

16. STATUS DISPLAY

- Gamut Upper

Set the gamut error upper limit. An error occurs when the input signal level exceeds the specified value.

In the 5-bar GBR display, levels that are greater than or equal to the specified value are displayed in red.

90.8 - 109.4%

- Gamut Lower

Set the gamut error lower limit. An error occurs when the input signal level goes below the specified value.

In the 5-bar GBR display, levels that are less than or equal to the specified value are displayed in red.

-7.2 - 6.1%

- Area

Specify the percentage of the active picture area over which errors must occur to be recognized as an error. You cannot configure this setting when Gamut Error is set to OFF.

0.0 - 1.0 - 5.0%

- Duration

Set the number of consecutive video frames over which errors must occur to be recognized as an error. You cannot configure this setting when Gamut Error is set to OFF.

1 - 60 Frames

- Composite Gamut Error

Select whether to detect composite gamut errors.

ON / OFF

- Setup

Select the setup level to add when converting component signals to composite signals.

<u>0%</u> :	No setup level is added.
7.5%:	A setup level of 7.5 % is added.

16. STATUS DISPLAY

- Composite Upper

Set the composite gamut error upper limit. An error occurs when the input signal level exceeds the specified value.

In the 5-bar CMP display, levels that are greater than or equal to the specified value are displayed in red.

90.0 - 135.0%

- Composite Lower

Set the composite gamut error lower limit. An error occurs when the input signal level goes below the specified value.

In the 5-bar CMP display, levels that are less than or equal to the specified value are displayed in red.

-40.0 - 20.0%

- Area

Specify the percentage of the active picture area over which errors must occur to be recognized as an error. You cannot configure this setting when Composite Gamut Error is set to OFF.

0.0 - 1.0 - 5.0%

- Duration

Set the number of consecutive video frames over which errors must occur to be recognized as an error. You cannot configure this setting when Composite Gamut Error is set to OFF.

1 - 60 Frames

- Gamut Details

Turns on and off the extended display of gamut error.

ON / OFF

16. STATUS DISPLAY

16.2.4 Error Setup 4

On the ERROR SETUP4 tab, configure freeze error, black error, and level error settings.

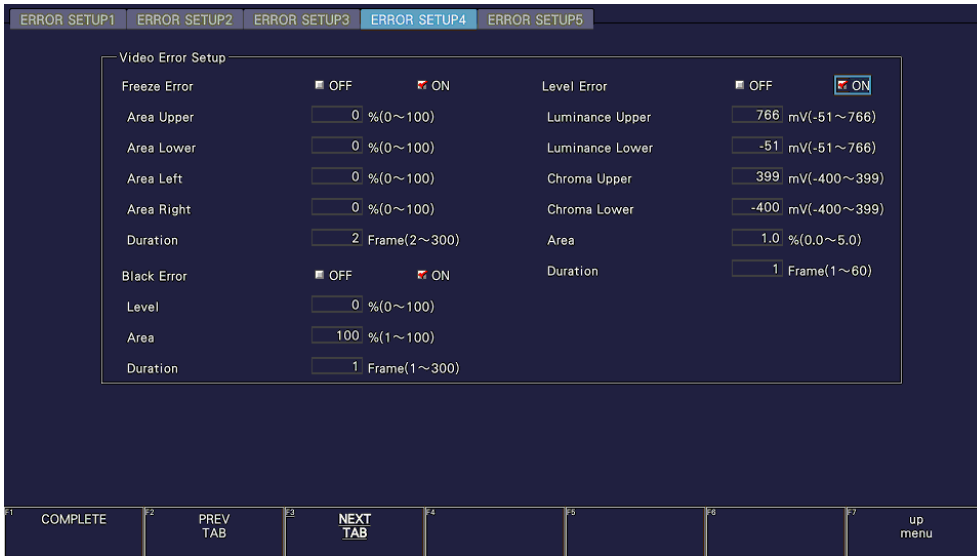

Figure 16-5 ERROR SETUP4 tab

- Freeze Error

Select whether to detect freeze errors. If you set this to OFF, you cannot configure the following settings.

ON / OFF

- Area Upper / Area Lower / Area Left / Area Right

Set what percent of each active picture area (the upper, lower, left, and right areas) will not be subject to error detection.

0 - 100%

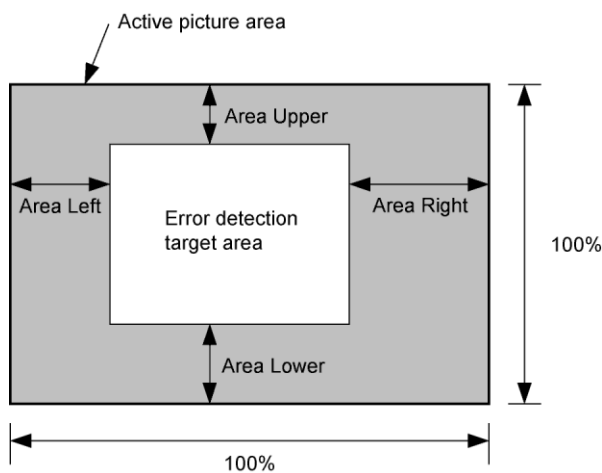

16. STATUS DISPLAY

- Duration

Set the number of consecutive video frames over which errors must occur to be recognized as an error.

2 - 300 Frames

- Black Error

Select whether to detect black errors. If you set this to OFF, you cannot configure the following settings.

ON / OFF

- Level

Set the black error level. Any signals that are less than or equal to the specified value will be detected as errors.

0 - 100%

- Area

Specify the percentage of the active picture area over which errors must occur to be recognized as an error.

1 - 100%

- Duration

Set the number of consecutive video frames over which errors must occur to be recognized as an error.

1 - 300 Frames

- Level Error

Select whether to detect level errors. If you set this to OFF, you cannot configure the following settings.

ON / OFF

- Luminance Upper

Set the luminance level error upper limit. An error occurs when the input signal level exceeds the specified value.

In the 5-bar Y display, levels that are greater than or equal to the specified value are displayed in red.

-51 - 766mV

16. STATUS DISPLAY

- Luminance Lower

Set the luminance level error lower limit. An error occurs when the input signal level goes below the specified value.

In the 5-bar Y display, levels that are less than or equal to the specified value are displayed in red.

-51 - 766mV

- Chroma Upper

Set the chroma level error upper limit. An error occurs when the input signal level exceeds the specified value.

-400 - 399mV

- Chroma Lower

Set the chroma level error lower limit. An error occurs when the input signal level goes below the specified value.

-400 - 399mV

- Area

Specify the percentage of the active picture area over which errors must occur to be recognized as an error.

0.0 - 1.0 - 5.0%

- Duration

Set the number of consecutive video frames over which errors must occur to be recognized as an error.

1 - 60 Frames

16. STATUS DISPLAY

16.2.5 Error Setup 5 (SER05/SER06)

Use the ERROR SETUP5 tab to configure error detection settings for IP signals.

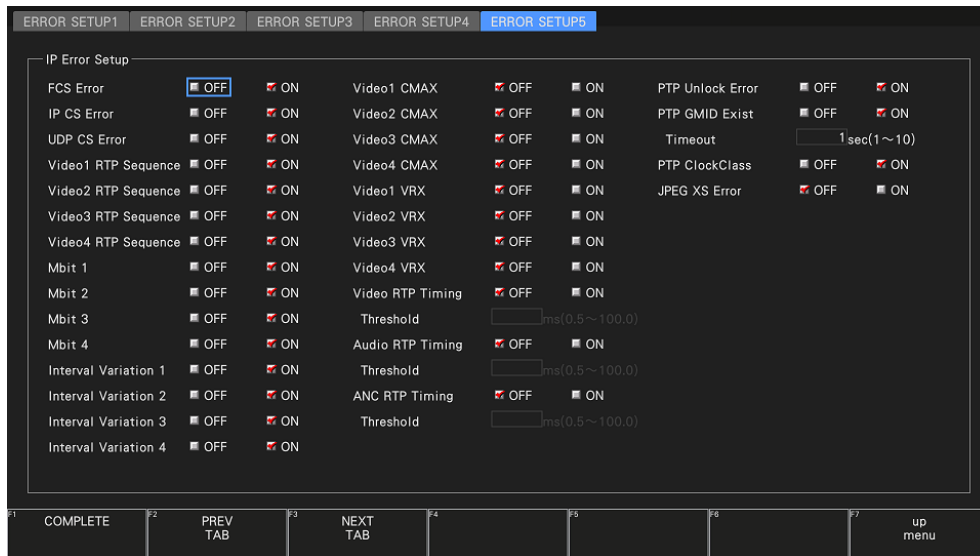

Figure 16-6 ERROR SETUP5 tab

- FCS Error

Select whether to detect FCS errors.

OFF / ON

- IP CS Error

Select whether to detect IP checksum errors.

OFF / ON

- UDP CS Error

Select whether to detect UDP checksum errors.

OFF / ON

- Video1 RTP Sequence

Select whether to detect packet loss or reordering of IP stream 1.

OFF / ON

- Video2 RTP Sequence

Select whether to detect packet loss or reordering of IP stream 2.

OFF / ON

16. STATUS DISPLAY

- Video3 RTP Sequence

Select whether to detect packet loss or reordering of IP stream 3.

OFF / ON

- Video4 RTP Sequence

Select whether to detect packet loss or reordering of IP stream 4.

OFF / ON

- Mbit 1

Select whether to detect IP stream 1 marker bit errors.

OFF / ON

- Mbit 2

Select whether to detect IP stream 2 marker bit errors.

OFF / ON

- Mbit 3

Select whether to detect IP stream 3 marker bit errors.

OFF / ON

- Mbit 4

Select whether to detect IP stream 4 marker bit errors.

OFF / ON

- Interval Variation 1

Select whether to detect when the packet arrival interval of Video stream 1 becomes large.

OFF / ON

- Interval Variation 2

Select whether to detect when the packet arrival interval of Video stream 2 becomes large.

OFF / ON

- Interval Variation 3

Select whether to detect when the packet arrival interval of Video stream 3 becomes large.

OFF / ON

16. STATUS DISPLAY

- Interval Variation 4

Select whether to detect when the packet arrival interval of Video stream 4 becomes large.

OFF / ON

- Video1 CMAX

Select whether to detect when Video Stream 1 exceeds the CMAX value.

OFF / ON

- Video2 CMAX

Select whether to detect when Video Stream 2 exceeds the CMAX value.

OFF / ON

- Video3 CMAX

Select whether to detect when Video Stream 3 exceeds the CMAX value.

OFF / ON

- Video4 CMAX

Select whether to detect when Video Stream 4 exceeds the CMAX value.

OFF / ON

- Video1 VRX

Select whether to detect when Video Stream 1 exceeds the VRX full value.

OFF / ON

- Video2 VRX

Select whether to detect when Video Stream 2 exceeds the VRX full value.

OFF / ON

- Video3 VRX

Select whether to detect when Video Stream 3 exceeds the VRX full value.

OFF / ON

- Video4 VRX

Select whether to detect when Video Stream 4 exceeds the VRX full value.

OFF / ON

16. STATUS DISPLAY

- Video RTP Timing

Select whether to detect when the RTP timestamp of the video stream is greater than the threshold for the PTP reference clock.

OFF / ON

- Threshold

Sets the upper limit for the RTP timestamp of the video stream. An error will occur if the value exceeds the set value. It cannot be set when the Video RTP Timing is set to OFF.

0.5 – 20.0 – 100.0 ms

- Audio RTP Timing

Select whether to detect when the RTP timestamp of the audio stream is greater than the threshold for the PTP reference clock.

OFF / ON

- Threshold

Sets the upper limit for the RTP timestamp of the audio stream. An error will occur if the value exceeds the set value. It cannot be set when the Audio RTP Timing is set to OFF.

0.5 – 20.0 – 100.0 ms

- ANC RTP Timing

Select whether to detect when the RTP timestamp of the ANC stream is greater than the threshold for the PTP reference clock.

OFF / ON

- Threshold

Sets the upper limit for the RTP timestamp of the ANC stream. An error will occur if the value exceeds the set value. It cannot be set when the ANC RTP Timing is set to OFF.

0.5 – 20.0 – 100.0 ms

- PTP Unlock Error

Select whether to detect PTP unlock errors.

OFF / ON

- PTP GMID Exist

Select whether to detect GMID (grandmasterIdentity).

When turned ON, the GMID obtained from the PTP announce message is displayed in the event log. A PTP GMID error will be displayed if the GMID cannot be obtained within the period set in Timeout.

OFF / ON

16. STATUS DISPLAY

- Timeout

Set the period to consider PTP GMID error. An error will occur if the GMID cannot be acquired within the period set here. It cannot be set when the PTP GMID Exist is set to OFF.

1 - 10 sec

- PTP ClockClass

Select whether to detect when PTP ClockClass changes.

OFF / ON

- JPEG XS Error

Select whether to detect errors that occur in the JPEG XS decoder.

Error detection factors include packet sequence errors, frame sequence errors, and last packet sequence errors.

OFF / ON

16. STATUS DISPLAY

16.3 Clearing Error Counts

To clear the error counts and SinceReset, follow the procedure below.

Procedure

STATUS	→	F•7	ERROR CLEAR
--------	---	-----	-------------

16.4 Configuring Event Log Settings

To display the event log, follow the procedure below.

The event log displays a list of the events that have occurred.

The applicable event-detection channels are all channels in A to D. However, when measuring 3G-B DS, 3G(DL)-4K, 6G, or 12G, events are detected only on the currently displayed channel.

Procedure

STATUS	→	F•1	EVENT LOG
--------	---	-----	-----------

SDI (SER01/SER02/SER02A/SER23/SER28/SER29/SER31)

EVENT LOG LIST		SAMPLE No.41		<< NOW LOGGING >>	
18: 2019/07/23 10:53:36	A	1920x1080/59.94P	CRC,Freeze,		
17: 2019/07/23 10:52:35	A	1920x1080/59.94P	Freeze,		
16: 2019/07/23 10:52:33	-	EMB-AUDIO			
15: 2019/07/23 10:52:32	A	1920x1080/59.94P	Freeze,Frequency,		
14: 2019/07/23 10:52:32	-	EMB-AUDIO	CRC,		
13: 2019/07/23 10:52:32	A	1920x1080/60P	Freeze,Format Alarm,		
12: 2019/07/23 10:52:32	A	NO SIGNAL			
11: 2019/07/23 10:52:23	A	1920x1080/60P	Freeze,Format Alarm,		
10: 2019/07/23 10:52:19	-	EMB-AUDIO			
9: 2019/07/23 10:52:19	-	EMB-AUDIO	CRC,		

CRC	EDH	TRS Position	TRS Code	Illegal Code	Line Number
Cable Error	Cable Warning	Check Sum	Parity	Gamut	
Cmp. Gamut		Freeze		Black	
Level Y		Level C			
Audio BCH	Audio Parity	Audio DBN	Audio Inhibit	Audio Sample	
Frequency	Format Alarm				
TC NO	TC RPT	TC SKIP			

AUDIO (SER03)

EVENT LOG LIST		SAMPLE No.41		<< NOW LOGGING >>	
16: 2019/07/23 10:52:33	-	EMB-AUDIO			
15: 2019/07/23 10:52:32	A	1920x1080/59.94P	Freeze,Frequency,		
14: 2019/07/23 10:52:32	-	EMB-AUDIO	CRC,		
13: 2019/07/23 10:52:32	A	1920x1080/60P	Freeze,Format Alarm,		
12: 2019/07/23 10:52:32	A	NO SIGNAL			
11: 2019/07/23 10:52:23	A	1920x1080/60P	Freeze,Format Alarm,		
10: 2019/07/23 10:52:19	-	EMB-AUDIO			
9: 2019/07/23 10:52:19	-	EMB-AUDIO	CRC,		
8: 2019/07/23 10:52:18	A	1920x1080/60P	Freeze,Frequency,Format Alarm,		
7: 2019/07/23 10:52:18	A	1920x1080/59.94P	Freeze,		

Validity	1	2	3	4	5	6	7	8
CRC	1	2	3	4	5	6	7	8
Clip	1	2	3	4	5	6	7	8
Mute	1	2	3	4	5	6	7	8
Level Ov.	1	2	3	4	5	6	7	8
Parity	1	2	3	4	5	6	7	8
Code Vil.	1	2	3	4	5	6	7	8

16. STATUS DISPLAY

IP (SER05/SER06)

EVENT LOG LIST		SAMPLE No.33	IP A	TIME: 10:58:26
30: 2023/08/31 10:57:51	IP2 LINK UP			PTP Unlock,PTP GMID,JPEG XS Error?
29: 2023/08/31 10:57:51	IP1 LINK UP			Video1 RTP Sequence,PTP Unlock,PTP G...
28: 2023/08/31 10:57:51	A NO SIGNAL			
27: 2023/08/31 10:57:49	A 1920x1080/59.94I			
26: 2023/08/31 10:57:47	A NO SIGNAL			
25: 2023/08/31 10:57:47	A 1920x1080/59.94I			
24: 2023/08/31 10:57:46	A NO SIGNAL			
23: 2023/08/31 10:57:10	A 1920x1080/59.94I			
22: 2023/08/31 10:57:09	IP1 LINK UP			PTP Unlock,PTP GMID,
21: 2023/08/31 10:57:08	IP2 LINK UP			PTP Unlock,PTP GMID,

FCS	IP CS	UDP CS	
Video1 RTP Sequence	Video2 RTP Sequence	Video3 RTP Sequence	Video4 RTP Sequence
Mbit Stream1	Mbit Stream2	Mbit Stream3	Mbit Stream4
Interval Variation1	Interval Variation2	Interval Variation3	Interval Variation4
PTP Unlock	PTP GMID	PTP ClockClass	JPEG XS Error
Video1 RTP Timing	Video2 RTP Timing	Video3 RTP Timing	Video4 RTP Timing
Audio1 RTP Timing	Audio2 RTP Timing	Audio3 RTP Timing	Audio4 RTP Timing
ANC1 RTP Timing	ANC2 RTP Timing	ANC3 RTP Timing	ANC4 RTP Timing
Video1 CMAX	Video2 CMAX	Video3 CMAX	Video4 CMAX
Video1 VRX	Video2 VRX	Video3 VRX	Video4 VRX

Figure 16-7 Event log display

16.4.1 Event Log Screen Description

Events are listed on the event log screen by the time of their occurrence.

Turn the function dial (F•D) to the right to scroll the screen and view older events in the log.

Press the function dial (F•D) to display the latest events.

- Notes

- When the same event occurs successively and when multiple events occur at the same time, they are treated as a single event.
- When multiple events occur at the same time, you may not be able to check all the events on the screen. When this happens, you can view all the events by saving them to a USB memory device.
- The event display is cleared when you turn the power off.
- Switching video formats or input channels may cause disturbances in the signal that will cause errors to be displayed.

- Time Display

The time is displayed in the format specified by Time that you select by pressing **SYS** → **F•2** SYSTEM SETUP.

- Channel display

The input channel is displayed.

A “-” is displayed for audio events detected by SER03.

“IP1” or “IP2” is displayed for IP events detected by SER05 or SER06.

16. STATUS DISPLAY

- Format Display

The input format is displayed.

If there is no input signal, "NO SIGNAL" is displayed.

"EMB-AUDIO" or "EXT-AUDIO" is displayed for audio events detected by SER03.

"LINK UP" or "LINK DOWN" is displayed for IP events detected by SER05 or SER06.

- Event Display

Events are displayed in the list in the top half and in the frame in the lower half.

Events are displayed one line at a time in rectangular frames. In the frame, the event occurrence state is shown for the number that you selected with the function dial (F•D).

Further, for audio events detected by SER03, the corresponding channels are shown.

The colors are used in frames to indicate different states. Gray indicates not applicable for counting. White indicates no event. Red indicates that an event is occurring. Green indicates that an event occurred in the past (not occurring currently).

The events that are displayed in the event log are listed below.

Of the items listed below, only those whose detection settings have been set to ON on the SDI IN SETUP2 tab and CAPTURE&DISPLAY tab of the SYS menu, GAMUT COLOR LOG and MAX FALL/CLL ERROR of the PIC menu, STATUS SETUP of the STATUS menu, ERROR SETUP of the EYE menu, and ERROR SETUP of the AUDIO menu are displayed.

Table 16-2 Events

Applicable Options	Event Name (in frame)	Event Name (list)	Description
SER01/SER02/ SER23/SER02A/ SER28/SER29/ SER31	CRC	CRC	CRC Error(Except SD)
	EDH	EDH	EDH Error(SD)
	TRS Position	TRS Position	TRS Position Error
	TRS_Code	TRS_Code	TRS Code Error
	Illegal Code	Illegal Code	Illegal Code Error
	Line Number	Line Number	Line Number Error(Except SD)
	Cable Error	Cable Error	Cable Error
	Cable Warning	Cable Warning	Cable Warning
	Check Sum	Check Sum	Ancillary Data Checksum Error
	Parity	Parity	Ancillary Data Parity Error
	Gamut	Gamut	Gamut Error(Gamut Details = OFF)
	Gmt R	Gamut R	Gamut Error R UPPER(Gamut Details = ON)
	Gmt G	Gamut G	Gamut Error G UPPER(Gamut Details = ON)
	Gmt B	Gamut B	Gamut Error B UPPER(Gamut Details = ON)
	Gmt r	Gamut r	Gamut Error R LOWER(Gamut Details = ON)
	Gmt g	Gamut g	Gamut Error G LOWER(Gamut Details = ON)
	Gmt b	Gamut b	Gamut Error B LOWER(Gamut Details = ON)
	Gamut ST1	Gamut ST1	Gamut Error Stream 1(Gamut Details = OFF)
	Gmt R ST1	Gamut R ST1	Gamut Error Stream 1 R UPPER(Gamut Details = ON)
	Gmt G ST1	Gamut G ST1	Gamut Error Stream 1 G UPPER(Gamut Details = ON)
	Gmt B ST1	Gamut B ST1	Gamut Error Stream 1 B UPPER(Gamut Details = ON)
Gmt r ST1	Gamut r ST1	Gamut Error Stream 1 R LOWER(Gamut Details = ON)	
Gmt g ST1	Gamut g ST1	Gamut Error Stream 1 G LOWER (Gamut Details = ON)	
Gmt b ST1	Gamut b ST1	Gamut Error Stream 1 B LOWER (Gamut Details = ON)	

16. STATUS DISPLAY

Applicable Options	Event Name (in frame)	Event Name (list)	Description
			= ON)
	Gamut ST2	Gamut ST2	Gamut Error Stream 2(Gamut Details = OFF)
	Gmt R ST2	Gamut R ST2	Gamut Error Stream 2 R UPPER(Gamut Details = OFF)
	Gmt G ST2	Gamut G ST2	Gamut Error Stream 2 G UPPER(Gamut Details = OFF)
	Gmt B ST2	Gamut B ST2	Gamut Error Stream 2 B UPPER(Gamut Details = OFF)
	Gmt r ST2	Gamut r ST2	Gamut Error Stream 2 r LOWER(Gamut Details = OFF)
	Gmt g ST2	Gamut g ST2	Gamut Error Stream 2 g LOWER(Gamut Details = OFF)
	Gmt b ST2	Gamut b ST2	Gamut Error Stream 2 b LOWER(Gamut Details = OFF)
	Cmp. Gamut	Cmp. Gamut	Composite Gamut Error
	Cmp. Gamut ST1	Cmp. Gamut ST1	Composite Gamut Error Stream 1
	Cmp. Gamut ST2	Cmp. Gamut ST2	Composite Gamut Error Stream 2
	Freeze	Freeze	Freeze Error
	Freeze ST1	Freeze ST1	Freeze Error Stream 1
	Freeze ST2	Freeze ST2	Freeze Error Stream 2
	Black	Black	Black Error
	Black ST1	Black ST1	Black Error Stream 1
	Black ST2	Black ST2	Black Error Stream 2
	Level Y	Level Y	Luminance Error(Gamut Details = OFF)
	Level Y	Level Y	Luminance Error Y UPPER(Gamut Details = ON)
	Level y	Level y	Luminance Error Y LOWER(Gamut Details = ON)
	Level Y ST1	Level Y ST1	Luminance Error Stream 1(Gamut Details = OFF)
	Level Y ST1	Level Y ST1	Luminance Error Stream 1 Y UPPER(Gamut Details = ON)
	Level y ST1	Level y ST1	Luminance Error Stream 1 Y LOWER(Gamut Details = ON)
	Level Y ST2	Level Y ST2	Luminance Error Stream 2(Gamut Details = OFF)
	Level Y ST2	Level Y ST2	Luminance Error Stream 2 Y UPPER(Gamut Details = ON)
	Level y ST2	Level y ST2	Luminance Error Stream 2 Y LOWER(Gamut Details = ON)
	Level C	Level C	Chroma Error
	Level C ST1	Level C ST1	Chroma Error Stream 1
	Level C ST2	Level C ST2	Chroma Error Stream 2
	Color Gamut	COLOR GAMUT	Colorimetry Zone
	Color Gamut ST1	COLOR GAMUT ST1	Colorimetry Zone Stream 1
	Color Gamut ST2	COLOR GAMUT ST2	Colorimetry Zone Stream 2
	Audio BCH	Audio BCH	Embedded Audio BCH Error(Except SD)
	Audio Parity	Audio Parity	Embedded Audio Parity Error(Except SD)
	Audio DBN	Audio DBN	Embedded Audio DBN Error
	Audio Inhibit	Audio Inhibit	Embedded Audio Inhibit Line Error
	Audio Sample	Audio Sample	Embedded Audio Sample Count Error
	Frequency	Frequency	Frequency Error
	Format Alarm	Format Alarm	Format Alarm
	Max Fall	MAX FALL	MAX FALL Error
	Max Fall ST1	MAX FALL ST1	MAX FALL Error Stream 1
	Max Fall ST2	MAX FALL ST2	MAX FALL Error Stream 2
	Max Cll	MAX CLL	MAX CLL Error

16. STATUS DISPLAY

Applicable Options	Event Name (in frame)	Event Name (list)	Description
	Max Cll ST1	MAX CLL ST1	MAX CLL Error Stream 1
	Max Cll ST2	MAX CLL ST2	MAX CLL Error Stream 2
	TC NO	TC:NO	No Timecode
	TC RPT	TC:RPT	Timecode Repeat
	TC SKIP	TC:SKIP	Timecode Skip
SER02/SER02A (other than 12G) SER02/SER02A + SER28/SER29 (12G)	EYE Jitter	EYE 12G Jitter	12G Jitter Error
		EYE 3G Jitter	3G Jitter Error
		EYE 6G Jitter	6G Jitter Error
		EYE HD Jitter	HD Jitter Error
		EYE SD Jitter	SD Jitter Error
	EYE T Jitter	EYE 12G T Jitter	12G Timing Jitter Error
		EYE 6G T Jitter	6G Timing Jitter Error
		EYE 3G T Jitter	3G Timing Jitter Error
		EYE HD T Jitter	HD Timing Jitter Error
		EYE SD T Jitter	SD Timing Jitter Error
	EYE Tr_Tf	EYE 12G Tr_Tf	12G Deltatime Error(Tr-Tf)
		EYE 6G Tr_Tf	6G Deltatime Error(Tr-Tf)
		EYE 3G Tr_Tf	3G Deltatime Error(Tr-Tf)
		EYE HD Tr_Tf	HD Deltatime Error(Tr-Tf)
		EYE SD Tr_Tf	SD Deltatime Error(Tr-Tf)
	EYE Tf	EYE 12G Tf	12G Falltime Error
		EYE 6G Tf	6G Falltime Error
		EYE 3G Tf	3G Falltime Error
		EYE HD Tf	HD Falltime Error
		EYE SD Tf	SD Falltime Error
	EYE Tr	EYE 12G Tr	12G Risetime Error
		EYE 6G Tr	6G Risetime Error
		EYE 3G Tr	3G Risetime Error
		EYE HD Tr	HD Risetime Error
		EYE SD Tr	SD Risetime Error
	EYE Amp.	EYE 12G Amp.	12G Amplitude Error
		EYE 6G Amp.	6G Amplitude Error
		EYE 3G Amp.	3G Amplitude Error
		EYE HD Amp.	HD Amplitude Error
		EYE SD Amp.	SD Amplitude Error
	EYE Or	EYE 12G Or	12G OverShoot Rising Error
		EYE 6G Or	6G OverShoot Rising Error
		EYE 3G Or	3G OverShoot Rising Error
		EYE HD Or	HD OverShoot Rising Error
		EYE SD Or	SD OverShoot Rising Error
	EYE Of	EYE 12G Of	12G OverShoot Falling Error
		EYE 6G Of	6G OverShoot Falling Error
		EYE 3G Of	3G OverShoot Falling Error
		EYE HD Of	HD OverShoot Falling Error
		EYE SD Of	SD OverShoot Falling Error
SER03	Validity	Validity	Validity Error
	CRC	CRC	CRC Error
	Clip	Clip	Clip
	Mute	Mute	Mute
	Level Ov.	Level Ov.	Level Over
	Parity	Parity	Parity Error
	Code Vil.	Code Vil.	Code Violation
SER05/SER06	FCS	FCS	FCS Error
	IP CS	IP CS	IP CS Error
	UDP CS	UDP CS	UDP CS Error

16. STATUS DISPLAY

Applicable Options	Event Name (in frame)	Event Name (list)	Description
	Video1 RTP Sequence	Video1 RTP Sequence	Video1 RTP Sequence Error
	Video2 RTP Sequence	Video2 RTP Sequence	Video2 RTP Sequence Error
	Video3 RTP Sequence	Video3 RTP Sequence	Video3 RTP Sequence Error
	Video4 RTP Sequence	Video4 RTP Sequence	Video4 RTP Sequence Error
	Mbit Stream1	Mbit Stream1	Mbit 1
	Mbit Stream2	Mbit Stream2	Mbit 2
	Mbit Stream3	Mbit Stream3	Mbit 3
	Mbit Stream4	Mbit Stream4	Mbit 4
	Interval Variation1	Interval Variation1	Interval Variation1 Error
	Interval Variation2	Interval Variation2	Interval Variation2 Error
	Interval Variation3	Interval Variation3	Interval Variation3 Error
	Interval Variation4	Interval Variation4	Interval Variation4 Error
	PTP Unlock	PTP Unlock	PTP Unlock Error
	PTP GMID	PTP GMID	PTP GMID Exist
	PTP ClockClass	PTP ClockClass	PTP ClockClass
	JPEG XS Error	JPEG XS Error:XX	JPEG XS Error (XX is error code 2 to 99) 2 = Unsupported format error 5 = Image size error 7 = CAP marker error 8 = PIH marker error 9 = CDT marker error 10 = WGT marker error 11 = SLH marker error 12 = Precinct length error 13 = Codestream length error 14 = Codestream last error 99 = Unknown error
	Video1 RTP Timing	Video1 RTP Timing	Video stream 1 RTP Timing Error
	Video2 RTP Timing	Video2 RTP Timing	Video stream 2 RTP Timing Error
	Video3 RTP Timing	Video3 RTP Timing	Video stream 3 RTP Timing Error
	Video4 RTP Timing	Video4 RTP Timing	Video stream 4 RTP Timing Error
	Audio1 RTP Timing	Audio1 RTP Timing	Audio stream 1 RTP Timing Error
	Audio2 RTP Timing	Audio2 RTP Timing	Audio stream 2 RTP Timing Error
	Audio3 RTP Timing	Audio3 RTP Timing	Audio stream 3 RTP Timing Error
	Audio4 RTP Timing	Audio4 RTP Timing	Audio stream 4 RTP Timing Error
	ANC1 RTP Timing	ANC1 RTP Timing	ANC stream 1 RTP Timing Error
	ANC2 RTP Timing	ANC2 RTP Timing	ANC stream 2 RTP Timing Error
	ANC3 RTP Timing	ANC3 RTP Timing	ANC stream 3 RTP Timing Error
	ANC4 RTP Timing	ANC4 RTP Timing	ANC stream 4 RTP Timing Error
	Video1 CMAX	Video1 CMAX	Video stream 1 CMAX Error
	Video2 CMAX	Video2 CMAX	Video stream 2 CMAX Error
	Video3 CMAX	Video3 CMAX	Video stream 3 CMAX Error
	Video4 CMAX	Video4 CMAX	Video stream 4 CMAX Error
	Video1 VRX	Video1 VRX	Video stream 1 VRX Full Error
	Video2 VRX	Video2 VRX	Video stream 2 VRX Full Error
	Video3 VRX	Video3 VRX	Video stream 3 VRX Full Error
	Video4 VRX	Video4 VRX	Video stream 4 VRX Full Error

16. STATUS DISPLAY

16.4.2 Starting the Event Log

To start the event log, follow the procedure below.

Procedure

STATUS	→	F•1	EVENT LOG	→	F•1	LOG: START / <u>STOP</u>
--------	---	-----	-----------	---	-----	--------------------------

Settings

START: The event log is started. "NOW LOGGING" appears in the upper right of the event log.

STOP: The event log is stopped. "LOGGING STOPPED" appears in the upper right of the event log.

16.4.3 Clearing the Event Log

To delete the event log, follow the procedure below.

Procedure

STATUS	→	F•1	EVENT LOG	→	F•2	CLEAR
--------	---	-----	-----------	---	-----	-------

16.4.4 Selecting the Overwrite Mode

Up to 1000 events can be displayed. To select the action to perform when more than 1000 events occur, follow the procedure below.

Procedure

STATUS	→	F•1	EVENT LOG	→	F•3	LOG MODE: <u>OVER WRT</u> / STOP
--------	---	-----	-----------	---	-----	----------------------------------

Settings

OVER WRT: Oldest events are overwritten.

STOP: Additional events are not recorded.

16. STATUS DISPLAY

16.4.5 Saving to a USB Memory Device

You can save the event log to a USB memory device as a text file.
To save a file with a name that you specify, follow the procedure below.

1. Used to connect USB memory.
2. Press **F•6** USB MEMORY.

The file list screen appears.

This setting appears when a USB memory device is connected.

No.	Filename	Date&Time	Size(byte)
1	20180712164804.txt	2018/07/12 16:48:04	259
2	20180712164808.txt	2018/07/12 16:48:08	259

Disk Size: 4,003,266,560 Byte
Free Size: 3,910,402,048 Byte

LOG Store File Name
.txt

F1 AUTO FILENAME ON F2 STORE F3 FILE DELETE F4 up menu F5 F6 F7

Figure 16-8 File list screen

3. Set **F•1** AUTO FILENAME to OFF.
4. Press **F•2** NAME INPUT.

The file name input display appears.

[F.D_NOB] = CHAR SELECT, [F.D_PUSH] = CHAR SET & Function Key Edit

LOG Store File Name
.txt

F1 CLEAR ALL F2 DELETE F3 F4 <= F5 => F6 CHAR SET F7 up menu

Figure 16-9 File name input screen

16. STATUS DISPLAY

5. Enter a file name using up to 14 characters.

The key operations that you can perform in the file name input display are as follows:

F•1	CLEAR ALL	Deletes all characters
F•2	DELETE	Deletes the character at the cursor
F•4	<=	Moves the cursor to the left
F•5	=>	Moves the cursor to the right
F•6	CHAR SET	Enters the character
Function dial (F•D)		Turn to select a character, and press to enter the character.

You can also copy the file name of an already saved file. To copy a file name, move the cursor to the file in the file list whose name you want to copy, and then press the function dial (F•D).

6. Press **F•7** up menu.
7. Press **F•3** STORE.

If a file with the same name that you have specified already exists on the USB memory device, an overwrite confirmation menu appears. To overwrite the existing preset, **F•1** OVER WR YES. Otherwise, press **F•3** OVER WR NO.

- Deleting an Event Log

To delete an event log that has been saved to the USB memory device, select the log file on the file list display, and then press **F•4** FILE DELETE. To delete the file, press **F•1** DELETE YES. To cancel the delete operation, press **F•3** DELETE NO.

- Automatic File Name Generation

If you set **F•1** AUTO FILENAME to ON, the file name will be generated automatically in the format "YYYYMMDDhhmmss" when you save the file. In this situation, **F•2** NAME INPUT is not displayed.

- USB Memory Device Folder Structure

Event logs are saved in the LOG folder.

- 📁 USB memory device
 - ↳ 📁 LV5600_USER or LV7600_USER
 - ↳ 📁 LOG
 - ↳ 📄 YYYYMMDDhhmmss.txt

16.5 Configuring the Data Dump Settings

To view the data dump, follow the procedure below.

In the data dump, the data of the selected line is listed. You can change the line number using the V POS knob and the sample number using the H POS knob. (You can also use the function dial (F•D).

Changing this setting will also change the selected line on the video-signal-waveform, vector, and picture displays (excluding some of the 4K settings).

When an SER05 or SER06 is installed, the SDI ANALYSIS becomes the SDI/IP ANALYSIS menu.

Procedure

STATUS	→	F•2	SDI ANALYSIS or SDI / IP ANALYSIS	→	F•1	DATA DUMP
--------	---	-----	-----------------------------------	---	-----	-----------

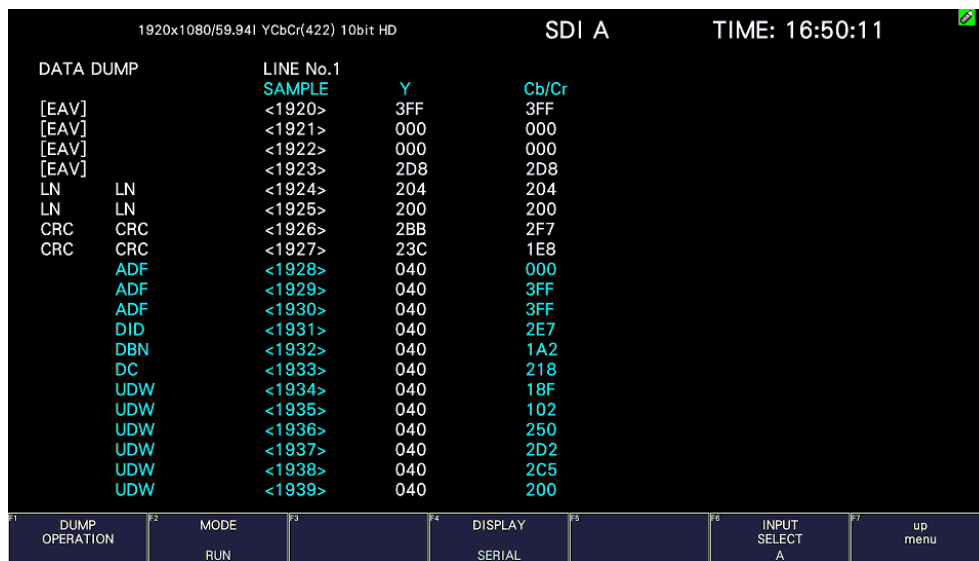

Figure 16-10 Data dump display

16. STATUS DISPLAY

16.5.1 Data Dump Display Description

- Detection Code Display

The input signal's embedded ancillary data is detected, and the following detection codes are displayed.

Table 16-3 Detection code display

Detection Code	Display Colors	Description
ADF	Cyan	Ancillary data flags (000h, 3FFh, and 3FFh)
DID	Cyan	Data identification (the data after ADF)
SDID	Cyan	SECONDARY DATA IDENTIFICATION (the secondary format data when the DID is smaller than 80h)
DBN	Cyan	DATA BLOCK NUMBERS (the primary data format when the DID is larger than 80h)
DC	Cyan	Data count (the data after the SDID/DBN)
UDW	Cyan	User data words (the user data words of the data count length after ADF)
CS	Magenta	Checksum (the data immediately after UDW)
AP	Yellow	ACTIVE PICTURE (From after the SAV to just before the EAV when the selected line is within the active video area)

- Line Number Display

Pictures sent in SDI signals are assigned line numbers as part of the transmission format. The line number is displayed in one of the following formats at the top of the screen.

Figure 16-4 Line number display

Line number display	Description
LINE No.	The picture scan line numbers and the line numbers during transmission are matched.
I/F LINE No.	The picture scan line numbers and the line numbers during transmission are not matched. Line numbers during transmission are displayed.
PIC LINE No.	The picture scan line numbers and the line numbers during transmission are not matched. Picture scan line numbers are displayed.

Normally, the picture scan line numbers and the line numbers for storing those line numbers during transmission are matched. However, they do not match when the following format is received.

If this is the case, you can switch between the picture scan line number (PICTURE) and line numbers during transmission.

Table 16-5 Format

Format	Frame Rate	Switching operation
3G-B-DL	60/59.94/50/48/47.95/P	F•4 DISPLAY (PICTURE/STREAM1/STREAM2)
HD(DL)	60/59.94/50/48/47.95/P	F•5 LINK (PICTURE/A/B)
3G(DL)-2K	60/59.94/50/48/47.95/P	F•5 LINK (PICTURE/1/2)

16. STATUS DISPLAY

As an example, the switching procedure for setting the picture scan line number to 42 when 3G-B-DL (1920×1080/59.94P) is applied is shown below.

1. Data dump is displayed.
2. Set **F•4** DISPLAY to PICTURE.
3. Use the V POS knob to set PIC LINE No. to 42.
4. Set **F•4** DISPLAY to STREAM1.

The line number display changes to I/F LINE No.21.

This indicates that the line number in which the picture scan line number 42 is stored for transmission is 21.

The relationship of other 3G-B-DL line numbers is shown below.

Table 16-6 3G-B-DL line number relationship

Picture scan line number (PIC LINE No.)	Line number during transmission (I/F LINE No.)	
	STREAM1	STREAM2
PICTURE		
1	563	1125
2	1	563
n (odd number)	$(n+1)/2+562$	$(n-1)/2$
m (even number)	$m/2$	$m/2+562$

16.5.2 Moving the Display Position

To configure data dump operation settings, press **F•1** DUMP OPERATION on the DATA DUMP menu.

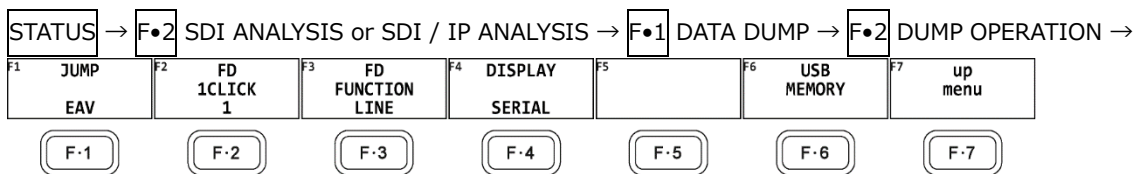

Figure 16-11 DUMP OPERATION menu

To move the data dump sample number to a specific location, follow the procedure below.

Procedure

STATUS → **F•2** SDI ANALYSIS or SDI / IP ANALYSIS → **F•1** DATA DUMP → **F•2** DUMP OPERATION → **F•1** JUMP

: EAV / SAV

: END / START (when the input signal is 4K and **F•5** LINK or **F•5** SUB is set to PICTURE)

Settings

EAV: The display starts with the EAV sample number.
 SAV: The display starts with the SAV sample number.
 END: The last sample number is displayed.
 START: The display starts with sample number 0.

16. STATUS DISPLAY

16.5.3 Selecting the Adjustment Step Resolution

To select the line or sample number adjustment step resolution for when the function dial (F•D) is turned, follow the procedure below.

Procedure

STATUS	→	F•2	SDI ANALYSIS or SDI / IP ANALYSIS	→	F•1	DATA DUMP	→	F•2	DUMP
OPERATION	→	F•2	FD 1CLICK: <u>1</u> / 10 / 50						

16.5.4 Selecting What the Function Dial Controls

To select whether the line number or sample number is controlled with the function dial (F•D), follow the procedure below. You can also change the line number using the V POS knob and the sample number using the H POS knob.

Procedure

STATUS	→	F•2	SDI ANALYSIS or SDI / IP ANALYSIS	→	F•1	DATA DUMP	→	F•2	DUMP
OPERATION	→	F•3	FD FUNCTION: <u>LINE</u> / SAMPLE						

Settings

LINE:	Turning the function dial (F•D) changes the line number. If you press the function dial (F•D), the data of line number 0 or 1 is displayed.
SAMPLE:	Turning the function dial (F•D) changes the sample number. If you press the function dial (F•D), EAV or sample number 0 is displayed.

16.5.5 Selecting the Display Mode

To select the data dump display mode, follow the procedure below.

Procedure

STATUS	→	F•2	SDI ANALYSIS or SDI / IP ANALYSIS	→	F•1	DATA DUMP	→	F•1	MODE: <u>RUN</u>
/ HOLD / FRM CAP									

Settings

RUN:	The input signal data is automatically updated and displayed.
HOLD:	The input signal data is displayed statically.
FRM CAP:	The frame data is displayed. If frame data has not been captured in the instrument, nothing is displayed. This setting can be selected in frame capture mode.

16. STATUS DISPLAY

16.5.6 Selecting the Display Format

To select the data dump display format, follow the procedure below.

This menu appears both in the DATA DUMP menu and DUMP OPERATION menu. However, when **F•5** LINK or **F•5** SUB is set to PICTURE, it does not appear.

Procedure

STATUS → **F•2** SDI ANALYSIS or SDI / IP ANALYSIS → **F•1** DATA DUMP → (**F•2**) DUMP OPERATION → **F•4** DISPLAY

: SERIAL / COMPO / BINARY (for HD, SD, 3G-A, HD (QL), 3G (QL) and 3G-A, 6G, 12G)

: PICTURE / STREAM1 / STREAM2 (for 3G-B-DL, 3G(QL) and 3G-B-DL)

: STREAM12 / STREAM1 / STREAM2 (for 3G(DL)-2K and 3G-B-DL)

: S1 SERIAL / S1 COMPO / S1 BINARY / S2 SERIAL / S2 COMPO / S2 BINARY (for 3G(DL)-4K, 3G-B DS)

Settings

SERIAL:	The parallel converted data sequences are displayed.
COMPO:	The parallel converted data sequences are divided into each component and displayed.
BINARY:	The parallel converted data sequences are displayed in binary.
PICTURE:	Links or streams 1 and 2 are combined and displayed in a picture structure.
STREAM1:	Stream 1 is displayed.
STREAM2:	Stream 2 is displayed.
STREAM12:	Streams 1 and 2 are combined and displayed.
S1 SERIAL:	Stream 1 is displayed serially.
S1 COMPO:	Stream 1 is separated and displayed.
S1 BINARY:	Stream 1 is displayed in binary.
S2 SERIAL:	Stream 2 is displayed serially.
S2 COMPO:	Stream 2 is separated and displayed.
S2 BINARY:	Stream 2 is displayed in binary.

DISPLAY = SERIAL

DATA DUMP		LINE No.1	Y	Cb/Cr
[EAV]		<1920>	3FF	3FF
[EAV]		<1921>	000	000
[EAV]		<1922>	000	000
[EAV]		<1923>	2D8	2D8
LN	LN	<1924>	204	204
LN	LN	<1925>	200	200
CRC	CRC	<1926>	2BB	2F7
CRC	CRC	<1927>	23C	1E8
	ADF	<1928>	040	000
	ADF	<1929>	040	3FF
	ADF	<1930>	040	3FF
	DID	<1931>	040	2E7
	DBN	<1932>	040	1A2
	DC	<1933>	040	218
	UDW	<1934>	040	18F
	UDW	<1935>	040	102
	UDW	<1936>	040	250
	UDW	<1937>	040	2D2
	UDW	<1938>	040	2C5
	UDW	<1939>	040	200

F1	F2	F3	F4	F5	F6	F7
DUMP OPERATION	MODE RUN		DISPLAY SERIAL		INPUT SELECT A	up menu

16. STATUS DISPLAY

DISPLAY = COMPO

DATA DUMP		LINE No.1	Y	Cb	Cr
[EAV]		<1920>	3FF	3FF	
[EAV]		<1921>	000		000
[EAV]		<1922>	000	000	
[EAV]		<1923>	2D8		2D8
LN	LN	<1924>	204	204	
LN	LN	<1925>	200		200
CRC	CRC	<1926>	2BB	2F7	
CRC	CRC	<1927>	23C		1E8
	ADF	<1928>	040	000	
	ADF	<1929>	040		3FF
	ADF	<1930>	040	3FF	
	DID	<1931>	040		2E7
	DBN	<1932>	040	2BE	
	DC	<1933>	040		218
	UDW	<1934>	040	1C4	
	UDW	<1935>	040		203
	UDW	<1936>	040	260	
	UDW	<1937>	040		2A0
	UDW	<1938>	040	2B1	
	UDW	<1939>	040		20F

F1 JUMP EAV
F2 FD 1CLICK 1
F3 FD FUNCTION LINE
F4 DISPLAY COMPO
F5
F6 USB MEMORY
F7 up menu

DISPLAY = BINARY

DATA DUMP		LINE No.1	Y	Cb/Cr
[EAV]		<1920>	1111111111	1111111111
[EAV]		<1921>	0000000000	0000000000
[EAV]		<1922>	0000000000	0000000000
[EAV]		<1923>	1011011000	1011011000
LN	LN	<1924>	1000000100	1000000100
LN	LN	<1925>	1000000000	1000000000
CRC	CRC	<1926>	1010111011	1011110111
CRC	CRC	<1927>	1000111100	0111101000
	ADF	<1928>	0001000000	0000000000
	ADF	<1929>	0001000000	1111111111
	ADF	<1930>	0001000000	1111111111
	DID	<1931>	0001000000	1011100111
	DBN	<1932>	0001000000	1000111100
	DC	<1933>	0001000000	1000011000
	UDW	<1934>	0001000000	1000100100
	UDW	<1935>	0001000000	1000000000
	UDW	<1936>	0001000000	1010100000
	UDW	<1937>	0001000000	1010011001
	UDW	<1938>	0001000000	1010011001
	UDW	<1939>	0001000000	1000001111

F1 JUMP EAV
F2 FD 1CLICK 1
F3 FD FUNCTION LINE
F4 DISPLAY BINARY
F5
F6 USB MEMORY
F7 up menu

Figure 16-12 Selecting the display format

16. STATUS DISPLAY

16.5.7 Selecting the Content to Display

When the link format is set to multi, 6G or 12G, to select which content to display the data dump of, follow the procedure below.

If you select PICTURE, the links and sub images are combined and displayed in a picture structure.

If you select LINK or SUB, the link or sub before combination is displayed in a transmission structure.

This menu appears both in the DATA DUMP menu and DUMP OPERATION menu.

Procedure (for multi link)

STATUS → F•2 SDI ANALYSIS or SDI / IP ANALYSIS → F•1 DATA DUMP → (F•2) DUMP OPERATION → F•5 LINK

: PICTURE / A[A] / B[B] / A[C] / B[D] / A / B (for HD(DL))

: PICTURE / 1[A] / 2[B] 1[C] / 2[D] / 1 / 2 (for 3G(DL))

: PICTURE / 1[A] / 2[B] / 3[C] / 4[D] (for 3G(QL), HD(QL))

Procedure (for 6G, 12G)

STATUS → F•2 SDI ANALYSIS or SDI / IP ANALYSIS → F•1 DATA DUMP → (F•2) DUMP OPERATION → F•5 SUB: PICTURE / 1[A] / 2[B] / 3[C] / 4[D]

16.5.8 Saving to a USB Memory Device

You can save the data dump to a USB memory device as a text file. The procedure to follow to save data is the same as the procedure that was given for the event log. See section 16.4.5, "Saving to a USB Memory Device."

Data dumps are saved in the DUMP folder.

- 📁 USB memory device
 - ↳ 📁 LV5600_USER or LV7600_USER
 - ↳ 📁 DUMP
 - ↳ 📄 YYYYMMDDhhmmss.txt

16.6 Configuring Phase Difference Measurement Settings

To show the phase difference measurement display, follow the procedure below.

You can use the phase difference measurement display to measure the phase difference between an SDI signal and an external sync signal or the phase difference between a pair of SDI signals.

During an IP signal measurement, you can measure the phase difference between PTP and various signals.

Procedure

STATUS	→	F•2	SDI ANALYSIS	→	F•2	EXT REF PHASE
--------	---	-----	--------------	---	-----	---------------

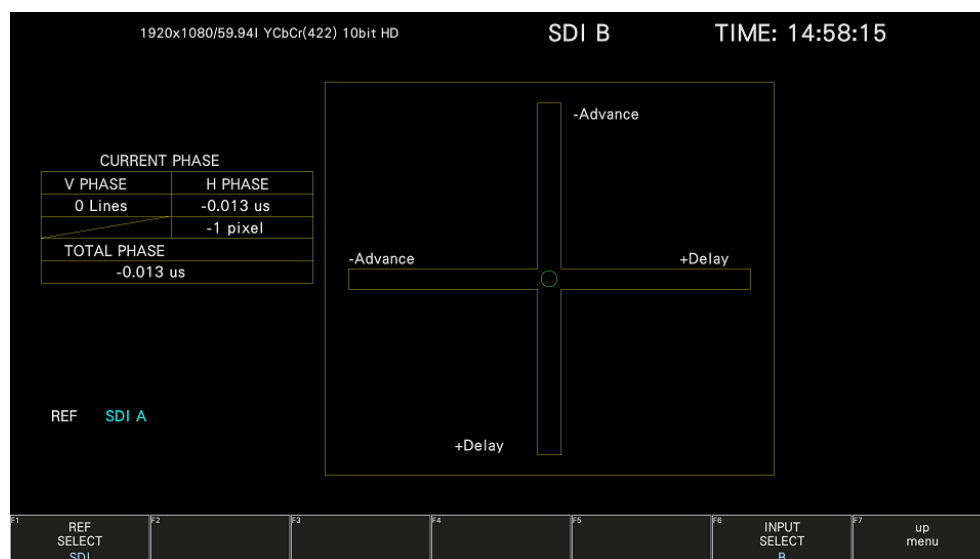

Figure 16-13 Phase difference measurement screen

- Measuring the Phase Difference between an SDI Signal and an External Sync Signal

You can measure the phase difference between an SDI signal and an external sync signal by setting **F•1** REF SELECT to EXT. Apply the external sync signal.

Note that the following input formats are not supported.

- 3G 720/30P, 720/29.97P, 720/25P, 720/24P, 720/23.98P
- Frame frequency 48P, 47.95P

- Measuring the Phase Difference between SDI Signals

You can measure the phase difference between SDI signals by setting **F•1** REF SELECT to SDI. This measurement is not possible when SDI System is set to 4K 12G, 4K 6G, or 2K 3G-B DS on the SYS > **F•1** SIGNAL IN OUT > SDI IN SETUP1 tab.

The reference signal varies depending on the input signal as shown below.

Figure 16-7 Reference signal

Input Signal	Reference Signal
SD, HD, 3G	Ach
HD(DL)	Link A
3G(DL)-2K, 3G(DL)-4K, 3G(QL), HD(QL)	Link 1

16. STATUS DISPLAY

- Phase difference measurement between the PTP and the RTP (SER05/SER06)

When the input is an IP signal (ST2110-20), the phase difference between PTP and RTP can be measured by setting **F•1** REF SELECT to PTP-RTP.

You can select the RTP port from PORT1 or PORT2 with **F•5** RTP PORT SELECT.

- Phase difference measurement between the PTP and an External Sync Signal (BB) (SER05/SER06)

When the input is an IP signal (ST2110-20), the phase difference between PTP and an External Sync Signal (BB) can be measured by setting **F•1** REF SELECT to PTP-BB.

- Phase difference measurement between the PTP and the FPT (SER06)

When the input is an IP signal (ST2110-20), the phase difference between PTP and FPT (First Packet Time) can be measured by setting **F•1** REF SELECT to PTP-FPT.

You can select the RTP port from PORT1 or PORT2 with **F•5** RTP PORT SELECT.

16.6.1 Phase Difference Measurement Screen Description

- CURRENT PHASE

V PHASE: The phase difference is displayed in units of lines.

H PHASE: The phase difference is displayed in units of time and in units of pixels or clocks. (*1)

TOTAL PHASE: The total of the V PHASE and H PHASE differences is displayed in units of time.

*1 When the input signal is HD(DL) 1080/60P, 1080/59.94P, 1080/50P or SD, the unit is clocks. Pixels are in units of the video's sampling frequency. Clocks are in units of the parallel video's transmission clock frequency.

16. STATUS DISPLAY

- REF

This displays the reference signal as shown below.

Table 16-8 REF indications

F•1 REF SELECT	Display	Description
EXT	EXT BB : DEFAULT	When the reference signal is BB and the phase difference is at the default value
	EXT BB : USER REF	When the reference signal is BB and the phase difference is at the user reference value
	EXT HD : DEFAULT	When the reference signal is HD3 and the phase difference is at the default value
	EXT HD : USER REF	When the reference signal is HD3 and the phase difference is at the user reference value
	NO SIGNAL	When no external sync signal is being applied
SDI	SDI A	When the input signal is SD, HD, or 3G and the reference signal is A
	LINK A	When the input signal is HD(DL) and the reference signal is link A
	LINK 1	When the input signal is 3G(DL)-2K, 3G(DL)-4K, 3G(QL), or HD(QL) and the reference signal is link 1
	SDI A NO SIGNAL	Indicates that the reference SDI signal is not being received.
PTP-RTP (SER05/SER06)	PTP	When the reference signal is PTP.
	NOT SUPPORT	When the input signal is other than ST2110-20/22.
	PTP NOT DETECT	When the reference PTP cannot be detected.
PTP-BB (SER05/SER06)	PTP	When the reference signal is PTP.
	NOT SUPPORT	When the input signal is other than ST2110-/22.
	PTP NOT DETECT	When the reference PTP cannot be detected.
PTP-FPT (SER06)	PTP	When the reference signal is PTP.
	NOT SUPPORT	When the input signal is other than ST2110-/22.
	PTP NOT DETECT	When the reference PTP cannot be detected.

- Setting the User-Defined Phase Difference Reference

When F•1 REF SELECT is set to EXT, you can set the current phase difference to zero by pressing F•2 REF SET USER. You can change the reference to match the system that you are using. (During multi link, the phase difference of link A or link 1 is set to zero.) To reset the phase difference to its default value (see below), press F•3 REF SET DEFAULT.

- Default Phase Difference Setting

If the input signal is HD or SD and F•1 REF SELECT is set to EXT, you can use F•4 0H TIMING to select the reference where the phase difference is assumed to be zero. When using a LEADER signal generator that allows you to select LEGACY or SERIAL, this setting must be matched to the setting selected on the instrument. In addition, depending on the output accuracy of the signal generator and measurement accuracy of the instrument, there may be an offset of around 0 ± 4 clocks in the display.

LEGACY: The phase difference is assumed to be zero when an external sync signal without a timing offset transmitted from a LEADER signal generator and an SDI signal are received.

SERIAL: The phase difference is zero when the external sync signal and the SDI signal are received at the times defined in the signal standard.

16. STATUS DISPLAY

- FORMAT:
- EXT FORMAT: (SER05/SER06)

Displays the external sync signal format when **F•1** REF SELECT is set to EXT or PTP-BB. This is not displayed when the external sync signal is not input.

- Graphical Display

The vertical axis represents the V phase difference in lines. The horizontal axis represents the H phase time difference. When the circles that represent V and H overlap with each other in the center, there is no phase difference.

The circles are normally displayed in white, but they will be displayed in green under the following circumstances.

Horizontal: When the circle is within ± 3 clocks of the center.

Vertical: When the circle is within ± 0 clocks of the center.

When the signal is behind the reference signal, the circle is displayed on the Delay (+) side. When the signal is ahead of the reference signal, the circle is displayed on the Advance (-) side. For both the V and H axes, differences of up to approximately $+1/2$ frames from the center are displayed on the Delay axis and differences of up to approximately $-1/2$ frames from the center are displayed on the Advance axis. See the following table for details.

When the phase difference between an SDI signal and an external sync signal is being measured, the H axis phase difference may vary within a range of ± 1 clock in cases such as when the signal is switched. When the phase difference between SDI signals is being measured, the H difference may vary within a range of ± 2 clock in cases such as when the signal is switched.

16. STATUS DISPLAY

Table 16-9 Delay and Advance axis display ranges (3G-A, 3G-B, HD, SD)

3G-A, 3G-B, HD, SD Format		Displayed on the Advance Axis					Displayed on the Delay Axis			
		V PHASE	H PHASE		V PHASE	H PHASE		V PHASE	H PHASE	
		[Lines]	[us]		[Lines]	[us]		[Lines]	[us]	
3G-A	1080/59.94P	-562	-14.822	to	0	0	to	562	0	
	1080/60P	-562	-14.808	to	0	0	to	562	0	
	1080/50P	-532	-17.771	to	0	0	to	562	0	
3G-B	1080/59.94P	-1124	-14.822	to	0	0	to	1125	0	
	1080/60P	-1124	-14.808	to	0	0	to	1125	0	
	1080/50P	-1124	-17.771	to	0	0	to	1125	0	
3G-A 3G-B HD	1080/59.94I, 1080/29.97P, 1080/29.97PsF	-562	-29.645	to	0	0	to	562	0	
	1080/60I, 1080/30P, 1080/30PsF	-562	-29.616	to	0	0	to	562	0	
	1080/50I, 1080/25P, 1080/25PsF	-562	-35.542	to	0	0	to	562	0	
	1080/23.98P, 1080/23.98PsF	-562	-37.060	to	0	0	to	562	0	
	1080/24P, 1080/24PsF	-562	-37.023	to	0	0	to	562	0	
	720/59.94P	-375	0	to	0	0	to	374	22.230	
	720/60P	-375	0	to	0	0	to	374	22.208	
	720/50P	-375	0	to	0	0	to	374	26.653	
	720/29.97P	-375	0	to	0	0	to	374	44.475	
	720/30P	-375	0	to	0	0	to	374	44.430	
	720/25P	-375	0	to	0	0	to	374	53.319	
	720/23.98P	-375	0	to	0	0	to	374	55.597	
	720/24P	-375	0	to	0	0	to	374	55.542	
	SD	525/59.94I	-262	-63.518	to	0	0	to	262	0
		625/50I	-312	-63.962	to	0	0	to	312	0

16. STATUS DISPLAY

Table 16-10 Delay and Advance axis display ranges (6G)

6G Sub Image Format		Displayed on the Advance Axis								
					Displayed on the Delay Axis					
		V PHASE [Lines]	H PHASE [us]		V PHASE [Lines]	H PHASE [us]		V PHASE [Lines]	H PHASE [us]	
6G	1080/29.97P	-562	-29.645	to	0	0	to	562	0	
	1080/30P	-562	-29.616	to	0	0	to	562	0	
	1080/25P	-562	-35.542	to	0	0	to	562	0	
	1080/23.98P	-562	-37.060	to	0	0	to	562	0	
	1080/24P	-562	-37.023	to	0	0	to	562	0	

Table 16-11 Delay and Advance axis display ranges (12G)

12G Sub Image Format		Displayed on the Advance Axis								
					Displayed on the Delay Axis					
		V PHASE [Lines]	H PHASE [us]		V PHASE [Lines]	H PHASE [us]		V PHASE [Lines]	H PHASE [us]	
12G	1080/59.94P	-562	-14.822	to	0	0	to	562	0	
	1080/60P	-562	-14.808	to	0	0	to	562	0	
	1080/50P	-532	-17.771	to	0	0	to	562	0	
	1080/29.97P	-562	-29.645	to	0	0	to	562	0	
	1080/30P	-562	-29.616	to	0	0	to	562	0	
	1080/25P	-562	-35.542	to	0	0	to	562	0	
	1080/23.98P	-562	-37.060	to	0	0	to	562	0	
	1080/24P	-562	-37.023	to	0	0	to	562	0	

16.7 Setting the Lip Sync Measurement (SER03)

To show the lip sync measurement screen, follow the procedure below.

By combining a Leader signal generator that supports lip syncing with this instrument, you can use the lip sync measurement screen to measure the offset between the video signal and the audio signal that occurs in the transfer route.

When an SER05 or SER06 is installed, the SDI ANALYSIS becomes the SDI/IP ANALYSIS menu. Procedure

STATUS	→	F•2	SDI ANALYSIS or SDI / IP ANALYSIS	→	F•3	AV PHASE
--------	---	-----	-----------------------------------	---	-----	----------

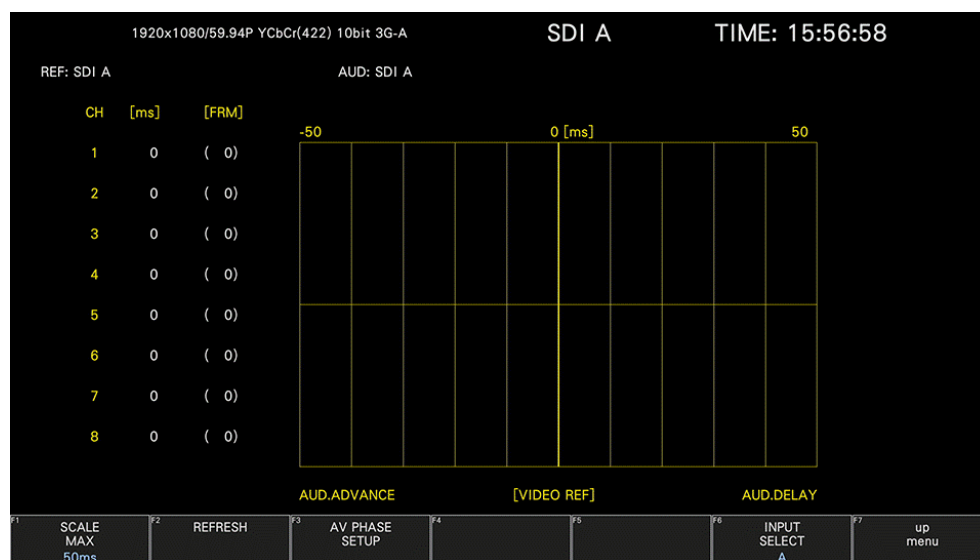

Figure 16-14 Lip sync measurement screen

As an example, below is the procedure for when the LT4600A, LT4610 (with LT4610-SER02 and LT4610-SER24 installed according to the format), or LT4611 (with LT4610-SER22 installed and LT4610-SER02 and LT4611-SER24 installed according to the format) is used for the signal generator with a lip sync feature when the audio output is set to SDI embedded audio.

1. Turn the signal generator that supports lip syncing lip sync feature on.
 - On the LT4600A

Select SDI SETTING→SDI→LIPSYNC to turn lip sync on. Select AES/EBU SETTING→AES/EBU 1→LIPSYNC ENABLE to set the audio. For details, see the LT4600A instruction manual.
 - On the LT4610 or LT4611

Depending on the format, select ETC→LIPSYNC→SDI1+AES / SDI2 or 12G OPTION→SDI 1 / 2 / 3 / 4→VIDEO→LIPSYNC to turn lip sync on. Then, select SDI→SDI1 / 2→AUDIO or 12G OPTION→SDI 1 / 2 / 3 / 4→AUDIO to set the audio. For details, see the LT4610 / LT4611 instruction manual.

16. STATUS DISPLAY

2. Send the signal generated from the signal generator that supports lip syncing SDI output connector to the transfer route. Apply the signal received from the transfer route to the SDI connector of this instrument.

If the output audio is external audio, apply the video signal to the SDI input connector and the audio signal to the digital audio I/O connector.

3. Select the audio signal.

On the instrument's **AUDIO** → **F•7** MAPPING → TARGET tab, set the audio signal to EMB AUDIO (for embedded audio) or EXT AUDIO (for digital audio I/O connector). For EXT AUDIO, EXTERNAL AUDIO on the AUDIO IN/OUT tab must be set to INPUT.

4. The lip sync measurement screen is displayed.

Press **STATUS** → **F•2** SDI ANALYSIS or SDI / IP ANALYSIS → **F•3** AV PHASE.

The time difference when the luminance level of the video signal (the G signal level when the input signal is RGB) exceeds the specified value or when the audio level signal exceeds the specified value is measured, and the results are displayed numerically and graphically for each channel.

The measured value is displayed in units of time and frames. If the audio signal cannot be detected, "UNLOCK" is displayed. If the audio signal cannot be measured correctly, "MISSING" is displayed. Further, when the measured value is updated, an asterisk is displayed next to the channel.

You can set the video signal measurement range, video signal luminance level, and audio signal level using **F•3** AV PHASE SETUP.

16.7.1 Selecting the Measurement Range

To select the graph measurement range, follow the procedure below.

Procedure

STATUS	→	F•2	SDI ANALYSIS or SDI / IP ANALYSIS	→	F•3	AV PHASE	→	F•1	SCALE MAX:
<u>50ms / 100ms / 500ms / 1.0s / 2.5s</u>									

16.7.2 Updating the Measurement Screen

To update the measurement screen, follow the procedure below.

Procedure

STATUS	→	F•2	SDI ANALYSIS or SDI / IP ANALYSIS	→	F•3	AV PHASE	→	F•2	REFRESH
---------------	---	------------	-----------------------------------	---	------------	----------	---	------------	---------

16. STATUS DISPLAY

16.7.3 Setting the Measurement Range

To set the measurement range, follow the procedure below. Use the AV PHASE SETUP tab to configure these settings.

Procedure

STATUS → F•2 SDI ANALYSIS or SDI / IP ANALYSIS → F•3 AV PHASE → F•3 AV PHASE SETUP

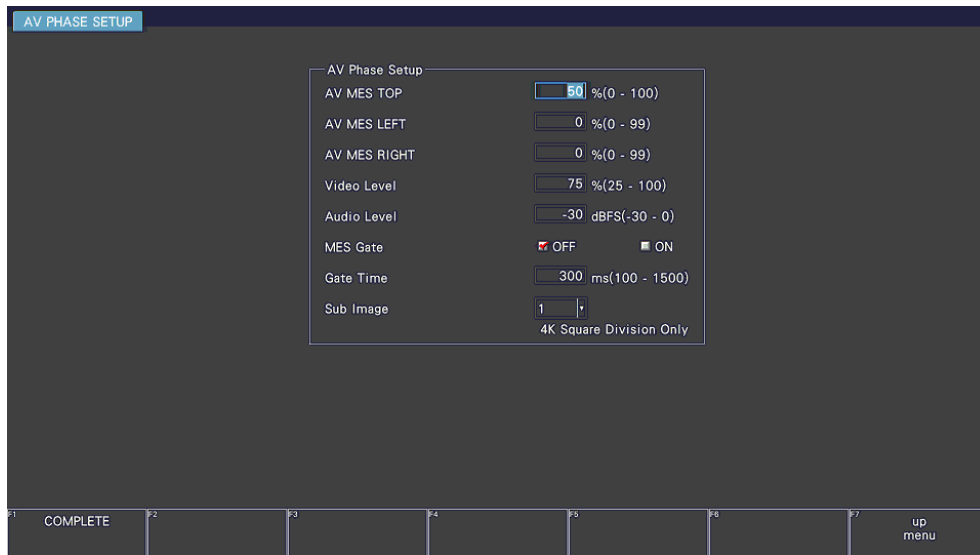

Figure 16-15 AV PHASE SETUP tab

- AV MES TOP

Set the video signal measurement line with the top edge of the picture taken to be 0 % and the bottom edge to be 100 %.

You can also set this using LINE SELECT on the PIC menu while viewing the picture.

[See also] 13.10.3, "Setting the Lip Sync Measurement Range (SER03)"

0 - 50 - 100%

- AV MES LEFT

Set the video signal measurement range (left side) with the left edge of the picture taken to be 0 % and the right edge to be 100 %. You cannot set this to the right of the line set with AV MES RIGHT.

You can also set this using LINE SELECT on the PIC menu while viewing the picture.

[See also] 13.10.3, "Setting the Lip Sync Measurement Range (SER03)"

0 - 99%

16. STATUS DISPLAY

- AV MES RIGHT

Set the video signal measurement range (right side) with the right edge of the picture taken to be 0 % and the left edge to be 100 %. You cannot set this to the left of the line set with AV MES LEFT.

You can also set this using LINE SELECT on the PIC menu while viewing the picture.

[See also] 13.10.3, "Setting the Lip Sync Measurement Range (SER03)"

0 - 99%

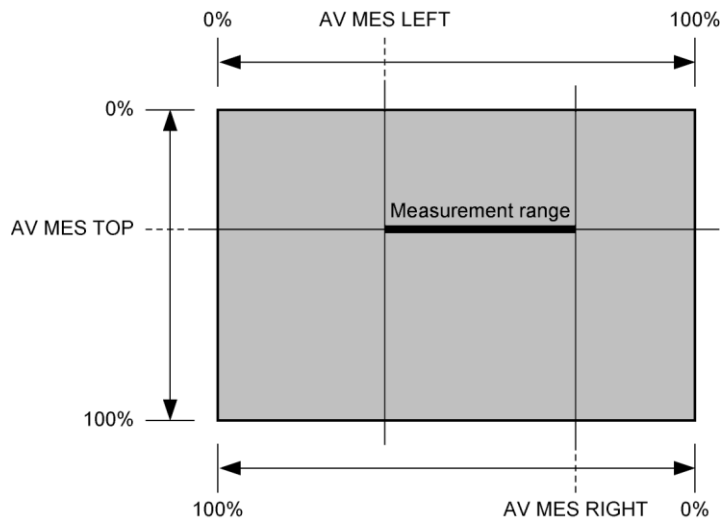

Figure 16-16 Setting the measurement range (video signal)

- Video Level

Set the video signal luminance level. The time difference from the audio signal is measured when the luminance level of the measurement range specified with AV MES exceeds the level specified here.

25 - 75 - 100%

- Audio Level

Set the audio signal level. The time difference from the video signal is measured when the audio signal level exceeds the level specified here.

-30 - 0dBFS

- MES Gate

Select whether to specify the measurement range of the audio signal. Set this to ON such as when using a pattern containing multiple audio signals for a single video signal.

OFF / ON

16. STATUS DISPLAY

- Gate Time

When MES Gate is set to ON, set the measurement range of the audio signal. The measurement range is "the rise time of the video signal \pm the time set with Gate Time."

100 - 300 - 1500

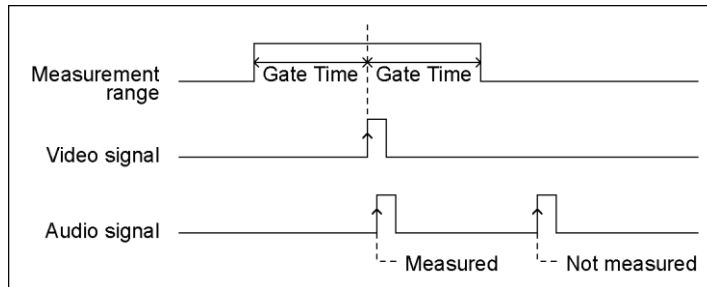

Figure 16-17 Setting the measurement range (audio signal)

- Sub ImageLink

When the input signal is 3G(QL) and square format, select the link for setting the measurement range.

1 / 2 / 3 / 4

16.8 Configuring the IP Screen (SER05/SER06)

16.8.1 Displaying the IP Status Screen

To view the IP status screen, follow the procedure below.

Procedure

STATUS → F•2 SDI / IP ANALYSIS → F•4 IP

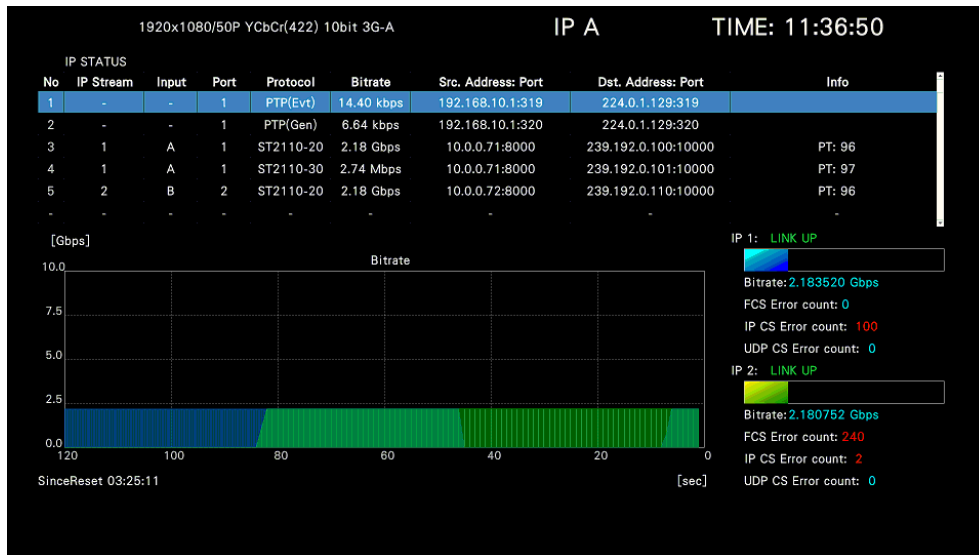

Figure 16-18 IP status screen

- IP Stream List

Up to 32 streams contained in the IP input signal are displayed.

By turning the function dial (F•D) to the right, you can scroll the screen to view all the streams. Also, if you press the function dial (F•D), the first stream is displayed.

Streams that are currently being received are displayed in white. Streams that were being received in the past are displayed in gray. You can clear past streams by pressing **F•2** LIST CLEAR.

- No

The data number (1 to 32) is displayed.

- IP Stream

The IP stream number (1 to 4) is displayed.

- Input

The channel that the selected stream is assigned to (A to D) is displayed.

- Port

The port number (1 or 2) is displayed.

16. STATUS DISPLAY

- Protocol

The protocol is displayed.

If the Type in the IP SETUP1 tab of the system settings is ST2110 JXS and one of the following conditions is met, it will be displayed in yellow to call attention.

- When ST2110-20 (uncompressed) is received in stream 1 with JPEG XS Decode on the IP SETUP2 tab turned ON.
- When ST2110-22 (JPEG XS) is received in stream 2 with JPEG XS Decode on the IP SETUP2 tab turned ON.
- When ST2110-22 (JPEG XS) is received with JPEG XS Decode on the IP SETUP2 tab turned OFF.

- Src. Address: Port

The source IP address and port number are displayed.

- Dst. Address: Port

The destination IP address and port number are displayed.

- Info

VLAN availability and RTP payload type are displayed.

- Bitrate

The IP 1/2 bit rate is plotted in a chart. IP 1 and IP 2 are displayed in blue and green, respectively.

- SinceReset

The time that has elapsed since **F•7** ERROR CLEAR was pressed, the instrument was initialized, or the instrument was restarted is displayed.

- IP 1/2

“LINK UP” is displayed in green when communication is up. Otherwise, “LINK DOWN” is displayed in red.

- Bitrate

The bit rate is displayed numerically.

- FCS Error count

The number of FCS errors is displayed.

- IP CS Error count

The number of IP checksum errors is displayed.

- UDP CS Error count

The number of UDP checksum errors is displayed.

16.8.2 Configuring the IP Status Screen

- Selecting the IP Measurement

To select the IP measurement, follow the procedure below.

Procedure

STATUS → F•2 SDI / IP ANALYSIS → F•4 IP → F•1 IP MEAS

- F•1 PACKET JITTER
- F•2 PTP
- F•3 TIMING COMPARISON
- F•4 PATH DELAY
- F•5 next menu

- F•1 SFP
- F•2 PACKET HEADER
- F•3 BUFFER/FPT
- F•4 NMOS
- F•5 prev menu / next menu

- F•1 JPEG XS STATUS
 - F•2 JPEG XS HEADER
 - F•3 FORMAT COMPARISON
 - F•5 prev menu
-

Settings

PACKET JITTER: The packet jitter screen is displayed.

PTP: The PTP status screen is displayed.

TIMING COMPARISON:

The PTP timing comparison screen is displayed.

PATH DELAY: The path delay screen is displayed.

SFP: The SFP information screen is displayed.

PACKET HEADER: The packet header screen is displayed.

BUFFER/FPT: The packet buffer screen is displayed.

NMOS: The NMOS screen is displayed.

JPEG XS STATUS: JPEG XS status screen is displayed. This menu is displayed when measuring JPEG XS.

JPEG XS HEADER: JPEG XS header screen is displayed. This menu is displayed when measuring JPEG XS.

FORMAT COMPARISON:

Format comparison screen is displayed. This menu is displayed when measuring JPEG XS.

16. STATUS DISPLAY

- Clearing the Chart

To clear the chart, and error counts, follow the procedure below.

Procedure

STATUS	→	F•2	SDI / IP ANALYSIS	→	F•4	IP	→	F•2	CHART CLEAR
--------	---	-----	-------------------	---	-----	----	---	-----	-------------

- Setting the Chart

To display the chart setup menu, follow the procedure below.

[See also] 16.8.21, "Configuring the Chart Setup Menu."

Procedure

STATUS	→	F•2	SDI / IP ANALYSIS	→	F•4	IP	→	F•4	CHART SETUP
--------	---	-----	-------------------	---	-----	----	---	-----	-------------

- Setting the IP Stream

To display the stream setup menu, follow the procedure below.

[See also] 16.8.22, "Configuring the Stream Setup Menu."

Procedure

STATUS	→	F•2	SDI / IP ANALYSIS	→	F•4	IP	→	F•5	IP STREAM SETUP
--------	---	-----	-------------------	---	-----	----	---	-----	-----------------

16.8.3 Displaying the Packet Jitter Screen

To display the packet jitter screen, follow the procedure below.

The packet arrival intervals of the IP stream are measured and the fluctuations over time are displayed graphically.

If Type is set to ST2110, ST2110 TSG, or ST2110 JXS on the IP SETUP1 tab in the SYS menu, the packet arrival interval can be measured for each of VIDEO, AUDIO, and ANC.

Procedure

STATUS	→	F•2	SDI / IP ANALYSIS	→	F•4	IP	→	F•1	IP MEAS	→	F•1	PACKET JITTER
--------	---	-----	-------------------	---	-----	----	---	-----	---------	---	-----	---------------

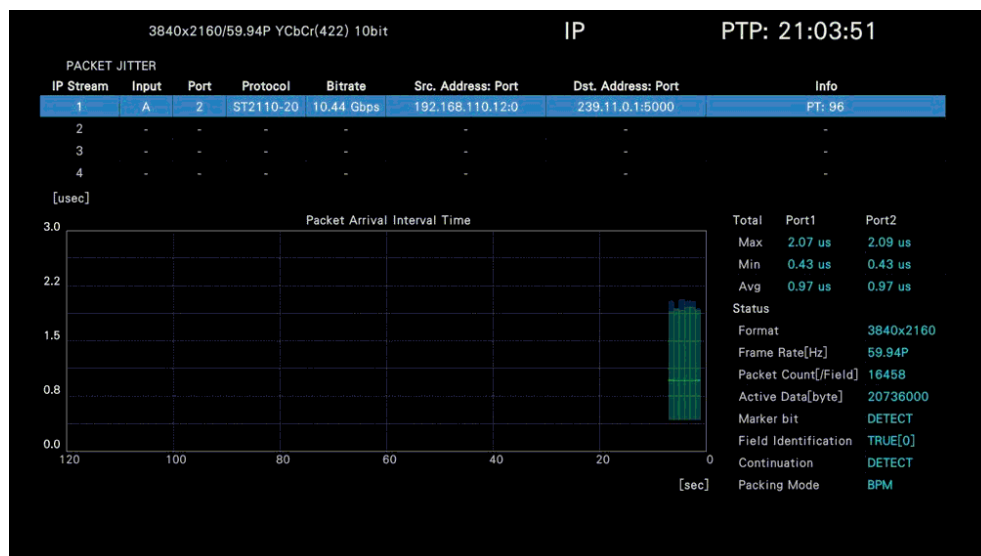

Figure 16-19 Packet jitter screen

16. STATUS DISPLAY

- IP Stream List

The IP stream (1 to 4) data is displayed. Use **F•5** IP STREAM SELECT to select the IP stream.

- Packet Arrival Interval Time

The packet arrival intervals are plotted on a chart. The maximum and minimum values within the last second are indicated in green and the average in blue. If a video packet is missing or the order is changed, it will be displayed in red.

- Total

The packet arrival intervals from when the measurement was started to the present are displayed. Port 1 and port 2 are displayed at the same time.

Max and Min indicate maximum and minimum values, respectively. Avg indicates the average value.

- Status

The format is displayed when Type is set to ST2110, ST2110 TSG, or ST2110 JXS on the IP SETUP1 tab of the SYS menu.

- Format

The resolution is displayed. If the resolution cannot be detected "UNKNOWN" is displayed in yellow.

- Frame Rate[Hz]

Frame (field) frequency is displayed. If frame (field) frequency cannot be detected "UNKNOWN" is displayed in yellow.

- Packet Count[/Field]

The number of packets per frame (field) is displayed.

- Active Data[byte]

The number of video data (bytes) per frame (field) is displayed.

- Marker bit

If the marker bit is detected, "DETECT" is displayed. Otherwise, "MISSING" is displayed in yellow.

- Field Identification

If the signal is progressive, "TRUE[0]" is displayed when Field Identification is 0 and "FALSE[1]" in yellow when it is 1.

If the signal is interlace, "TRUE[1]" is displayed when Field Identification is 1 and "FALSE[0]" in yellow when it is 0.

- Continuation

During packetization, "DETECT" is displayed when the input signal is set to cross over lines or "MISSING" is displayed otherwise.

- Packing Mode

When the packet length is fixed, "BPM" (Block Packing Mode) is displayed. When it varies, "GPM" (General Packing Mode) is displayed.

16.8.4 Configuring the Packet Jitter Screen

- Selecting the Measurement Mode

To select the measurement mode, follow the procedure below.

If Type is set to ST2110, ST2110 TSG, or ST2110 JXS on the IP SETUP1 tab in the SYS menu, you can select.

Procedure

STATUS	→	F•2	SDI / IP ANALYSIS	→	F•4	IP	→	F•1	IP MEAS	→	F•1	PACKET JITTER	→
F•1			MODE:										
			<u>VIDEO ACTIVE</u>										

Settings

VIDEO ACTIVE: The arrival interval of video packets excluding the interval across video frames is displayed.

VIDEO ALL: The arrival interval of video packets including the interval across video frames is displayed.

AUDIO: The arrival interval of audio packets is displayed.

ANC The arrival interval of ANC packets is displayed.

- Clearing the Chart

To clear the chart and measurement values, follow the procedure below.

Procedure

STATUS	→	F•2	SDI / IP ANALYSIS	→	F•4	IP	→	F•1	IP MEAS	→	F•1	PACKET JITTER	→
F•2			CHART CLEAR										

- Selecting the IP Stream

To select the IP stream to be measured, follow the procedure below.

Procedure

STATUS	→	F•2	SDI / IP ANALYSIS	→	F•4	IP	→	F•1	IP MEAS	→	F•1	PACKET JITTER	→
F•5			IP STREAM SELECT:										
			<u>STREAM1</u>										

16. STATUS DISPLAY

16.8.5 Displaying the PTP Status Screen

To view the PTP status screen, follow the procedure below.

The PTP time and network delay information are displayed graphically.

In addition, the grandmaster clock information obtained from the PTP announce message is displayed.

The grandmaster is selected by BMCA (Best Master Clock Algorithm) based on this information.

Procedure

STATUS	→	F•2	SDI / IP ANALYSIS	→	F•4	IP	→	F•1	IP MEAS	→	F•2	PTP
--------	---	-----	-------------------	---	-----	----	---	-----	---------	---	-----	-----

MODE = DELAY TIME

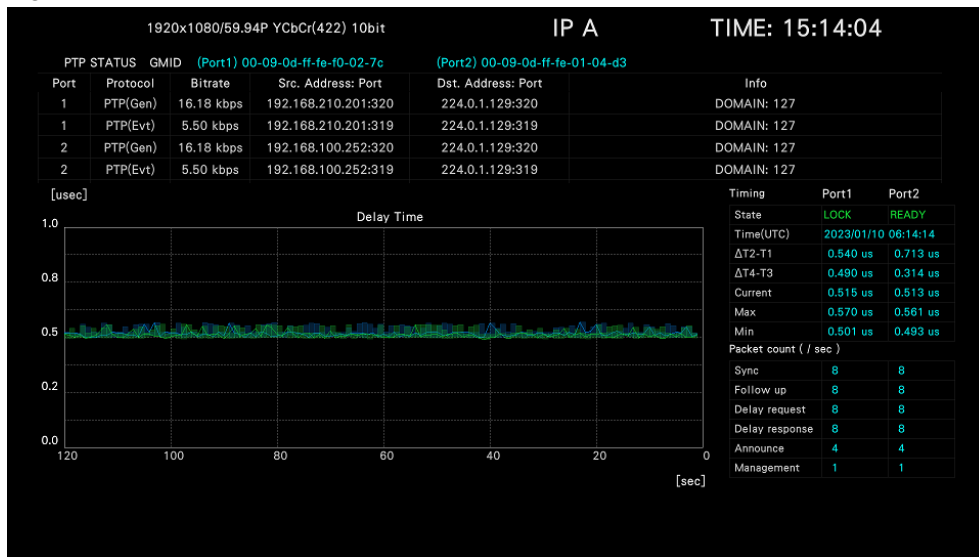

MODE = TIME OFFSET

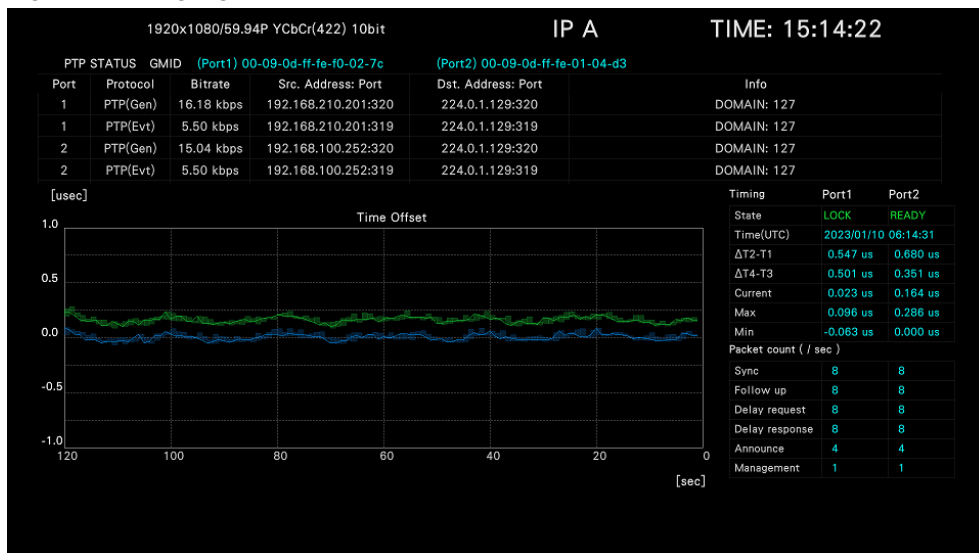

16. STATUS DISPLAY

MODE = INFO

PTP STATUS				GMID (Port1) 00-09-0d-ff-fe-f0-02-7c		(Port2) 00-09-0d-ff-fe-01-04-d3		IP A	TIME: 16:27:00
Port	Protocol	Bitrate	Src. Address: Port	Dst. Address: Port		Info			
1	PTP(Gen)	16.18 kbps	192.168.210.201:320	224.0.1.129:320		DOMAIN: 127			
1	PTP(Evt)	5.50 kbps	192.168.210.201:319	224.0.1.129:319		DOMAIN: 127			
2	PTP(Gen)	16.18 kbps	192.168.100.252:320	224.0.1.129:320		DOMAIN: 127			
2	PTP(Evt)	5.50 kbps	192.168.100.252:319	224.0.1.129:319		DOMAIN: 127			

PTP Info				Timing	
Port1		Port2		Port1	Port2
Name	Value	Name	Value	State	
DomainNumber	127	DomainNumber	127	READY	LOCK
OriginTimestamp	0(sec) 0(nsec)	OriginTimestamp	0(sec) 0(nsec)	Time(UTC)	2023/01/10 07:27:09
UTC Offset	37	UTC Offset	37	ΔT2-T1	30.227 us 0.550 us
Priority1	1	Priority1	0	ΔT4-T3	-29.197 us 0.498 us
ClockClass	248	ClockClass	220	Current	29.712 us 0.026 us
ClockAccuracy	> 10s	ClockAccuracy	> 10s	Max	27.128 us 0.070 us
ClockVariance	15652	ClockVariance	15652	Min	-0.208 us -0.056 us
Priority2	128	Priority2	128	Packet count (/ sec)	
ClockIdentity	00090dfffef0027c	ClockIdentity	00090dfffef0104d3	Sync	8 8
StepsRemoved	1	StepsRemoved	1	Follow up	8 8
TimeSource	HAND_SET	TimeSource	alternate PTP profile[0xf0]	Delay request	8 8
				Delay response	8 8
				Announce	4 4
				Management	1 1

Figure 16-20 PTP status screen

- PTP Packet List

PTP packet data is displayed.

- Delay Time / Time Offset

The delay time or time difference is plotted on a chart. The maximum and minimum values within the last second are indicated in green. The measurement values for each second are displayed in blue.

- PTP Info

The grandmaster clock information obtained from the PTP announce message is displayed. Port 1 and port 2 are displayed at the same time.

- DomainNumber

The domain number is displayed.

- OriginTimestamp

The value of ± 1 against the local time of the source clock of the announcement message is entered. It is usually 0.

- UTC Offset

The UTC offset value of the time information is indicated.

- Priority1

The BMCA priority of the grandmaster clock is indicated.

- ClockClass

The time source acquisition status of the grandmaster clock is indicated.

- ClockAccuracy

The accuracy of the grandmaster clock is indicated.

16. STATUS DISPLAY

- ClockVariance
The variance of the Grandmaster clock is indicated.
- Priority2
The BMCA priority of the grandmaster clock is indicated.
- ClockIdentity
The grandmaster clock ID is indicated.
- StepsRemoved
The number of communication paths between the local clock and the grandmaster clock is indicated.
- TimeSource
The time source of the grandmaster clock is indicated.
- Timing
Port 1 and port 2 are displayed at the same time.
- State
The PTP lock state is displayed as one of the following.
When receiving PTP on ports 1 and 2, BMCA selects the port to use for synchronization based on the information of the grandmaster clock of each port.

LOCK:	Displayed in green when the port is used for synchronization and the Time Offset is less than $\pm 1\mu\text{s}$.
READY:	Displayed when the port is not used for synchronization. When the time difference is less than $\pm 1\mu\text{s}$ from the locked PTP, it is displayed in green, and when the time difference is more than $\pm 1\mu\text{s}$, it is displayed in yellow.
UNLOCK:	Displayed in red when the Time Offset is $\pm 1\mu\text{s}$ or more.
Not Detect:	Displayed in red when PTP packets cannot be detected.

- Time(UTC)
The UTC time is displayed.

16. STATUS DISPLAY

- $\Delta T2-T1 / \Delta T4-T3$

The time for a message to be sent from the master to the slave ($\Delta T2-T1$) and the time for a message to be sent from the slave to the master ($\Delta T4-T3$) are displayed.

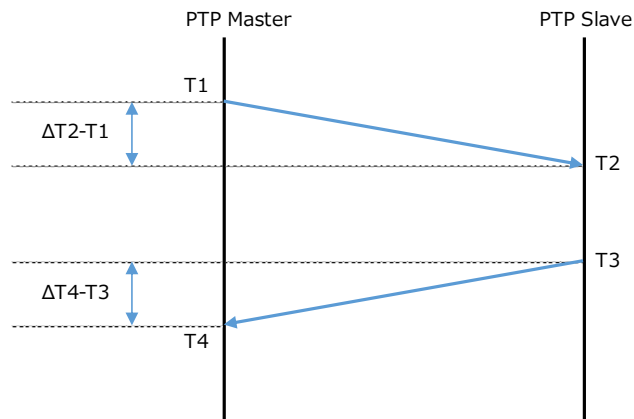

- Current / Max / Min

Based on the following equations, the delay time or time difference is displayed. Current indicates the measured values for each second. Max and Min indicate the maximum and minimum values within the past second, respectively.

$$\text{Delay time} = \{(\Delta T2-T1) + (\Delta T4-T3)\} / 2$$

$$\text{Time difference} = \{(\Delta T2-T1) - (\Delta T4-T3)\} / 2$$

Normally, it is displayed in cyan, but when the measurement mode is TIME OFFSET or INFO and State is yellow READY display, it is displayed in yellow.

- Packet count (/ sec)

Measured values for Sync, Follow up, Delay request, Delay response, Announce, and Management packets are displayed for each second.

Port 1 and port 2 are displayed at the same time.

16.8.6 Configuring the PTP Status Screen

- Selecting the Measurement Mode

To select the measurement mode, follow the procedure below.

Procedure

STATUS → F.2 SDI / IP ANALYSIS → F.4 IP → F.1 IP MEAS → F.2 PTP → F.4 MODE:
 DELAY TIME / TIME OFFSET / INFO

Settings

DELAY TIME: The delay time is displayed.
 TIME OFFSET: The time difference is displayed.
 INFO: The grandmaster clock information obtained from the PTP announce message is displayed.

- Clearing the Chart

To clear the chart and measurement values, follow the procedure below.

This menu is not displayed when the measurement mode is set to INFO.

Procedure

STATUS → F.2 SDI / IP ANALYSIS → F.4 IP → F.1 IP MEAS → F.2 PTP → F.2 CHART
 CLEAR

- Selecting the scale

To select the vertical scale, follow the procedure below.

This menu is not displayed when the measurement mode is set to INFO.

Procedure

STATUS → F.2 SDI / IP ANALYSIS → F.4 IP → F.1 IP MEAS → F.2 PTP → F.3 SCALE
 [usec]: 0.5 - 10.0 (0.5 steps) / AUTO

- Setting the Chart

To display the chart setup menu, follow the procedure below.

[See also] 16.8.21, "Configuring the Chart Setup Menu."

This menu is not displayed when the measurement mode is set to INFO.

Procedure

STATUS → F.2 SDI / IP ANALYSIS → F.4 IP → F.1 IP MEAS → F.2 PTP → F.4 CHART
 SETUP

16. STATUS DISPLAY

16.8.7 Displaying the PTP Timing Comparison Screen

If Type is set to ST2110, ST2110 TSG, or ST2110 JXS on the IP SETUP1 tab of the SYS menu, to display the PTP timing comparison screen, follow the procedure below.

The PTP timing comparison screen shows the comparison of the timings of the RTP video, audio, and ancillary signals relative to the PTP.

For chart display, you can select port 1, port 2, or both.

For numerical display, ports 1 and 2 are displayed at the same time.

Use **F•1** MODE to turn on and off the video, audio, and ancillary signals.

Procedure

STATUS → **F•2** SDI / IP ANALYSIS → **F•4** IP → **F•1** IP MEAS → **F•3** TIMING COMPARISON

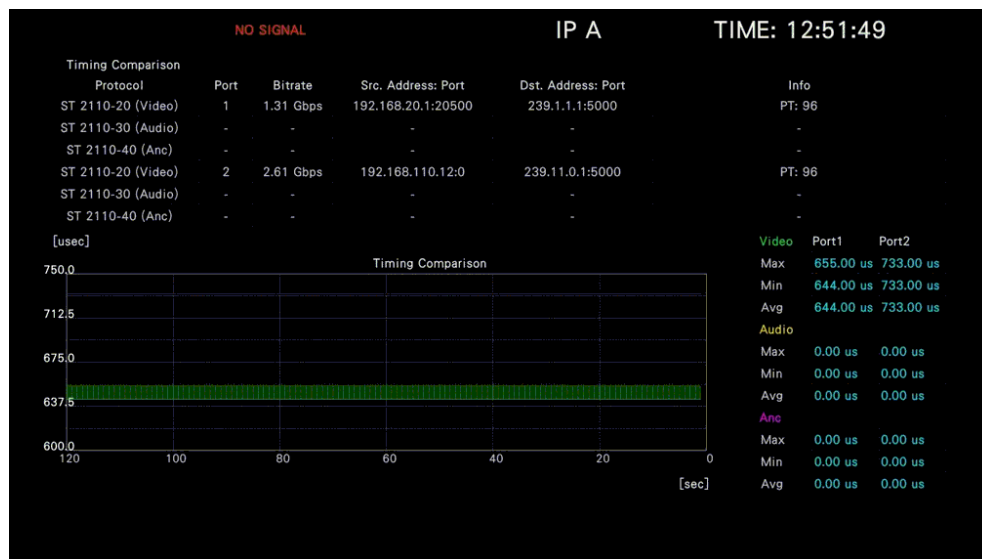

Figure 16-21 PTP timing comparison screen

16.8.8 Configuring the PTP Timing Comparison Screen

- Selecting the Measurement Mode

To select the measurement mode, follow the procedure below.
Either VIDEO, AUDIO, or ANC is turned on.

Procedure

STATUS → F•2 SDI / IP ANALYSIS → F•4 IP → F•1 IP MEAS → F•3 TIMING
COMPARISON → F•1 MODE
→ F•1 VIDEO: ON / OFF
→ F•2 AUDIO: ON / OFF
→ F•3 ANC: ON / OFF

- Clearing the Chart

To clear the chart and measurement values, follow the procedure below.

Procedure

STATUS → F•2 SDI / IP ANALYSIS → F•4 IP → F•1 IP MEAS → F•3 TIMING
COMPARISON → F•2 CHART CLEAR

- Setting the Chart

To display the chart setup menu, follow the procedure below.
[See also] 16.8.21, "Configuring the Chart Setup Menu."

Procedure

STATUS → F•2 SDI / IP ANALYSIS → F•4 IP → F•1 IP MEAS → F•3 TIMING
COMPARISON → F•4 CHART SETUP

- Selecting the IP Stream

To select the IP stream you will measure, follow the procedure below.

Procedure

STATUS → F•2 SDI / IP ANALYSIS → F•4 IP → F•1 IP MEAS → F•3 TIMING
COMPARISON → F•5 IP STREAM SELECT: STREAM1 / STREAM2 / STREAM3 / STREAM4

16. STATUS DISPLAY

16.8.9 Displaying the Path Delay Screen

If Redundancy Mode is set to ON on the IP SETUP1 tab in the SYS menu, to display the path delay screen, follow the procedure below.

The path delay screen shows the measurement of the packet arrival time difference between IP signal ports.

Procedure

STATUS → F•2 SDI / IP ANALYSIS → F•4 IP → F•1 IP MEAS → F•4 PATH DELAY

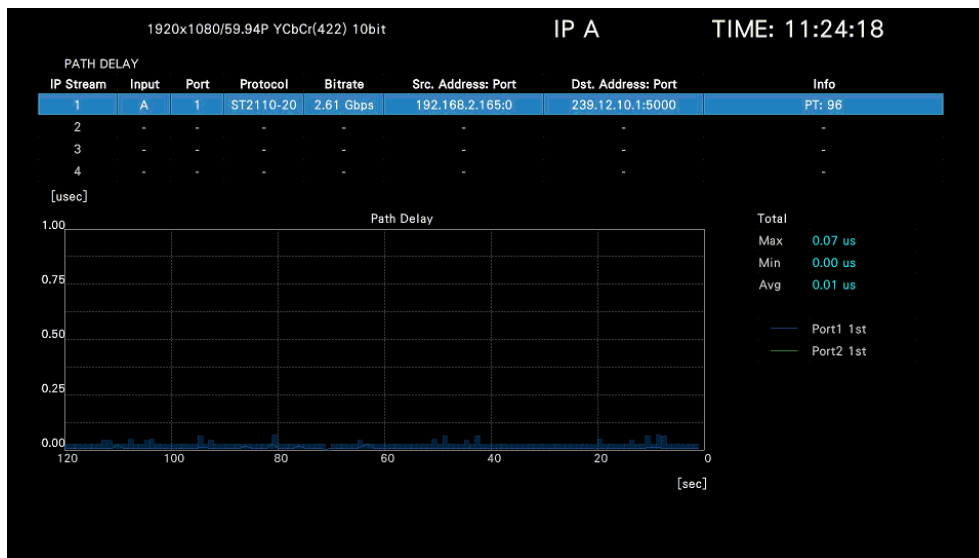

Figure 16-22 Path delay screen

16.8.10 Configuring the Path Delay Screen

• Clearing the Chart

To clear the chart and measurement values, follow the procedure below.

Procedure

STATUS → F•2 SDI / IP ANALYSIS → F•4 IP → F•1 IP MEAS → F•4 PATH DELAY → F•2 CHART CLEAR

• Setting the Chart

To display the chart setup menu, follow the procedure below.

[See also] 16.8.21, "Configuring the Chart Setup Menu."

Procedure

STATUS → F•2 SDI / IP ANALYSIS → F•4 IP → F•1 IP MEAS → F•4 PATH DELAY → F•4 CHART SETUP

• Selecting the IP Stream

To select the IP stream you will measure, follow the procedure below.

Procedure

STATUS → F•2 SDI / IP ANALYSIS → F•4 IP → F•1 IP MEAS → F•4 PATH DELAY → F•5 IP STREAM SELECT: STREAM1 / STREAM2 / STREAM3 / STREAM4

16. STATUS DISPLAY

16.8.11 Displaying and Configuring the SFP Information screen

To display SFP information screen, follow the procedure below.
The information about the installed SFP module will be displayed.

Procedure

STATUS	→	F•2	SDI / IP ANALYSIS	→	F•4	IP	→	F•5	next menu	→	F•1	SFP
--------	---	-----	-------------------	---	-----	----	---	-----	-----------	---	-----	-----



The screenshot shows the SFP Information screen with the following details:

	Port 1	Port 2
Identifier	SFP+	SFP+
Connector	LC	LC
Transceiver	10G Base-SR	10G Base-SR
Encoding	64B/66B	64B/66B
BR.Nominal	10.3 Gbit/s	10.3 Gbit/s
Vendor Name / Vendor OUI	AVAGO / 00-17-6a	AVAGO / 00-17-6a
Vendor PN / Vendor rev	AFBR-709SMZ / G4.1	AFBR-709SMZ / G4.1
Wavelength	850 nm	850 nm
Tx Power	-2.42 dBm (573.0 uW)	-2.54 dBm (557.8 uW)
Rx Power	-2.98 dBm (503.6 uW)	-40.00 dBm (0.1 uW)

Figure 16-23 SFP information screen

- Identifier
Displays the SFP transceiver module type.
- Connector
Displays the connector type.
- Transceiver
Displays the SFP transceiver module standard.
- Encoding
Displays the encode type.
- BR.Nominal
Displays the SFP transceiver module transmission rate.
- Vendor Name / Vendor OUI
Displays the SFP transceiver module vendor information.
- Vendor PN / Vendor rev
Displays the SFP transceiver module product name code and revision code.
- Wavelength
Displays the optical wavelength used by the SFP transceiver module.
- Tx Power
Displays the optical power output from the SFP transceiver module.
- Rx Power
Displays the optical power received by the SFP transceiver module.

16. STATUS DISPLAY

- Resetting the Ethernet port

To reset the Ethernet port, follow the procedure below.

Procedure

STATUS → F•2 SDI / IP ANALYSIS → F•4 IP → F•5 next menu → F•1 SFP → F•5 ETHER PORT RESET

16.8.12 Displaying the Packet Header Screen

To display the packet header screen, follow the procedure below.

Displays the header information of received packet's MAC, IP, UDP, RTP, and PAYLOAD.

Procedure

STATUS → F•2 SDI / IP ANALYSIS → F•4 IP → F•1 IP MEAS → F•5 next menu → F•2 PACKET HEADER

MODE = MAC/IP

1920x1080/59.94P YCbCr(422) 10bit 3G-A		IP A		TIME: 16:00:53		
MAC		IP				
Field	Data	Field	Data			
Destination Address(MAC)	01:00:5e:04:01:01	Version	0x4			
Source Address(MAC)	00:0f:9b:03:7d:f0	IHL	20 byte			
Type	IPv4	Type of Service	0xc8			
		Tortal Length	1248 byte			
		Identification	0x04E0			
		Flags	0x02			
		Flagment offset	0x0			
		Time to Live	64			
		Protocol	UDP			
		Header Checksum	0x6f93			
		Source Address	192.168.21.4			
		Destination Address	239.4.1.1			
F1	F2	F3	F4	F5	F6	F7
MODE	MEASURE				INPUT SELECT	up menu
MAC/IP	RUN				A	

MODE = UDP/RTP

1920x1080/59.94P YCbCr(422) 10bit 3G-A		IP A		TIME: 16:01:22		
UDP		RTP				
Field	Data	Field	Data			
Source Port	5004	Version	2			
Destination Port	5004	Padding	false			
Length	1228	Extension	false			
Checksum	0x0000	CSRC	0			
		Marker	false			
		Payload type	96			
		Sequence number	39437			
		Timestamp	783123593			
		SSRC	690881400			
F1	F2	F3	F4	F5	F6	F7
MODE	MEASURE				INPUT SELECT	up menu
UDP/RTP	RUN				A	

16. STATUS DISPLAY

MODE = PAYLOAD

1920x1080/59.94P YCbCr(422) 10bit 3G-A IP A TIME: 16:01:42

Payload Header (SMPTE2110-20)

Field	Data
Extension Sequence Number	33472
SRD Length	1200
Field Identification	0
SRD Row Number	1079
Continuation	0
SRD Offset	1440

F1 MODE F2 MEASURE F3 F4 F5 F6 INPUT SELECT F7 up menu
PAYLOAD RUN A menu

Figure 16-24 Packet header screen

- MAC

Displays the destination address, source address, and the higher level protocol type of the MAC layer in the header information of the MAC frame.

- IP

Displays the version, header length, service type, total length, ID number, flag, fragment offset, packet lifetime, protocol, IP header checksum, source IP address, and destination IP address in the IP header information.

- UDP

Displays the source port number, destination port number, packet length, and checksum in the UDP header information.

- RTP

Displays the version, padding, extended header availability, CSRC, marker bit, payload type, sequence number, timestamp, and SSRC ID in the RTP header information.

- PAYLOAD

Displays the extended sequence number, data length, field ID, data number, continue bit, and offset in the PAYLOAD header information.

16. STATUS DISPLAY

16.8.13 Configuring the Packet Header Screen

- Selecting the Display Mode

To select the display mode, follow the procedure below.

Procedure

STATUS → F•2 SDI / IP ANALYSIS → F•4 IP → F•1 IP MEAS → F•5 next menu → F•2
PACKET HEADER → F•1 MODE: MAC/IP / UDP/RTP / PAYLOAD

- Selecting the Measurement Mode

To select the measurement mode, follow the procedure below.

Procedure

STATUS → F•2 SDI / IP ANALYSIS → F•4 IP → F•1 IP MEAS → F•5 next menu → F•2
PACKET HEADER → F•2 MEASURE: RUN / STOP

Settings

RUN:	The input signal is automatically updated and displayed.
STOP:	The input signal is displayed statically.

16. STATUS DISPLAY

16.8.14 Displaying the Buffer Screen (SER06)

To display the Buffer screen, follow the procedure below. The measured values of CINST, VRX, or FPT are displayed when the transmission type of SMPTE ST2110-21 is Narrow, Narrow Linear, or Wide. CMAX indicates the value when the packets being sent are full. VRX indicates the value of the virtual receive buffer.

Cinst displays the number of packets stored from the interval between packets in the network compatibility model based on SMPTE ST2110-21.

The transmitter must send the packet so that it does not exceed the CMAX specified in SMPTE ST 2110-21.

VRX displays the packet receive buffer in the virtual receive buffer model based on SMPTE ST 2110-21.

The virtual receive buffer must not exceed the VRX full specified in SMPTE ST 2110-21. (except when measuring JPEG XS)

FPT displays the time from the beginning of the frame to the first packet based on the SMPTE Epoch.

The CINST, VRX, or FPT values for both of port 1 and 2 are displayed.

If Type is set to ST2110 on the IP SETUP1 tab in the SYS menu, you can select.

Procedure

STATUS → F•2 SDI / IP ANALYSIS → F•4 IP → F•1 IP MEAS → F•5 next menu → F•3 BUFFER/FPT

MODE = CINST



16. STATUS DISPLAY

MODE = VRX

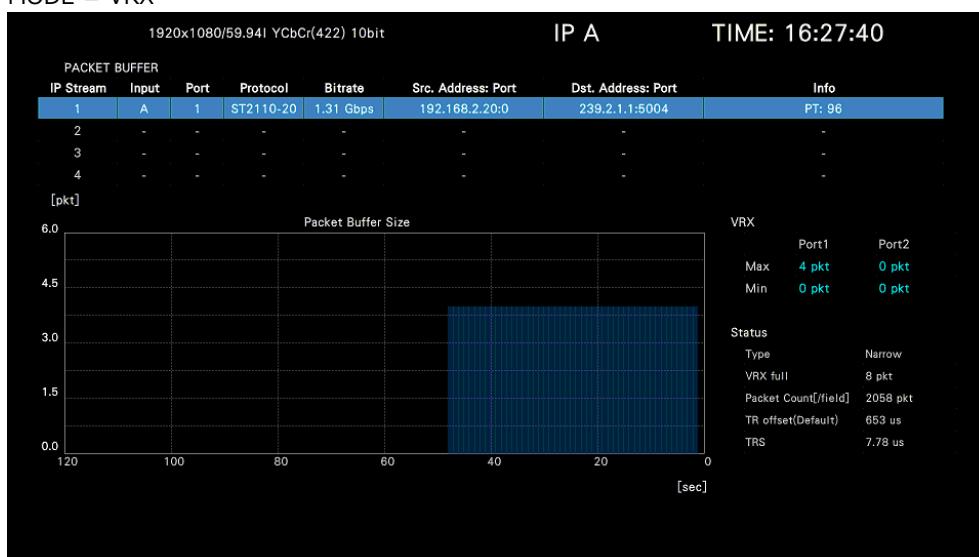

MODE = FPT



Figure 16-25 Buffer screen

- Cinst: Displays the maximum / minimum value of the number of packets stored instantaneously per second.
- Type: Displays the packet transmission type of SMPTE ST 2110-21. (Displays the type set in Sender Type of IP SETUP2.)
- CMAX: Displays the maximum number of packets specified by SMPTE ST 2110-21.
- Packet Count: Displays the number of packets per field or frame.
- Tdrain: Displays the time interval at which packets are output in the network compatibility model.
- VRX: Displays the maximum / minimum value of the number of packets in the virtual receive buffer per second.
- VRX full: Displays the maximum value of the virtual receive buffer specified by SMPTE ST 2110-21.
- TR Offset: Displays the offset at which the first packet of the frame is read from the reference time of the frame. (Displays the type set in TR Offset of IP SETUP2.)

16. STATUS DISPLAY

- TRS: Displays the read interval from the virtual receive buffer.
- FPT: Displays the time from the frame reference time to the first packet of the frame.

16.8.15 Configuring the Buffer Screen (SER06)

- Selecting the Display Mode

To select the display mode, follow the procedure below.

Procedure

STATUS → F.2 SDI / IP ANALYSIS → F.4 IP → F.1 IP MEAS → F.5 next menu → F.3
BUFFER/FPT → F.1 MODE: CINST / VRX / FPT

- Clearing the Chart

To clear the chart and measurement values, follow the procedure below.

Procedure

STATUS → F.2 SDI / IP ANALYSIS → F.4 IP → F.1 IP MEAS → F.5 next menu → F.3
BUFFER/FPT → F.2 CHART CLEAR

- Setting the Chart

To display the chart setup menu, follow the procedure below.

[See also] 16.8.21, "Configuring the Chart Setup Menu."

Procedure

STATUS → F.2 SDI / IP ANALYSIS → F.4 IP → F.1 IP MEAS → F.5 next menu → F.3
BUFFER/FPT → F.4 CHART SETUP

- Selecting the IP Stream

To select the IP stream you will measure, follow the procedure below.

Procedure

STATUS → F.2 SDI / IP ANALYSIS → F.4 IP → F.1 IP MEAS → F.5 next menu → F.3
BUFFER/FPT → F.5 IP STREAM SELECT: STREAM1 / STREAM2 / STREAM3 / STREAM4

16. STATUS DISPLAY

16.8.16 Displaying the NMOS Screen

To display the NMOS screen, follow the procedure below.

The NMOS display has the NMOS CONNECTION LIST (IS-05) screen and the NMOS REGISTRATION LIST (IS-04) screen.

Procedure

STATUS → F•2 SDI / IP ANALYSIS → F•4 IP → F•1 IP MEAS → F•5 next menu → F•3 NMOS

- NMOS CONNECTION LIST (IS-05) screen

The NMOS CONNECTION LIST (IS-05) screen is displayed the requests received from the NMOS for each receiver (*1).

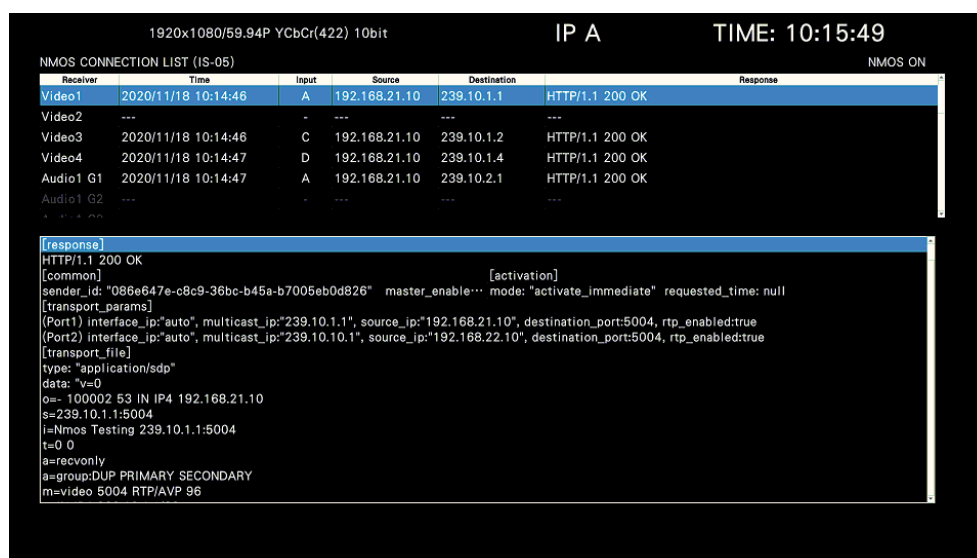

Figure 16-26 NMOS CONNECTION LIST (IS-05) screen

The upper half of the screen is displayed a list of some of the requests that each receiver (*1) received from the NMOS.

Receivers (*1) that are not enabled with the current instrument settings are displayed in gray text.

Receivers (*1) that have not received a request after booting are displayed as "---".

- Receiver: Video Stream1 is displayed as "Video1" and Audio Stream1 G1 is displayed as "Audio1". (*2)
- Time: The last time of the request received from the NMOS is displayed.
- Input: If set in Display Assignment, the corresponding input channel is displayed.
- Source: The source_ip of the request received from the NMOS is displayed.
- Destination: The multicast_ip of the request received from the NMOS is displayed.
- Info: The return status returned by the instrument is displayed for the received request.

16. STATUS DISPLAY

The lower half of the screen is displayed the requests received by the receiver (*1) selected on the upper half of the screen.

As with the upper of the screen, receivers (*1) that are not enabled with the current instrument settings are displayed in gray text, and receivers (*1) that have not received a request after booting are displayed as "---" for each item.

- *1 When the SER32 IP TSG option is enabled, the sender is also displayed.
- *2 When the SER32 IP TSG option is enabled, the sender Video is displayed as TSG Video and the sender Audio is displayed as TSG Audio.

- **NMOS REGISTRATION LIST (IS-04) screen**

The NMOS REGISTRATION LIST (IS-04) screen is displayed the hosts that are presenting the registry (RDS) service that the instrument could recognize.

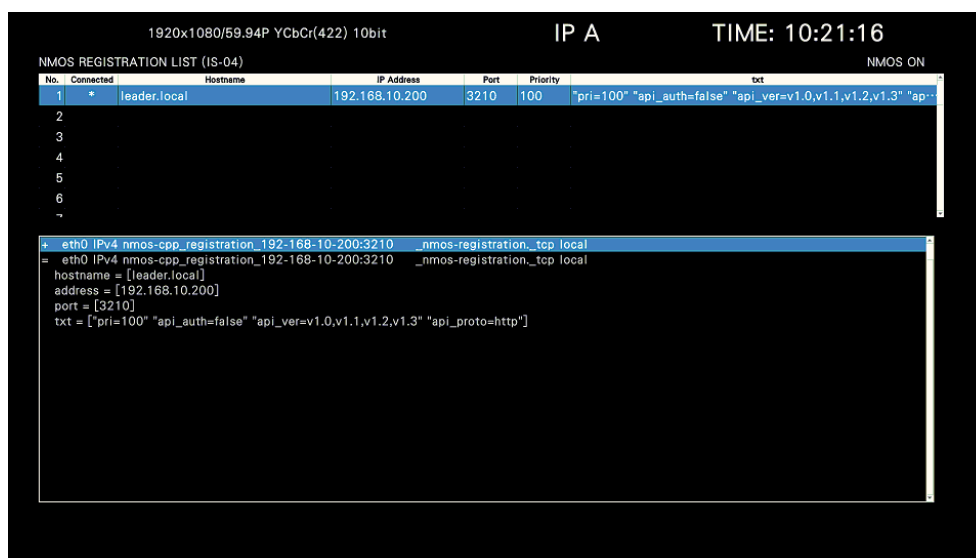

Figure 16-27 NMOS REGISTRATION LIST (IS-04) screen

The upper half of the screen is enumerated the excerpts of the RDS server informations that could be recognized by this instrument on the network.

- No.: This is enumerated in the order in which the RDS server was able to recognize.
- Connected: "*" Is displayed when the instrument is a host communicating as an NMOS registry server.
- Hostname: The host name is displayed.
- IP Address: The host IP address is displayed.
- Port: The registry service port number is displayed.
- Priority: The registry service priority is displayed.
- txt: The TXT record is displayed.

The lower half of the screen is displayed the progress up to RDS detection.

There are three types of NMOS REGISTRATION LIST (IS-04) screen displays: Multicast, Unicast, and Manual. Select from DNS-SD on the NMOS tab of the SYS menu.

When set to Manual, nothing is displayed at the lower half of the screen.

16. STATUS DISPLAY

- Multicast

List all RDS servers that the instrument has detected.

"*" Is displayed in "Connected" for the RDS server that has registered the node of the instrument.

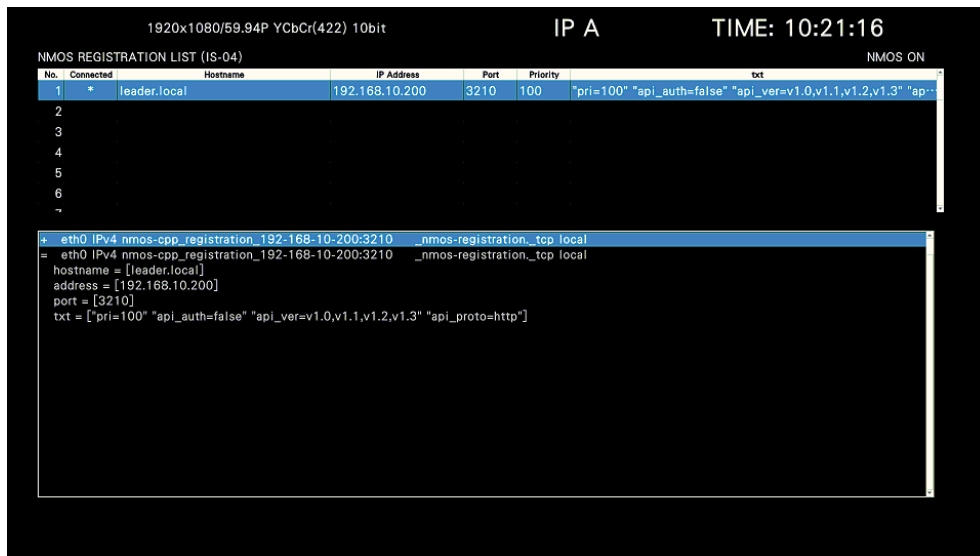

Figure 16-28 Multicast screen

- Unicast

List all RDS servers that the instrument has detected.

"*", "0" and "[Unicast]" are displayed in "Connected", "Priority" and "txt" at the upper half of the screen, respectively.



Figure 16-29 Unicast screen

16. STATUS DISPLAY

- Manual

The IP Address and port number set on the NMOS tab of the SYS menu are displayed. "*", "MANUAL", "0" and "[Manual]" are displayed in "Connected", "Hostname", "Priority" and "txt" at the upper half of the screen, respectively.



The screenshot displays a terminal window with the following information:

- Resolution: 1920x1080/59.94i YCbCr(422) 10bit
- IP Address: IP A
- Time: TIME: 14:48:14
- Table Title: NMOS REGISTRATION LIST (IS-04)
- Table Columns: No., Connected, Hostname, IP Address, Port, Priority, txt
- Table Content:

No.	Connected	Hostname	IP Address	Port	Priority	txt
1	*	MANUAL	192.168.10.80	8080	0	[Manual]
2						
3						
4						
5						
6						
~						

Figure 16-30 Manual screen

16.8.17 Configuring the NMOS Screen

- Selecting the list

You can switch between the NMOS CONNECTION LIST (IS-05) screen and the NMOS REGISTRATION LIST (IS-05) screen, follow the procedure below.

Procedure

STATUS → F•2 SDI / IP ANALYSIS → F•4 IP → F•1 IP MEAS → F•5 next menu → F•3
 NMOS → F•1 MODE: CONNECTION / REGISTRATION

Settings

CONNECTION: The NMOS CONNECTION LIST (IS-05) screen is displayed.

REGISTRATION: The NMOS REGISTRATION LIST (IS-04) screen is displayed.

- Switching the function dial (F•D) operation

To switch the function dial (F•D) operation, follow the procedure below.

Procedure

STATUS → F•2 SDI / IP ANALYSIS → F•4 IP → F•1 IP MEAS → F•5 next menu → F•3
 NMOS
 → F•2 SCROLL LIST: RCV LIST / DATA LIST
 → F•2 SCROLL LIST: RDS LIST / DATA LIST

Settings (NMOS CONNECTION LIST (IS-05) screen)

RCV LIST: The cursor on the upper half of the screen can be operated with the function dial (F•D) and V POS knob. Press the function dial (F•D) and the V POS knob to return to the starting position.

DATA LIST: The cursor on the lower half of the screen can be operated with the function dial (F•D) and H POS knob. Press the function dial (F•D) and the H POS knob to return to the starting position.

Settings (NMOS REGISTRATION LIST (IS-04) screen)

RDS LIST: The cursor on the upper half of the screen can be operated with the function dial (F•D) and V POS knob. Press the function dial (F•D) and the V POS knob to return to the starting position.

DATA LIST: The cursor on the lower half of the screen can be operated with the function dial (F•D) and H POS knob. Press the function dial (F•D) and the H POS knob to return to the starting position.

16. STATUS DISPLAY

- Saving data to a USB memory device

To save the information displayed on the screen as a text file to the USB memory, follow the procedure below.

This menu appears when a USB memory device is connected.

Procedure

STATUS → F•2 SDI / IP ANALYSIS → F•4 IP → F•1 IP MEAS → F•5 next menu → F•3
NMOS → F•4 LOG STORE

- USB Memory Device Folder Structure

The text file is saved in the LOG folder.

📁 USB memory device

└ 📁 LV5600_USER or LV7600_USER

└ 📁 LOG

└ 📄 NMOS_CONNECTION_LIST_YYYYMMDDhhmmss.txt

└ 📄 NMOS_REGISTRATION_LIST_YYYYMMDDhhmmss.txt

16. STATUS DISPLAY

16.8.18 Displaying and Configuring the JPEG XS Status Screen (SER33)

When measuring JPEG XS, to display JPEG XS status screen, follow the procedure below. Display the status obtained from the JPEG XS packet.

Procedure

STATUS → F•2 SDI / IP ANALYSIS → F•4 IP → F•1 IP MEAS → F•5 next menu → F•5 next menu → F•1 JPEG XS STATUS

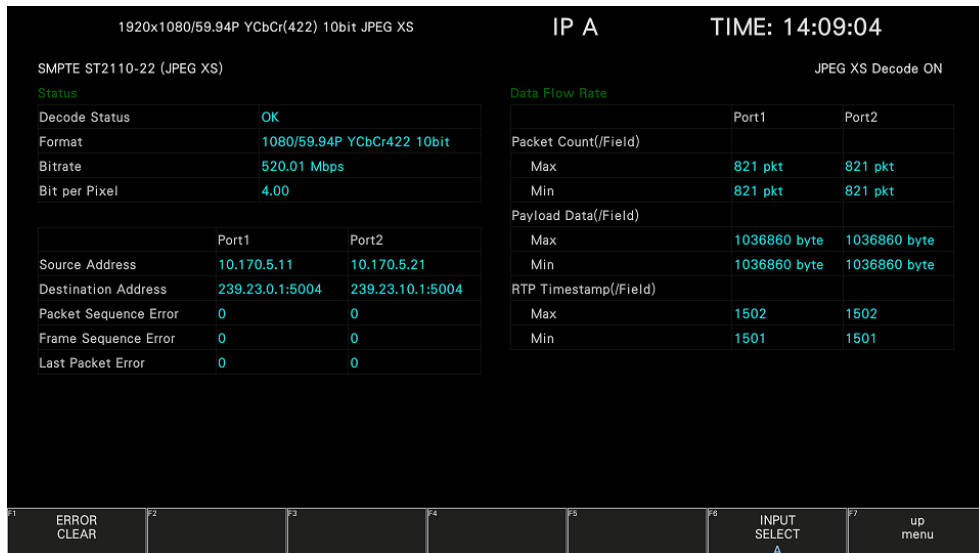

Figure 16-31 JPEG XS status screen

- Decode Status

Displays the decode status as one of the following. OK is displayed in cyan, and error is displayed in red.

OK:	No error detection
Unsupported format error:	Format error
Image size error:	Image size error
CAP marker error:	Function marker detection error
PIH marker error:	Picture header marker detection error
CDT marker error:	Component table marker detection error
WGT marker error:	Weight marker detection error
SLH marker error:	Slice marker detection error
Precinct length error:	Precinct length error (When the Lprc written in the precinct header does not match the actual precinct length)
Codestream length error:	Codestream length error (When the Lcod written in the image header does not match the actual codestream length)
Codestream last error:	Codestream last error (When the cs_last signal does not match the Lcod written in the picture header)
Unknown error:	Unknown error

16. STATUS DISPLAY

- Format
Display the input format.
- Bitrate
Display bitrate.
- Bit per Pixel
Displays the number of bits per pixel.
- Source Address
Displays the source IP address.
- Destination Address
Displays the destination IP address and port number.
- Packet Sequence Error
Counts the number of missing packets.
Any missing packets will be displayed in red and can be cleared to 0 by pressing **F•1** ERROR CLEAR.
- Frame Sequence Error
Counts the number of missing frames.
Any missing frames will be displayed in red and can be cleared to 0 by pressing **F•1** ERROR CLEAR.
- Last Packet Error
Count mismatches between last packet and marker bits.
Any mismatches will be displayed in red and can be cleared to 0 by pressing **F•1** ERROR CLEAR.
- Pcket Count(/Field)
Displays the maximum and minimum number of packets per field or frame.
- Payload Data(/Field)
Displays the maximum and minimum payload data amount per field or frame.
If it differs from the theoretical value or if the maximum and minimum values are different, it will be displayed in yellow.
- RTP Timestamp(/Field)
Displays the maximum and minimum RTP timestamp per field or frame.

16. STATUS DISPLAY

16.8.19 Displaying and Configuring the JPEG XS Header Screen (SER33)

When measuring JPEG XS, to display JPEG XS header screen, follow the procedure below. Analyze and display the headers of JPEG XS packets.

The JPEG XS header screen shows the payload header on the left half and the box on the right half. The box can be switched with **F•1** MODE.

(VIDEO SUPPORT / PROFILE / BUFFER / METADATA / TRANSPORT / IMAGE / COLOR)

Items without information are displayed as "---". Also, if the detected content is not compatible with LV5600/7600, it will be displayed in red.

Procedure

STATUS → **F•2** SDI / IP ANALYSIS → **F•4** IP → **F•1** IP MEAS → **F•5** next menu → **F•5** next menu → **F•2** JPEG XS HEADER

MODE = VIDEO SUPPORT

1920x1080/59.94P YCbCr(422) 10bit JPEG XS		IP A	TIME: 14:09:56			
SMPTE ST2110-22 (JPEG XS) PACKET HEADER ANALYSIS (Port1)		JPEG XS Decode ON				
Payload Header		Video Support Box				
Transmission Mode(T)	Sequential	Box Length(LBox)	42			
Packetization Mode(K)	Codestream Packetization	Box Type(TBox)	jpvs			
Last Packet(L)	TRUE	Video Information Box				
Interlaced(I)	Progressive	Box Length(LBox)	22			
Frame Counter	10	Box Type(TBox)	jpvi			
Slice Counter	0	Bit Rate(brat)	530			
Packet Counter	0	Frame Rate(frat)	0x0200003c			
		Framerate_Numerator	60			
		Framerate_Denominator	2 (1.001)			
		Interlaced(I)	0 (Progressive)			
		Sample Characteristics(schar)	0x8090			
		Valid	1			
		Bit Depth	9 (10 bit)			
		Sample Struct	0 (4:2:2(YCbCr))			
		Timecode(tcod)	0x00000000			
F1 MODE	F2	F3 PORT	F4	F5	F6 INPUT SELECT	F7 up menu
VIDEO SUPPORT		PORT1			A	

Figure 16-32 JPEG XS header screen (VIDEO SUPPORT)

16. STATUS DISPLAY

- Payload Header

This item is displayed in common regardless of the **F•1** MODE.

Transmission Mode(T):	Transmission mode
Packetization Mode(K):	Packetization mode
Last Packet(L):	Last packet of frame
Interlaced(I):	Frame scan
Frame Counter:	Frame number
Slice Counter:	Slice number
Packet Counter:	Packet number

- Video Support Box

Box Length(LBox):	Box length
Box Type(TBox):	Box type

- Video Information Box

Box Length(LBox):	Box length
Box Type(TBox):	Box type
Bit Rate(brat):	Bit rate
Frame Rate(frat):	Frame rate
Framerate_Numerator:	Frame rate numerator
Framerate_Denominator:	frame rate denominator
Interlaced(I):	Interlace flag
Sample Characteristics(schar):	Sample characteristics
Valid:	Schar valid flag
Bit Depth:	Bit depth
Sample Struct:	Sample structure
Timecode(tcod):	Time code

16. STATUS DISPLAY

MODE = PROFILE

1920x1080/59.94P YCbCr(422) 10bit JPEG XS		IP A	TIME: 14:10:10
SMPTE ST2110-22 (JPEG XS) PACKET HEADER ANALYSIS (Port1)		JPEG XS Decode ON	
Payload Header		Profile and Level Box	
Transmission Mode(T)	Sequential	Box Length(LBox)	12
Packetization Mode(K)	Codestream Packetization	Box Type(TBox)	jxpl
Last Packet(L)	TRUE	Box Data(DBox)	0x4a401006
Interlaced(I)	Progressive	Codestream Profile	0x4a40 (High 444.12)
Frame Counter	5	Codestream Level	0x1006
Slice Counter	0	Level Signaling	0x10 (2k-1)
Packet Counter	0	Sublevel Signaling	0x06 (Sublev4bpp)
F1	MODE	F2	
	PROFILE	F3	PORT
			PORT1
		F4	
		F5	
		F6	INPUT
			SELECT
		F7	A
			up
			menu

Figure 16-33 JPEG XS header screen (PROFILE)

- Profile and Level Box

Box Length(LBox):	Box length
Box Type(TBox):	Box type
Box Data(DBox):	Box data
Codestream Profile:	Codestream profile
Codestream Level:	Codestream level
Level Signaling:	Level signaling
Sublevel Signaling:	Sublevel signaling

16. STATUS DISPLAY

MODE = BUFFER

1920x1080/59.94P YCbCr(422) 10bit JPEG XS IP A TIME: 14:10:18

SMPTE ST2110-22 (JPEG XS) PACKET HEADER ANALYSIS (Port1) JPEG XS Decode ON

Payload Header

Transmission Mode(T)	Sequential
Packetization Mode(K)	Codestream Packetization
Last Packet(L)	TRUE
Interlaced(I)	Progressive
Frame Counter	0
Slice Counter	0
Packet Counter	0

Buffer Model Description Box(option)

Box Length(LBox)	---
Box Type(TBox)	---
Box Data(DBox)	---
Buffer Model Type	---
Horizontal Blanking Periods	---
Vertical Blanking Periods	---

F1 MODE F2 F3 PORT F4 F5 F6 INPUT F7 up
BUFFER PORT1 SELECT menu
A

Figure 16-34 JPEG XS header screen (BUFFER)

- Buffer Model Description Box(option)

Box Length(LBox):	Box length
Box Type(TBox):	Box type
Box Data(DBox):	Box data
Buffer Model Type:	Buffer model type
Horizontal Blanking Periods:	Horizontal blanking periods
Vertical Blanking Periods:	Vertical blanking periods

16. STATUS DISPLAY

MODE = METADATA

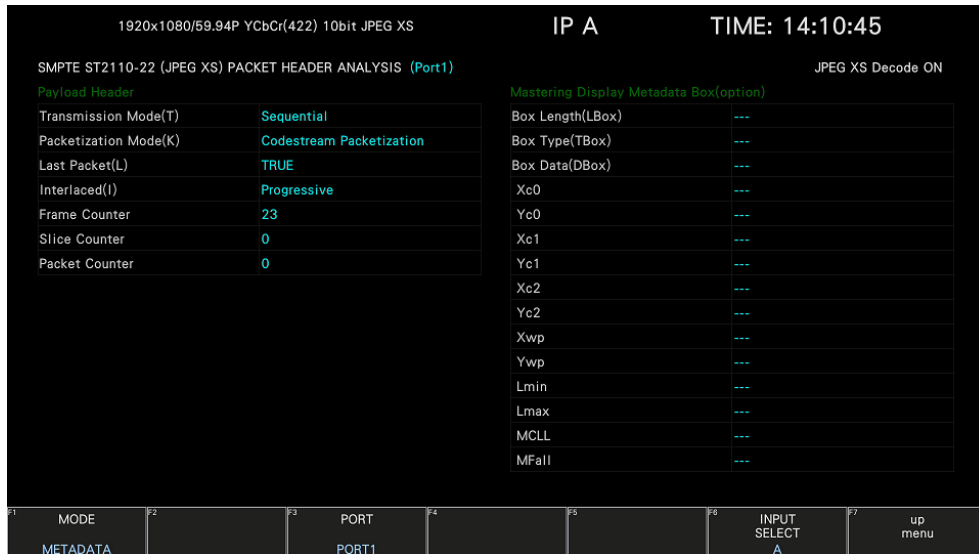

Figure 16-35 JPEG XS header screen (METADATA)

- Mastering Display Metadata Box(option)

Box Length(LBox):	Box length
Box Type(TBox):	Box type
Box Data(DBox):	Box data
Xc0:	XY information parameters
Yc0:	XY information parameters
Xc1:	XY information parameters
Yc1:	XY information parameters
Xc2:	XY information parameters
Yc2:	XY information parameters
Xwp:	XY information parameters
Ywp:	XY information parameters
Lmin:	Minimum luminance
Lmax:	Maximum luminance
MCLL:	MAX CLL
MFall:	MAX FALL

16. STATUS DISPLAY

MODE = TRANSPORT

1920x1080/59.94P YCbCr(422) 10bit JPEG XS		IP A	TIME: 14:10:58
SMPTE ST2110-22 (JPEG XS) PACKET HEADER ANALYSIS (Port1)		JPEG XS Decode ON	
Payload Header		JPEG XS Video Transport Parameter Box(option)	
Transmission Mode(T)	Sequential	Box Length(LBox)	---
Packetization Mode(K)	Codestream Packetization	Box Type(TBox)	---
Last Packet(L)	TRUE	Box Data(DBox)	---
Interlaced(I)	Progressive	Slgs	---
Frame Counter	21	Rsync	---
Slice Counter	0	Tseq	---
Packet Counter	0	MTU	---
F1	MODE	F2	
	TRANSPORT	F3	PORT
			PORT1
		F4	
		F5	
		F6	INPUT
			SELECT
		F7	A
			up
			menu

Figure 16-36 JPEG XS header screen (TRANSPORT)

- JPEG XS Video Transport Parameter Box(option)

Box Length(LBox):	Box length
Box Type(TBox):	Box type
Box Data(DBox):	Box data
Slgs:	Slice information
Rsync:	Parallel processing information
Tseq:	Buffer size information
MTU:	0 fixed

16. STATUS DISPLAY

MODE = IMAGE

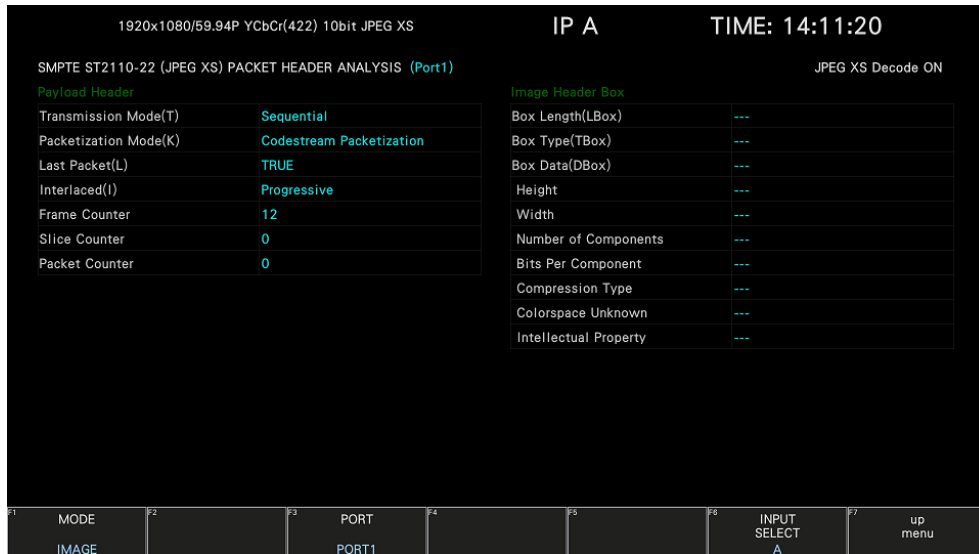

Figure 16-37 JPEG XS header screen (IMAGE)

- Image Header Box

Box Length(LBox):	Box length
Box Type(TBox):	Box type
Box Data(DBox):	Box data
Height:	Vertical size
Width:	Horizontal size
Number of Components:	Number of components
Bits Per Component:	Bits per component
Compression Type:	Compression type (12 for JPEG XS)
Colorspace Unknown:	Presence or absence of color space information
Intellectual Property:	Intellectual property rights information

16. STATUS DISPLAY

MODE = COLOR

1920x1080/59.94P YCbCr(422) 10bit JPEG XS		IP A	TIME: 14:11:34
SMPTE ST2110-22 (JPEG XS) PACKET HEADER ANALYSIS (Port1)		JPEG XS Decode ON	
Payload Header		Color Specification Box	
Transmission Mode(T)	Sequential	Box Length(LBox)	18
Packetization Mode(K)	Codestream Packetization	Box Type(TBox)	color
Last Packet(L)	TRUE	Box Data(DBox)	0x05000000010001000100
Interlaced(I)	Progressive	Method (must be 5)	5
Frame Counter	11	Precedence (must be 0)	0
Slice Counter	0	Approximation (must be 0)	0
Packet Counter	0	Color Primaries	1
		Transfer Characteristics	1 (ITU-R BT.709)
		Matrix Coefficients	1
		Video Full Range	0
		Reserved	0
F1	MODE	F2	
	COLOR	F3	PORT
			PORT1
		F4	
		F5	
		F6	INPUT
			SELECT
			A
		F7	up
			menu

Figure 16-38 JPEG XS header screen (COLOR)

- Color Specification Box

Box Length(LBox):	Box length
Box Type(TBox):	Box type
Box Data(DBox):	Box data
Method (must be 5):	Method to specify color space (must be 5)
Precedence (must be 0):	Precedence (must be 0)
Approximation (must be 0):	Color space approximation (must be 0)
Color Primaries:	Color primaries
Transfer Characteristics:	Transfer characteristics
Matrix Coefficients:	Matrix coefficients
Video Full Range:	Video full range flag
Reserved:	Reserved

16. STATUS DISPLAY

16.8.20 Displaying the Format Comparison Screen (SER33)

When measuring JPEG XS, to display format comparison screen, follow the procedure below. On the format comparison screen, the formats detected by auto (detected by the LV5600/7600), SDP, ST2110-40 (Payload ID), and ST2110-22 (JPEG XS) are compared and displayed in yellow if different. Items without information are displayed as "---" and are not compared. Also, if the detected content is not compatible with LV5600/7600, it will be displayed in red.

Procedure

STATUS → F•2 SDI / IP ANALYSIS → F•4 IP → F•1 IP MEAS → F•5 next menu → F•5 next menu → F•3 FORMAT COMPARISON

1920x1080/59.94P YCbCr(422) 10bit JPEG XS		IP A		TIME: 14:15:15	
VIDEO FORMAT COMPARISON			JPEG XS Decode ON		
	Detected	SDP	ST2110-40 (Payload ID)	ST2110-22 (JPEG XS)	
Image	1920x1080	1920x1080	1920x1080	---	
Frame/Field Rate	59.94	59.94	59.94	59.94	
I/P/PsF	Progressive	Progressive	Progressive	Progressive	
SamplingStructure	---	4:2:2	4:2:2	4:2:2	
Color	---	YCbCr	YCbCr	YCbCr	
BitDepth	---	10	10	10	
HDR/SDR	---	SDR	SDR	---	
Colorimetry	---	BT.709	BT.709	BT.709	

Figure 16-39 Format comparison screen

16. STATUS DISPLAY

16.8.21 Configuring the Chart Setup Menu

To display the chart setup menu, follow the procedure below.

Procedure (IP Status)

STATUS	→	F•2	SDI / IP ANALYSIS	→	F•4	IP	→	F•4	CHART SETUP
--------	---	-----	-------------------	---	-----	----	---	-----	-------------

Procedure (Packet Jitter)

STATUS	→	F•2	SDI / IP ANALYSIS	→	F•4	IP	→	F•1	IP MEAS	→	F•1	PACKET JITTER	→	F•4	CHART SETUP
--------	---	-----	-------------------	---	-----	----	---	-----	---------	---	-----	---------------	---	-----	-------------

Procedure (PTP)

STATUS	→	F•2	SDI / IP ANALYSIS	→	F•4	IP	→	F•1	IP MEAS	→	F•2	PTP	→	F•4	CHART SETUP
--------	---	-----	-------------------	---	-----	----	---	-----	---------	---	-----	-----	---	-----	-------------

Procedure (PTP Timing Comparison)

STATUS	→	F•2	SDI / IP ANALYSIS	→	F•4	IP	→	F•1	IP MEAS	→	F•3	TIMING	COMPARISON	→	F•4	CHART SETUP
--------	---	-----	-------------------	---	-----	----	---	-----	---------	---	-----	--------	------------	---	-----	-------------

Procedure (Path Delay)

STATUS	→	F•2	SDI / IP ANALYSIS	→	F•4	IP	→	F•1	IP MEAS	→	F•4	PATH DELAY	→	F•4	CHART SETUP
--------	---	-----	-------------------	---	-----	----	---	-----	---------	---	-----	------------	---	-----	-------------

Procedure (Buffer)

STATUS	→	F•2	SDI / IP ANALYSIS	→	F•4	IP	→	F•1	IP MEAS	→	F•5	next menu	→	F•3	BUFFER/FPT	→	F•4	CHART SETUP
--------	---	-----	-------------------	---	-----	----	---	-----	---------	---	-----	-----------	---	-----	------------	---	-----	-------------

- Selecting the Measurement Time

To select the chart measurement time (horizontal axis) on the chart setup menu, follow the procedure below.

Procedure

F•1	PERIOD: 2MIN / 10MIN / 30MIN / 1HOUR / 2HOUR / 6HOUR / 12HOUR / 24HOUR / 72HOUR
-----	---

- Clearing the Chart

To clear the chart and measurement values on the chart setup menu, follow the procedure below.

Procedure

F•2	CHART CLEAR
-----	-------------

- Selecting the Port

To select the port you will measure on the chart setup menu, follow the procedure below. On the IP Status screen and Path Delay screen, you cannot select.

Procedure

F•3	PORT SELECT: PORT1 / PORT2 / <u>BOTH</u>
-----	--

16. STATUS DISPLAY

- Saving the chart

To save the chart in a USB memory as a csv format on the Chart setting menu, follow the procedure below.

This menu appears when a USB memory device is connected to the instrument.

The data that can be acquired are the values of MAX, MIN, and AVG.

The time of the log data is the time when CHART CLEAR was executed. If PTP is selected at Time on the CAPTURE & DISPLAY tab in the SYS menu, logging is executed at PTP time. (*1) Otherwise, it is executed in local time.

*1 Since it is not locked to PTP at startup, logging is executed in local time.

Procedure

F•4 CHART STORE

- USB Memory Device Folder Structure

The chart and measurement values are saved in the LOG folder.

📁 USB memory device

└─ 📁 LV5600_USER or LV7600_USER

 └─ 📁 LOG

 └─ 📄 xxxxx_YYYYMMDDhhmmss.csv

"xxxxx" is as shown below depending on the IP measurement screen.

IP measurement Screen	xxxxx	Description
IP Status	IP_STATUS_[PERIOD]	[PERIOD]: 2MIN / 10MIN / 30MIN / 1HOUR / 2HOUR / 6HOUR / 12HOUR / 24HOUR / 72HOUR
Packet Jitter	PACKET_JITTER_[PORT]_[STREAM]_[MODE]_[PERIOD]	[PORT]: PORT1 / PORT2 / BOTH [STREAM]: STREAM1 to 4 [MODE]: VIDEO ACTIVE / VIDEO ALL / AUDIO / ANC [PERIOD]: 2MIN / 10MIN / 30MIN / 1HOUR / 2HOUR / 6HOUR / 12HOUR / 24HOUR / 72HOUR
PTP Status	PTP_STATUS_[PORT]_[MODE]_[PERIOD]	[PORT]: PORT1 / PORT2 / BOTH [MODE]: DELAY TIME / TIME OFFSET [PERIOD]: 2MIN / 10MIN / 30MIN / 1HOUR / 2HOUR / 6HOUR / 12HOUR / 24HOUR / 72HOUR
PTP Timing Comparison	TIMING_COMPARISON_[PORT]_[STREAM]_[VIDEO]_[AUDIO]_[ANC]_[PERIOD]	[PORT]: PORT1 / PORT2 / BOTH [STREAM]: STREAM1 to 4 [VIDEO]: ON / OFF [AUDIO]: ON / OFF [ANC]: ON / OFF [PERIOD]: 2MIN / 10MIN / 30MIN / 1HOUR / 2HOUR / 6HOUR / 12HOUR / 24HOUR / 72HOUR
Path Delay	PATH_DELAY_[STREAM]_[PERIOD]	[STREAM]: STREAM1 to 4 [PERIOD]: 2MIN / 10MIN / 30MIN / 1HOUR / 2HOUR / 6HOUR / 12HOUR / 24HOUR / 72HOUR
Buffer	PACKET_BUFFER_[PORT]_[STREAM]_[MODE]_[PERIOD]	[PORT]: PORT1 / PORT2 / BOTH [STREAM]: STREAM1 to 4 [MODE]: CMAX / VRX [PERIOD]: 2MIN / 10MIN / 30MIN / 1HOUR / 2HOUR / 6HOUR / 12HOUR / 24HOUR / 72HOUR

16. STATUS DISPLAY

The output examples depending on the IP measurement screen are shown below. It is saved as a CSV format separated by commas (,).

IP Status

Time(UTC)	Bitrate(Port1)[bps]	Bitrate(Port2)[bps]
2020/6/2 9:32:46	2.61E+09	2.61E+09
2020/6/2 9:32:47	2.61E+09	2.61E+09
2020/6/2 9:32:48	2.61E+09	2.61E+09

Packet Jitter

Time(UTC)	Max(Port1)[us]	Min(Port1)[us]	Avg(Port1)[us]
2020/6/2 9:33:42	11.202	5.488	7.726
2020/6/2 9:33:43	11.264	5.468	7.726
2020/6/2 9:33:44	11.176	5.468	7.726

PTP Status

Time(UTC)	Max(Port1)[us]	Min(Port1)[us]	Current(Port1)[us]
2020/6/2 9:33:50	0.555	0.54	0.54
2020/6/2 9:33:51	0.546	0.539	0.542
2020/6/2 9:33:52	0.589	0.541	0.544

PTP Timing Comparison

Time(UTC)	Video Max(Port1)[us]	Video Min(Port1)[us]	Video Avg(Port1)[us]
2020/6/2 9:33:57	688	666	677
2020/6/2 9:33:58	688	666	677
2020/6/2 9:33:59	688	666	677

Path Delay

Time(UTC)	1st Port	Max[us]	Min[us]	Avg[us]
2020/6/2 9:34:05	Port1 1st	0	0	0
2020/6/2 9:34:06	Port1 1st	0.962	0.005	0.01
2020/6/2 9:34:07	Port1 1st	1.003	0.005	0.046

Buffer

Time(UTC)	(Port1)[pkt]
2020/6/2 9:34:12	2.994
2020/6/2 9:34:13	2.996
2020/6/2 9:34:14	2.996

- Selecting the IP Stream

To select the IP stream you will measure on the chart setup menu, follow the procedure below.

On the IP Status screen and PTP status screen, you cannot select.

Procedure

F•5	IP STREAM SELECT: <u>STREAM1</u> / STREAM2 / STREAM3 / STREAM4
-----	--

16.8.22 Configuring the Stream Setup Menu

To display the stream setup menu, follow the procedure below.

Procedure

STATUS	→	F•2	SDI / IP ANALYSIS	→	F•4	IP	→	F•5	IP STREAM SETUP
--------	---	-----	-------------------	---	-----	----	---	-----	-----------------

- Assigning IP Signals

To assign “Src. Address: Port” and “Dst. Address: Port” of the stream selected with the function dial (F•D) to the stream selected with **F•5** IP STREAM SELECT on the stream setup menu, follow the procedure below.

When you press **F•1** SET IP STREAM, Source Address, Destination Address, and Destination Port check boxes in the SYS menu are selected, and the values are set automatically.

[See also] 7.1.10, “Configuring the IP Signal Settings (SER05/SER06)”

Procedure

F•1	SET IP STREAM
-----	---------------

- Clearing the List

To clear the IP stream list on the stream setup menu, follow the procedure below.

Procedure

F•2	LIST CLEAR
-----	------------

- Setting the List Updating

To set the update mode of the IP stream list on the stream setup menu, follow the procedure below.

Procedure

F•3	LIST UPDATE MODE: <u>AUTO</u> / MANUAL / SEMI AUTO
-----	--

Settings

AUTO:	The IP stream list is updated automatically at fixed intervals.
MANUAL:	The IP stream list is not automatically updated.
SEMI AUTO:	The list is cleared when there are 32 streams in the IP stream list and a new stream is received.

- Selecting the IP Stream

To select the IP stream you will measure on the stream setup menu, follow the procedure below.

Procedure

F•5	IP STREAM SELECT: <u>STREAM1</u> / STREAM2 / STREAM3 / STREAM4
-----	--

16.9 Displaying a List of Ancillary Data

To display a list of ancillary data, follow the procedure below.
Ancillary data not embedded in every frame may not be displayed.

Procedure

STATUS → F•3 ANC DATA VIEWER

STANDARD	DID/SDID	STATUS	LINE No.	PACKET
S291M MARK DEL	80/--	MISSING		
S291M END PKT	84/--	MISSING		
S291M START PKT	88/--	MISSING		
ARIB B.27 CC	CF/--	MISSING		
S299M ctrl G4	E0/--	DETECT	571/F2	2/FRAME
S299M ctrl G3	E1/--	DETECT	571/F2	2/FRAME
S299M ctrl G2	E2/--	DETECT	571/F2	2/FRAME
S299M ctrl G1	E3/--	DETECT	571/F2	2/FRAME
S299M aud G4	E4/--	DETECT	1125/F2	1601/FRAME
S299M aud G3	E5/--	DETECT	1125/F2	1601/FRAME
S299M aud G2	E6/--	DETECT	1125/F2	1601/FRAME
S299M aud G1	E7/--	DETECT	1125/F2	1601/FRAME
S272M ctrl G4	EC/--	MISSING		
S272M ctrl G3	ED/--	MISSING		
S272M ctrl G2	EE/--	MISSING		
S272M ctrl G1	EF/--	MISSING		
RP165 EDH	F4/--	MISSING		
S272M ext G4	F8/--	MISSING		
S272M aud G4	F9/--	MISSING		
S272M ext G3	FA/--	MISSING		
S272M aud G3	FB/--	MISSING		
S272M ext G2	FC/--	MISSING		

Figure 16-40 Ancillary data screen

16.9.1 Ancillary Data Display Description

On the ancillary data screen, data is displayed as a list for each standard. If data is detected, "DETECT" is displayed in the STATUS column. If data is not detected, "MISSING" is displayed in the STATUS column.

- Data Viewing

By turning the function dial (F•D) to the right, you can scroll the screen to view all the data. You can also press **F•2** PAGE UP and **F•3** PAGE DOWN to move between pages. In the upper right of the screen, the "page number/total number of pages" is displayed. If you press the function dial (F•D), the cursor returns to the first data entry.

- Selecting the Displayed Stream

When the input signal is 3G-B, to set the display stream to STREAM1 or STREAM2, press **F•4** STREAM SELECT.

- Selecting the Content to Display

You can select the displayed content using **F•5** LINK when the input signal is multi link and **F•5** SUB when the input signal is 6G or 12G.

16. STATUS DISPLAY

16.9.2 Displaying a Dump of Ancillary Data

To display a dump of the data that you have selected on the ancillary data display, follow the procedure below.

By turning the function dial (F•D) to the right, you can scroll the screen to view all the data. If you press the function dial (F•D), the cursor returns to the first data entry.

Procedure

STATUS	→	F•3	ANC DATA VIEWER	→	F•1	ANC DUMP
--------	---	-----	-----------------	---	-----	----------

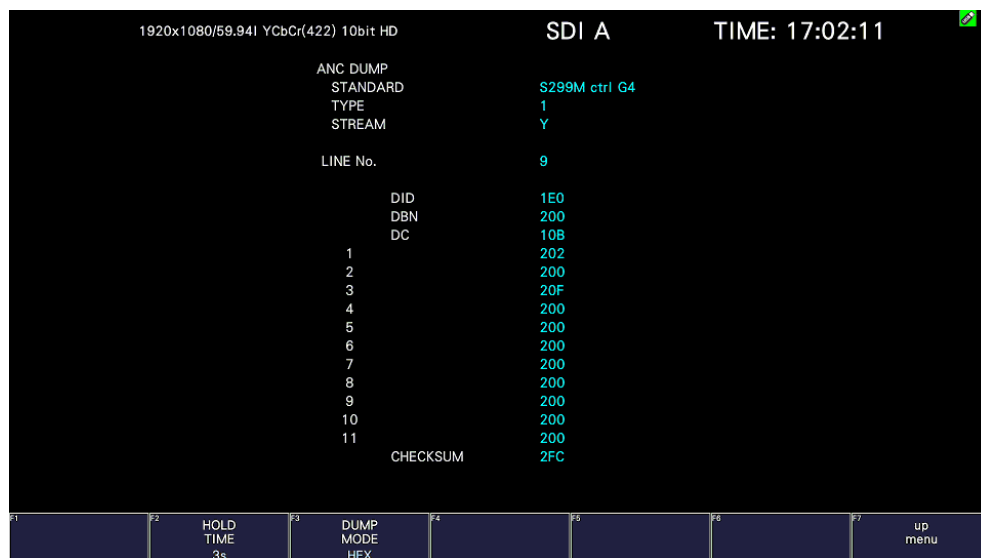

Figure 16-41 Ancillary dump screen

16.9.3 Updating the Dump Display

When the selected data is embedded in multiple lines, the line number that is displayed on the ANC dump screen is switched at a regular interval. (However, the order in which the line numbers are switched is irregular.)

To select the dump display update time, follow the procedure below.

Procedure

STATUS	→	F•3	ANC DATA VIEWER	→	F•1	ANC DUMP	→	F•2	HOLD TIME: HOLD / 1s / <u>3s</u>
--------	---	-----	-----------------	---	-----	----------	---	-----	----------------------------------

Settings

HOLD:	The screen is not updated.
1s:	The screen is updated once per second.
3s:	The screen is updated once every 3 seconds.

16. STATUS DISPLAY

16.9.4 Selecting the Dump Mode

To select the dump mode, follow the procedure below.

Procedure

STATUS	→	F•3	ANC DATA VIEWER	→	F•1	ANC DUMP	→	F•3	DUMP MODE: <u>HEX</u> / BINARY
--------	---	-----	-----------------	---	-----	----------	---	-----	--------------------------------

Settings

HEX:	Data is displayed in hexadecimal format.
BINARY:	Data is displayed in binary format.

DUMP MODE = HEX

1920x1080/59.94i YCbCr(422) 10bit HD		SDI A	TIME: 17:02:11
ANC DUMP		S299M ctrl G4	
STANDARD		1	
TYPE		Y	
STREAM		Y	
LINE No.		9	
	DID	1E0	
	DBN	200	
	DC	10B	
1		202	
2		200	
3		20F	
4		200	
5		200	
6		200	
7		200	
8		200	
9		200	
10		200	
11		200	
	CHECKSUM	2FC	
F1	F2	F3	F4
HOLD TIME 3s		DUMP MODE HEX	
F5	F6	F7	up menu

DUMP MODE = BINARY

1920x1080/59.94i YCbCr(422) 10bit HD		SDI A	TIME: 17:02:59
ANC DUMP		S299M ctrl G4	
STANDARD		1	
TYPE		Y	
STREAM		Y	
LINE No.		571	
	DID	0111100000	
	DBN	1000000000	
	DC	0100001011	
1		1000000010	
2		1000000000	
3		1000001111	
4		1000000000	
5		1000000000	
6		1000000000	
7		1000000000	
8		1000000000	
9		1000000000	
10		1000000000	
11		1000000000	
	CHECKSUM	1011111100	
F1	F2	F3	F4
HOLD TIME 3s		DUMP MODE BINARY	
F5	F6	F7	up menu

Figure 16-42 Selecting the dump mode

16.10 Detecting Ancillary Packets

To display the ancillary packet display, follow the procedure below.

If an ancillary packet is detected, "DETECT" appears. If not, "MISSING" appears. If a dummy packet is detected, "DUMMY" appears.

Procedure

STATUS → F•4 ANC PACKET



Figure 16-43 Ancillary packet screen

- Selecting the Content to Display

You can select the displayed content using F•5 LINK when the input signal is multi link and F•5 SUB when the input signal is 6G or 12G.

16.10.1 Ancillary Packet Screen Description

- AUDIO CONTROL PACKET

The embedded audio consists of 4 groups that each contain 4 channels. This makes for a total of 16 channels. A single audio control packet is embedded in each group.

[See also] 16.10.4, "Displaying Audio Control Packets"

- EDH (Error detection and handling; when the input signal is SD)

This packet is used for detecting transmission errors. When multiple devices are connected, this packet can be used to determine which device caused an error. Both full-field and active picture errors are detected.

[See also] 16.10.2, "Displaying EDH Packets"

- LTC (Linear/Longitudinal Time Code)

This is a type of timecode. One packet is embedded per frame.

- VITC (Vertical Interval Time Code)

This is a type of timecode. One packet is embedded per field.

16. STATUS DISPLAY

- PAYLOAD ID

This is a packet that is used to identify the video format. It conforms to SMPTE ST 352.
[See also] 16.10.3, "Displaying Payload IDs"

- EIA-708

This is one of the closed caption specifications. This packet is embedded in the V-ANC area.

This is used for digital video closed caption data. It only supports alphanumeric characters.

[See also] 16.10.11 "Displaying EIA-708 Data"

- EIA-608

This is one of the closed caption specifications. This packet is embedded in the V-ANC area.

This was previously used for analog composite (embedded in line number 21) closed caption data. It only supports alphanumeric characters.

[See also] 16.10.12 "Displaying EIA-608 Data"

- PROGRAM

It is embedded in the V-ANC area.

[See also] 16.10.13 "Displaying Program Data"

- DATA BROADCAST

It is embedded in the V-ANC area.

- VBI (when the input signal is SD)

It is embedded in the V-ANC area.

[See also] 16.10.14 "Displaying VBI Data"

- AFD

It is embedded in the V-ANC area.

[See also] 16.10.15 "Displaying AFD Packets"

- CLOSED CAPTION 1 to 3 (3G-B is not supported)

This is a closed caption information packet that is embedded in the V-ANC area. Up to three closed caption data entries can be embedded.

[See also] 16.10.6, "Displaying Closed Caption Packets"

- NET-Q (3G-B is not supported)

This is an inter-stationary control signal.

[See also] 16.10.7, "Displaying the Inter-Stationary Control Signal"

- TRIGGER PACKET (3G-B is not supported)

This is the data transmission trigger signal.

[See also] 16.10.8, "Displaying the Data Broadcast Trigger Signal"

- USER DATA 1 and 2 (3G-B is not supported)

Up to two packets of user-defined data.

[See also] 16.10.9, "Displaying User Data"

16. STATUS DISPLAY

16.10.2 Displaying EDH Packets

When the input signal is SD, to display the EDH packet screen, follow the procedure below.

Procedure

STATUS	→	F•4	ANC PACKET	→	F•1	PACKET ANALYSIS	→	F•1	EDH
--------	---	-----	------------	---	-----	-----------------	---	-----	-----

- Selecting the Display Format

You can use **F•1** DISPLAY to set the display format to TEXT (text display) or DUMP (dump display).

If you select DUMP, the dump display appears, and you can use the function dial (F•D) to view the entire data. If you press the function dial (F•D), the first data entry is displayed.

- Selecting the Dump Mode

When **F•1** DISPLAY is set to DUMP, you can use **F•2** DUMP MODE to set the dump mode to HEX (hexadecimal display) or BINARY (binary display).

16.10.3 Displaying Payload IDs

To show the payload ID display, follow the procedure below.

Procedure

STATUS	→	F•4	ANC PACKET	→	F•1	PACKET ANALYSIS	→	F•2	PAYLOAD ID
--------	---	-----	------------	---	-----	-----------------	---	-----	------------

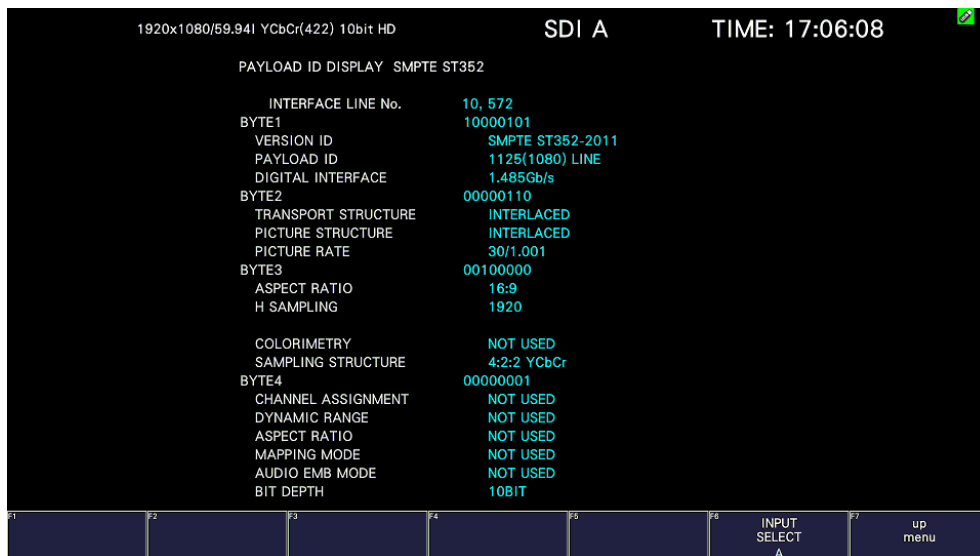

Figure 16-44 Payload ID display

- Selecting the Displayed Stream

When the input signal is 3G, to set the display stream to STREAM1 or STREAM2, press **F•4** STREAM SELECT.

- Selecting the Content to Display

You can select the displayed content using **F•5** LINK when the input signal is multi link and **F•5** SUB when the input signal is 6G or 12G.

16. STATUS DISPLAY

- Displaying IP signal ST2110-40

When the input signal is an IP signal, if the IP Type is ST2110 and the payload ID is inserted in ST2110-40, it will be displayed. The SDI Output column shows the payload ID inserted in the SDI output during IP / SDI conversion, and the ST2110-40 column shows the payload ID inserted in ST2110-40.

When SDI Out PID Insert is set to MOSFET (SDP), SDI Output is displayed as SDI Output (SDP). When set to Manual, SDI Output is displayed as SDI Output (Manual).

3840x2160/50P YCbCr(422) 10bit		IP	TIME: 11:55:41
PAYLOAD ID DISPLAY SMPTE ST352			
LINK 1[A]	SDI Output		ST2110-40
INTERFACE LINE No.	10		
BYTE1	10010111 [97]		11001110 [CE]
VERSION ID	SMPTE ST352-2011		SMPTE ST352-2011
PAYLOAD ID	2160 LINE		2160 LINE
DIGITAL INTERFACE	3Gb/s LEVEL-A QUAD LINK		12Gb/s
BYTE2	11001001 [C9]		11001001 [C9]
TRANSPORT STRUCTURE	PROGRESSIVE		PROGRESSIVE
PICTURE STRUCTURE	PROGRESSIVE		PROGRESSIVE
HDR / SDR	SDR		SDR
PICTURE RATE	50		50
BYTE3	10000000 [80]		10000000 [80]
ASPECT RATIO	16:9		16:9
H SAMPLING	1920		1920
COLORIMETRY	REC 709		REC 709
SAMPLING STRUCTURE	4:2:2 YCbCr		4:2:2 YCbCr
BYTE4	00000001 [01]		00000001 [01]
CHANNEL ASSIGNMENT	3G-SDI LINK1		12G-SDI
LUMINANCE / COLOR	YCbCr		YCbCr
AUDIO EMB MODE	ADD CH or NOT PRESENT		ADD CH
BIT DEPTH	10BIT		10BIT

Figure 16-45 Payload ID display (ST2110-40)

16. STATUS DISPLAY

16.10.4 Displaying Audio Control Packets

To display audio control packets, follow the procedure below.

Procedure

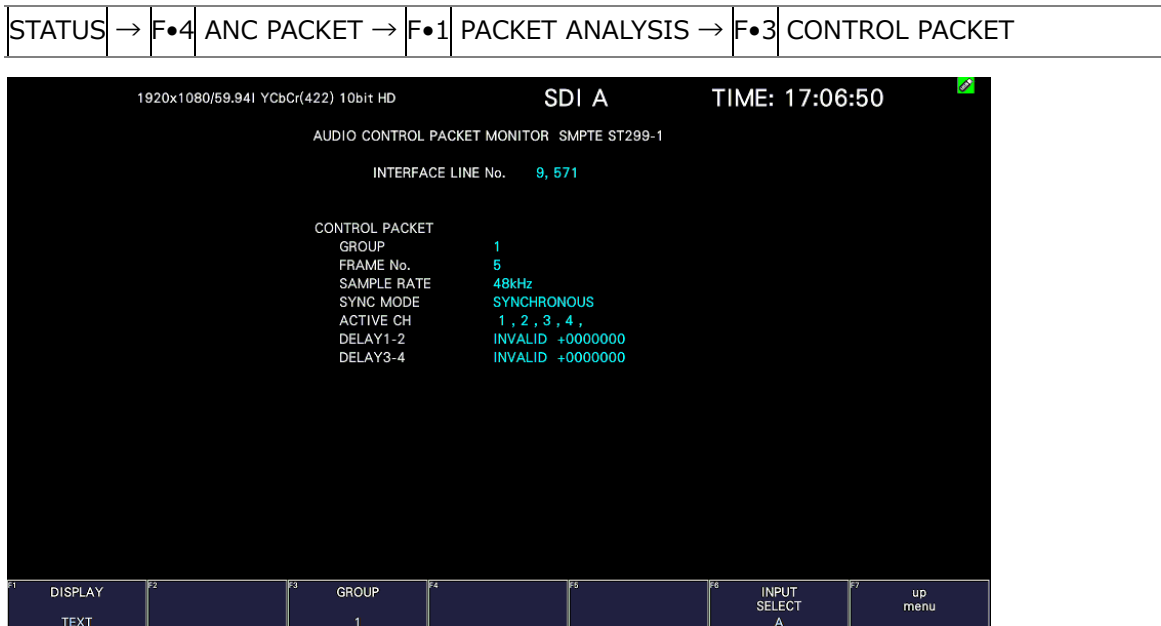

Figure 16-46 Audio control packet screen

- Selecting the Display Format

You can use **F•1** DISPLAY to set the display format to TEXT (text display) or DUMP (dump display).

If you select DUMP, the dump display appears, and you can use the function dial (F•D) to view the entire data. If you press the function dial (F•D), the first data entry is displayed.

- Selecting the Dump Mode

When **F•1** DISPLAY is set to DUMP, you can use **F•2** DUMP MODE to set the dump mode to HEX (hexadecimal display) or BINARY (binary display).

- Selecting the Group to Display

You can use **F•3** GROUP to set the group to display to a group from groups 1 to 4. A single group in the audio signal consists of four channels.

- Selecting the Displayed Stream

When the input signal is 3G-B, to set the display stream to STREAM1 or STREAM2, press **F•4** STREAM SELECT.

- Selecting the Content to Display

You can select the displayed content using **F•5** LINK when the input signal is multi link and **F•5** SUB when the input signal is 6G or 12G.

16. STATUS DISPLAY

16.10.5 V-ANC ARIB Display

To display the V blanking ancillary packets defined in the ARIB standard, use the ARIB menu.

This menu item is not displayed when the input signal is 3G-B.

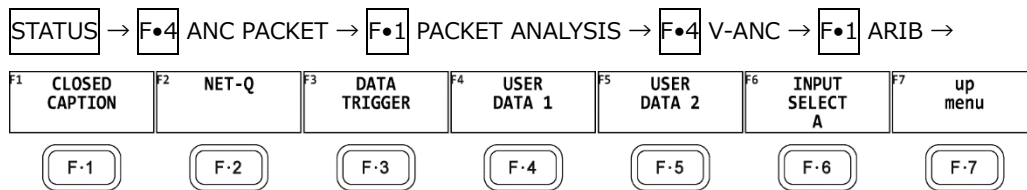

Figure 16-47 V-ANC ARIB menu

16.10.6 Displaying Closed Caption Packets

To display closed caption packets, follow the procedure below.

Procedure

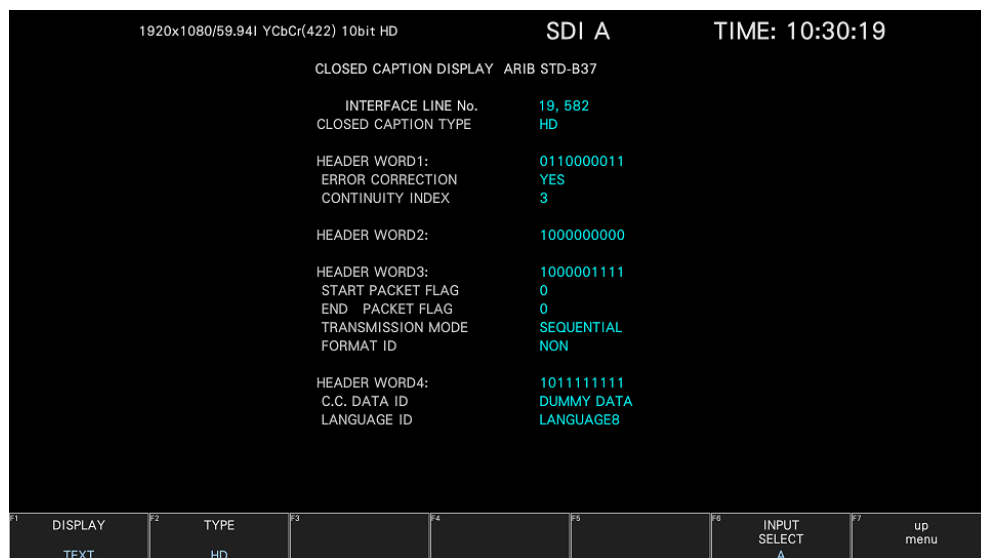
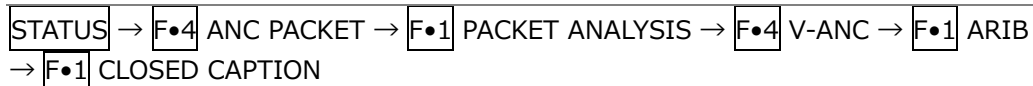

Figure 16-48 Closed caption packet screen

- Selecting the Closed Caption Type

You can use F•2 TYPE to set the closed caption type to HD, SD, ANALOG, or CELLULAR.

- Selecting the Display Format

You can use F•1 DISPLAY to set the display format to TEXT (text display) or DUMP (dump display).

If you select DUMP, the dump display appears, and you can use the function dial (F•D) to view the entire data. If you press the function dial (F•D), the first data entry is displayed.

- Selecting the Dump Mode

When F•1 DISPLAY is set to DUMP, you can use F•3 DUMP MODE to set the dump mode to HEX (hexadecimal display) or BINARY (binary display).

16. STATUS DISPLAY

- Selecting the Content to Display

You can select the displayed content using **F•5** LINK when the input signal is multi link and **F•5** SUB when the input signal is 6G or 12G.

16.10.7 Displaying the Inter-Stationary Control Signal

To display the inter-stationary control signal, follow the procedure below.

Procedure

STATUS → **F•4** ANC PACKET → **F•1** PACKET ANALYSIS → **F•4** V-ANC → **F•1** ARIB
→ **F•2** NET-Q

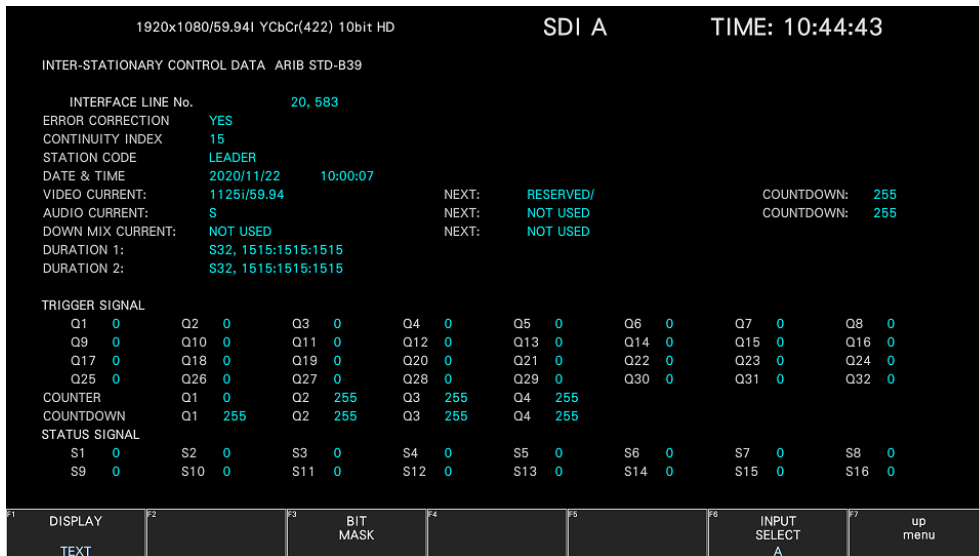

Figure 16-49 Inter-stationary control signal screen (TEXT)

- Selecting the Display Format

You can use **F•1** DISPLAY to set the display format to TEXT (text display), DUMP (dump display), Q LOG (Q-signal log display), or FORMAT (format ID display).

If you select DUMP, the dump display appears. If you select Q LOG, the log display appears. In either case, you can use the function dial (**F•D**) to view the entire data. If you press the function dial (**F•D**), the first data entry is displayed.

16. STATUS DISPLAY

- Selecting the Dump Mode

When **F•1** DISPLAY is set to DUMP, you can use **F•2** DUMP MODE to set the dump mode to HEX (hexadecimal display) or BINARY (binary display).

- Clearing the Q-Signal Log

When **F•1** DISPLAY is set to Q LOG, press **F•2** Q LOG CLEAR to clear the Q-signal log.

- Setting the Bit Mask

When **F•1** DISPLAY is set to TEXT, you can use **F•3** BIT MASK to mask the Q and status signals independently.

Press **F•4** ALL ON to select all the check boxes. Press **F•5** ALL OFF to clear all the check boxes.

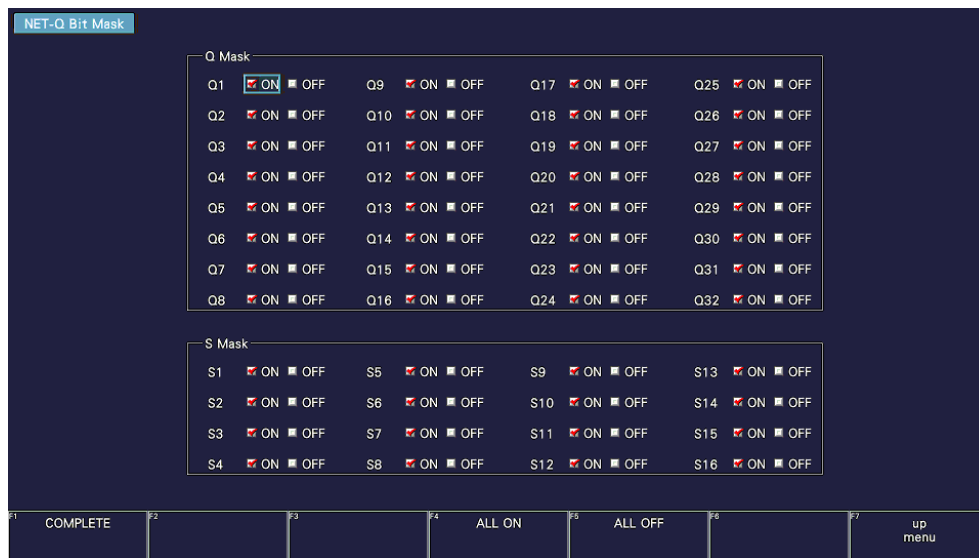

Figure 16-51 NET-Q Bit Mask tab

- Selecting the Content to Display

You can select the displayed content using **F•5** LINK when the input signal is multi link and **F•5** SUB when the input signal is 6G or 12G.

- Saving data to a USB memory device

If **F•1** DISPLAY is set to Q LOG, you can press **F•6** USB MEMORY to save the Q signal log to a USB memory device in CSV format. The procedure to follow to save data is the same as the procedure that was given for the event log. See section 16.4.5, "Saving to a USB Memory Device."

Q signal logs are saved in the NETQ folder.

- 📁 USB memory device
 - ↳ 📁 LV5600_USER or LV7600_USER
 - ↳ 📁 NETQ
 - ↳ 📄 YYYYMMDDhhmmss.csv

16. STATUS DISPLAY

16.10.8 Displaying the Data Broadcast Trigger Signal

To display the data broadcast trigger signal, follow the procedure below.

Procedure

STATUS → F•4 ANC PACKET → F•1 PACKET ANALYSIS → F•4 V-ANC → F•1 ARIB
→ F•3 DATA TRIGGER



Figure 16-52 Data broadcast trigger signal screen

- Selecting the Display Format

You can use F•1 DISPLAY to set the display format to TEXT (text display) or DUMP (dump display).

If you select DUMP, the dump display appears, and you can use the function dial (F•D) to view the entire data. If you press the function dial (F•D), the first data entry is displayed.

- Selecting the Dump Mode

When F•1 DISPLAY is set to DUMP, you can use F•2 DUMP MODE to set the dump mode to HEX (hexadecimal display) or BINARY (binary display).

- Selecting the Content to Display

You can select the displayed content using F•5 LINK when the input signal is multi link and F•5 SUB when the input signal is 6G or 12G.

16. STATUS DISPLAY

16.10.9 Displaying User Data

To display user data 1 or 2, follow the procedure below.

You can use the function dial (F•D) to view all the data. If you press the function dial (F•D), the first data entry is displayed.

Procedure

STATUS → F•4 ANC PACKET → F•1 PACKET ANALYSIS → F•4 V-ANC → F•1 ARIB
 → F•4 USER DATA 1
 → F•5 USER DATA 2

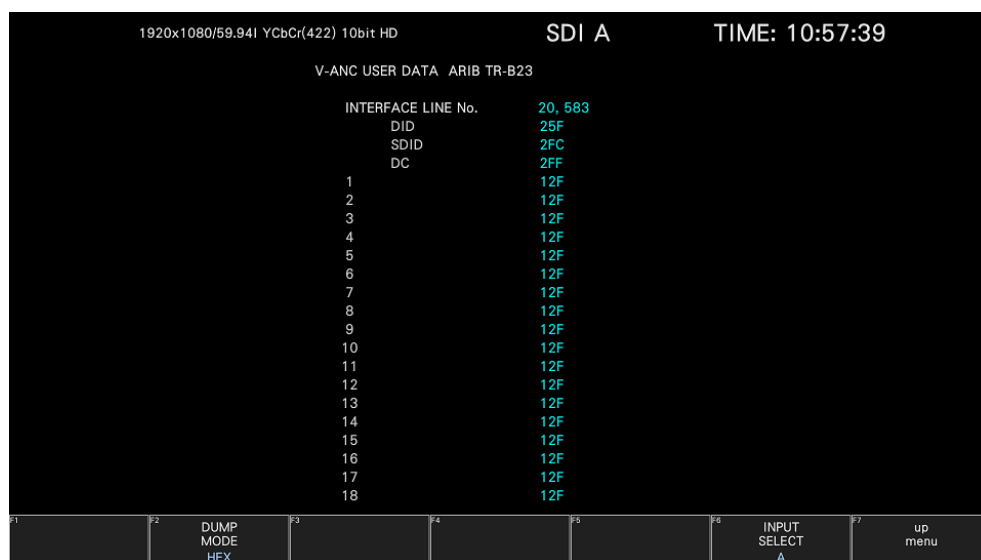

Figure 16-53 User data display

- Selecting the Dump Mode

You can use F•2 DUMP MODE to set the dump mode to HEX (hexadecimal display) or BINARY (binary display).

- Selecting the Content to Display

You can select the displayed content using F•5 LINK when the input signal is multi link and F•5 SUB when the input signal is 6G or 12G.

16.10.10 V-ANC SMPTE Display

To display the V blanking ancillary packets defined in the SMPTE standard, use the SMPTE menu.

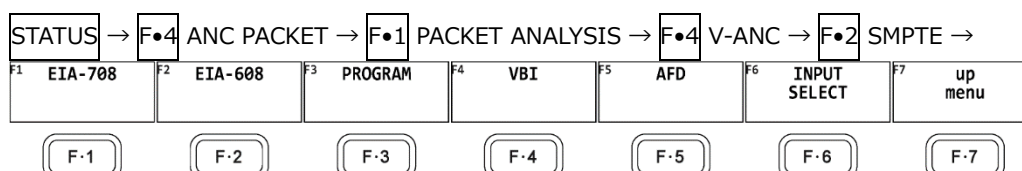

Figure 16-54 SMPTE menu

16. STATUS DISPLAY

16.10.11 Displaying EIA-708 Data

To display data that is specified by the EIA-708 standard, follow the procedure below.

Procedure

STATUS → F•4 ANC PACKET → F•1 PACKET ANALYSIS → F•4 V-ANC → F•2 SMPTE
→ F•1 EIA-708

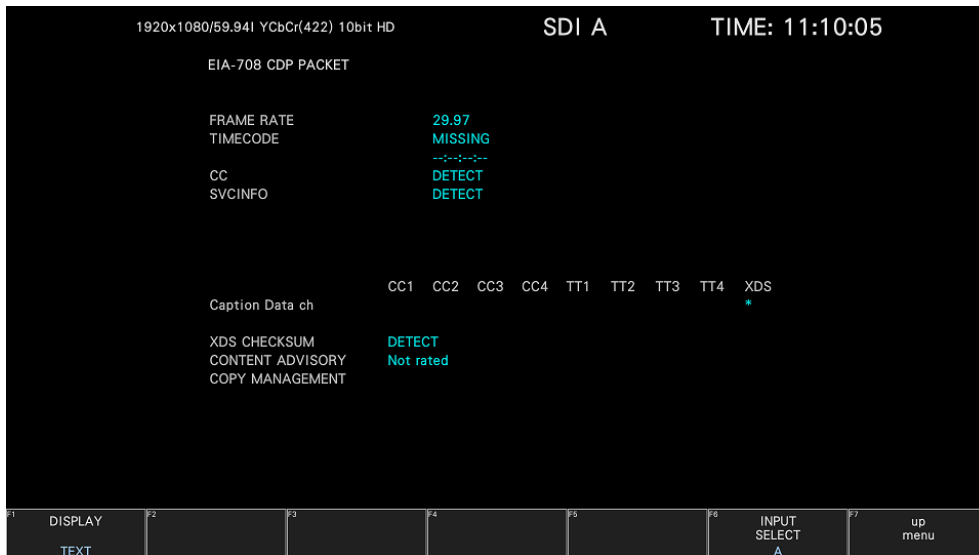

Figure 16-55 EIA-708 data display

- Selecting the Display Format

You can use F•1 DISPLAY to set the display format to TEXT (text display) or DUMP (dump display).

If you select DUMP, the dump display appears, and you can use the function dial (F•D) to view the entire data. If you press the function dial (F•D), the first data entry is displayed.

- Selecting the Dump Mode

When F•1 DISPLAY is set to DUMP, you can use F•2 DUMP MODE to set the dump mode to HEX (hexadecimal display) or BINARY (binary display).

- Selecting the Content to Display

You can select the displayed content using F•5 LINK when the input signal is multi link and F•5 SUB when the input signal is 6G or 12G.

16. STATUS DISPLAY

16.10.12 Displaying EIA-608 Data

To display data that is specified by the EIA-608 standard, follow the procedure below.

Procedure

STATUS → F•4 ANC PACKET → F•1 PACKET ANALYSIS → F•4 V-ANC → F•2 SMPTE
→ F•2 EIA-608

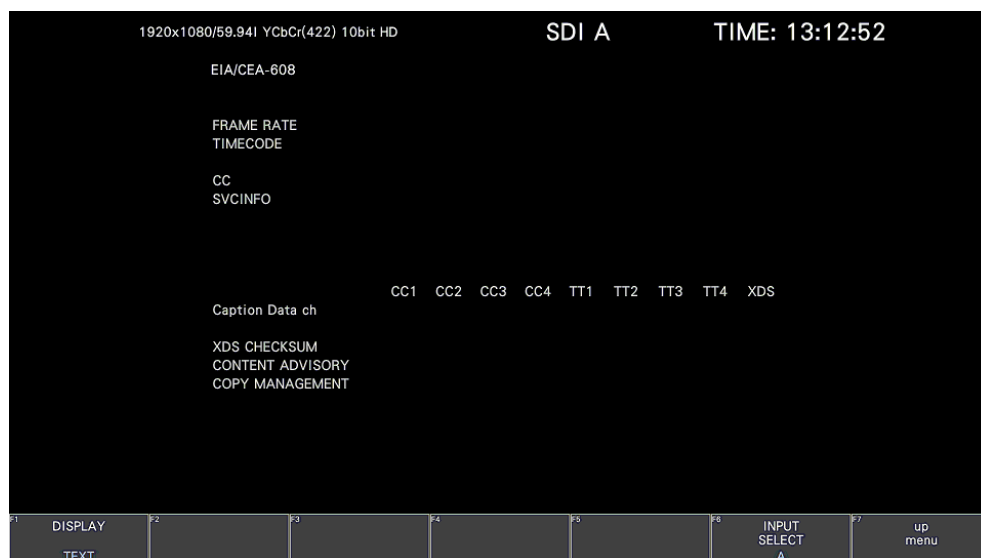

Figure 16-56 EIA-608 data display

- Selecting the Display Format

You can use F•1 DISPLAY to set the display format to TEXT (text display) or DUMP (dump display).

If you select DUMP, the dump display appears, and you can use the function dial (F•D) to view the entire data. If you press the function dial (F•D), the first data entry is displayed.

- Selecting the Dump Mode

When F•1 DISPLAY is set to DUMP, you can use F•2 DUMP MODE to set the dump mode to HEX (hexadecimal display) or BINARY (binary display).

- Selecting the Content to Display

You can select the displayed content using F•5 LINK when the input signal is multi link and F•5 SUB when the input signal is 6G or 12G.

16. STATUS DISPLAY

16.10.13 Displaying Program Data

To display whether program description packets that are specified by the ATSC A/65 standard are present, follow the procedure below. For each descriptor, if its ID is present, "DETECT" is displayed; if its ID is not present, "MISSING" is displayed.

Procedure

STATUS → F•4 ANC PACKET → F•1 PACKET ANALYSIS → F•4 V-ANC → F•2 SMPTE
→ F•3 PROGRAM

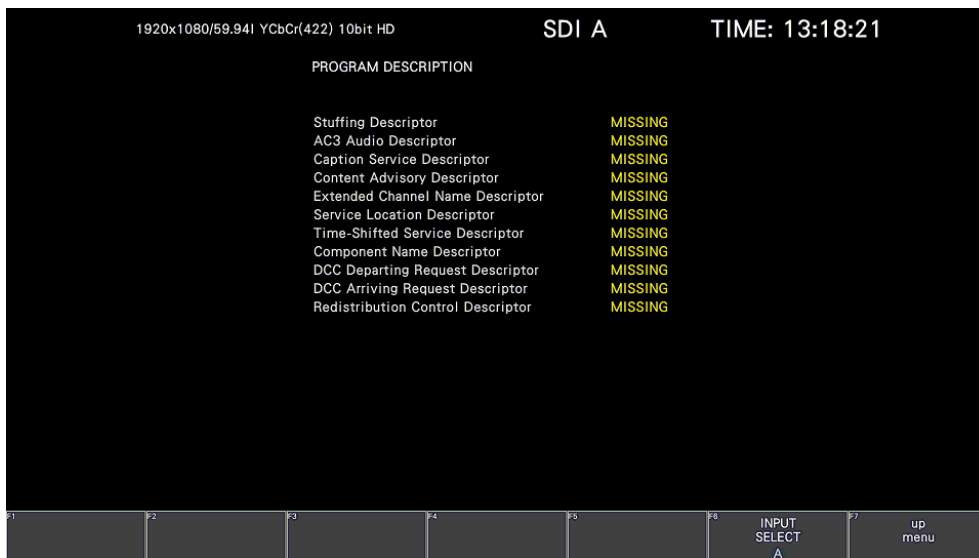

Figure 16-57 Program data display

- Selecting the Content to Display

You can select the displayed content using F•5 LINK when the input signal is multi link and F•5 SUB when the input signal is 6G or 12G.

16. STATUS DISPLAY

16.10.14 Displaying VBI Data

When the input signal is SD, to display VBI data, follow the procedure below.

Procedure

STATUS → F•4 ANC PACKET → F•1 PACKET ANALYSIS → F•4 V-ANC → F•2 SMPTE
→ F•4 VBI



Figure 16-58 VBI data display

- Selecting the Content to Display

You can select the displayed content using F•5 LINK when the input signal is multi link and F•5 SUB when the input signal is 6G or 12G.

16. STATUS DISPLAY

16.10.15 Displaying AFD Packets

To display AFD packets, follow the procedure below.

Procedure

STATUS → **F•4** ANC PACKET → **F•1** PACKET ANALYSIS → **F•4** V-ANC → **F•2** SMPTE
→ **F•5** AFD

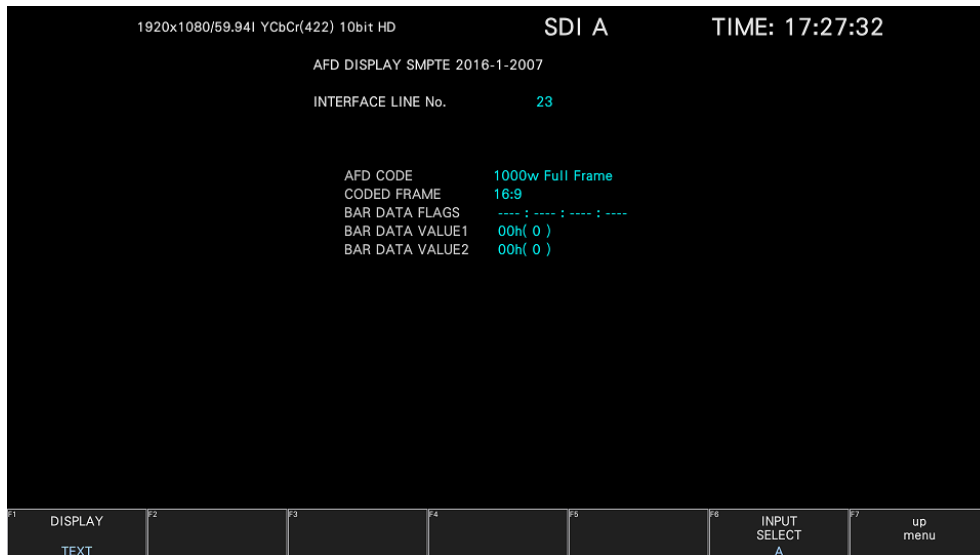

Figure 16-59 AFD packet display

- Selecting the Display Format

You can use **F•1** DISPLAY to set the display format to TEXT (text display) or DUMP (dump display).

If you select DUMP, the dump display appears, and you can use the function dial (F•D) to view the entire data. If you press the function dial (F•D), the first data entry is displayed.

- Selecting the Dump Mode

When **F•1** DISPLAY is set to DUMP, you can use **F•2** DUMP MODE to set the dump mode to HEX (hexadecimal display) or BINARY (binary display).

- Selecting the Displayed Stream

When the input signal is 3G-B, to set the display stream to STREAM1 or STREAM2, press **F•4** STREAM SELECT.

- Selecting the Content to Display

You can select the displayed content using **F•5** LINK when the input signal is multi link and **F•5** SUB when the input signal is 6G or 12G.

16. STATUS DISPLAY

16.10.16 Configuring the SCTE-104 Detection Display settings

To display SCTE-104 packets, follow the procedure below.

Procedure

STATUS → F•4 ANC PACKET → F•1 PACKET ANALYSIS → F•4 V-ANC → F•3 SCTE /
CAMERA META → F•1 SCTE-104

• Selecting the Display Format

You can use F•1 DISPLAY to set the display format to TEXT (text display), DUMP (dump display), or SPLICE (splice display).

If you select TEXT, the text display appears, the currently received packets are displayed in blue, and they are also recorded as the event log.

If you select DUMP, the dump display appears, and you can turn the function dial (F•D) to view the entire data. If you press the function dial (F•D), the first entry data is displayed.

If you select SPLICE, the splice display appears, and when a splice_request_data message is detected, the message appears.

TEXT / DUMP / SPLICE

• Selecting the Text Mode

When F•1 DISPLAY is set to TEXT, you can use F•2 DURTION to select the display time from 1 to 10 seconds for SCTE-104 packets.

Changing this setting will not change the display time on the SCTE-104 SETUP tab in the picture display in conjunction.

1 / 2 / 3 / 4 / 5 / 6 / 7 / 8 / 9 / 10

• Updating the dump display

When F•1 DISPLAY is set to DUMP, you can select the update time of the dump display, follow the procedure below.

Procedure

STATUS → F•4 ANC PACKET → F•1 PACKET ANALYSIS → F•4 V-ANC → F•3 SCTE /
CAMERA META → F•1 SCTE-104 → F•2 HOLD TIME: HOLD / 1s / 3s

Settings

HOLD:	Does not update the screen.
1s:	Updates the screen every second.
3s:	Updates the screen every 3 seconds.

16. STATUS DISPLAY

- Starting the Event Log

When **F•1** DISPLAY is set to TEXT or SPLICE, you can start the event log, follow the procedure below.

Procedure

STATUS → **F•4** ANC PACKET → **F•1** PACKET ANALYSIS → **F•4** V-ANC → **F•3** SCTE /
CAMERA META → **F•1** SCTE-104 → **F•3** LOG: START / STOP

Settings

START: The event log is started. "NOW LOGGING" appears in the upper right of the event log.

STOP: The event log is stopped. "LOGGING STOPPED" appears in the upper right of the event log.

- Clearing the Event Log

When **F•1** DISPLAY is set to TEXT or SPLICE, you can clear the event log, follow the procedure below.

Procedure

STATUS → **F•4** ANC PACKET → **F•1** PACKET ANALYSIS → **F•4** V-ANC → **F•3** SCTE /
CAMERA META → **F•1** SCTE-104 → **F•4** CLEAR

- Selecting the Dump Mode

When **F•1** DISPLAY is set to DUMP, you can use **F•2** DUMP MODE to set the dump mode to HEX (hexadecimal display) or BINARY (binary display).

16. STATUS DISPLAY

16.10.17 Displaying the SCTE-104 Detection screen

- TEXT Display

When a SCTE-104 message is detected, the message is displayed in blue. The message display time is displayed only for the time set in Duration, and if no message is detected during the set time, all detected messages are grayed out.

You can also log up to 1000 detected messages. Set **F•3** LOG to START to start logging.

To stop logging, set **F•3** LOG to STOP, and to clear the log, press **F•4** CLEAR. **F•3** LOG

START / STOP is linked to the SPLICE display. You can output the log as a file by inserting the USB memory device.

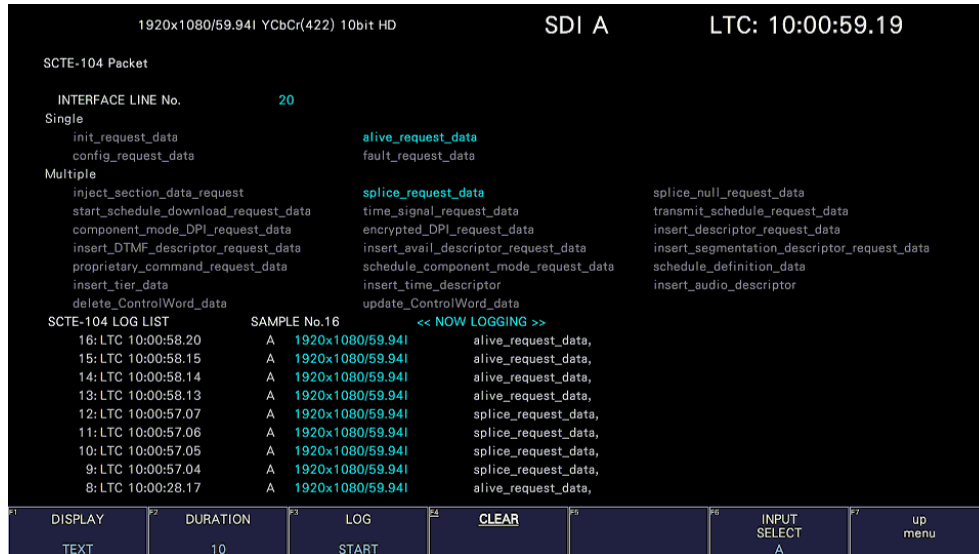

Figure 16-60 SCTE-104 detection screen (TEXT display)

- DUMP Display

When a SCTE-104 message is detected, the dump data of the message is displayed.

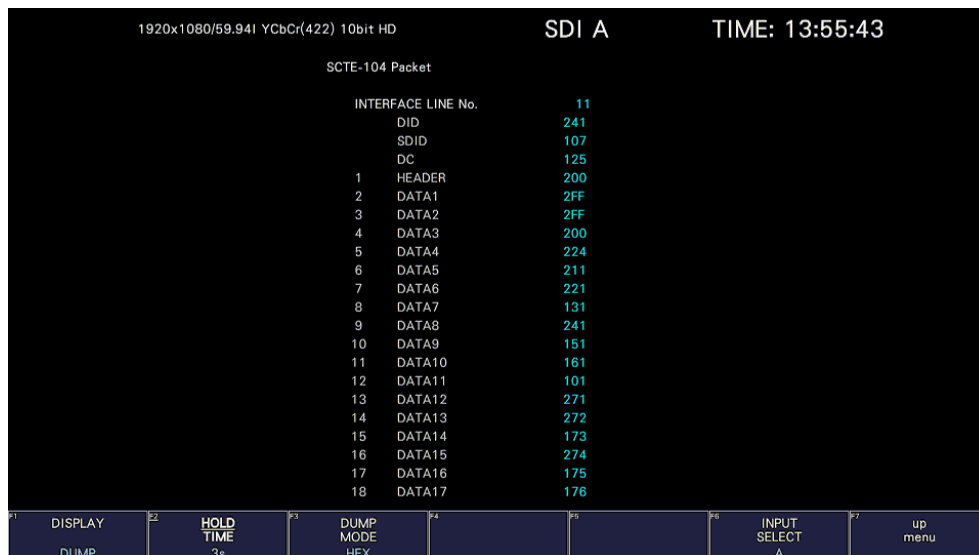

Figure 16-61 SCTE-104 detection screen (DUMP display)

16. STATUS DISPLAY

- SPLICE Display

When a splice_request_data message is detected, the message is displayed.

You can log up to 1000 detected the splice_request_data messages. To display the details of the message, turn the function dial (F•D) to select the target message. Set **F•3** LOG to START to start logging. To stop logging, set **F•3** LOG to STOP, and to clear the log, press **F•4** CLEAR. **F•3** LOG START / STOP is linked to the TEXT display. You can output the log as a file by inserting the USB memory device.

You can change the ID display setting with **F•2** ID Value. It is linked with the ID Value on the SCTE-104 SETUP tab of the picture screen. When ID Value is set to BOTH, splice_event_id and unique_program_id are displayed simultaneously in hexadecimal and decimal numbers as shown below.

```
splice_event_id      Hexadecimal (decimal)
unique_program_id    Hexadecimal (decimal)
```

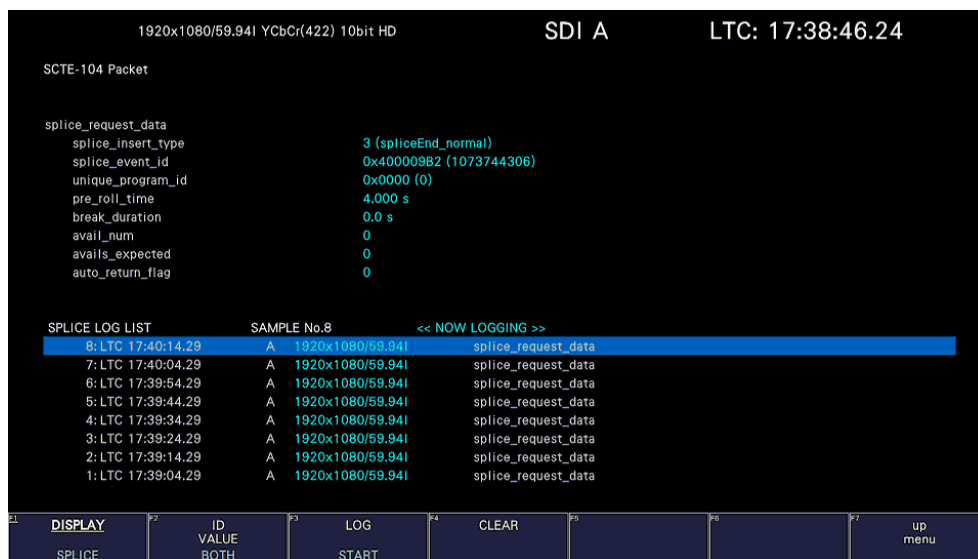

Figure 16-62 SCTE-104 detection screen (SPLICE display)

16. STATUS DISPLAY

16.10.18 Displaying SR Live Packets

To display SR Live packets, follow the procedure below.

Procedure

STATUS → F•4 ANC PACKET → F•1 PACKET ANALYSIS → F•4 V-ANC → F•3 SCTE / CAMERA META → F•2 SR Live

1920x1080/59.94P YCbCr(422) 10bit 3G-B-DL			SDI A		TIME: 15:04:07		
SR Live Packet							
INTERFACE LINE No. 14							
No.	ITEM	VALUE	CTRL[Abs]	No.	ITEM	VALUE	CTRL[Abs]
1	Table Version	V 1.00	--	14	Knee	OFF	OFF
2	OETF	HLG	--	15	Knee Point	96%	[-15]
3	Transfer Matrix	BT.2020	--	16	Knee Slope	0.19	[+37]
4	Color Gamut	WIDE-BC	--	17	Knee Saturation	OFF	OFF
5	Conversion Mode	SR AIR ON	--	18	Knee Saturation Level	0.50	[+0]
6	HDR Look	Live	Live	19	Soft Knee	--	--
7	HDR Black Compression	ON	ON	20	Knee Radius	--	--
8	SDR Gain	-5.2dB	[-5.2dB]	21	SDR White Clip	ON	ON
9	Master Black	1.03%	[+4.7]	22	SDR White Clip Level	109%	[-94]
10	HDR Black Offset	Δ-0.99%	[-4.5]	23	HDR Knee	OFF	OFF
11	Gamma Table	STD 5	STD 5	24	HDR Knee Point	349%	[+0]
12	Gamma Step	0.45	0.45	25	HDR Knee Slope	0.65	[+0]
13	Gamma Level	0.95	[-12]	26	HDR Target White	203nit	--

Figure 16-63 SR Live packet display(TEXT display)

- Selecting the Display Format

You can use F•1 DISPLAY to set the display format to TEXT (text display) or DUMP (dump display).

If you select DUMP, the dump display appears, and you can turn the function dial (F•D) to view the entire data. If you press the function dial (F•D), the first entry data is displayed.

- Selecting the Dump Mode

When F•1 DISPLAY is set to DUMP, you can use F•2 DUMP MODE to set the dump mode to HEX (hexadecimal display) or BINARY (binary display).

- Selecting the Displayed Stream

When the input signal is 3G-B, to set the display stream to STREAM1 or STREAM2 by pressing F•4 STREAM SELECT.

- Selecting the Content to Display

You can select the displayed content using F•5 LINK when the input signal is multi link and F•5 SUB when the input signal is 6G or 12G.

16. STATUS DISPLAY

16.10.19 Performing Custom Searches

To show the custom search screen, follow the procedure below.

You can use the function dial (F•D) to view all the data. If you press the function dial (F•D), the first data entry is displayed.

Procedure

STATUS → F•4 ANC PACKET → F•1 PACKET ANALYSIS → F•5 CUSTOM SEARCH

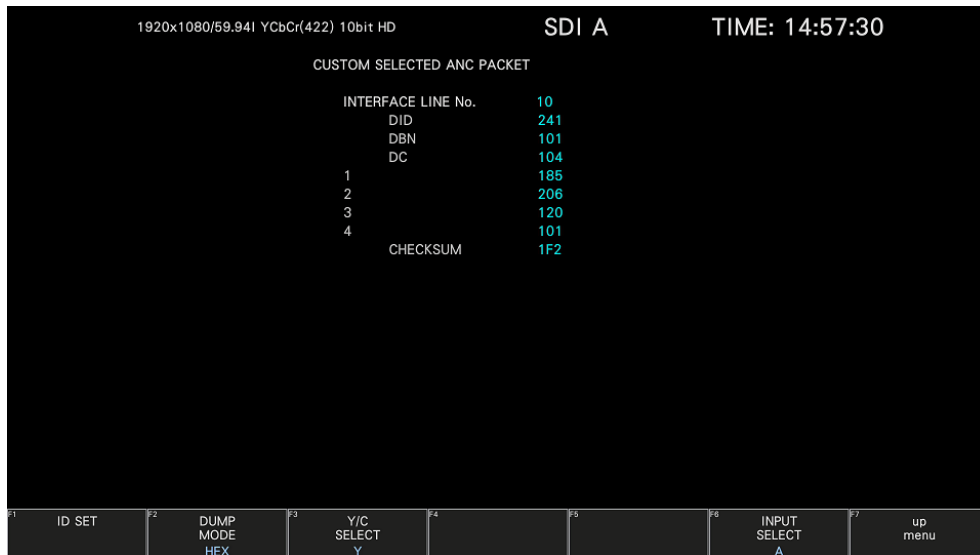

Figure 16-64 Custom search screen

• Detecting Ancillary Packets

You can search ancillary packets by using F•1 ID SET in the CUSTOM SEARCH menu.

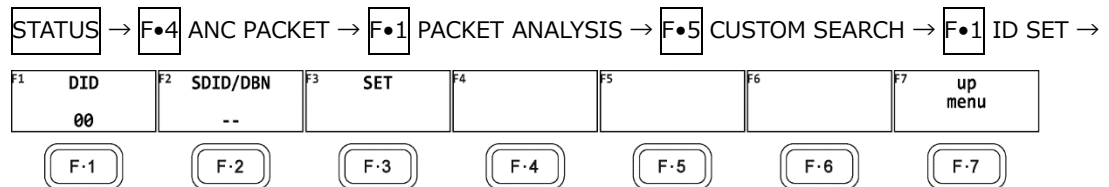

Figure 16-65 ID SET menu

Set F•1 DID and F•2 SDID/DBN to display ancillary packets on the basis of the combination of the DID and SDID/DBN.

You can set F•1 DID in the range of 00 to FF. Press the function dial (F•D) to return the setting to its default value (00).

You can set F•2 SDID/DBN in the range of 00 to FF or select "--" to not specify a value. Press the function dial (F•D) to return the setting to its default value (--).

Press F•3 SET to clear the blue cursor assigned to F•1 DID or F•2 SDID/DBN. Use this key when you want to view all the data using the function dial (F•D).

• Selecting the Dump Mode

You can use F•2 DUMP MODE to set the dump mode to HEX (hexadecimal display) or BINARY (binary display).

16. STATUS DISPLAY

- Selecting Which Signal to Display

When the input signal is not SD, you can use **F•3** Y/C SELECT to set the signal to display to Y signal or C signal.

- Selecting the Displayed Stream

When the input signal is 3G-B, to set the display stream to STREAM1 or STREAM2, press **F•4** STREAM SELECT.

- Selecting the Content to Display

You can select the displayed content using **F•5** LINK when the input signal is multi link and **F•5** SUB when the input signal is 6G or 12G.

17. EYE PATTERN DISPLAY (SER02/SER02A)

The functions of SER02 and SER02A are the same.

To display the eye pattern, press EYE.

On the eye pattern display you can use **F•1** EYE/JITTER INTEN/CONFIG → **F•1** EYE/JITTER MODE to display the eye pattern or jitter.

The SDI signal applied to SDI INPUT 1 is displayed.

If **F•6** INPUT SELECT is set to a signal other than what is applied to SDI INPUT 1, the message “Not Supported” appears, and the eye pattern nor jitter is displayed. Simul mode are not supported.

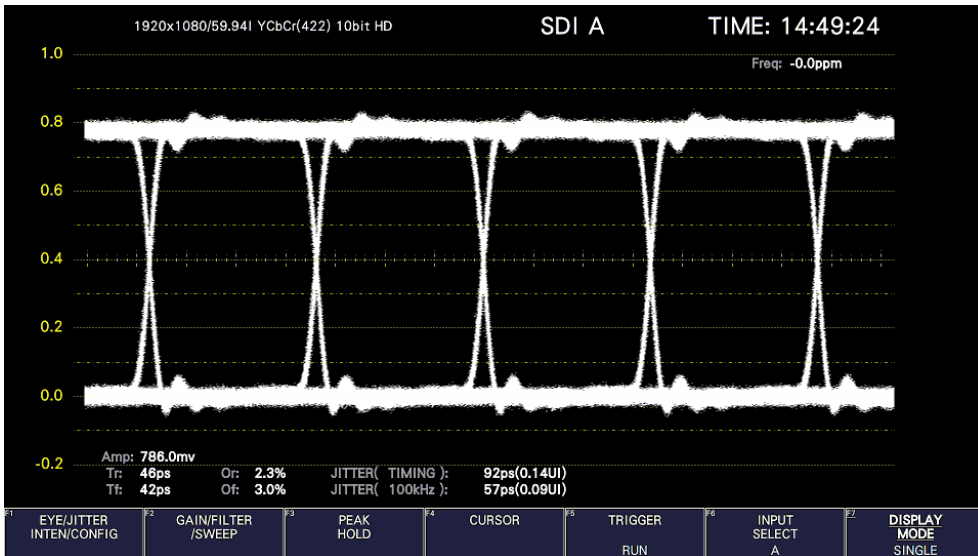

Figure 17-1 Eye pattern display

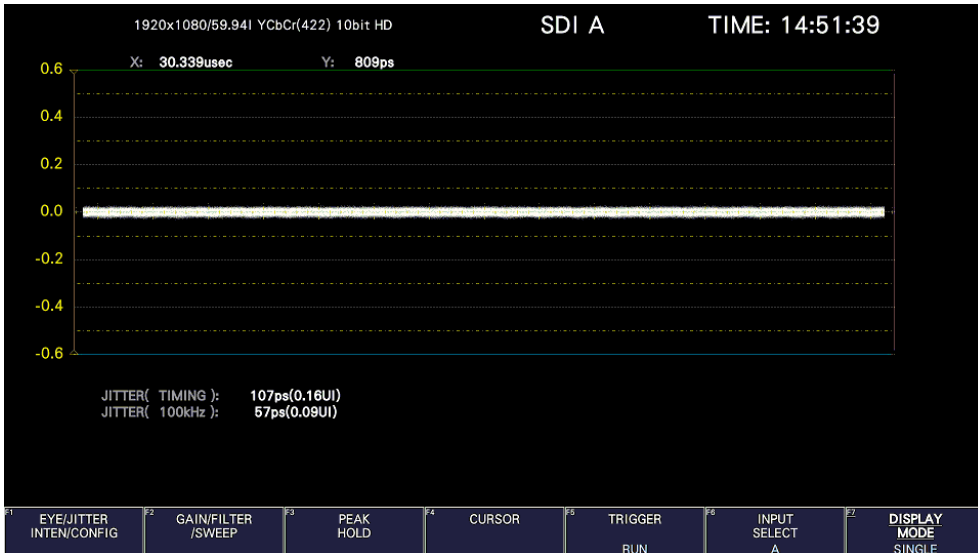

Figure 17-2 Jitter display

17. EYE PATTERN DISPLAY (SER02/SER02A)

- Displaying the Eye Pattern and Jitter Simultaneously

By using the customized layout feature (SER26), you can display the eye pattern and jitter simultaneously.

[See also] 6.5, "Customized Layout (SER26)"

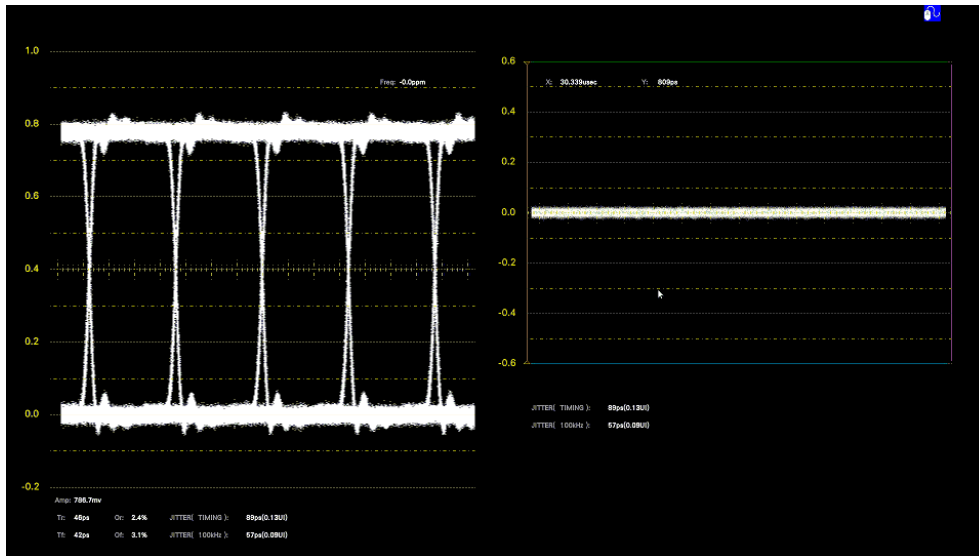

Figure 17-3 Eye pattern and jitter display

17.1 Eye Pattern Display Description

- Automatic Measurement

On the eye pattern display, values such as the amplitude of the eye pattern and the jitter are measured automatically and displayed. Measured values are normally displayed in white, but they are displayed in yellow until they stabilize and in red if they exceed the values that you have specified in the error setup. If automatic measurements cannot be performed due to noise in the waveform or other reason, measured values are displayed as "----." If this occurs, use cursors to measure manually.

[See also] Reference 17.8, "Configuring Error Detection Settings"

The timing jitter and jitter measurement items show the values that were measured in jitter display mode. The instrument uses the phase demodulator method.

Other measurement items show the measured values calculated from the eye pattern waveform. Therefore, if the waveform degrades significantly, the difference between the automatically measured values and the cursor-measured values may become large.

- Measurement items

The items that can be automatically measured are shown below.

Table 17-1 Measurement items

Symbol	Display	Description
a	Amp	Eye-pattern amplitude
b	Tr	Rise time (time from 20% to 80% of amplitude)
c	Tf	Fall time (time from 80% to 20% of amplitude, figure omitted)
d	T.J	Timing Jitter
e	JIT	Jitter (jitter value when the currently selected filter is applied)
f	Or	Overshoot of the rising edge
g	Of	Overshoot of the falling edge

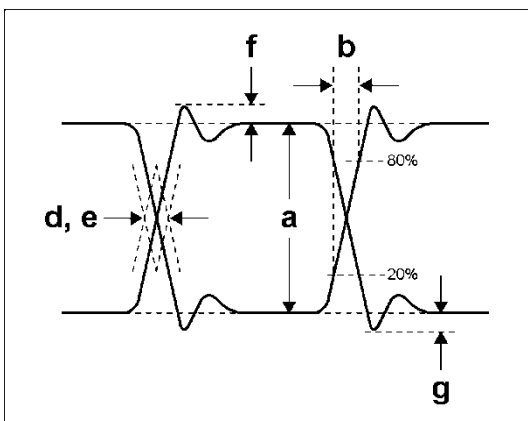

Figure 17-4 Explanation of measurement items

17. EYE PATTERN DISPLAY (SER02/SER02A)

- Unit interval

This unit uses unit intervals (UI) as jitter measurement units.

One cycle of the eye pattern is 1 UI. The time that corresponds to 1 UI varies depending on the input signal, as shown below.

Table 17-2 Time that corresponds to 1 UI

Input Signal	Bit Rate	Time That Corresponds to 1 UI
3G	2.970/1.001 Gbps	337.0 ps
	2.970 Gbps	336.7 ps
HD	1.485/1.001 Gbps	674.1 ps
	1.485 Gbps	673.4 ps
SD	270 Mbps	3.7 ns

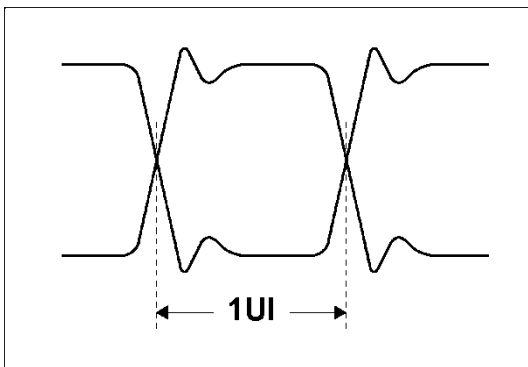

Figure 17-5 Unit interval

- Histogram display

The histogram is superimposed on the eye pattern display and shows amplitude information of the eye pattern waveform, such as the amount of eye opening, amplitude position, superimposed noise, rising edge overshoot (Or), and falling edge overshoot (Of).

17.2 Jitter Display Description

- Measurement

In the jitter display mode, the jitter component is extracted from the input signal and plotted on a time graph. The time (horizontal) axis can be displayed in different ways depending on the data interval of the lines, fields, or frames, which are being transmitted in the SDI signal.

- Automatic Measurement

Timing jitter (T.J) and jitter (JIT) are automatically measured and displayed on the jitter display screen. The measurement range is 0.00 to 9.60 UI.

SMPTE defines two methods of measuring jitter. One method uses an eye pattern, and the other method uses a phase demodulator.

The eye pattern method has disadvantages not only that measurements are difficult when the eye is not open but that measurements are prone to errors because the distinction between waveform distortion (such as noise and sags) and jitter is difficult.

In contrast, the phase demodulator method makes jitter measurements with small errors possible even when the eye pattern is closed and even when the amount of jitter is 1 UI or more.

The unit use the phase demodulator method.

Measured values are normally displayed in white, but they are displayed in red if they exceed the values that you have specified in the error setup. If 10.00 UI is exceeded, "OVER" is displayed.

[See also] Reference 17.8, "Configuring Error Detection Settings"

17.3 Setting the Waveform Display Position

Use the V POS and H POS knobs to adjust the display position of the waveform. On the multi display, these are valid when you press **F•7** MULTI EYE on the MULTI menu.

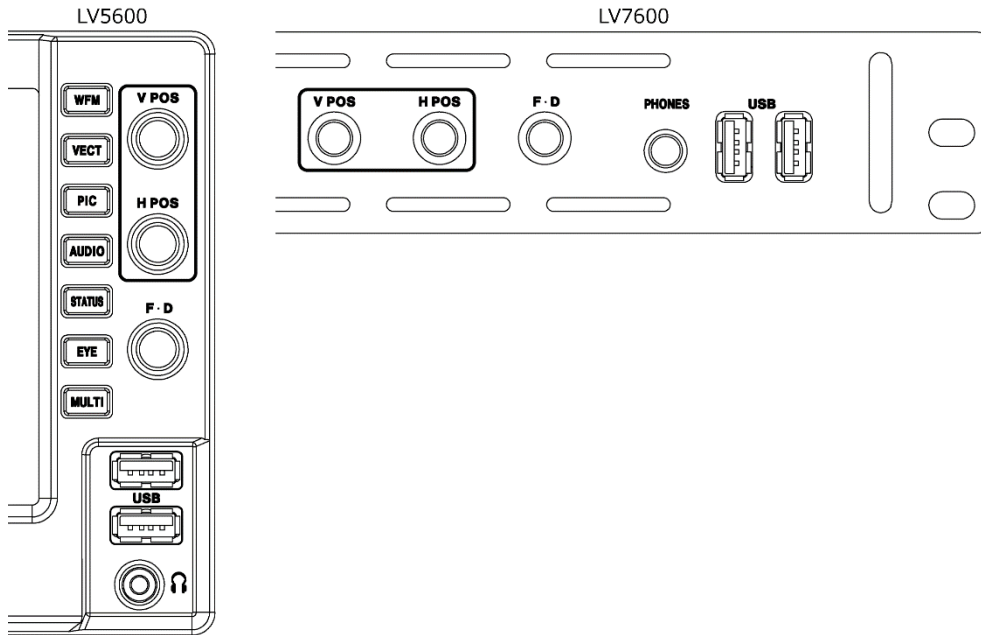

Figure 17-6 V POS and H POS knobs

- V POS Knob
Adjusts the vertical position of the waveform.
Pressing the knob returns the waveform to its default position.
- H POS Knob
Adjusts the horizontal position of the waveform.
Pressing the knob returns the waveform to its default position.

17.4 Switching between Eye Pattern and Jitter

To switch between eye pattern and jitter, follow the procedure below.

Procedure

EYE	→	F•1	EYE/JITTER INTEN/CONFIG	→	F•1	EYE/JITTER: <u>EYE</u> / JITTER
-----	---	-----	-------------------------	---	-----	---------------------------------

17. EYE PATTERN DISPLAY (SER02/SER02A)

17.5 Turning the Histogram Display On and Off

When an eye pattern is displayed, to superimpose the histogram on the eye pattern, follow the procedure below.

When in 2-screen display mode, the histogram is superimposed on the eye pattern of the selected filter.

Procedure

EYE	→	F•1	EYE/JITTER INTEN/CONFIG	→	F•2	HISTOGRAM: <u>OFF</u> / ON
-----	---	-----	-------------------------	---	-----	----------------------------

HISTOGRAM = ON

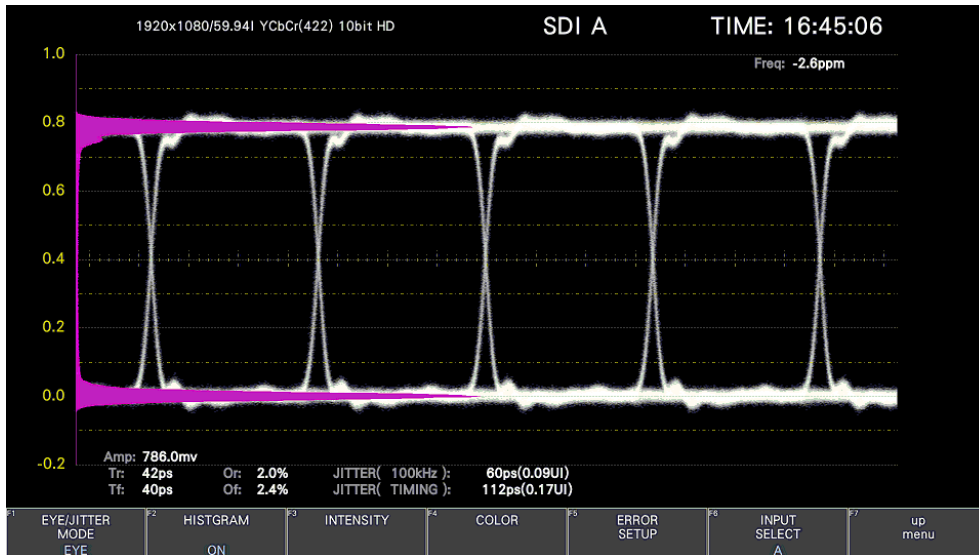

Figure 17-7 Histogram display

17.6 Setting the Intensity

Use **F•1** EYE/JITTER INTEN/CONFIG → **F•3** INTENSITY on the EYE menu to set the intensity. You can configure these settings separately for the eye pattern, histogram and jitter.

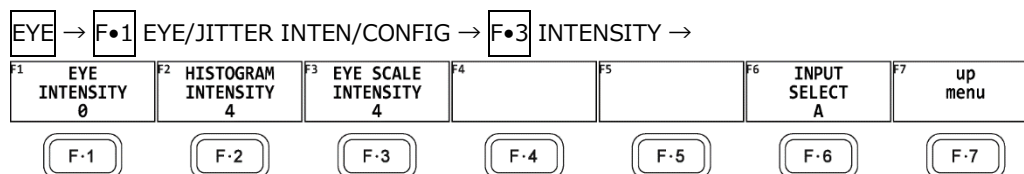

Figure 17-8 INTENSITY menu

17.6.1 Adjusting the Waveform Intensity

To adjust the intensity of the eye pattern and jitter, follow the procedure below. Press the function dial (F•D) to return the setting to its default value (0).

Procedure

EYE → **F•1** EYE/JITTER INTEN/CONFIG → **F•3** INTENSITY
 → **F•1** EYE INTENSITY: -128 - 0 - 127
 → **F•1** JITTER INTENSITY: -128 - 0 - 127

17.6.2 Adjusting the Histogram Intensity

To adjust the intensity of the histogram superimposed on the eye pattern, follow the procedure below.

Press the function dial (F•D) to return the setting to its default value (4).

Procedure

EYE → **F•1** EYE/JITTER INTEN/CONFIG → **F•3** INTENSITY
 → **F•2** HISTOGRAM INTENSITY: -8 - 4 - 7

17.6.3 Adjusting the Scale Intensity

To adjust the scale intensity, follow the procedure below.

Press the function dial (F•D) to return the setting to its default value (4).

Procedure

EYE → **F•1** INTEN/SCALE → **F•3** SCALE INTEN: -8 - 4 - 7

17.7 Selecting the Display Colors

Use **F•1** EYE/JITTER INTEN/CONFIG → **F•4** COLOR on the EYE menu to set the display colors. You can configure these settings separately for the eye pattern, histogram and jitter.

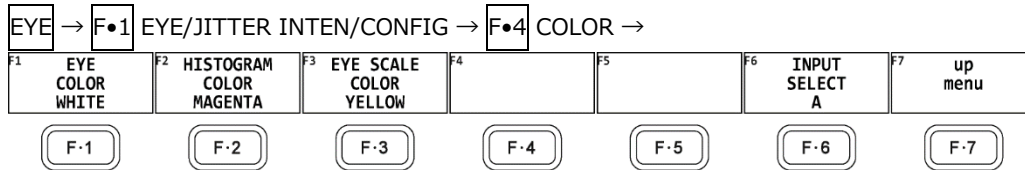

Figure 17-9 COLOR menu

17.7.1 Selecting the Waveform Color

To select the color of the eye-pattern and jitter, follow the procedure below.

Procedure

EYE → **F•1** EYE/JITTER INTEN/CONFIG → **F•4** COLOR
 → **F•1** EYE COLOR: WHITE / YELLOW / CYAN / GREEN / MAGENTA / RED / BLUE
 → **F•1** JITTER COLOR: WHITE / YELLOW / CYAN / GREEN / MAGENTA / RED / BLUE

17.7.2 Selecting the Histogram Color

To select the color of the histogram superimposed on the eye pattern, follow the procedure below.

Procedure

EYE → **F•1** EYE/JITTER INTEN/CONFIG → **F•4** COLOR
 → **F•2** HISTOGRAM COLOR: WHITE / YELLOW / CYAN / GREEN / MAGENTA / RED / BLUE

17.7.3 Selecting the Scale Color

To select the scale color, follow the procedure below.

Procedure

EYE → **F•1** EYE/JITTER INTEN/CONFIG → **F•4** COLOR
 → **F•3** EYE SCALE COLOR: WHITE / YELLOW / CYAN / GREEN / MAGENTA / RED / BLUE
 → **F•3** JITTER SCALE COLOR: WHITE / YELLOW / CYAN / GREEN / MAGENTA / RED / BLUE

17.8 Configuring Error Detection Settings

Use **F•1** EYE/JITTER INTEN/CONFIG → **F•5** ERROR SETUP on the EYE menu to set error detection.

When error detection is set to ON, the following actions are performed when an error occurs.

- Displays measured values on the eye pattern display and jitter display in red
- Displays errors in the event log of the status display
- Displays “ERROR” in the upper right of the display.
- Transmits a signal from the alarm output remote terminal

[See also] 16.4.1, “Event Log Screen Description”

17.8.1 Configuring 12G Error Settings

Use the 12G-SDI ERROR SETUP tab to configure error detection settings for 12G signals. You can set the threshold values when you set the error detection to ON. Measured values given in SMPTE ST 2082-1 are used as 100 %.

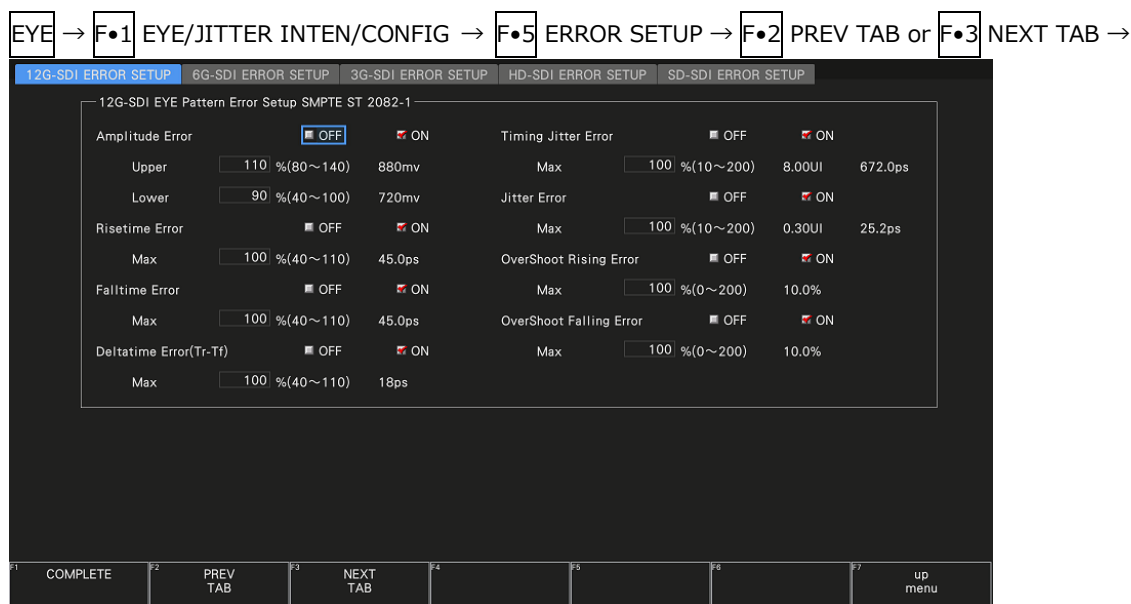

Figure 17-10 12G-SDI ERROR SETUP tab

A configuration example showing threshold values that correspond to SMPTE ST 2082-1 is given below.

Table 17-3 12G-SDI ERROR SETUP configuration example

Parameter		Setting Example	Corresponding Value
Amplitude Error	Upper	110%	880 mV
	Lower	90%	720 mV
Risetime Error	Max	100%	45.0 ps
Falltime Error	Max	100%	45.0 ps
Deltatime Error(Tr-Tf)	Max	100%	18 ps
Timing Jitter Error	Max	100%	8.00 UI (672.0 ps)
Jitter Error	Max	100%	0.30 UI (25.2 ps)
Overshoot Rising Error	Max	100%	10.0%
Overshoot Falling Error	Max	100%	10.0%

17. EYE PATTERN DISPLAY (SER02/SER02A)

- Amplitude Error

Turns the eye pattern's amplitude error detection on and off.

You cannot set Lower to a value that is greater than Upper, even if the value is within the selectable range.

Upper: 80 - 110 - 140% (640 - 1120 mV)

Lower: 40 - 90 - 100% (320 - 800 mV)

- Risetime Error

Turns the eye pattern's rise time (the time for the signal to rise from 20 to 80 % of its amplitude) error detection on and off.

Max: 40 - 100 - 110% (18.0 - 49.5 ps)

- Falltime Error

Turns the eye pattern's fall time (the time for the signal to fall from 80 to 20 % of its amplitude) error detection on and off.

Max: 40 - 100 - 110% (18.0 - 49.5 ps)

- Deltatime Error(Tr-Tf)

Turns the eye pattern's time difference (between the rise and fall times) error detection on and off. When the measured values exceed the specified value, Tr and Tf are displayed in red.

Max: 40 - 100 - 110% (7 - 20 ps)

- Timing Jitter Error

Turns the eye pattern and jitter's timing jitter error detection on and off.

Max: 10 - 100 - 200% (0.80 - 16.00 UI, 67.2 - 1344.0 ps)

- Jitter Error

Turns jitter error detection for eye pattern and jitter.

Max: 10 - 100 - 200% (0.03 - 0.60 UI, 2.5 - 50.4 ps)

- Overshoot Rising Error

Turns the rising edge overshoot error detection on and off.

Max: 0 - 100 - 200% (0.0 - 20.0%)

- Overshoot Falling Error

Turns the falling edge overshoot error detection on and off.

Max: 0 - 100 - 200% (0.0 - 20.0%)

17. EYE PATTERN DISPLAY (SER02/SER02A)

17.8.2 Configuring 6G Error Settings

Use the 6G-SDI ERROR SETUP tab to configure error detection settings for 6G signals. You can set the threshold values when you set the error detection to ON. Measured values given in SMPTE ST 2082-1 are used as 100 %.

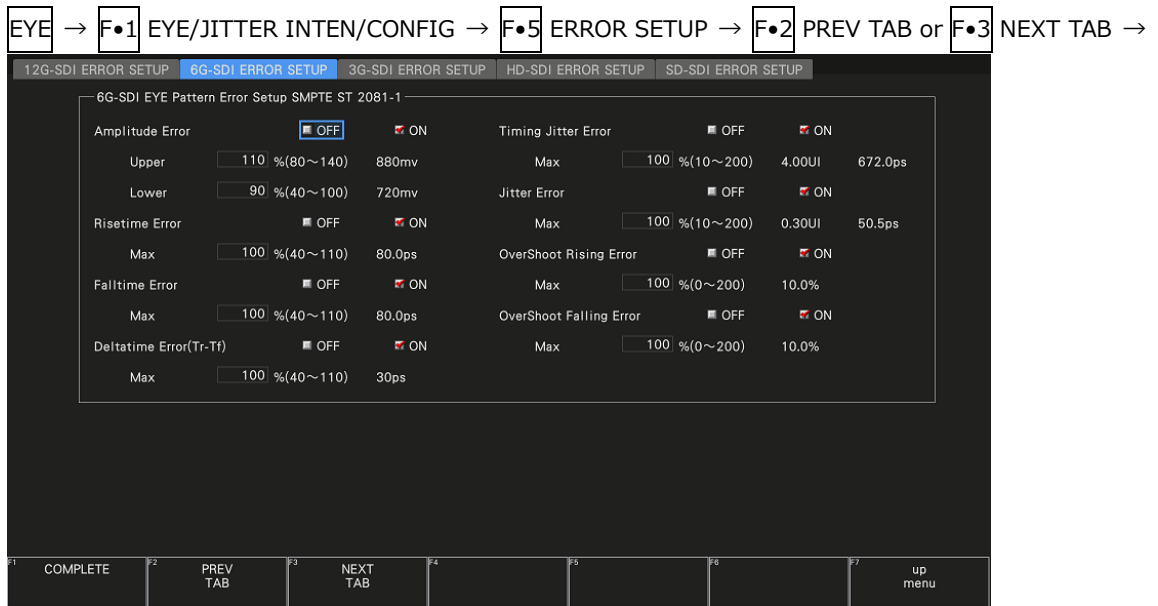

Figure 17-11 6G-SDI ERROR SETUP tab

A configuration example showing threshold values that correspond to SMPTE ST 2082-1 is given below.

Table 17-4 6G-SDI ERROR SETUP configuration example

Item		Setting Example	Corresponding Value
Amplitude Error	Upper	110%	880 mV
	Lower	90%	720 mV
Risetime Error	Max	100%	80.0 ps
Falltime Error	Max	100%	80.0 ps
Deltatime Error(Tr-Tf)	Max	100%	30 ps
Timing Jitter Error	Max	100%	4.00 UI (672.0ps)
Jitter Error	Max	100%	0.30 UI (50.5ps)
Overshoot Rising Error	Max	100%	10.0%
Overshoot Falling Error	Max	100%	10.0%

17. EYE PATTERN DISPLAY (SER02/SER02A)

- Amplitude Error

Turns the eye pattern's amplitude error detection on and off.

You cannot set Lower to a value that is greater than Upper, even if the value is within the selectable range.

Upper:	80 - <u>110</u> - 140% (640 - 1120 mV)
Lower:	40 - <u>90</u> - 100% (320 - 800 mV)

- Risetime Error

Turns the eye pattern's rise time (the time for the signal to rise from 20 to 80 % of its amplitude) error detection on and off.

Max:	40 - <u>100</u> - 110% (32.0 - 88.0 ps)
------	---

- Falltime Error

Turns the eye pattern's fall time (the time for the signal to fall from 80 to 20 % of its amplitude) error detection on and off.

Max:	40 - <u>100</u> - 110% (32.0 - 88.0 ps)
------	---

- Deltatime Error(Tr-Tf)

Turns the eye pattern's time difference (between the rise and fall times) error detection on and off. When the measured values exceed the specified value, Tr and Tf are displayed in red.

Max:	40 - <u>100</u> - 110% (12 - 33 ps)
------	-------------------------------------

- Timing Jitter Error

Turns the eye pattern and jitter's timing jitter error detection on and off.

Max:	10 - <u>100</u> - 200% (0.40 - 8.00 UI, 67.2 - 1344.0 ps)
------	---

- Jitter Error

Turns jitter error detection for eye pattern and jitter.

Max:	10 - <u>100</u> - 200% (0.03 - 0.60 UI, 5.0 - 100.9 ps)
------	---

- Overshoot Rising Error

Turns the rising edge overshoot error detection on and off.

Max:	0 - <u>100</u> - 200% (0.0 - 20.0%)
------	-------------------------------------

- Overshoot Falling Error

Turns the falling edge overshoot error detection on and off.

Max:	0 - <u>100</u> - 200% (0.0 - 20.0%)
------	-------------------------------------

17. EYE PATTERN DISPLAY (SER02/SER02A)

17.8.3 Configuring 3G Error Settings

Use the 3G-SDI ERROR SETUP tab to configure error detection settings for 3G signals. You can set the threshold values when you set the error detection to ON. Measured values given in SMPTE ST 424 are used as 100 %.

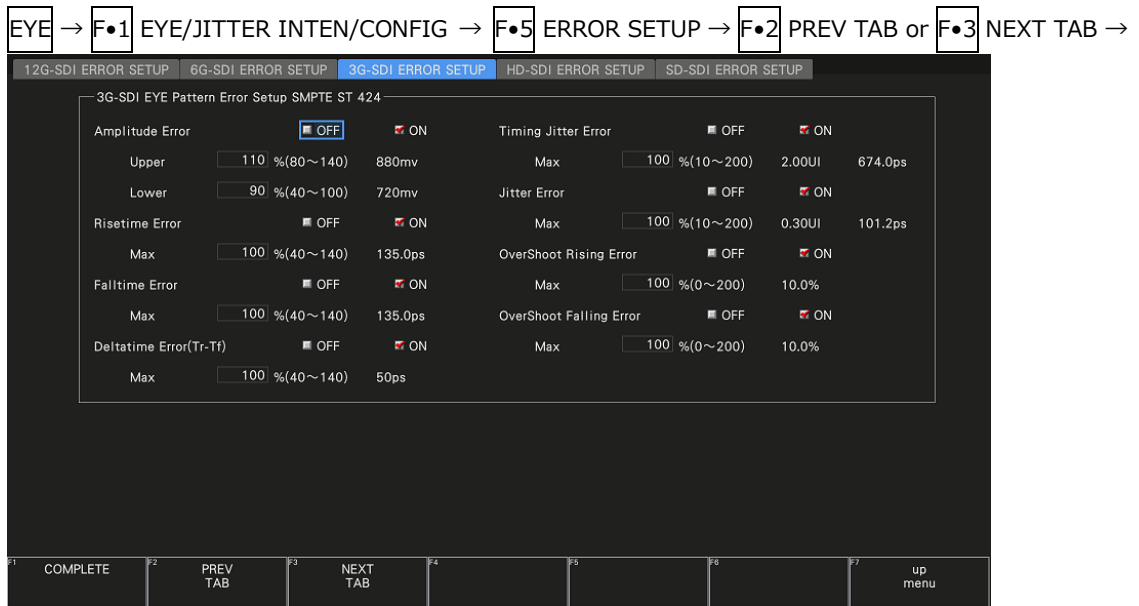

Figure 17-12 3G-SDI ERROR SETUP tab

A configuration example showing threshold values that correspond to SMPTE ST 424 is given below.

Table 17-5 3G-SDI ERROR SETUP configuration example

Parameter		Setting Example	Corresponding Value
Amplitude Error	Upper	110%	880 mV
	Lower	90%	720 mV
Risetime Error	Max	100%	135.0 ps
Falltime Error	Max	100%	135.0 ps
Deltatime Error(Tr-Tf)	Max	100%	50 ps
Timing Jitter Error	Max	100%	2.00 UI (674.0 ps)
Jitter Error	Max	100%	0.30 UI (101.2 ps)
Overshoot Rising Error	Max	100%	10.0%
Overshoot Falling Error	Max	100%	10.0%

17. EYE PATTERN DISPLAY (SER02/SER02A)

- Amplitude Error

Turns the eye pattern's amplitude error detection on and off.

You cannot set Lower to a value that is greater than Upper, even if the value is within the selectable range.

Upper: 80 - 110 - 140% (640 - 1120 mV)

Lower: 40 - 90 - 100% (320 - 800 mV)

- Risetime Error

Turns the eye pattern's rise time (the time for the signal to rise from 20 to 80 % of its amplitude) error detection on and off.

Max: 40 - 100 - 140% (54.0 - 189.0 ps)

- Falltime Error

Turns the eye pattern's fall time (the time for the signal to fall from 80 to 20 % of its amplitude) error detection on and off.

Max: 40 - 100 - 140% (54.0 - 189.0 ps)

- Deltatime Error(Tr-Tf)

Turns the eye pattern's time difference (between the rise and fall times) error detection on and off. When the measured values exceed the specified value, Tr and Tf are displayed in red.

Max: 40 - 100 - 140% (20 - 70 ps)

- Timing Jitter Error

Turns the eye pattern and jitter's timing jitter error detection on and off.

Max: 10 - 100 - 200% (0.20 - 4.00 UI, 67.4 - 1348.0 ps)

- Jitter Error

Turns jitter error detection for eye pattern and jitter.

Max: 10 - 100 - 200% (0.03 - 0.60 UI, 10.1 - 202.5 ps)

- Overshoot Rising Error

Turns the rising edge overshoot error detection on and off.

Max: 0 - 100 - 200% (0.0 - 20.0%)

- Overshoot Falling Error

Turns the falling edge overshoot error detection on and off.

Max: 0 - 100 - 200% (0.0 - 20.0%)

17. EYE PATTERN DISPLAY (SER02/SER02A)

17.8.4 Configuring HD Error Settings

Use the HD-SDI ERROR SETUP tab to configure error detection settings for HD signals. You can set the threshold values when you set the error detection to ON. Measured values given in SMPTE ST 292 are used as 100 %.

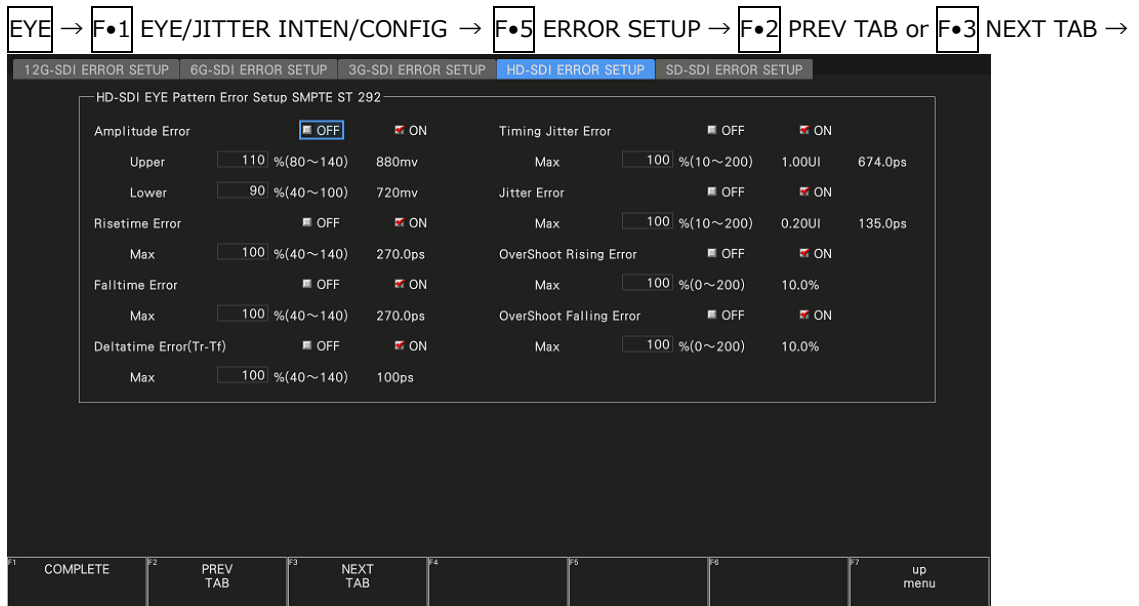

Figure 17-13 HD-SDI ERROR SETUP tab

A configuration example showing threshold values that correspond to SMPTE ST 292 is given below.

Table 17-6 HD-SDI ERROR SETUP configuration example

Parameter		Setting Example	Corresponding Value
Amplitude Error	Upper	110%	880 mV
	Lower	90%	720 mV
Risetime Error	Max	100%	270.0 ps
Falltime Error	Max	100%	270.0 ps
Deltatime Error(Tr-Tf)	Max	100%	100 ps
Timing Jitter Error	Max	100%	1.00 UI (674.0 ps)
Jitter Error	Max	100%	0.20 UI (135.0 ps)
Overshoot Rising Error	Max	100%	10.0%
Overshoot Falling Error	Max	100%	10.0%

17. EYE PATTERN DISPLAY (SER02/SER02A)

- Amplitude Error

Turns the eye pattern's amplitude error detection on and off.

You cannot set Lower to a value that is greater than Upper, even if the value is within the selectable range.

Upper: 80 - 110 - 140% (640 - 1120 mV)

Lower: 40 - 90 - 100% (320 - 800 mV)

- Risetime Error

Turns the eye pattern's rise time (the time for the signal to rise from 20 to 80 % of its amplitude) error detection on and off.

Max: 40 - 100 - 140% (108.0 - 378.0 ps)

- Falltime Error

Turns the eye pattern's fall time (the time for the signal to fall from 80 to 20 % of its amplitude) error detection on and off.

Max: 40 - 100 - 140% (108.0 - 378.0 ps)

- Deltatime Error(Tr-Tf)

Turns the eye pattern's time difference (between the rise and fall times) error detection on and off. When the measured values exceed the specified value, Tr and Tf are displayed in red.

Max: 40 - 100 - 140% (40 - 140 ps)

- Timing Jitter Error

Turns the eye pattern and jitter's timing jitter error detection on and off.

Max: 10 - 100 - 200% (0.10 - 2.00 UI, 67.4 - 1348.0 ps)

- Jitter Error

Turns jitter error detection for eye pattern and jitter.

Max: 10 - 100 - 200% (0.02 - 0.40 UI, 13.5 - 270.0 ps)

- Overshoot Rising Error

Turns the rising edge overshoot error detection on and off.

Max: 0 - 100 - 200% (0.0 - 20.0%)

- Overshoot Falling Error

Turns the falling edge overshoot error detection on and off.

Max: 0 - 100 - 200% (0.0 - 20.0%)

17. EYE PATTERN DISPLAY (SER02/SER02A)

17.8.5 Configuring SD Error Settings

Use the SD-SDI ERROR SETUP tab to configure error detection settings for SD signals. You can set the threshold values when you set the error detection to ON. Measured values given in SMPTE ST 259 are used as 100 %.

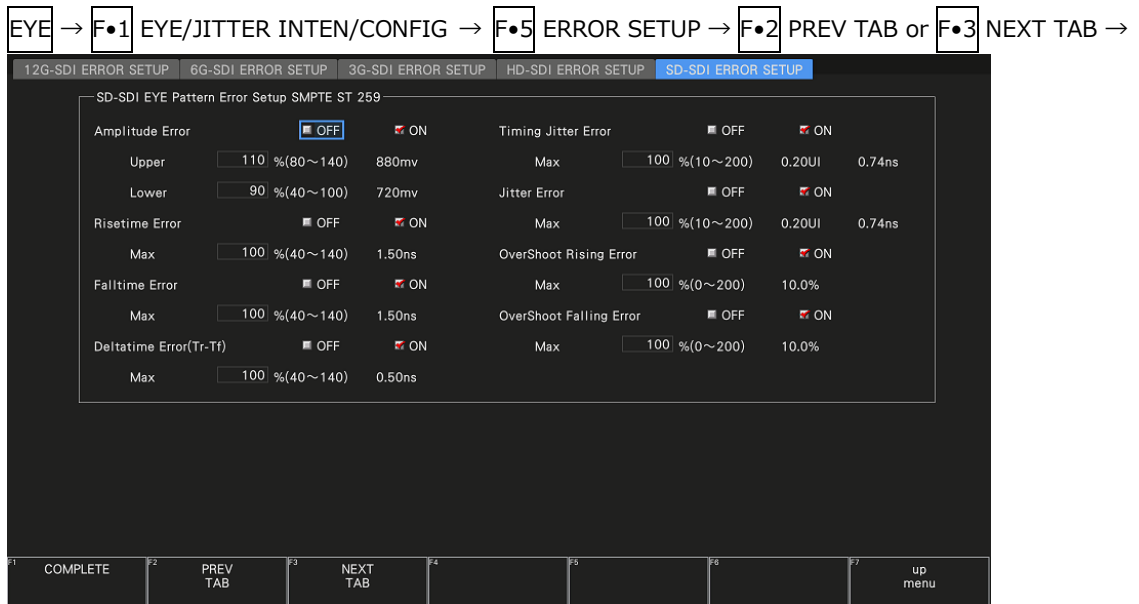

Figure 17-14 SD-SDI ERROR SETUP tab

A configuration example showing threshold values that correspond to SMPTE ST 259 is given below.

Table 17-7 SD-SDI ERROR SETUP configuration example

Parameter		Setting Example	Corresponding Value
Amplitude Error	Upper	110%	880 mV
	Lower	90%	720 mV
Risetime Error	Max	100%	1.50 ns
Falltime Error	Max	100%	1.50 ns
Deltatime Error(Tr-Tf)	Max	100%	0.50 ns
Timing Jitter Error	Max	100%	0.20 UI (0.74 ns)
Jitter Error	Max	100%	0.20 UI (0.74 ns)
Overshoot Rising Error	Max	100%	10.0%
Overshoot Falling Error	Max	100%	10.0%

17. EYE PATTERN DISPLAY (SER02/SER02A)

- Amplitude Error

Turns the eye pattern's amplitude error detection on and off.

You cannot set Lower to a value that is greater than Upper, even if the value is within the selectable range.

Upper: 80 - 110 - 140% (640 - 1120 mV)

Lower: 40 - 90 - 100% (320 - 800 mV)

- Risetime Error

Turns the eye pattern's rise time (the time for the signal to rise from 20 to 80 % of its amplitude) error detection on and off.

Max: 40 - 100 - 140% (0.60 - 2.10 ns)

- Falltime Error

Turns the eye pattern's fall time (the time for the signal to fall from 80 to 20 % of its amplitude) error detection on and off.

Max: 40 - 100 - 140% (0.60 - 2.10 ns)

- Deltatime Error(Tr-Tf)

Turns the eye pattern's time difference (between the rise and fall times) error detection on and off. When the measured values exceed the specified value, Tr and Tf are displayed in red.

Max: 40 - 100 - 140% (0.20 - 0.70 ns)

- Timing Jitter Error

Turns the eye pattern and jitter's timing jitter error detection on and off.

Max: 10 - 100 - 200% (0.02 - 0.40 UI, 0.07 - 1.48 ns)

- Jitter Error

Turns jitter error detection for eye pattern and jitter.

Max: 10 - 100 - 200% (0.02 - 0.40 UI, 0.07 - 1.48 ns)

- Overshoot Rising Error

Turns the rising edge overshoot error detection on and off.

Max: 0 - 100 - 200% (0.0 - 20.0%)

- Overshoot Falling Error

Turns the falling edge overshoot error detection on and off.

Max: 0 - 100 - 200% (0.0 - 20.0%)

17.9 Configuring Eye Pattern Display Settings

To configure eye pattern display settings, press **F•2** GAIN/FILTER/SWEEP on the EYE menu. This menu appears when **F•1** EYE/JITTER INTEN/CONFIG → **F•1** EYE/JITTER MODE is set to EYE.

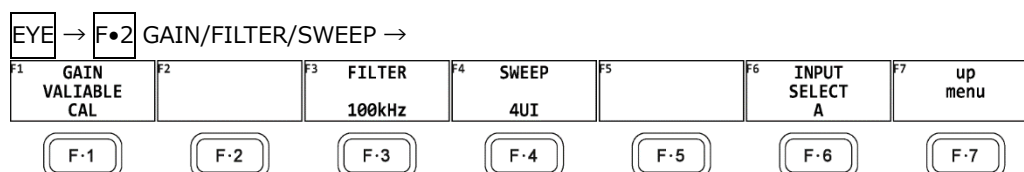

Figure 17-15 GAIN/FILTER/SWEEP menu

17.9.1 Adjusting the Gain

To adjust the eye-pattern gain, follow the procedure below.

Procedure

EYE → **F•2** GAIN/FILTER/SWEEP → **F•1** GAIN VARIABLE: CAL / VARIABLE

Settings

CAL: The eye pattern is shown without gain.
VARIABLE: The eye pattern is shown with the specified gain (×0.50 to ×2.00). The gain value appears in the upper right of the screen.
 Turn the function dial (F•D) to adjust the gain. Press the function dial (F•D) to return the setting to its default value (1.00).

17.9.2 Selecting the Filter

To select the filter that is used during jitter measurement, follow the procedure below. The selected filter is indicated at the bottom of the display.

If you change this setting, the filter that you selected for jitter display also changes.

[See also] 17.10.2, "Selecting the Filter"

Procedure

EYE → **F•2** GAIN/FILTER/SWEEP → **F•3** FILTER: 100kHz / 1kHz / 100Hz / 10Hz / TIMING / ALIGNMENT

Settings

100kHz: Jitter at 100 kHz or higher is measured.
1kHz: Jitter at 1 kHz or higher is measured.
100Hz: Jitter at 100 Hz or higher is measured.
10Hz: Jitter at 10 Hz or higher is measured.
TIMING: Timing jitter is measured. Jitter at 10 Hz or higher is measured.
ALIGNMENT: Alignment jitter is measured. When the input signal is not SD, jitter at 100 kHz and higher is measured. When the input signal is SD, jitter at 1 kHz and higher is measured.

17. EYE PATTERN DISPLAY (SER02/SER02A)

17.9.3 Selecting the Sweep Time

To select the eye pattern sweep time, follow the procedure below.

Procedure

EYE	→	F•2	GAIN/FILTER/SWEEP	→	F•4	SWEEP: 2UI / <u>4UI</u> / 16UI
-----	---	-----	-------------------	---	-----	--------------------------------

Settings

2UI:	Two cycles of the eye pattern are shown.
4UI:	Four cycles of the eye pattern are shown.
16UI:	Sixteen cycles of the eye pattern are shown.

SWEEP = 2UI

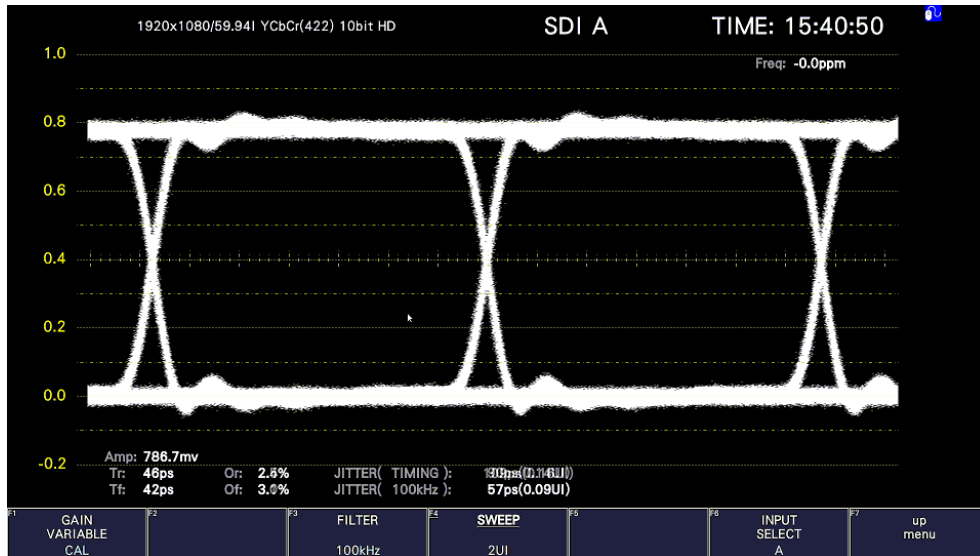

SWEEP = 16UI

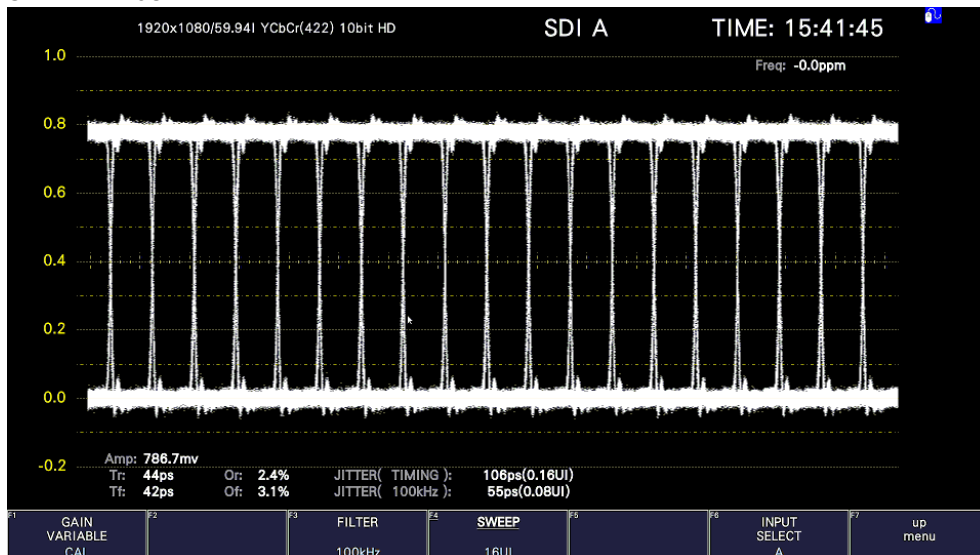

Figure 17-16 Selecting the sweep time

17. EYE PATTERN DISPLAY (SER02/SER02A)

17.9.4 Turning the Peak Hold On and Off

To configure the peak hold settings, press **F•3** PEAK HOLD on the EYE menu. Measurement is possible regardless of whether **F•1** EYE/JITTER INTEN/CONFIG → **F•2** EYE/JITTER is set to EYE or JITTER.

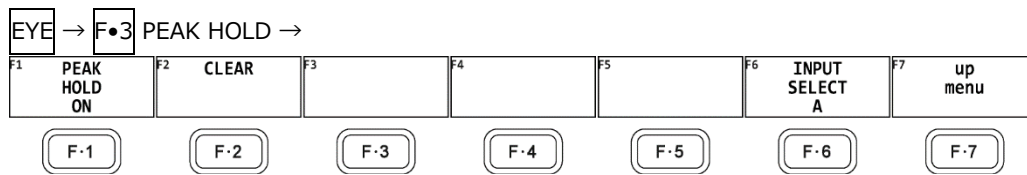

Figure 17-17 PEAK HOLD menu

To measure the peak values of the timing jitter (T.J) and the jitter (JIT), follow the procedure below.

When you set **F•1** PEAK HOLD to ON, the peak values T.J.PEAK and J.PEAK are displayed in the lower part of the screen next to "PEAK."

The peak values are retained until you press **F•2** CLEAR. If a peak value exceeds 10.00UI, "OVER" is displayed.

Procedure

EYE → **F•3** PEAK HOLD → **F•1** PEAK HOLD: ON / OFF

PEAK HOLD = ON

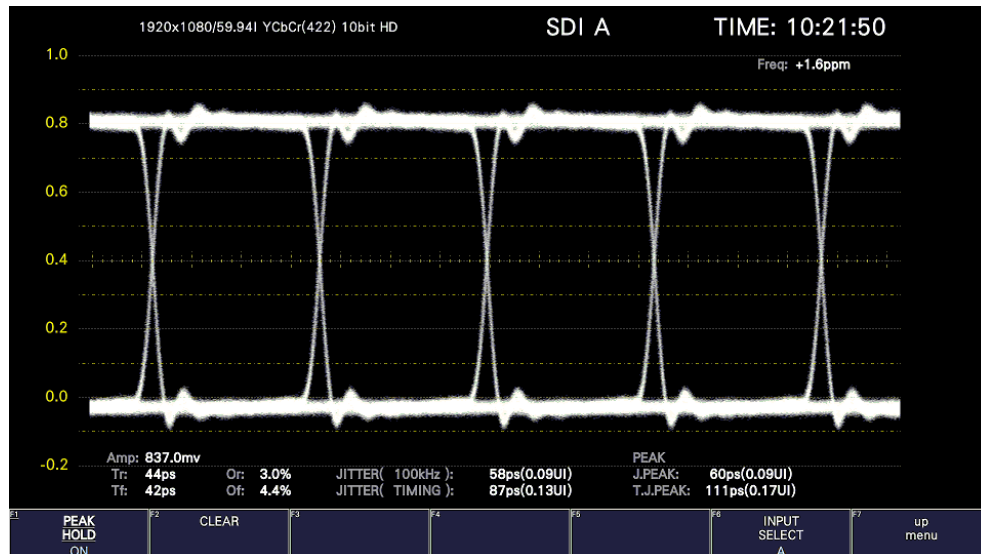

Figure 17-18 Peak hold display

17.9.5 Clearing the Peak Hold

When **F•1** PEAK HOLD is set to ON, to clear the peak hold, follow the procedure below.

Procedure

EYE → **F•3** PEAK HOLD → **F•2** CLEAR

17. EYE PATTERN DISPLAY (SER02/SER02A)

17.9.6 Turning Cursors On and Off

To configure the cursor settings, press **F•4** CURSOR on the EYE menu.

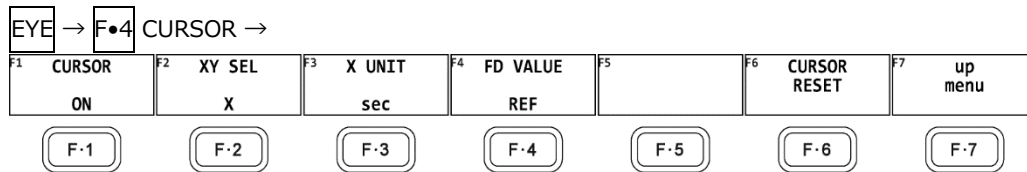

Figure 17-19 CURSOR menu

To turn cursors on and off, follow the procedure shown below.

When the cursors are turned on, the REF cursors are displayed in yellow (X) and light blue (Y), and the DELTA cursors are displayed in purple (X) and green (Y). The values of DELTA-REF appear as measured values in the upper part of the screen.

Procedure

EYE → **F•4** CURSOR → **F•1** CURSOR: ON / OFF

CURSOR = ON

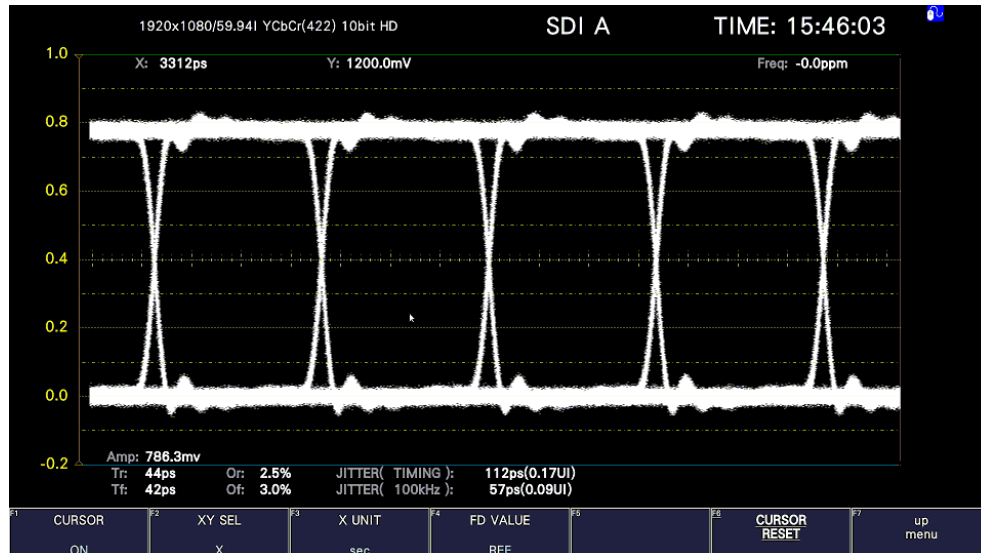

Figure 17-20 Cursor display

17. EYE PATTERN DISPLAY (SER02/SER02A)

17.9.7 Selecting the Cursor

The X-axis and Y-axis cursors are displayed at the same time, but you can only use the function dial (F•D) to move one set of cursors at a time. To select which cursors you want to move, follow the procedure below.

Procedure

EYE	→	F•4	CURSOR	→	F•2	XY SEL: X / Y / Tr,Tf
-----	---	-----	--------	---	-----	-----------------------

If you select Tr,Tf, you can measure the rise time (Tr) and fall time (Tf). Follow the procedure below.

1. Set **F•2** XY SEL to Tr,Tf.
This selects the Y-axis cursors.
2. Use the function dial (F•D) to align the cursors with the amplitude of the eye pattern.
This is the 100% amplitude position.

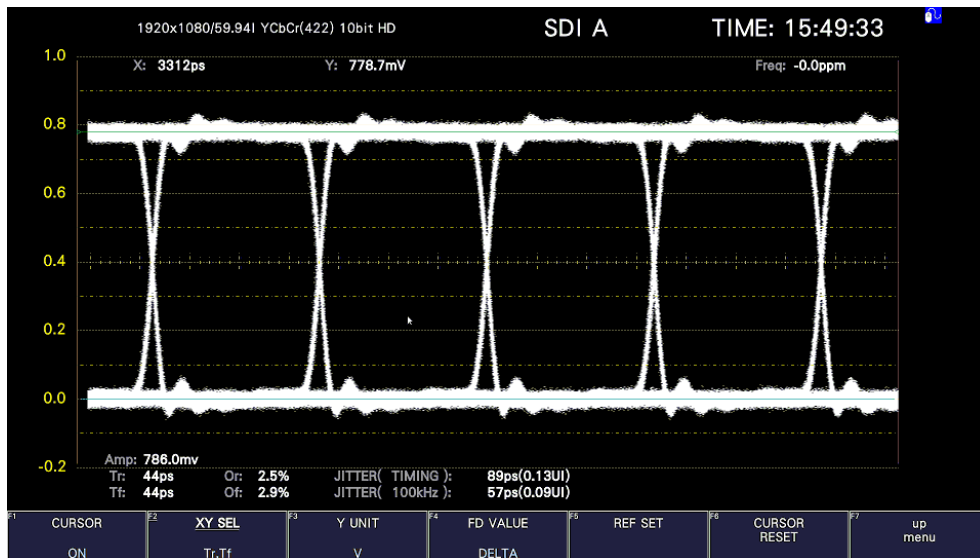

Figure 17-21 Tr,Tf measurement (1)

17. EYE PATTERN DISPLAY (SER02/SER02A)

- Press **F•5** REF SET.

The Y-axis cursors move to the 20 % and 80 % positions of the amplitude, and then **F•2** XY SEL is automatically set to X.

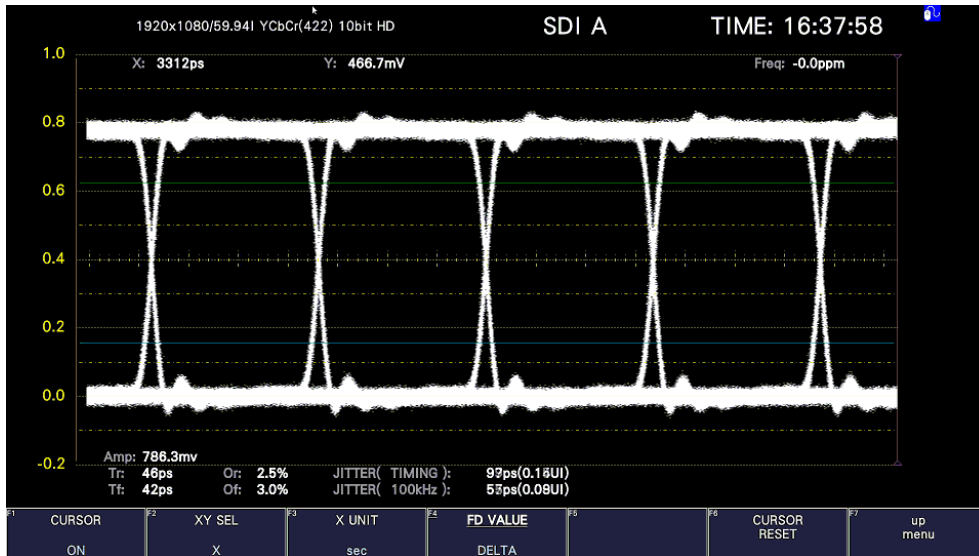

Figure 17-22 Tr,Tf measurement (2)

- Align the X-axis cursors with the intersections of the Y-axis cursors and the eye pattern. Align with the rising edge of the pattern to measure Tr and the falling edge to measure Tf.

The measured value is displayed next to X in the upper part of the screen.

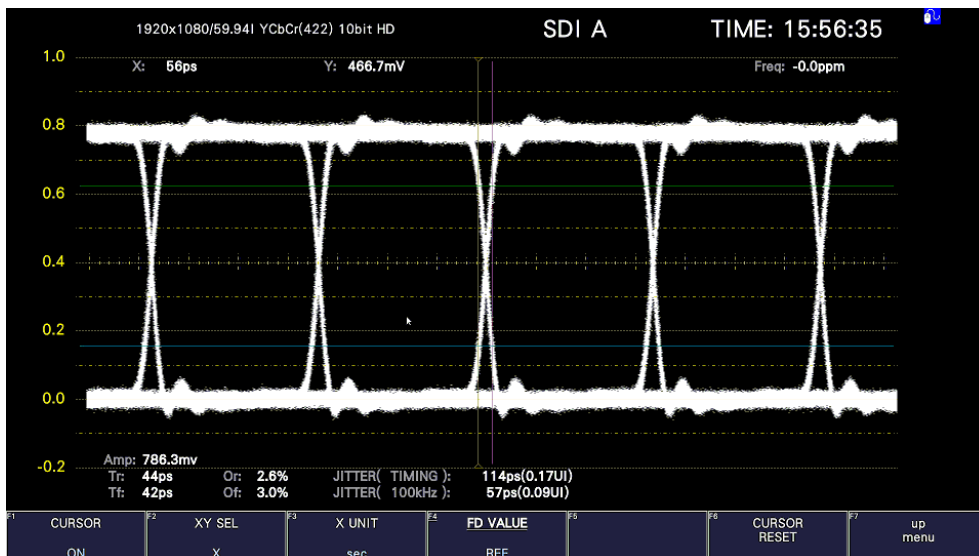

Figure 17-23 Tr, Tf measurement 3 (example of Tr)

17.9.8 Selecting the X-Axis Measurement Unit

When **F•2** XY SEL is set to X, to select the X-axis cursor measurement unit, follow the procedure below.

Procedure

EYE	→	F•4	CURSOR	→	F•3	X UNIT: <u>sec</u> / Hz / UIp-p
-----	---	-----	--------	---	-----	---------------------------------

Settings

sec:	The measurement unit is seconds.
Hz:	The measurement unit is frequency, with the length of one period set to the distance between the two cursors.
UIp-p:	The measurement unit is UIp-p, with one UIp-p set to one cycle of the eye pattern.

17.9.9 Selecting the Y-Axis Measurement Unit

When **F•2** XY SEL is set to Y, to select the Y-axis cursor measurement unit, follow the procedure below.

Procedure

EYE	→	F•4	CURSOR	→	F•3	Y UNIT: <u>V</u> / %
-----	---	-----	--------	---	-----	----------------------

Settings

V:	The measurement unit is volts.
%:	The amplitude will be measured as a percentage of the amplitude at the time when you pressed F•5 REF SET.

17.9.10 Moving the Cursors

To move a cursor, follow the procedure shown below to select a cursor. Then, move the cursor by turning the function dial (F•D). Triangles appear on both ends of the selected cursor.

You can also select a cursor by pressing the function dial (F•D). Each time you press the function dial (F•D), the selected cursor switches from REF, to DELTA, to TRACK, and then back to REF.

Procedure

EYE	→	F•4	CURSOR	→	F•4	FD VALUE: <u>REF</u> / DELTA / TRACK
-----	---	-----	--------	---	-----	--------------------------------------

Settings

REF:	The REF cursor (yellow or light blue) is selected.
DELTA:	The DELTA cursor (purple or green) is selected.
TRACK:	The REF cursor and DELTA cursor are both selected.

17. EYE PATTERN DISPLAY (SER02/SER02A)

17.9.11 Resetting Cursors

To reset the cursor positions, follow the procedure below.

Procedure

EYE	→	F•4	CURSOR	→	F•6	CURSOR RESET
-----	---	-----	--------	---	-----	--------------

17.9.12 Selecting the Display Mode

To select the eye pattern display mode, follow the procedure below.

If the eye pattern and jitter are displayed simultaneously, the setting specified here also applies to the jitter.

Procedure

EYE	→	F•5	TRIGGER: <u>RUN</u> / STOP
-----	---	-----	----------------------------

Settings

RUN: The input signal is automatically updated and displayed.

STOP: The input signal is displayed statically. This is convenient for cursor measurement.

Even if STOP is selected, if you change the measurement conditions, such as switching to jitter, the mode switches to RUN.

17.9.13 Selecting the 2-Screen Display Mode

To select the eye pattern's 2-screen display mode, follow the procedure below.

Procedure

EYE	→	F•7	DISPLAY MODE: <u>SINGLE</u> / DUAL
-----	---	-----	------------------------------------

Settings

SINGLE: Displays the eye pattern of the selected filter in a single screen

DUAL: Displays the timing filter and eye pattern of the selected filter in two screens

17.10 Configuring the Jitter Display Settings

To configure the jitter display settings, press **F•1** EYE/JITTER INTEN/CONFIG on the EYE menu.

This menu appears when **F•1** EYE/JITTER INTEN/CONFIG → **F•1** EYE/JITTER MODE is set to JITTER.

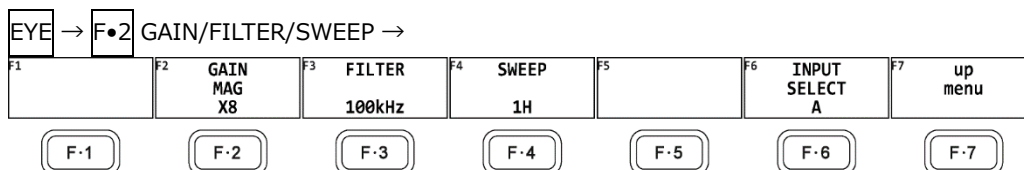

Figure 17-24 GAIN/FILTER/SWEEP menu

17. EYE PATTERN DISPLAY (SER02/SER02A)

17.10.1 Selecting the Magnification

To select the jitter display magnification, follow the procedure below.

Procedure

EYE → **F•2** GAIN/FILTER/SWEEP → **F•2** GAIN MAG

: X1 / X2 / X8 (for formats other than 12G)

: X1 / X2 / X4 / X16 (for 12G)

17.10.2 Selecting the Filter

To select the filter that is used during jitter measurement, follow the procedure below. The selected filter is indicated at the bottom of the display.

If you change this setting, the filter that you selected for the eye pattern display also changes.

[See also] 17.9.2, "Selecting the Filter"

Procedure

EYE → **F•2** GAIN/FILTER/SWEEP → **F•3** FILTER: 100kHz / 1kHz / 100Hz / 10Hz / TIMING / ALIGNMENT

17.10.3 Selecting the Sweep Time

To select the sweep time, follow the procedure below.

Procedure

EYE → **F•2** GAIN/FILTER/SWEEP → **F•4** SWEEP: 1H / 2H / 1V / 2V

Settings

1H: The jitter from a period of one line is shown.

2H: The jitter from a period of two lines is shown.

1V: When the input signal is interlace or segmented frame, the jitter from a period of one field is shown. When the input signal is progressive, the jitter from a period of one frame is shown.

2V: When the input signal is interlace or segmented frame, the jitter from a period of one frame is shown. When the input signal is progressive, the jitter from a period of two frames is shown.

This option cannot be selected when the input signal is progressive except for 60/59.94/50P of HD(DL).

17. EYE PATTERN DISPLAY (SER02/SER02A)

17.10.4 Turning the Peak Hold On and Off

To configure the peak hold settings, press **F•3** PEAK HOLD on the EYE menu.

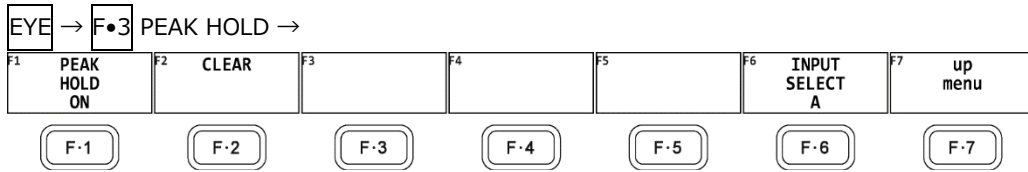

Figure 17-25 PEAK HOLD menu

To measure the peak values of the timing jitter (T.J) and the jitter (JIT), follow the procedure below.

When you set **F•1** PEAK HOLD to ON, the peak values T.J.PEAK and J.PEAK are displayed in the lower part of the screen next to "PEAK."

The peak values are retained until you press **F•2** CLEAR. If a peak value exceeds 10.00UI, "OVER" is displayed.

Procedure

EYE → **F•4** PEAK HOLD → **F•1** PEAK HOLD: ON / OFF

PEAK HOLD = ON

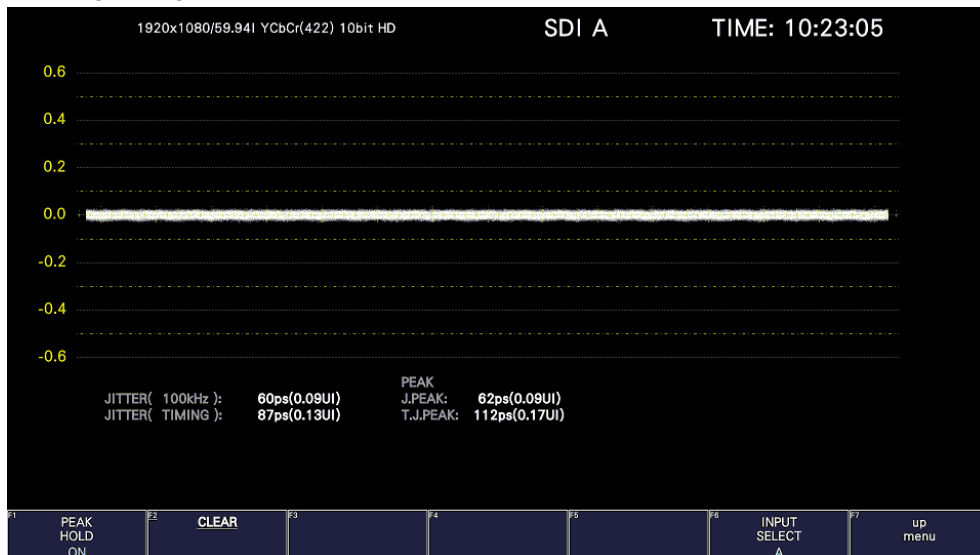

Figure 17-26 Peak hold display

17.10.5 Clearing the Peak Hold

When **F•1** PEAK HOLD is set to ON, to clear the peak hold, follow the procedure below.

Procedure

EYE → **F•4** PEAK HOLD → **F•2** CLEAR

17. EYE PATTERN DISPLAY (SER02/SER02A)

17.10.6 Turning Cursors On and Off

To configure the cursor settings, press **F•4** CURSOR on the EYE menu.

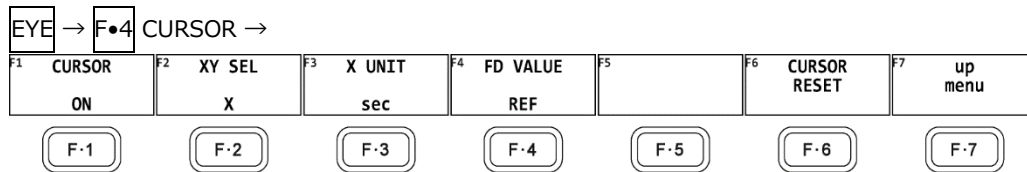

Figure 17-27 CURSOR menu

To turn cursors on and off, follow the procedure shown below.

When the cursors are turned on, the REF cursors are displayed in yellow (X) and light blue (Y), and the DELTA cursors are displayed in purple (X) and green (Y). The values of DELTA-REF appear as measured values in the upper part of the screen.

Procedure

EYE → **F•3** CURSOR → **F•1** CURSOR: ON / OFF

CURSOR = ON

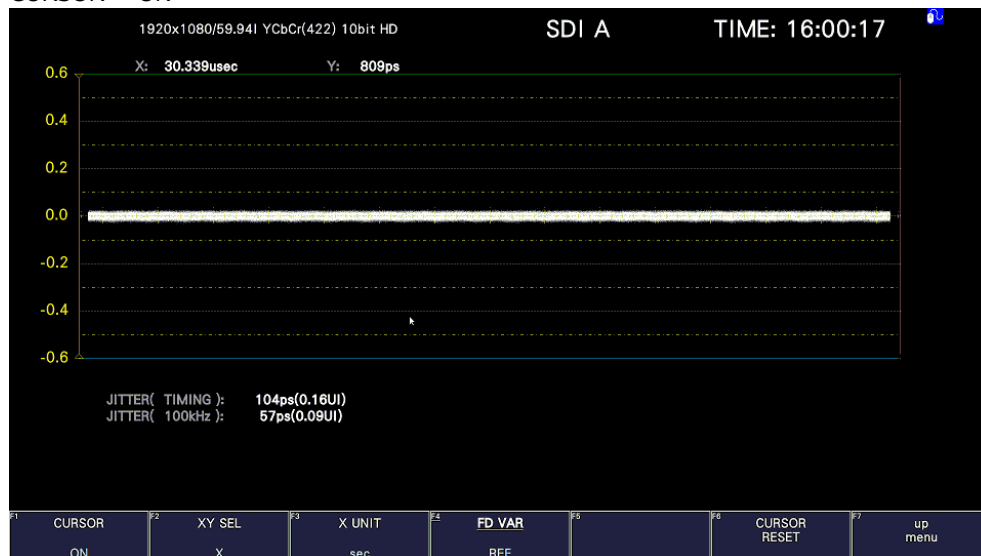

Figure 17-28 Cursor display

17.10.7 Selecting the Cursor

The X-axis and Y-axis cursors are displayed at the same time, but you can only use the function dial (F•D) to move one set of cursors at a time. To select which cursors you want to move, follow the procedure below.

Procedure

EYE → **F•4** CURSOR → **F•2** XY SEL: X / Y

17. EYE PATTERN DISPLAY (SER02/SER02A)

17.10.8 Selecting the X-Axis Measurement Unit

When **F•2** XY SEL is set to X, to select the X-axis cursor measurement unit, follow the procedure below.

Procedure

EYE	→	F•4	CURSOR	→	F•3	X UNIT: <u>sec</u> / Hz
-----	---	-----	--------	---	-----	-------------------------

Settings

sec:	The measurement unit is seconds.
Hz:	The measurement unit is frequency, with the length of one period set to the distance between the two cursors.

17.10.9 Selecting the Y-Axis Measurement Unit

When **F•2** XY SEL is set to Y, to select the Y-axis cursor measurement unit, follow the procedure below.

Procedure

EYE	→	F•4	CURSOR	→	F•3	Y UNIT: <u>sec</u> / UIp-p
-----	---	-----	--------	---	-----	----------------------------

Settings

sec:	The measurement unit is seconds.
UIp-p:	The measurement unit is UIp-p, with one UIp-p set to one cycle of the eye pattern.

17.10.10 Moving the Cursors

To move a cursor, follow the procedure shown below to select a cursor. Then, move the cursor by turning the function dial (F•D). Triangles appear on both ends of the selected cursor.

You can also select a cursor by pressing the function dial (F•D). Each time you press the function dial (F•D), the selected cursor switches from REF, to DELTA, to TRACK, and then back to REF.

Procedure

EYE	→	F•4	CURSOR	→	F•4	FD VAR: <u>REF</u> / DELTA / TRACK
-----	---	-----	--------	---	-----	------------------------------------

Settings

REF:	The REF cursor (yellow or light blue) is selected.
DELTA:	The DELTA cursor (purple or green) is selected.
TRACK:	The REF cursor and DELTA cursor are both selected.

17. EYE PATTERN DISPLAY (SER02/SER02A)

17.10.11 Resetting Cursors

To reset the cursor positions, follow the procedure below.

Procedure

EYE	→	F•4	CURSOR	→	F•6	CURSOR RESET
-----	---	-----	--------	---	-----	--------------

17.10.12 Selecting the Display Mode

To select the jitter display mode, follow the procedure below.

If the eye pattern and jitter are displayed simultaneously, the setting specified here also applies to the eye pattern.

Procedure

EYE	→	F•5	TRIGGER: <u>RUN</u> / STOP
-----	---	-----	----------------------------

Settings

RUN: The input signal is automatically updated and displayed.

STOP: The input signal is displayed statically. This is convenient for cursor measurement.

Even if STOP is selected, if you change the measurement conditions, such as switching to eye pattern, the mode switches to RUN.

17.10.13 Selecting the 2-Screen Display Mode

To select the jitter's 2-screen display mode, follow the procedure below.

Procedure

EYE	→	F•7	DISPLAY MODE: <u>SINGLE</u> / DUAL
-----	---	-----	------------------------------------

Settings

SINGLE: Displays the jitter waveform of the selected filter in a single screen

DUAL: Displays the timing jitter and the jitter waveform of the selected filter in two screens

18. REMOTE CONTROL

You can use the remote connector on the rear panel to load presets, transmit alarm signals, and perform other operations. Use your 15-pin D-sub connector to control the instrument.

- Remote Connector Diagram

The remote connector diagram as viewed from the rear panel is shown below.

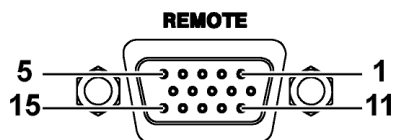

Figure 18-1 Remote connector (female, inch screws)

- Configuring the instrument

To configure the remote control connector, use the SYS menu. See section 7.2.8, “Setting the Remote Connector.”

To display tallies through the remote connector, an SER27 must be installed and Tally Control Select must be set to Remote.

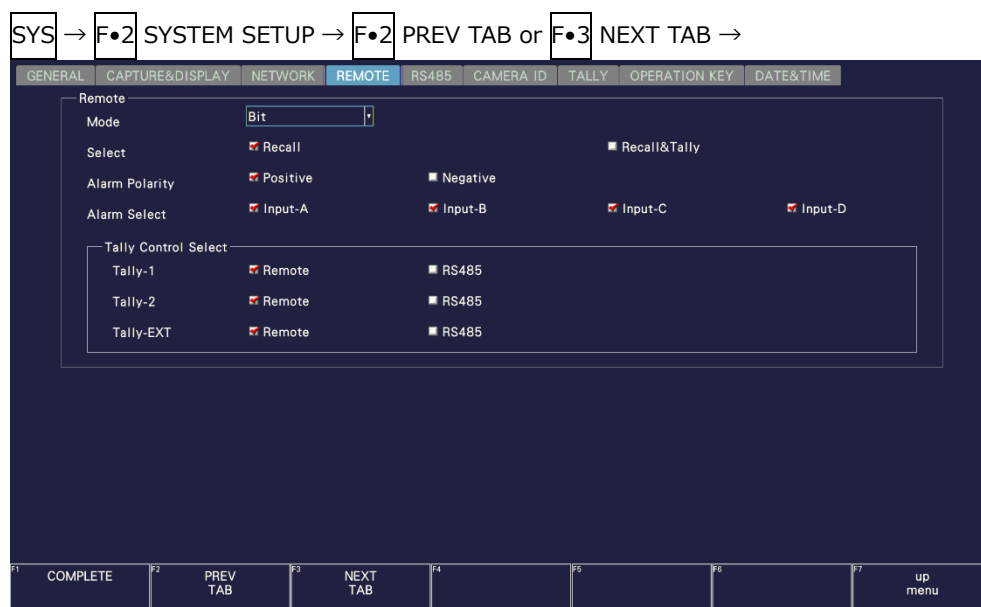

Figure 18-2 REMOTE tab

Each mode on the REMOTE tab is described below. Depending on the selected mode, the items that can be controlled vary as follows.

Table 18-1 Mode

	Bit	Binary	Command	Tally
Load presets	P	Y	Y	N
Switch the display channel	Y	Y	Y	N
Alarm output	Y	Y	Y	Y
Tally display (SER27)	P	N	P	Y
Loudness control (SER03)	Y	Y	N	N

(Y: supported; P: partially supported N: not supported)

18. REMOTE CONTROL

18.1 Bit Mode

This section describes the control method when Mode on the SYS menu is set to Bit.

- Pinout

Table 18-2 Pinout

Pin No.	Name	I/O (*1)	Description
1	OPEN	-	Open (*2)
2	/P1	I	Loads preset 1
3	/P2	I	Loads preset 2
4	/P3	I	Loads preset 3
5	/P4	I	Loads preset 4
6	/P5	I	Loads preset 5
7	/P6	I	Loads preset 6
8	/P7	I	Loads preset 7 / clears loudness measurement (SER03) (*3)
9	/P8	I	Loads preset 8 / starts/stops the loudness measurement (SER03) (*3)
10	/ACH	I	Selects Ach / Tally1 (*4)
11	/BCH	I	Selects Bch / Tally2 (*4)
12	/CCH	I	Selects Cch / Tally3 (*4)
13	/DCH	I	Selects Dch / Tally4 (*4)
14	ALARM	O	Alarm output
15	GND	-	Ground

*1 Is (inputs) are all pulled up to +3.3 V but can also receive +5 V.

*2 Do not connect anything.

*3 On the REMOTE tab of the SYS menu, when Select is set to Recall, preset recalling 7/8 is enabled. When it is set to Recall&Loudness, loudness measurement control is enabled.

*4 On the REMOTE tab of the SYS menu, when Select is set to Recall, the pins are for Input Select A to Dch. When Select is set to Recall&Tally, the pins are for Tally 1 to 4.

18. REMOTE CONTROL

- Control

The input connectors respond to active-low signals. Do not apply negative voltages or voltages that exceed +5 V. The active-low signal must be stable for at least 350 ms. After that, wait at least 1 second before applying the next signal.

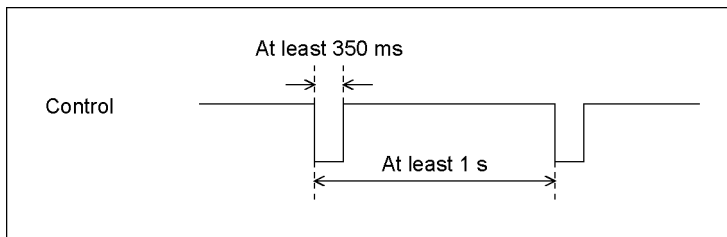

Figure 18-3 Control timing 1

After a setting is made, it may take about 3 seconds for the operation to finish. If you configure subsequent settings before the initial operation finishes, only the last setting will take effect. All settings in between will be discarded. (In the following example, control 2 will be discarded.)

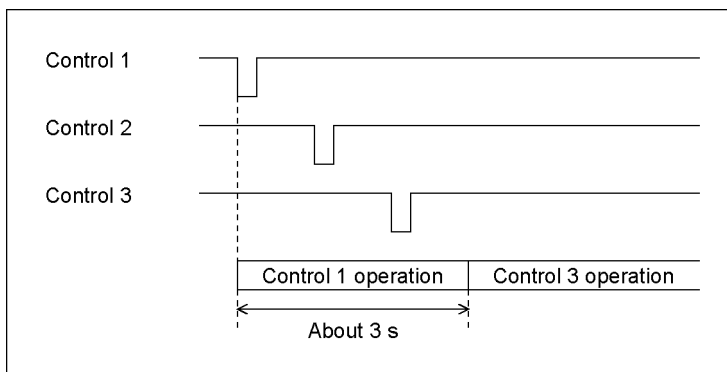

Figure 18-4 Control timing 2

- Recalling a Preset

You can use pins 2 to 9 of the remote connector to load presets.

In Bit mode, presets 1 to 8 can be recalled out of presets 1 to 60. Set the number to recall to low level.

- Switching Display Channels

You can use pins 10 to 13 of the remote connector to switch the display channel.

Channels that you set to low will be turned on, and channels that you set to high will be turned off. However, in single input mode, you cannot turn multiple channels on.

18. REMOTE CONTROL

- Alarm output

An alarm is transmitted from pin 14 of the remote connector in the following situations. The alarm output applies to all channels (A to D). However, when measuring 3G-B DS or 3G(DL)-4K, alarms are output only for the currently displayed channels.

- When a format other than that specified on the SDI IN SETUP2 tab of the SYS menu is received
 - When an error occurs in the item that you have set to ON using **F•5** STATUS SETUP on the STATUS menu
(except ERROR SETUP5 tab)
 - When a fan error occurs
 - When the internal temperature rises to an abnormal level
(When Temperature of **F•3** SYSTEM INFO on the SYS menu turns yellow)
- Loudness control measurement (SER03)

To control loudness measurement, set Select to Recall&Loudness, and use pins 8 and 9 of the remote connector.

[See also] 15.9.6, "Configuring Loudness Settings"

For preset operation, set both pins 8 and 9 to high.

When the loudness is stopped (8p: L 9p: L) once and the loudness is started (8p: L 9p: H), the loudness measurement is started.

Table 18-3 Loudness control

	9p (/P8)	8p (/P7)
Clears loudness measurement	L	H
Starts loudness measurement	H	L
Stops loudness measurement	L	L

18.2 Binary Mode

This section describes the control method when Mode on the SYS menu is set to Binary.

- Pinout
- Control
- Switching Display Channels
- Alarm output
- Loudness control measurement (SER03)

These are the same as Bit mode. See section 18.1, "Bit Mode."

- Recalling a Preset

You can use pins 2 to 7 of the remote connector to load presets.

Table 18-4 Loading presets

Preset No.	7p	6p	5p	4p	3p	2p
	/P6	/P5	/P4	/P3	/P2	/P1
1	H	H	H	H	H	L
2	H	H	H	H	L	H
3	H	H	H	H	L	L
4	H	H	H	L	H	H
5	H	H	H	L	H	L
6	H	H	H	L	L	H
7	H	H	H	L	L	L
8	H	H	L	H	H	H
9	H	H	L	H	H	L
10	H	H	L	H	L	H
11	H	H	L	H	L	L
12	H	H	L	L	H	H
13	H	H	L	L	H	L
14	H	H	L	L	L	H
15	H	H	L	L	L	L
16	H	L	H	H	H	H
17	H	L	H	H	H	L
18	H	L	H	H	L	H
19	H	L	H	H	L	L
20	H	L	H	L	H	H
21	H	L	H	L	H	L
22	H	L	H	L	L	H
23	H	L	H	L	L	L
24	H	L	L	H	H	H
25	H	L	L	H	H	L
26	H	L	L	H	L	H
27	H	L	L	H	L	L
28	H	L	L	L	H	H
29	H	L	L	L	H	L

18. REMOTE CONTROL

Preset No.	7p	6p	5p	4p	3p	2p
	/P6	/P5	/P4	/P3	/P2	/P1
30	H	L	L	L	L	H
31	H	L	L	L	L	L
32	L	H	H	H	H	H
33	L	H	H	H	H	L
34	L	H	H	H	L	H
35	L	H	H	H	L	L
36	L	H	H	L	H	H
37	L	H	H	L	H	L
38	L	H	H	L	L	H
39	L	H	H	L	L	L
40	L	H	L	H	H	H
41	L	H	L	H	H	L
42	L	H	L	H	L	H
43	L	H	L	H	L	L
44	L	H	L	L	H	H
45	L	H	L	L	H	L
46	L	H	L	L	L	H
47	L	H	L	L	L	L
48	L	L	H	H	H	H
49	L	L	H	H	H	L
50	L	L	H	H	L	H
51	L	L	H	H	L	L
52	L	L	H	L	H	H
53	L	L	H	L	H	L
54	L	L	H	L	L	H
55	L	L	H	L	L	L
56	L	L	L	H	H	H
57	L	L	L	H	H	L
58	L	L	L	H	L	H
59	L	L	L	H	L	L
60	L	L	L	L	H	H

18.3 Command Mode

This section describes the control method when Mode on the SYS menu is set to Command.

- Pinout

Table 18-5 Pinout

Pin No.	Name	I/O (*1)	Description
1	OPEN	-	Open (*2)
2	/F1	I	Function 1
3	/F2	I	Function 2
4	/F3	I	Function 3
5	/F4	I	Function 4
6	/F5	I	Function 5
7	/F6	I	Function 6
8	/F7	I	Function 7
9	/F8	I	Function 8
10	CMD1	I	Command 1
11	CMD2	I	Command 2
12	CMD3	I	Command 3
13	/STR	I	Strobe
14	ALARM	O	Alarm output
15	GND	-	Ground

*1 Is (inputs) are all pulled up to +3.3 V but can also receive +5 V.

*2 Do not connect anything.

The functions that can be assigned to pins 2 to 9 of the remote connector vary depending on the setting specified by pins 10 to 12 as follows.

Table 18-6 Command mode functions

Pin No.	Name	Function			
		Preset recall (Bit)	Preset recall (Binary)	Switch the display channel	Tally display (SER27)
10	CMD1	H	L	L	H
11	CMD2	H	H	L	H
12	CMD3	H	H	H	L
2	/F1	Recall 1	Recall 1 (LSB)	Selects channel A	Channel A tally 1 display
3	/F2	Recall 2	Recall 2	Selects channel B	Channel A tally 2 display
4	/F3	Recall 3	Recall 3	Selects channel C	Channel B tally 1 display
5	/F4	Recall 4	Recall 4	Selects channel D	Channel B tally 2 display
6	/F5	Recall 5	Recall 5	-	Channel C tally 1 display
7	/F6	Recall 6	Recall 6 (MSB)	-	Channel C tally 2 display
8	/F7	Recall 7	-	-	Channel D tally 1 display
9	/F8	Recall 8	-	-	Channel D tally 2 display

18. REMOTE CONTROL

- Control

Strobe signals are used for Command mode control. Data is retrieved when the strobe signal is at low level. Strobe signals should maintain a stable low level state for at least 350 ms. Before the next command, the strobe signal should maintain a stable high level state for at least 650ms and then set it to a low level.

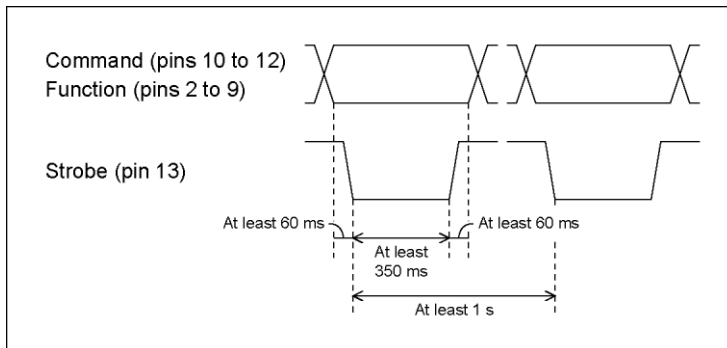

Figure 18-5 Control timing

- Loading presets (Bit)
- Switching Display Channels
- Alarm output

These are the same as Bit mode. See section 18.1, "Bit Mode."

- Loading presets (Binary)

This is the same as Binary mode. See section 18.2, "Binary Mode."

- Tally display (SER27)

You can use pins 2 to 9 of the remote connector to display tallies.

Tallies that you set to low will be turned on, and those that you set to high will be turned off.

To display tallies, you must place TALLY items in the layout or turn Tally Frame on.



Figure 18-6 Tally display

18.4 Tally Mode (SER27)

This section describes the control method when Mode on the SYS menu is set to Tally.

- Pinout

Table 18-7 Pinout

Pin No.	Name	I/O (*1)	Description
1	OPEN	-	Open (*2)
2	/AT1	I	Channel A tally 1 display
3	/AT2	I	Channel A tally 2 display
4	/ATE	I	Channel A tally EX display
5	/BT1	I	Channel B tally 1 display
6	/BT2	I	Channel B tally 2 display
7	/BTE	I	Channel B tally EX display
8	/CT1	I	Channel C tally 1 display
9	/CT2	I	Channel C tally 2 display
10	/CTE	I	Channel C tally EX display
11	/DT1	I	Channel D tally 1 display
12	/DT2	I	Channel D tally 2 display
13	/DTE	I	Channel D tally EX display
14	ALARM	O	Alarm output
15	GND	-	Ground

*1 Is (inputs) are all pulled up to +3.3 V but can also receive +5 V.

*2 Do not connect anything.

18. REMOTE CONTROL

- Control

The input connectors respond to active-low signals. Tallies light at low level and turns off at high level.

Set the low level period to at least 32 ms.

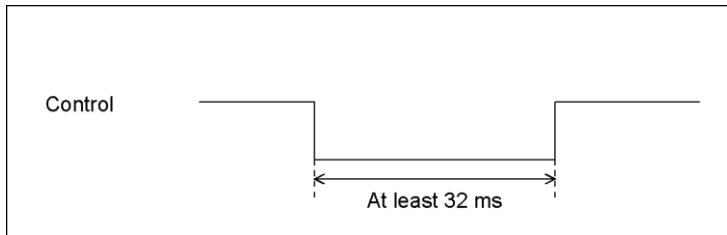

Figure 18-7 Control timing

- Alarm output

These are the same as Bit mode. See section 18.1, "Bit Mode."

- Tally Display

You can use pins 2 to 13 of the remote connector to display tallies.

Tallies that you set to low will be turned on, and those that you set to high will be turned off.

To display tallies, you must place TALLY items in the layout or turn Tally Frame on.

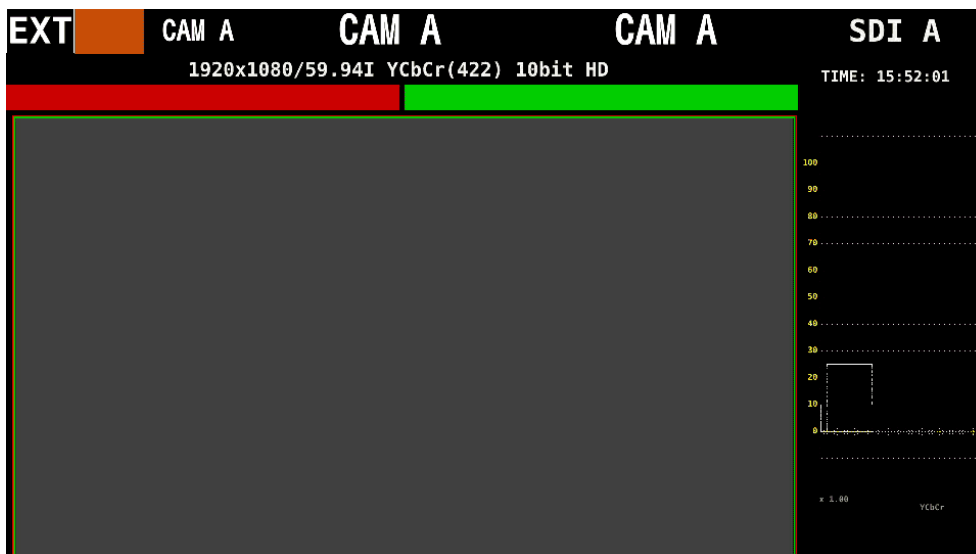

Figure 18-8 Tally display

19. RS-422/485 (SER27)

The instrument can be controlled through its RS-422/485 port on the rear panel.

The Leader's standard protocol is an original control protocol used in previous Leader products. It can be used to recall presets, switch the displayed channels, show the tally display, and show the camera ID display.

The TSL protocol uses the TSL UMD Protocol to control the displaying of tallies (TALLY-1, TALLY-2), and camera ID (LABEL-1).

- RS-422/485 Connector

The RS-422/485 connector as viewed from the rear panel is shown below.

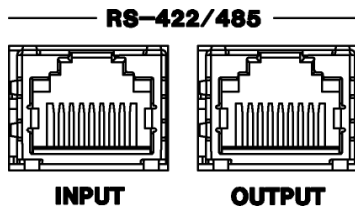

Figure 19-1 RS-422/485 connector

- Interface System

Table 19-1 Interface system

Synchronization mode	Asynchronous start-stop
Data transfer time	9600 to 115200 bps
Data length	8 bit
Parity	None
Stop bits	1 bit
Transmission order	LSB First
Error Detection	Detection through checksum only
Output method	RS485 4-wire
Output connector	RJ-45

- Pinout

Table 19-2 Pinout

Pin No.	Name	Pin No.	Name
1	TX+	5	OPEN
2	TX-	6	RX-
3	RX+	7	GND
4	OPEN	8	GND

19. RS-422/485 (SER27)

- Configuring the instrument

To configure the RS-422/485, use the RS485 tab of the SYS menu.

[See also] 7.2.12, "Configuring the RS-422/485 Settings (SER27)"

To set the camera ID through the RS-422/485 connector, ID Control Select must be set to RS485 on the CAMERA ID tab of the SYS menu.

[See also] 7.2.13, "Setting the Camera ID (SER27)"

To display the tally through the RS-422/485 connector, Tally Control Select must be set to RS485 on the REMOTE tab of the SYS menu.

[See also] 7.2.8, "Configuring the Remote Control Settings"

19.1 Leader's Standard Protocol

19.1.1 Connection Example

An example is shown below of a connection for controlling two instruments from a PC.

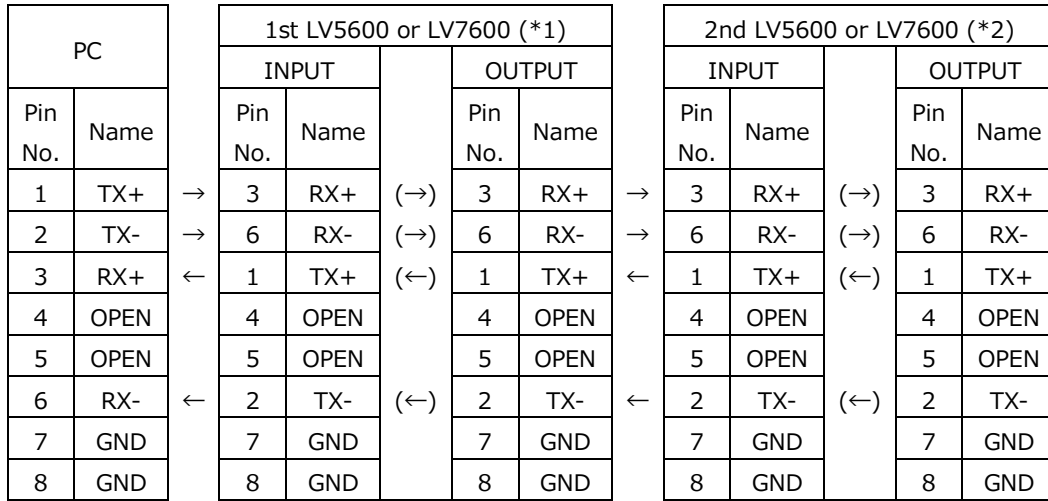

*1 Set Termination Setting on the SYS menu to off.

*2 Set Termination Setting on the SYS menu to on.

19.1.2 Transmission Commands

The transmission command format is shown below.

Table 19-3 Transmission commands

byte	LV5600 Transmission Commands	LV7600 Transmission Commands	Description	Reference
0	02h	02h	STX	-
1	35h	37h	Header 1	-
2	36h	36h	Header 2	-
3	30h	30h	Header 3	-
4	30h	30h	Header 4	-
5	30h to 39h	30h to 39h	Sender IP address 1	"• Setting the Address"
6	30h to 39h	30h to 39h	Sender IP address 2	
7	30h to 39h	30h to 39h	LV5600 or LV7600 address 1	
8	30h to 39h	30h to 39h	LV5600 or LV7600 address 2	
9	30h	30h	RESERVED	-
10	30h	30h	RESERVED	-
11	30h/31h	30h/31h	Keyword 1	"• Setting Keywords and Parameters."
12	30h to 32h	30h to 32h	Keyword 2	
13 and above	-	-	Parameter	
-	30h to 39h/ 41h to 46h	30h to 39h/ 41h to 46h	Checksum 1	"• Setting the Checksum"
-	30h to 39h/ 41h to 46h	30h to 39h/ 41h to 46h	Checksum 2	
-	03h	03h	ETX	-

* If there is a gap of 100 ms or longer in the middle of a command, the command up to that point will be discarded.

* If an incorrect address or format is sent, the command will be ignored.

* After sending a command, verify that it has been acknowledged before sending the next command.

19. RS-422/485 (SER27)

- Setting the Address

Set the address in the range of 00 to 99 using a 4 byte ASCII code.

To set the LV5600 or LV7600 address, use Device Address on the RS485 tab of the SYS menu.

byte	Transmission Commands	Description
5	30h to 39h	Sender IP address 1
6	30h to 39h	Sender IP address 2
7	30h to 39h	LV5600 or LV7600 address 1
8	30h to 39h	LV5600 or LV7600 address 2

Example: To specify "sender address: 28, LV5600 or LV7600 address: 35," set "32h 38h 33h 35h."

- Setting Keywords and Parameters

Keyword and parameter settings vary depending on the function to be controlled.

The command for each function is described below.

- Recalling a Preset

Set the preset in the range of 1 to 60 using a 2 byte ASCII code.

byte	Transmission Commands	Description
11	30h	Keyword 1
12	30h	Keyword 2
13	30h to 36h	Preset 1
14	30h to 39h	Preset 2

Example: To recall preset number 28, set "30h 30h 32h 38h."

- Camera ID Display (collectively setting)

Collectively set the camera ID display of channels A to D.

You can omit the command for channels or labels that do not need to be changed.

To display camera IDs, you must place LABEL-1, LABEL-2, and IRIS items in the customized layout or enhanced layout.

byte	Transmission Commands	Description
11	31h	Keyword 1
12	30h	Keyword 2
13	41h	Ach
14	31h	LABEL-1
15	30h	No change
	31h	Left justified
	32h	Center justified
	33h	Right justified
16 to 31	ASCII code: 1 byte (20h to 7Eh) Shift JIS code: 2byte	<ul style="list-style-type: none"> • 16 bytes max. • Two channels not allowed • Default value (CAM A) if not set
32	2Ch	Separator
33	32h	LABEL-2
34	30h to 33h	Placement (see byte 15)
35 to 50	ASCII/Shift JIS	Character string (see bytes 16 to 31)
51	2Ch	Separator
52	33h	IRIS
53	30h to 33h	Placement (see byte 15)
54 to 69	ASCII/Shift JIS	Character string (see bytes 16 to 31)
70	2Ch	Separator
71	2Ch	Separator
72	42h	Bch
73 to 130	-	Channel B data (see bytes 14 to 71)
131	43h	Cch
132 to 189	-	Channel C data (see bytes 14 to 71)
190	44h	Dch
191 to 248	-	Channel D data (see bytes 14 to 71)

Example: To specify "Ach: LABEL-1=Tokyo1, LABEL-2=Tokyo2, IRIS=(delete), all left justified

Bch: LABEL-1=Osaka1, LABEL-2=Osaka2, IRIS=(no change), all center justified

Cch: all no change

Dch: all delete, set

"31h 30h

41h 31h 31h 93h 8Ch 8Bh 9Eh 31h 2Ch 32h 31h 93h 8Ch 8Bh 9Eh 32h 2Ch 33h 2Ch 2Ch

Ach LABEL-1 LABEL-2 IRIS

42h 31h 32h 91h E5h 8Dh E3h 31h 2Ch 32h 32h 91h E5h 8Dh E3h 32h 2Ch 2Ch

Bch LABEL-1 LABEL-2

44h 31h 2Ch 32h 2Ch 33h 2Ch 2Ch."

Dch LABEL-1 LABEL-2 IRIS

19. RS-422/485 (SER27)

• Camera ID Display (partial setting)

Set the camera ID display for each item.

To display camera IDs, you must place LABEL-1, LABEL-2, and IRIS items in the customized layout or enhanced layout.

byte	Transmission Commands	Description
11	31h	Keyword 1
12	32h	Keyword 2
13	41h	Ach
	42h	Bch
	43h	Cch
	44h	Dch
14	31h	LABEL-1
	32h	LABEL-2
	33h	IRIS
15	30h	No change
	31h	Left justified
	32h	Center justified
	33h	Right justified
16 to 31	ASCII code: 1 byte (20h to 7Eh) Shift JIS code: 2 bytes	<ul style="list-style-type: none"> • 16 bytes max. • Two channels not allowed • Default value (CAM A/B/C/D) if not set
32	2Ch	Separator

Example: To specify "Dch: LABEL-2=Tokyo1, left justified,"
set "31h 32h 44h 32h 31h 93h 8Ch 8Bh 9Eh 31h 2Ch."

- Setting the Checksum

Add the data from the header to the parameters, and set the lower two digits using a 2 byte ASCII code.

As an example, the checksum for the following command will be calculated on the LV5600.

Sender IP address: 01
 LV5600: 00
 Function: Recall preset number 1

When we add the data from the header to the parameters, we obtain

$$35h + 36h + 30h + 30h + 30h + 31h + 30h + 30h + 30h + 30h + 30h + 30h + 30h + 31h = 2ADh$$

Therefore, we set A→41h for checksum1 and D→44h for checksum2.

byte	Transmission Commands	Description
0	02h	STX
1	35h	Header 1
2	36h	Header 2
3	30h	Header 3
4	30h	Header 4
5	30h	Sender IP address 1
6	31h	Sender IP address 2
7	30h	LV5600 address 1
8	30h	LV5600 address 2
9	30h	RESERVED
10	30h	RESERVED
11	30h	Keyword 1
12	30h	Keyword 2
13	30h	Parameter 1
14	31h	Parameter 2
15	(41h)	Checksum 1
16	(44h)	Checksum 2
17	03h	ETX

Checksum calculation range

19.1.3 Response Messages

The following three response messages are available. The format of each is shown below.

Table 19-4 Response messages

byte	LV5600 Response Command			LV7600 Response Command			Description
	Normal	Format error	Checksum error	Normal	Format error	Checksum error	
0	02h	02h	02h	02h	02h	02h	STX
1	35h	35h	35h	37h	37h	37h	Header 1
2	36h	36h	36h	36h	36h	36h	Header 2
3	30h	30h	30h	30h	30h	30h	Header 3
4	30h	30h	30h	30h	30h	30h	Header 4
5	30h to 39h	30h to 39h	30h to 39h	30h to 39h	30h to 39h	30h to 39h	Sender IP address 1
6	30h to 39h	30h to 39h	30h to 39h	30h to 39h	30h to 39h	30h to 39h	Sender IP address 2
7	30h to 39h	30h to 39h	30h to 39h	30h to 39h	30h to 39h	30h to 39h	LV5600 or LV7600 address 1
8	30h to 39h	30h to 39h	30h to 39h	30h to 39h	30h to 39h	30h to 39h	LV5600 or LV7600 address 2
9	30h	30h	30h	30h	30h	30h	RESERVED
10	30h	30h	30h	30h	30h	30h	RESERVED
11	38h	38h	38h	38h	38h	38h	Keyword 1
12	30h	31h	31h	30h	31h	31h	Keyword 2
13	30h	30h	31h	30h	30h	31h	Parameter 1
14	30h	31h	30h	30h	31h	30h	Parameter 2
15	03h	03h	03h	03h	03h	03h	ETX

* Response messages are returned for recalling presets, switching display channels, and displaying tallies when the LV5600 or LV7600 completes the configuration and for displaying camera IDs when the LV5600 or LV7600 receives the command.

* The BUS is set to drive only when a response is returned for a setting command.

19.2 TSL Protocol

19.2.1 Connection Example

An example is shown below of a connection for controlling two instruments from a TSL control device.

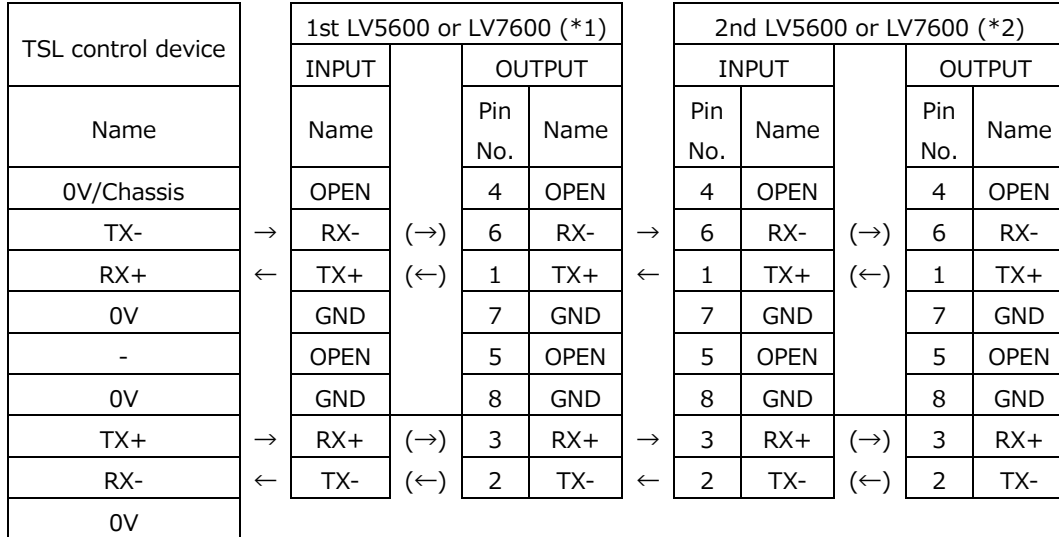

- * Construct an adapter in accordance with the pin arrangement of the TSL control device.
- * Connect only the TX+/- outputs of the TSL control device to this instrument.
- * If there is a voltage supply connector on the TSL control device, do not connect it to this instrument.
- *1 Set Termination Setting on the SYS menu to off.
- *2 Set Termination Setting on the SYS menu to on.

19.2.2 UMD V3.1 Packet Format

| HEADER | CONTROL BYTE | DISPLAY DATA |

- **HEADER** 1 byte
Display Address (0 to 126) + 0x80
- **CONTROL BYTE** 1 byte
 - bit 0 = Turns TALLY-1 on and off (1= On, 0= Off)
 - bit 1 = Turns TALLY-2 on and off (1= On, 0= Off)
 - bit 2-3 = Fixed to zero
 - bit 4-5 = brightness data (not supported)
 - bit 6-7 = Fixed to zero
- **DISPLAY DATA** 16 byte
Display data of the LABEL-1 item (16 ASCII characters)

* Be sure to send 16 characters.

19.2.3 UMD V4.0 Packet Format

| HEADER | CONTROL BYTE | DISPLAY DATA | CHKSUM | VBC | XDATA |

- HEADER 1 byte
Display Address (0 to 126) + 0x80
- CONTROL BYTE 1 byte
 - bit 0 = Turns TALLY-1 on and off (1= On, 0= Off)
 - bit 1 = Turns TALLY-2 on and off (1= On, 0= Off)
 - bit 2-3 = Fixed to zero
 - bit 4-5 = brightness data (not supported)
 - bit 6 = Fixed to 0 (1: Command Data)
 - bit 7 = Fixed to zero
- DISPLAY DATA 16 byte
Display data of the LABEL-1 item (16 ASCII characters)
 - * Be sure to send 16 characters.
- CHKSUM 1 byte
Take the 2's complement of the sum of all packets of the UMD V3.1 header (HEADER, CONTROL BYTE, DISPLAY DATA), divide by 0x80 (128), and make the remainder the checksum.
- VBC 1 byte
 - bit 3-0 = N (bite count of XDATA)
 - bit 6-4 = 000 (minor version V4.0)
 - bit 7 = fixed to 0
- XDATA N byte
This instrument uses only the data of the first byte. Subsequent bytes are not used.
 - bit 0-1 = TALLY-2 item display color and on/off (00= off, 01=RED, 10=GREEN, 11=AMBER) (*1)
 - bit 2-3 = LABEL-1 item display color and on/off (00= off, 01=RED, 10=GREEN, 11=AMBER)
 - bit 4-5 = TALLY-1 item display color and on/off (00= off, 01=RED, 10=GREEN, 11=AMBER) (*2)
 - bit 6 = Fixed the zero (reserved)
 - bit 7 = Fixed to zero
 - *1 The CONTROL BYTE bit 1 setting is prioritized.
 - *2 The CONTROL BYTE bit 0 setting is prioritized.

20. NETWORK CONTROL

The instrument can be remotely controlled through its Ethernet port on the rear panel. Controlling the instrument remotely through its Ethernet interface has only been confirmed to work in a local network environment. LEADER does not guarantee that this feature will work in any network environment.

20.1 SNTP Client Function

The instrument can display time that is synchronized to an NTP server on the network.

20.1.1 How to Use

1. Configure the Ethernet settings on the NETWORK tab of the SYS menu.

Set SNTP Client Select to On, and set the IP address, server IP address, and time zone adjustment. For details on time zone adjustment, see the next section.

[See also] 7.2.6, "Setting the Network IP"

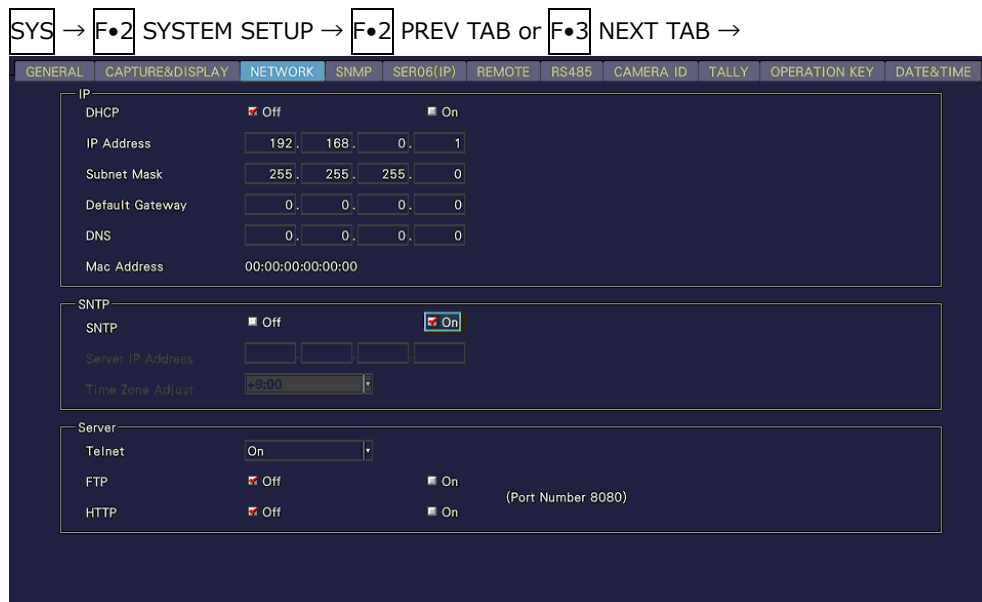

Figure 20-1 NETWORK tab

2. Press F•1 COMPLETE.
3. Connect the instrument's Ethernet port to the external network device.

The instrument connects to the NTP server at the following times.

- When you press F•1 COMPLETE in SYSTEM SETUP
- Once every approximately 10 minutes

When the instrument connects normally to an NTP server, the time is displayed at the upper right of the screen.

If a connection cannot be established, "NTP ERROR" is displayed in red in the TIME box.

20. NETWORK CONTROL

20.1.2 Time Adjustment Value

The date and time exchanged with an NTP (SNTP) are basically Coordinated Universal Time (UTC). Therefore, the time must be adjusted in accordance with the country or region where the device is used in. On the NETWORK tab, set Time Zone Adjust to one of the following values.

Table 20-1 Time adjustment values

Country or region	Time Zone Adjust
Eniwetok, Kwajalein	-12:00
Midway Island, Samoa	-11:00
Hawaii	-10:00
Alaska	-9:00
Pacific Time (US & Canada), Tijuana	-8:00
Mountain Time (US & Canada), Arizona	-7:00
Central Time (US & Canada), Central America, Saskatchewan, Mexico City	-6:00
Eastern Time (US & Canada), Indiana (East), Bogota, Lima, Quito	-5:00
Atlantic Time (Canada), La Paz, Santiago	-4:00
Greenland, Buenos Aires, Georgetown, Brasilia	-3:00
Mid-Atlantic	-2:00
Azores, Cape Verde Is.	-1:00
Greenwich Mean Time (Dublin, Edinburgh, Lisbon, London), Casablanca, Monrovia	0:00
Amsterdam, Berlin, Bern, Rome, Stockholm, Sarajevo, Skopje, Sofija, Vilnius, Warsaw, Zagreb, Brussels, Madrid, Copenhagen, Paris, Belgrade, Bratislava, Budapest, Ljubljana, Prague, West Central Africa	+1:00
Athens, Istanbul, Minsk, Jerusalem, Cairo, Harare, Pretoria, Bucharest, Isinki, Riga, Tallinn	+2:00
Kuwait, Riyadh, Nairobi, Baghdad, Moscow, Volgograd, St. Petersburg	+3:00
Abu Dhabi, Muscat, Baku, Tbilisi, Yerevan	+4:00
Islamabad, Karachi, Tashkent, Ekaterinburg	+5:00
Astana, Dhaka, Almaty, Novosibirsk	+6:00
Krasnoyarsk, Bangkok, Hanoi, Jakarta	+7:00
Irkutsk, Ulaan Bataar, Kuala Lumpur, Singapore, Perth, Taipei, Beijing, Chongqing, Hong Kong SAR, Urumqi	+8:00
Seoul, Yakutsk, Osaka, Sapporo, Tokyo	+9:00
Vladivostok, Canberra, Melbourne, Sydney, Guam, Port Moresby, Brisbane, Hobart	+10:00
Magadan, Solomon Is., New Caledonia	+11:00
Auckland, Wellington, Fiji Islands, Kamchatka, Marshall Is.	+12:00
French Polynesia	-9:30
Newfoundland Standard Time	-3:30
Iran	+3:30
Afghanistan	+4:30
Indian Standard Time, Sri Lanka	+5:30
Nepal	+5:45
Cocos Islands, Myanmar	+6:30

20. NETWORK CONTROL

Country or region	Time Zone Adjust
Western Australia	+8:45
Australian Central Standard Time	+9:30
New South Wales (Lord Howe Island)	+10:30
Phoenix Islands, Tonga, Tokelau	+13:00
Line Islands	+14:00

20.2 TELNET

From a PC connected to the same network as the instrument, you can remotely control most of the operations that can be controlled from the panel.

If you are using the LV7600, read LV5600 and lv5600 as LV7600 and lv7600.

20.2.1 How to Use

1. Configure the Ethernet settings on the NETWORK tab of the SYS menu.

Set the IP address, and set Telnet to On.

You cannot use the LV7290 REMOTE CONTROLLER while using TELNET. Conversely, if you set LV7290 to On, you cannot use TELNET.

[See also] 7.2.8, "Configuring the Server"

SYS → F•2 SYSTEM SETUP → F•2 PREV TAB or F•3 NEXT TAB →

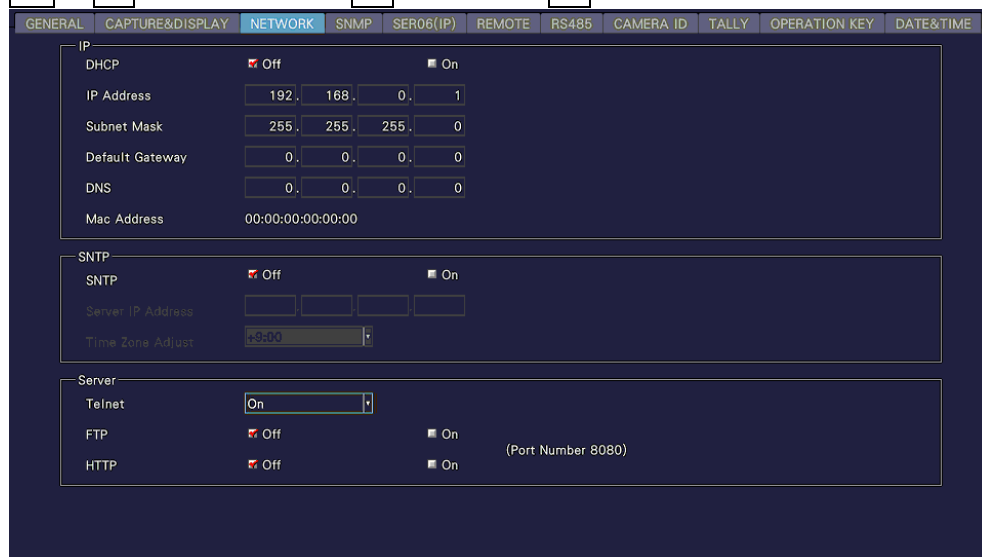

Figure 20-2 NETWORK tab

2. Press F•1 COMPLETE.
3. Connect the instrument's Ethernet port to the external network device.
4. On the PC, start a TELNET client.

On Windows 7, on the taskbar, click Start, and then click Run. Type "TELNET" and the IP address that you set in step 1. Then, click OK.

(To use TELNET, open Control Panel, click Turn Windows features on or off under Program and Features, and select the Telnet Client check box.)

20. NETWORK CONTROL

5. Type the login name and password.

The login name and password are "LV5600". Use uppercase for all characters. When the login name and password are entered correctly, "LV5600@LV5600:~\$" appears.

```
LV5600 login: LV5600
Password: *****
LV5600@LV5600:~$
```

6. Enter TELNET commands.

Enter commands by referring to sections 20.2.2, "How to Enter Commands," and 20.2.3, "TELNET Commands."

To end a TELNET session, type "exit" in lowercase letters.

```
LV5600@LV5600:~$ exit
```

20.2.2 How to Enter Commands

The command syntax is explained below. (Some commands do not have parameters.) To query a current setting, use a question mark as the parameter.

```
LV5600@LV5600:~$ [Command] + [Space] + [Parameter]
```

Examples of how to enter commands are shown below.

- Showing the Status Display

```
LV5600@LV5600:~$ STATUS
```

- Displaying the Center Marker in the Picture Display

```
LV5600@LV5600:~$ PIC:MARKER:CENTER ON
```

- Querying the Vector Intensity

```
LV5600@LV5600:~$ VECTOR:INTEN ?
```

- * You can enter commands using uppercase or lowercase letters.
- * Because the display channel selection command is different depending on the display mode (single or simul) and SDI signal input settings, check the INPUT KEY command.
- * To query the measured value or detected value, you must use the INPUT KEY command to show the measurement screen of the appropriate channel.
Further, for 4K 3G Quad Link, 4K 3G Dual Link, 4K HD Quad Link, 3G Dual Link, and HD Dual Link settings, you must also select the link according to the link selection command of each measurement item.

20. NETWORK CONTROL

20.2.3 TELNET Commands

TELNET commands follow the instrument or the option menu structure. Some of the descriptions do not apply depending on the installed options or the current settings.

• INPUT KEY

r/w Limitation	Command	Parameter	
-	INPUT	SINGLE / SIMUL / ?	
-	INPUT:SINGLE_A	ON / ? (Return value:ON (Channel A selected) / OFF (not selected))	SD/HD/3G-A/3G-B-DL, 3G-B DS setting, Select the display channel in single input mode.
-	INPUT:SINGLE_B	ON / ? (Return value:ON (Channel B selected) / OFF (not selected))	
-	INPUT:SINGLE_C	ON / ? (Return value:ON (Channel C selected) / OFF (not selected))	
-	INPUT:SINGLE_D	ON / ? (Return value:ON (Channel D selected) / OFF (not selected))	
-	INPUT:SIMUL_A	OFF / ON / ? (Return value:Channel A display on/off)	SD/HD/3G-A/3G-B-DL, 3G-B DS setting, Select the display channel in simul mode.
-	INPUT:SIMUL_B	OFF / ON / ? (Return value:Channel B display on/off)	
-	INPUT:SIMUL_C	OFF / ON / ? (Return value:Channel C display on/off)	
-	INPUT:SIMUL_D	OFF / ON / ? (Return value:Channel D display on/off)	
-	INPUT:12G_A	ON / ? (Return value:ON (Channel A selected) / OFF (not selected))	4K 12G setting, Select the display channel.
-	INPUT:12G_B	ON / ? (Return value:ON (Channel B selected) / OFF (not selected))	
-	INPUT:12G_C	ON / ? (Return value:ON (Channel C selected) / OFF (not selected))	
-	INPUT:12G_D	ON / ? (Return value:ON (Channel D selected) / OFF (not selected))	
-	INPUT:SINGLE_DUAL_AB	ON / ? (Return value: Channel A-B pair display on/off(not selected))	4K 3G Dual Link, HD Dual Link, 3G Dual Link setting, Select the display channel in single input mode.
-	INPUT:SINGLE_DUAL_CD	ON / ? (Return value: Channel C-D pair display on/off(not selected))	
-	INPUT:SIMUL_DUAL_AB	OFF / ON / ? (Return value: Channel A-B pair display on/off)	HD Dual Link, 3G Dual Link setting, Select the display channel in simul mode.
-	INPUT:SIMUL_DUAL_CD	OFF / ON / ? (Return value:Channel C-D pair display on/off)	
-	INPUT:OPERATE	COM / INDIVIDUAL / ?	
-	INPUT:6G_A	ON / ? (Return value:ON (Channel A selected) / OFF (not selected))	4K 6G setting, Select the display channel.
-	INPUT:6G_B	ON / ? (Return value:ON (Channel B selected) / OFF (not selected))	
-	INPUT:6G_C	ON / ? (Return value:ON (Channel C selected) / OFF (not selected))	
-	INPUT:6G_D	ON / ? (Return value:ON (Channel D selected) / OFF (not selected))	

20. NETWORK CONTROL

r/w Limitation	Command	Parameter	
-	INPUT_CHANGE	1 / 2 / 3 / 4 / ?	<p>Input switching is possible on all SDI systems. (Equivalent to input switching by SNMP)</p> <p>* Switch between 1:A-Bch and 3:C-Dch when the 4K 3G Dual Link, 2K HD Dual Link, 2K 3G Dual Link, or 4K 2 screen is displayed.</p>

• EXT KEY

r/w Limitation	Command	Parameter
-	EXT	INT / EXT / ?

• CAP KEY

r/w Limitation	Command	Parameter
-	CAP:TRIGGER	MANUAL / ERROR / ?
WO	CAP:REFRESH	None
-	CAP:DISPLAY	REAL / HOLD / BOTH / ?
-	CAP:FILE:BMP	OFF / ON / ?
-	CAP:FILE:BSG	OFF / ON / ?
-	CAP:FILE:DPX	OFF / ON / ?
-	CAP:FILE:TIF	OFF / ON / ?
-	CAP:FILE:FRM	OFF / ON / ?
WO	CAP:STORE	None
WO	MAKE	<p>CAP_BMP / CAP_BSG</p> <p>CAP_DPX_A / CAP_DPX_B / CAP_DPX_C / CAP_DPX_D / CAP_TIF_A / CAP_TIF_B / CAP_TIF_C / CAP_TIF_D / CAP_FRM_A / CAP_FRM_B / CAP_FRM_C / CAP_FRM_D (*1) /</p> <p>LOG / DUMP / LOUDNESS (*2) /</p> <p>SCTE104_TEXT / SCTE104_SPLICE</p> <p>* File make command. Use FTP to retrieve created files.</p> <p>*1 If you want to create a frame capture file (DPX, TIF, FRM), a video signal waveform, vector waveform, or picture must be displayed on the screen.</p> <p>*2 If you want to create an event log, data dump, or loudness file, the corresponding measurement screen must be displayed on the screen.</p>
-	CAP:FRM:CAPNUM	1 / 16 / ?

20. NETWORK CONTROL

• PRESET KEY

r/w Limitation	Command	Parameter
WO	RCLL	1 to 60

• MULTI KEY

r/w Limitation	Command	Parameter
-	MULTI	OFF / ON / ?
WO	USER:LYT	USER1 / USER2 / USER3 / USER4 / USER5 / USER6

• SYS KEY

r/w Limitation	Command	Parameter
-	SYS:LCD:BACKLIGHT	1 to 32 / ?
WO	SYS:LCD:ON	None
WO	SYS:LCD:OFF	None
WO	SYS:INITIALIZE:PARAM	None
WO	SYS:INITIALIZE:LAYOUT	None
WO	SYS:INITIALIZE:OPERATE	None
WO	SYS:INITIALIZE:ALL	None
-	SYS:SDI:SYSTEM	4K_12G / 4K_6G / 4K_3G_QLINK / 4K_3G_DLINK / 4K_HD_QLINK / SINGLE_LINK / HD_DLINK / 3G_DLINK / 3GB_DSTREAM / 4K_IP_SINGLE / 4K_IP_QUAD / ? * Correspondence between parameters and settings 4K_12G : 4K 12G 4K_3G_QLINK : 4K 3G Quad Link 4K_3G_DLINK : 4K 3G Dual Link 4K_HD_QLINK : 4K HD Quad Link SINGLE_LINK : SD/HD/3G-A/3G-B-DL HD_DLINK : HD Dual Link 3G_DLINK : 3G Dual Link 3GB_DSTREAM : 3G-B DS
-	SYS:SDI:COLORIMETRY	PAYLOAD_ID / BT709 / BT2020 / DCI / ?
-	SYS:XYZ_GAMMA	BOTTOM_ZERO / DCI / ?
-	SYS:HDR:MODE_A	OFF / HLG / PQ / SLOG3 / CLOG / LOGC / ?
-	SYS:HDR:MODE_B	OFF / HLG / PQ / SLOG3 / CLOG / LOGC / ?
-	SYS:HDR:MODE_C	OFF / HLG / PQ / SLOG3 / CLOG / LOGC / ?
-	SYS:HDR:MODE_D	OFF / HLG / PQ / SLOG3 / CLOG / LOGC / ?
-	SYS:HDR:GAMMA_A	OFF / ON / ?
-	SYS:HDR:GAMMA_B	OFF / ON / ?
-	SYS:HDR:GAMMA_C	OFF / ON / ?
-	SYS:HDR:GAMMA_D	OFF / ON / ?
-	SYS:HDR:HLG_SCALE_A	1200P / 100P / ?
-	SYS:HDR:HLG_SCALE_B	1200P / 100P / ?
-	SYS:HDR:HLG_SCALE_C	1200P / 100P / ?
-	SYS:HDR:HLG_SCALE_D	1200P / 100P / ?
-	SYS:HDR:RANGE_A	NARROW / FULL / ?
-	SYS:HDR:RANGE_B	NARROW / FULL / ?
-	SYS:HDR:RANGE_C	NARROW / FULL / ?
-	SYS:HDR:RANGE_D	NARROW / FULL / ?
-	SYS:HDR:EI_A	EI200 / EI400 / EI800 / EI1600 / ?
-	SYS:HDR:EI_B	EI200 / EI400 / EI800 / EI1600 / ?
-	SYS:HDR:EI_C	EI200 / EI400 / EI800 / EI1600 / ?

20. NETWORK CONTROL

-	SYS:HDR:EI_D	EI200 / EI400 / EI800 / EI1600 / ?
-	SYS:HDR:DETECT_PAYLOAD_A	OFF / ON / ?
-	SYS:HDR:DETECT_PAYLOAD_B	OFF / ON / ?
-	SYS:HDR:DETECT_PAYLOAD_C	OFF / ON / ?
-	SYS:HDR:DETECT_PAYLOAD_D	OFF / ON / ?
-	SYS:HDR:REF_LV_HLG_A	50P / 75P / ?
-	SYS:HDR:REF_LV_HLG_B	50P / 75P / ?
-	SYS:HDR:REF_LV_HLG_C	50P / 75P / ?
-	SYS:HDR:REF_LV_HLG_D	50P / 75P / ?
-	SYS:HDR:REF_LV_PQ_A	51P / 58P / ?
-	SYS:HDR:REF_LV_PQ_B	51P / 58P / ?
-	SYS:HDR:REF_LV_PQ_C	51P / 58P / ?
-	SYS:HDR:REF_LV_PQ_D	51P / 58P / ?
-	SYS:IP1:VID:SRC:MASK	[port] [stream] [? / <value>] (*1)
-	SYS:IP1:VID:SRC:ADDR	[port] [stream] [? / <value>] (*1)
-	SYS:IP1:VID:DST:MASK	[port] [stream] [? / <value>] (*1)
-	SYS:IP1:VID:DST:ADDR	[port] [stream] [? / <value>] (*1)
-	SYS:IP1:VID:DST:PORT	[port] [stream] [? / <value>] (*1)
-	SYS:IP1:AUD:SRC:MASK	[port] [stream] [? / <value>] (*1)
-	SYS:IP1:AUD:SRC:ADDR	[port] [stream] [? / <value>] (*1)
-	SYS:IP1:AUD:DST:MASK	[port] [stream] [? / <value>] (*1)
-	SYS:IP1:AUD:DST:ADDR	[port] [stream] [? / <value>] (*1)
-	SYS:IP1:AUD:DST:PORT	[port] [stream] [? / <value>] (*1)
-	SYS:IP1:ANC:SRC:MASK	[port] [stream] [? / <value>] (*1)
-	SYS:IP1:ANC:SRC:ADDR	[port] [stream] [? / <value>] (*1)
-	SYS:IP1:ANC:DST:MASK	[port] [stream] [? / <value>] (*1)
-	SYS:IP1:ANC:DST:ADDR	[port] [stream] [? / <value>] (*1)
-	SYS:IP1:ANC:DST:PORT	[port] [stream] [? / <value>] (*1)
-	SYS:IP1:STREAM1:AUD:CH_MAP	OFF / ON / ?
-	SYS:IP1:STREAM2:AUD:CH_MAP	OFF / ON / ?
-	SYS:IP1:STREAM3:AUD:CH_MAP	OFF / ON / ?
-	SYS:IP1:STREAM4:AUD:CH_MAP	OFF / ON / ?
-	SYS:IP1:STREAM1:AUD:CH_NUM:G1	0 - 16 / ?
-	SYS:IP1:STREAM1:AUD:CH_NUM:G2	0 - 16 / ?
-	SYS:IP1:STREAM1:AUD:CH_NUM:G3	0 - 16 / ?
-	SYS:IP1:STREAM1:AUD:CH_NUM:G4	0 - 16 / ?
-	SYS:IP1:STREAM2:AUD:CH_NUM:G1	0 - 16 / ?
-	SYS:IP1:STREAM2:AUD:CH_NUM:G2	0 - 16 / ?
-	SYS:IP1:STREAM2:AUD:CH_NUM:G3	0 - 16 / ?
-	SYS:IP1:STREAM2:AUD:CH_NUM:G4	0 - 16 / ?
-	SYS:IP1:STREAM3:AUD:CH_NUM:G1	0 - 16 / ?
-	SYS:IP1:STREAM3:AUD:CH_NUM:G2	0 - 16 / ?
-	SYS:IP1:STREAM3:AUD:CH_NUM:G3	0 - 16 / ?
-	SYS:IP1:STREAM3:AUD:CH_NUM:G4	0 - 16 / ?
-	SYS:IP1:STREAM4:AUD:CH_NUM:G1	0 - 16 / ?
-	SYS:IP1:STREAM4:AUD:CH_NUM:G2	0 - 16 / ?
-	SYS:IP1:STREAM4:AUD:CH_NUM:G3	0 - 16 / ?
-	SYS:IP1:STREAM4:AUD:CH_NUM:G4	0 - 16 / ?

*1 Specify three parameters. For the first parameter, specify the port number (1 or 2). For the second parameter, specify the stream number (1 to 4). If the third parameter option is set to "?", the current value will be returned.

If the port number or stream number range is exceeded, the command will operate as if 1 is specified.

Example: Change the Video Destination Address of Port1 Stream3 to 192.168.0.8.

SYS:IP1:VID:DST:ADDR 1 3 192.168.0.8

20. NETWORK CONTROL

- WFM KEY

r/w Limitation	Command	Parameter
WO	WFM	None
-	WFM:MODE	OVERLAY / PARADE / ?
-	WFM:MODE:YCBCR:Y	ON / OFF / ?
-	WFM:MODE:YCBCR:CB	ON / OFF / ?
-	WFM:MODE:YCBCR:CR	ON / OFF / ?
-	WFM:MODE:GBR:G	ON / OFF / ?
-	WFM:MODE:GBR:B	ON / OFF / ?
-	WFM:MODE:GBR:R	ON / OFF / ?
-	WFM:MODE:RGB:R	ON / OFF / ?
-	WFM:MODE:RGB:G	ON / OFF / ?
-	WFM:MODE:RGB:B	ON / OFF / ?
-	WFM:MODE:XYZ:X	ON / OFF / ?
-	WFM:MODE:XYZ:Y	ON / OFF / ?
-	WFM:MODE:XYZ:Z	ON / OFF / ?
-	WFM:MODE:4Y_PARADE	ON / OFF / ?
-	WFM:MODE:3G-B-DS	STREAM1 / STREAM2 / MIX / ALIGN / ?
-	WFM:EXT_SYNC	ON / OFF / ?
-	WFM:EXT_SYNC:INTEN	-128 to 127 / ?
-	WFM:EXT_SYNC:COLOR	WHITE / YELLOW / CYAN / GREEN / MAGENTA / RED / BLUE / ?
-	WFM:INTEN	-128 to 127 / ?
-	WFM:COLOR	WHITE / YELLOW / CYAN / GREEN / MAGENTA / RED / BLUE / MULTI / ?
-	WFM:COLOR:S1	WHITE / YELLOW / CYAN / GREEN / MAGENTA / RED / BLUE / MULTI / ?
-	WFM:COLOR:S2	WHITE / YELLOW / CYAN / GREEN / MAGENTA / RED / BLUE / MULTI / ?
-	WFM:SCALE:INTEN	-8 to 7 / ?
-	WFM:SCALE:COLOR	WHITE / YELLOW / CYAN / GREEN / MAGENTA / RED / BLUE / ?
-	WFM:SCALE:UNIT	HDV_SDP / HDV_SDV / HDP_SDP / CV_DEC / CV_HEX / ?
-	WFM:SCALE:UNIT:NTSC	P / ?
-	WFM:SCALE:UNIT:PAL	V / ?
-	WFM:SCALE:UNIT:FULL	HDP_SDP / CV_DEC / CV_HEX / ?
-	WFM:SCALE:75_COLOR	ON / OFF / ?
-	WFM:SCALE:DISPLAY	ON / OFF / BOTH / MAIN / HDR / ?
-	WFM:GAIN:VARIABLE	CAL / VAR / ?
-	WFM:GAIN:MAG	X1 / X5 / X10 / ?
-	WFM:GAIN:VALUE	20 to 200 / ? * MAG value × 0.200 (20) - 2.000 (200)
-	WFM:GAIN:SCALE_JUMP	0P / 10P / 20P / 30P / 40P / 50P / 60P / 70P / 80P / 90P / 100P / CURSOR / ?
-	WFM:FILTER:NORMAL	FLAT / LOWPASS / ?
-	WFM:FILTER:COMPOSITE	FLAT / LUM / FLAT_LUM / LUM_CRMA / ?
-	WFM:SWEEP	H / V / ?
-	WFM:SWEEP:H_SWEEP	1H / 2H / ?
-	WFM:SWEEP:V_SWEEP	1V / 2V / ?
-	WFM:SWEEP:H_MAG	X1 / X10 / X20 / ACTIVE / BLANK / ?
-	WFM:SWEEP:V_MAG	X1 / X20 / X40 / ?
-	WFM:SWEEP:FIELD	FIELD1 / FIELD2 / ?
-	WFM:BLANKING:NORMAL	REMOVE / H_VIEW / V_VIEW / ALL_VIEW / ?
-	WFM:BLANKING:COMPOSITE	REMOVE / V_VIEW / ?

20. NETWORK CONTROL

-	WFM:CURSOR	SINGLE / BOTH / OFF / ?
-	WFM:CURSOR:SELECT	X / Y / ?
-	WFM:CURSOR:UNIT:X	SEC / HZ / ?
-	WFM:CURSOR:UNIT:Y	MV / P / RP / DEC / HEX / HDR / ?
-	WFM:CURSOR:UNIT:Y:COMPOSITE	MV / P / RP / ?
-	WFM:CURSOR:FD	REF / DELTA / TRACK / ?
-	WFM:CURSOR:REF	0 to 927 (when X is selected) -5000 to 15000 (when Y is selected)
-	WFM:CURSOR:DELTA	0 to 927 (when X is selected) -5000 to 15000 (when Y is selected)
-	WFM:CURSOR:TRACK	0 to 927 (when X is selected) -15000 to 15000 (when Y is selected)
WO	WFM:CURSOR:REFSET	None
-	WFM:CURSOR:VAL	ON / OFF / ?
-	WFM:LINE_SELECT	ON / OFF / CINELITE / ?
-	WFM:LINE_NUMBER	0 to 32767 / ?
-	WFM:LINE_FIELD	FIELD1 / FIELD2 / FRAME / ?
-	WFM:MATRIX:YCBCR	YCBCR / GBR / RGB / COMPOSITE / ?
-	WFM:MATRIX:RGB	GBR / RGB / COMPOSITE / ?
-	WFM:MATRIX:YGBR	ON / OFF / ?
-	WFM:MATRIX:YRGB	ON / OFF / ?
-	WFM:MATRIX:COMPOSITE:FORMAT	AUTO / NTSC / PAL / ?
-	WFM:MATRIX:COMPOSITE:SETUP	0P / 7.5P / ?
-	WFM:MATRIX:XYZ	XYZ / GBR / RGB / COMPOSITE / ?

- VECTOR KEY

r/w Limitation	Command	Parameter
WO	VECTOR	None
-	VECTOR:LINE_SELECT	ON / OFF / CINELITE / ?
-	VECTOR:LINE_NUMBER	0 to 32767 / ?
-	VECTOR:LINE_FIELD	FIELD1 / FIELD2 / FRAME / ?
-	VECTOR:MATRIX:CB	100P / 75P / ?
-	VECTOR:MATRIX:COLOR_MATRIX	COMPONENT / COMPOSITE / ?
-	VECTOR:MATRIX:COMPOSITE:FORMAT	AUTO / NTSC / PAL / ?
-	VECTOR:MATRIX:COMPOSITE:SETUP	0P / 7_5P / ?
-	VECTOR:VECTOR:MODE	VECTOR / RGBVECTOR / YCBCRVECTOR / ?
-	VECTOR:VECTOR:INTEN	-128 to 127 / ?
-	VECTOR:VECTOR:COLOR	WHITE / YELLOW / CYAN / GREEN / MAGENTA / RED / BLUE / ?
-	VECTOR:VECTOR:COLOR:S1	WHITE / YELLOW / CYAN / GREEN / MAGENTA / RED / BLUE / ?
-	VECTOR:VECTOR:COLOR:S2	WHITE / YELLOW / CYAN / GREEN / MAGENTA / RED / BLUE / ?
-	VECTOR:VECTOR:3G-B-DS	STREAM1 / STREAM2 / MIX / ALIGN / ?
-	VECTOR:VECTOR:SCALE:INTEN	-8 to 7 / ?
-	VECTOR:VECTOR:SCALE:COLOR	WHITE / YELLOW / CYAN / GREEN / MAGENTA / RED / BLUE / ?
-	VECTOR:VECTOR:SCALE:IQ_AXIS	ON / OFF / ?
-	VECTOR:VECTOR:SCALE:VEC_SCALE	AUTO / BT601 / BT709 / BT2020 / DCI / ?
-	VECTOR:VECTOR:SCALE:VAR_SCALE	ON / OFF / ?
-	VECTOR:VECTOR:GAIN:VARIABLE	CAL / VAR / ?
-	VECTOR:VECTOR:GAIN:MAG	X1 / X5 / IQ / ?

20. NETWORK CONTROL

-	VECTOR:VECTOR:GAIN:VALUE	200 to 2000 / ? * X1 1000 to 10000 / ? * X5 580 to 5840 / ? * IQ-MAG or SD, composite display 620 to 6240 / ? * not IQ-MAG or SD, component display 520 to 5260 / ? * IQ-MAG or SD, for pseudo-composite display 570 to 5700 / ? * not IQ-MAG or SD, for pseudo-composite display
-	VECTOR:GAIN:GUIDE_DISP	ON / OFF / ?
-	VECTOR:VECTOR:MARKER	ON / OFF / ?
-	VECTOR:VECTOR:VAR_MKR:MKR_SIZE	5 to 10 / ?
-	VECTOR:RGBVECTOR:SCALE:ADJ_TARGET	GB / GR / ?
-	VECTOR:RGBVECTOR:SCALE:H	-500 to 500 / ?
-	VECTOR:RGBVECTOR:SCALE:V	-500 to 500 / ?
-	VECTOR:RGBVECTOR:GAIN:H	200 to 2000 / ? * 0.200 (200) - 2.000 (2000)
-	VECTOR:RGBVECTOR:GAIN:V	200 to 2000 / ? * 0.200 (200) - 2.000 (2000)
-	VECTOR:YBCRVECTOR:SCALE:TIM_MKR	AUTO / HD / SD / ?
-	VECTOR:YBCRVECTOR:SCALE:VEC_SCALE	AUTO / BT601 / BT709 / BT2020 / DCI / ?
-	VECTOR:YBCRVECTOR:GAIN:VARIABLE	CAL / VAR / ?
-	VECTOR:YBCRVECTOR:GAIN:MAG	X1 / X5 / ?
-	VECTOR:YBCRVECTOR:GAIN:VALUE	200 to 2000 / ? * MAG value × 0.200 (200) - 2.000 (2000)
-	VECTOR:YBCRVECTOR:GAIN:OBS_POINT	BY_WH / BY_YL / BY_CY / BY_G / BY_TM / BY_MG / BY_R / BY_B / BL / RY_B / RY_R / RY_MG / RY_TM / RY_G / RY_CY / RY_YL / RY_WH / ?
RO	VECTOR:5BAR:Y:DATA	?
RO	VECTOR:5BAR:G:DATA	?
RO	VECTOR:5BAR:B:DATA	?
RO	VECTOR:5BAR:R:DATA	?
RO	VECTOR:5BAR:CMP:DATA	?
-	VECTOR:5BAR:SCALE	P / MV / HEX / DEC / ?
-	VECTOR:5BAR:SEQUENCE	GBR / RGB / ?
-	VECTOR:HIST:SCALE	P / HDR / ?
-	VECTOR:HIST:FORM	SINGLE / TILE / ALIGN_H / ALIGN_V / ?
-	VECTOR:HIST:Y	ON / OFF / ?
-	VECTOR:HIST:R	ON / OFF / ?
-	VECTOR:HIST:G	ON / OFF / ?
-	VECTOR:HIST:B	ON / OFF / ?
-	VECTOR:CIE:SCALE:COLOR	BG_COLOR / BG_WHITE / BG_BLACK / ?
-	VECTOR:CIE:SCALE:TRIANGLE1	OFF / BT601_525 / BT601_625 / BT709 / DCI / BT2020 / ?
-	VECTOR:CIE:SCALE:TRIANGLE2	OFF / BT601_525 / BT601_625 / BT709 / DCI / BT2020 / ?
-	VECTOR:CIE:SCALE:USER_TRIANGLE	1 / 2 / OFF / ?
-	VECTOR:CIE:SCALE:USER_TRIANGLE:COLOR	G / B / R / ?
-	VECTOR:CIE:SCALE:USER_TRIANGLE1:X	0 to 1000 / ? * 0(0.000) - 1000(1.000)
-	VECTOR:CIE:SCALE:USER_TRIANGLE1:Y	0 to 1000 / ? * 0(0.000) - 1000(1.000)
-	VECTOR:CIE:SCALE:USER_TRIANGLE2:X	0 to 1000 / ? * 0(0.000) - 1000(1.000)

20. NETWORK CONTROL

-	VECTOR:CIE:SCALE:USER_TRIANGLE2:Y	0 to 1000 / ? * 0(0.000) - 1000(1.000)
-	VECTOR:CIE:SCALE:SUB:TEMP_SCALE	ON / OFF / ?
-	VECTOR:CIE:SCALE:SUB:GRID	ON / OFF / ?
-	VECTOR:CIE:SCALE:SUB:D65	ON / OFF / ?
-	VECTOR:CIE:SCALE:SUB:CAP	ON / OFF / ?
-	VECTOR:CIE:SCALE:SUB:WP_LABEL	ON / OFF / ?
-	VECTOR:CIE:MODE	DIAGRAM / TEMP / ?
-	VECTOR:CIE:STANDARD	CIE1931 / CIE1976 / ?
-	VECTOR:CIE:CLIP	ON / OFF / ?
-	VECTOR:CIE:FILTER	ON / OFF / ?
-	VECTOR:CIE:MANUAL	ON / OFF / ?
-	VECTOR:CIE:MANUAL:COLORIMETRY	BT601_525 / BT610_625 / BT709 / DCI / BT2020 / ?
-	VECTOR:CIE:MANUAL:GAMMA	150 to 300 / ? * 150(1.50) - 300(3.00)
-	VECTOR:CIE:CURSOR	ON / OFF / ?

• PICTURE KEY

r/w Limitation	Command	Parameter
WO	PICTURE	None
-	PIC:MODE	FIT / REAL / X2 / FULL_FRAME / ?
-	PIC:COLOR	MONO / COLOR / ?
-	PIC:CHROMA	UP / NORMAL / ?
-	PIC:BRIGHTNESS	-500 to 500 / ? * -500(-50.0%) - 500(50.0%)
-	PIC:CONTRAST	0 to 2000 / ? * 0(0%) - 2000(200.0%)
-	PIC:GAIN:R	0 to 2000 / ? * 0(0%) - 2000(200.0%)
-	PIC:GAIN:G	0 to 2000 / ? * 0(0%) - 2000(200.0%)
-	PIC:GAIN:B	0 to 2000 / ? * 0(0%) - 2000(200.0%)
-	PIC:GAIN:CHROMA	0 to 2000 / ? * 0(0%) - 2000(200.0%)
-	PIC:BIAS:R	-500 to 500 / ? * -500(-50.0%) - 500(50.0%)
-	PIC:BIAS:G	-500 to 500 / ? * -500(-50.0%) - 500(50.0%)
-	PIC:BIAS:B	-500 to 500 / ? * -500(-50.0%) - 500(50.0%)
-	PIC:DISP:GAMUT	OFF / WHITE / RED / MESH / ?
-	PIC:DISP:STATUS_INFO	ON / OFF / ?
-	PIC:DISP:3G-B-DS	STREAM1 / STREAM2 / ALIGN / ?
-	PIC:MARKER:FRAME	ON / OFF / ?
-	PIC:MARKER:CENTER	ON / OFF / ?
-	PIC:MARKER:ASPECT	OFF / 17_9 / 16_9 / 14_9 / 13_9 / 4_3 / 2.93_1 / AFD / ?
-	PIC:MARKER:ASPECT:SHADOW	0 to 100 / ?
-	PIC:MARKER:SAFE:ACTION	ARIB / SMPTE / USER1 / OFF / ?
-	PIC:MARKER:SAFE:TITLE	ARIB / SMPTE / USER2 / OFF / ?
-	PIC:MARKER:SAFE:USER1:WIDTH	0 to 100 / ?
-	PIC:MARKER:SAFE:USER1:HEIGHT	0 to 100 / ?
-	PIC:MARKER:SAFE:USER2:WIDTH	0 to 100 / ?
-	PIC:MARKER:SAFE:USER2:HEIGHT	0 to 100 / ?

20. NETWORK CONTROL

-	PIC:MARKER:SAFE:USER1_2:ASPECT	ON / OFF / ?
-	PIC:SUPER_IMPOSE	OFF / SMPTE / ARIB / TELETEXT / ?
-	PIC:SUPER_IMPOSE:FORMAT	FMT_608_708 / FMT_608_608 / FMT_VBI / FMT_708 / ? * CC_SMPTE SD / HD / ANALOG / CELLUAR / ? * CC_ARIB
-	PIC:SUPER_IMPOSE:WST_TRANSPORT	VBI / OP47 / ?
-	PIC:SUPER_IMPOSE:LANGUAGE	CC1 / CC2 / CC3 / CC4 / TEXT1 / TEXT2 / TEXT3 / TEXT4 / ? * CC_SMPTE 1 / 2 / ? * CC_ARIB
-	PIC:SUPER_IMPOSE:MAGAZINE	1 to 8 / ?
-	PIC:SUPER_IMPOSE:PAGE	0 to 255 / ?
-	PIC:SUPER_IMPOSE:SERVICE_DATA	1 to 63 / ?
-	PIC:SUPER_IMPOSE:CS_LOG	START / STOP / ?
-	PIC:SUPER_IMPOSE:CS_LOG:LOUDNESS	ON / OFF / ?
WO	PIC:SUPER_IMPOSE:CS_LOG:CLEAR	None
-	PIC:SUPER_IMPOSE:CS_LOG:MODE	OVER_WRITE / STOP / ?
WO	PIC:SUPER_IMPOSE:CLEAR	None
-	PIC:SUPER_IMPOSE:CONTENT	ON / OFF / ?
-	PIC:CINELITE:DISPLAY	OFF / FSTOP / P_DISPLAY / CINEZONE / PER_CINE / ?
-	PIC:CINELITE:ADVANCE	ON / OFF / ?
-	PIC:CINELITE:MEASURE_NUMBERS	P1 / P1+P2 / P1+P2+P3 / ?
-	PIC:CINELITE:MEASURE_POSITION	P1 / P2 / P3 / ?
-	PIC:CINELITE:MEASURE_SIZE	1X1 / 3X3 / 9X9 / ?
RO	PIC:CINELITE:P1_DATA	?
RO	PIC:CINELITE:P2_DATA	?
RO	PIC:CINELITE:P3_DATA	?
-	PIC:CINELITE:MAX_FALL_CLL	ON / OFF / ?
-	PIC:CINELITE:MAX_FALL_CLL:MEASURE	STOP / START / ?
WO	PIC:CINELITE:MAX_FALL_CLL:CLEAR	None
WO	PIC:CINELITE:FSTOP:18P_REF_SET	None
-	PIC:CINELITE:FSTOP:GAMMA_SELECT	0.45 / USER1 / USER2 / USER3 / USER_A / USER_B / USER_C / USER_D / USER_E / ?
WO	PIC:CINELITE:FSTOP:GAMMA:CAL:TABLE_CLEAR	None
WO	PIC:CINELITE:FSTOP:GAMMA:CAL:1_DATA_CLEAR	None
WO	PIC:CINELITE:FSTOP:GAMMA:CAL:SET	None
-	PIC:CINELITE:FSTOP:GAMMA:CAL:F	22.0 / 16.0 / 11.0 / 8.0 / 5.6 / 4.0 / 2.8 / 2.0 / ?
WO	PIC:CINELITE:FSTOP:GAMMA:FILE:TABLE_CLEAR	None
-	PIC:CINELITE:LINE	0 to 32767 / ?
-	PIC:CINELITE:SAMPLE	0 to 32767 / ?
-	PIC:CINELITE:P_DISPLAY:UNIT_SELECT	Y_P / RGB_P / RGB255 / ? * MEASURE SIZE : not 1x1 Y_P / RGB_P / RGB255 / CV_HEX / CV_DEC / ? * MEASURE SIZE : 1x1, input signal: not XYZ Y_P / RGB_P / RGB255 / CV_XYZ_HEX / CV_XYZ_DEC / CV_RGB_HEX / CV_RGB_DEC / ? * MEASURE SIZE : 1x1, input signal : XYZ
-	PIC:CINELITE:CINEZONE:FORM	GRADATE / STEP / SEARCH / ?
-	PIC:CINELITE:CINEZONE:UPPER	-63 to 1094 / ? * -63(-6.3%) - 1094(109.4%)

20. NETWORK CONTROL

-	PIC:CINELITE:CINEZONE:LOWER	-73 to 1084 / ? * -73(-7.3%) - 1084(108.4%)
-	PIC:CINELITE:CINEZONE:LEVEL	-73 to 1094 / ? * -73(-7.3%) - 1094(109.4%)
-	PIC:FOCUS:PICTURE_MODE	FIT / REAL / X2 / ?
-	PIC:FOCUS:ASSIST	ON / OFF / ?
-	PIC:FOCUS:SENSITIVE	LOW / MIDDLE / HIGH / V_HIGH / U_HIGH / ?
-	PIC:FOCUS:PICTURE_LEVEL	OFF / EMBOSS / 25 / 50 / 75 / 100 / ?
-	PIC:FOCUS:EDGE_COLOR	WHITE / RED / GREEN / BLUE / ?
-	PIC:LINE_SELECT	ON / OFF / CINELITE / ?
-	PIC:LINE_NUMBER	-32768 to 32767 / ?
-	PIC:LINE_FIELD	FIELD1 / FIELD2 / FRAME / ?
-	PIC:SN:NOISE	STOP / START / ?
-	PIC:SN:CH	A1 / A2 / TRACK / OFF / ?
-	PIC:SN:SIGNAL	Y / G / B / R / ?
-	PIC:SN:LPF	0_404 / 0_323 / 0_269 / 0_202 / 0_101 / 0_0505 / THROUGH / ?
-	PIC:SN:SIZE	SMALL / LARGE / ?
-	PIC:SN:HPF	ON / OFF / ?
-	PIC:SN:BAR	ON / OFF / ?
-	PIC:SN:ALERT:UNIT	ON / OFF / ?
-	PIC:SN:ALERT:LEVEL	-80 to 0 / ?
RO	PIC:SN:DATA:DB	?
RO	PIC:SN:DATA:MV	?

• AUDIO KEY

r/w Limitation	Command	Parameter
WO	AUDIO	None
-	AUDIO:MODE	LISSAJOU / SURROUND / STATUS / LOUDNESS / ? * CH Mode : 8ch LISSAJOU / METER / STATUS / ? * CH Mode : 16ch
-	AUDIO:METER:RANGE	60DBFS / 90DBFS / MAG / ?
-	AUDIO:METER:RESPONSE	TRUEPEAK / PPM / VU / ?
-	AUDIO:METER:RESPONSE:PPM	PPM_I / PPM_II / ?
-	AUDIO:METER:RESPONSE:VU	TRUE / PPM_I / PPM_II / ?
-	AUDIO:METER:PEAK_HOLD	0.0 / 0.5 / 1.0 / 1.5 / 2.0 / 2.5 / 3.0 / 3.5 / 4.0 / 4.5 / 5.0 / HOLD / ?
-	AUDIO:METER:LEVEL_SET:OVER_LEVEL	-400 to 0 / ? * -40.0 (-400) - 0.0 (0)
-	AUDIO:METER:LEVEL_SET:WARNING_LEVEL	-400 to 0 / ? * -40.0 (-400) - 0.0 (0)
-	AUDIO:METER:LEVEL_SET:REF_LEVEL	-400 to 0 / ? * -40.0 (-400) - 0.0 (0)
-	AUDIO:METER:LEVEL_SET:LVL_VAL_DISP	INSTANTLY / PEAKHOLD / ?
WO	AUDIO:METER:LEVEL_SET:PEAK_HOLD_RESET	None
-	AUDIO:LISSAJOU:LISSAJOU:INTEN	-8 to 7 / ?
-	AUDIO:LISSAJOU:SCALE:INTEN	-8 to 7 / ?
-	AUDIO:LISSAJOU:DISPLAY	MULTI / SINGLE / ?
-	AUDIO:LISSAJOU:FORM	X_Y / MATRIX / ?
-	AUDIO:SURROUND:SURROUND:INTEN	-8 to 7 / ?
-	AUDIO:SURROUND:SCALE:INTEN	-8 to 7 / ?
-	AUDIO:SURROUND:5.1	NORMAL / PHANTOM / ?
-	AUDIO:SURROUND:AUTO_GAIN	ON / OFF / ?

20. NETWORK CONTROL

WO	AUDIO:DISP:LOG	None
-	AUDIO:STATUS:EVENT_LOG	START / STOP / ?
WO	AUDIO:STATUS:EVENT_LOG:CLEAR	None
-	AUDIO:STATUS:EVENT_LOG:MODE	OVER_WRT / STOP / ?
WO	AUDIO:DISP:CH_STATUS	None
-	AUDIO:STATUS:CH_STATUS:CH	CH1 / CH2 / CH3 / CH4 / CH5 / CH6 / CH7 / CH8 / CH9 / CH10 / CH11 / CH12 / CH13 / CH14 / CH15 / CH16 / A1 / A2 / A3 / A4 / A5 / A6 / A7 / A8 / A9 / A10 / A11 / A12 / A13 / A14 / A15 / A16 / B1 / B2 / B3 / B4 / B5 / B6 / B7 / B8 / B9 / B10 / B11 / B12 / B13 / B14 / B15 / B16 / C1 / C2 / C3 / C4 / C5 / C6 / C7 / C8 / C9 / C10 / C11 / C12 / C13 / C14 / C15 / C16 / D1 / D2 / D3 / D4 / D5 / D6 / D7 / D8 / D9 / D10 / D11 / D12 / D13 / D14 / D15 / D16 / ?
-	AUDIO:STATUS:CH_STATUS:ALIGN	LSB / MSB / ?
WO	AUDIO:DISP:USER_BIT	None
-	AUDIO:STATUS:USER_BIT:CH	CH1 / CH2 / CH3 / CH4 / CH5 / CH6 / CH7 / CH8 / CH9 / CH10 / CH11 / CH12 / CH13 / CH14 / CH15 / CH16 / A1 / A2 / A3 / A4 / A5 / A6 / A7 / A8 / A9 / A10 / A11 / A12 / A13 / A14 / A15 / A16 / B1 / B2 / B3 / B4 / B5 / B6 / B7 / B8 / B9 / B10 / B11 / B12 / B13 / B14 / B15 / B16 / C1 / C2 / C3 / C4 / C5 / C6 / C7 / C8 / C9 / C10 / C11 / C12 / C13 / C14 / C15 / C16 / D1 / D2 / D3 / D4 / D5 / D6 / D7 / D8 / D9 / D10 / D11 / D12 / D13 / D14 / D15 / D16 / ?
-	AUDIO:STATUS:USER_BIT:ALIGN	LSB / MSB / ?
WO	AUDIO:STATUS:ERROR_RESET	None
-	AUDIO:LOUD:PERIOD	2MIN / 10MIN / 30MIN / 1HOUR / 2HOUR / 6HOUR / 12HOUR / 24HOUR / ?
WO	AUDIO:LOUD:CHART_CLEAR	None
-	AUDIO:LOUD:MEASURE	START / STOP / ?
-	AUDIO:LOUD:MAG	OFF / ON / ?
-	AUDIO:DOLBY:META:PROGRAM	PRM1 / PRM2 / PRM3 / PRM4 / PRM5 / PRM6 / PRM7 / PRM8 / ?
-	AUDIO:DOLBY:DP_META:SUBSTREAM	SUB0 / SUB1 / SUB2 / SUB3 / SUB4 / SUB5 / SUB6 / SUB7 / ?
RO	AUDIO:DATA:STATUS:LEVEL:CH1	?
RO	AUDIO:DATA:STATUS:LEVEL:CH2	?
RO	AUDIO:DATA:STATUS:LEVEL:CH3	?
RO	AUDIO:DATA:STATUS:LEVEL:CH4	?
RO	AUDIO:DATA:STATUS:LEVEL:CH5	?
RO	AUDIO:DATA:STATUS:LEVEL:CH6	?
RO	AUDIO:DATA:STATUS:LEVEL:CH7	?
RO	AUDIO:DATA:STATUS:LEVEL:CH8	?
RO	AUDIO:DATA:STATUS:LEVEL:CH9	?
RO	AUDIO:DATA:STATUS:LEVEL:CH10	?
RO	AUDIO:DATA:STATUS:LEVEL:CH11	?
RO	AUDIO:DATA:STATUS:LEVEL:CH12	?
RO	AUDIO:DATA:STATUS:LEVEL:CH13	?
RO	AUDIO:DATA:STATUS:LEVEL:CH14	?
RO	AUDIO:DATA:STATUS:LEVEL:CH15	?
RO	AUDIO:DATA:STATUS:LEVEL:CH16	?

20. NETWORK CONTROL

• STATUS KEY

r/w Limitation	Command	Parameter
WO	STATUS	None
WO	STS:DUMP	None
WO	STS:EXT_REF	None
WO	STS:AVPHASE	None
WO	STS:ANCVIEW	None
WO	STS:ANCVIEW:DUMP	None
WO	STS:LOG	None
WO	STS:ANCPKT	None
WO	STS:ANCPKT:PKT_ANALYS:EDH	None
WO	STS:ANCPKT:PKT_ANALYS:PAYLOAD	None
WO	STS:ANCPKT:PKT_ANALYS:CTRL_PKT	None
WO	STS:ANCPKT:PKT_ANALYS:V_ANC:ARIB:CC	None
WO	STS:ANCPKT:PKT_ANALYS:V_ANC:ARIB:NETQ	None
WO	STS:ANCPKT:PKT_ANALYS:V_ANC:ARIB:TRIG	None
WO	STS:ANCPKT:PKT_ANALYS:V_ANC:ARIB:USER 1	None
WO	STS:ANCPKT:PKT_ANALYS:V_ANC:ARIB:USER 2	None
WO	STS:ANCPKT:PKT_ANALYS:V_ANC:SMPTE:60 8	None
WO	STS:ANCPKT:PKT_ANALYS:V_ANC:SMPTE:70 8	None
WO	STS:ANCPKT:PKT_ANALYS:V_ANC:SMPTE:AF D	None
WO	STS:ANCPKT:PKT_ANALYS:V_ANC:SMPTE:PR OG	None
WO	STS:ANCPKT:PKT_ANALYS:V_ANC:SMPTE:VBI	None
WO	STS:ANCPKT:PKT_ANALYS:V_ANC:SMPTE:SR LIVE	None
WO	STS:ANCPKT:PKT_ANALYS:V_ANC:SMPTE:SC TE104	None
WO	STS:ANCPKT:PKT_ANALYS:SEARCH	None
WO	STS:IP	None
WO	STS:IP:JITTER	None
WO	STS:IP:PTP	None
WO	STS:IP:INFO:SFP	None
WO	STS:IP:INFO:PHEADER	None
WO	STS:IP:PTP:DIFF	None
WO	STS:IP:WDLY	None
WO	STS:IP:JXS_STATUS	None
WO	STS:IP:JXS_HEADER	None
WO	STS:IP:FORMAT_CMP	None
WO	STS:ERROR:CLEAR	None
-	STS:LOG:LOG	START / STOP / ?
-	STS:LOG:MODE	OVER_WRT / STOP / ?
WO	STS:LOG:CLEAR	None
-	STS:SDI_ANALYS:DUMP:MODE	RUN / HOLD / ?
-	STS:SDI_ANALYS:DUMP:MODE_CAP	RUN / HOLD / FRMCAP / ?
-	STS:SDI_ANALYS:DUMP:OPE:JUMP	EAV / SAV / ?
-	STS:SDI_ANALYS:DUMP:DISPLAY	SERIAL / COMPO / BINARY / PICTURE / STREAM12 / STREAM1 / STREAM2 / S1_SERIAL / S1_COMPO / S1_BINARY / S2_SERIAL / S2_COMPO / S2_BINARY / ?

20. NETWORK CONTROL

-	STS:SDI_ANALYS:DUMP:LINK_SELECT	PICTURE / LINK_A / LINK_B / LINK_C / LINK_D / LINK_1 / LINK_2 / ?
WO	STS:SDI_ANALYS:EXT_REF:USER_REF	None
WO	STS:SDI_ANALYS:EXT_REF:DEFAULT	None
WO	STS:SDI_ANALYS:EXT_REF:SELECT	EXT / SDI / ?
-	STS:SDI_ANALYS:EXT_REF:TIMING	LEGACY / SERIAL / ?
-	STS:AV_PHASE:SCALE	50MS / 100MS / 500MS / 1000MS / 2500MS / ?
WO	STS:AVPHASE:REFRESH	None
-	STS:ANCVIEW:DUMP:HOLD	HOLD / 1S / 3S / ?
-	STS:ANCVIEW:DUMP:MODE	HEX / BINARY / ?
-	STS:ANCVIEW:DUMP:SAMPLE	0 to 258 / ?
-	STS:ANCPKT:PKT_ANALYS:EDH:DISP	TEXT / DUMP / ?
-	STS:ANCPKT:PKT_ANALYS:EDH:MODE	HEX / BINARY / ?
-	STS:ANCVIEW:STREAM	STREAM1 / STREAM2 / ?
-	STS:ANCPKT:PKT_ANALYS:PAYLOAD_ID:STREAM	STREAM1 / STREAM2 / ?
-	STS:ANCPKT:PKT_ANALYS:CTRL_PKT:DISPLAY	TEXT / DUMP / ?
-	STS:ANCPKT:PKT_ANALYS:CTRL_PKT:MODE	HEX / BINARY / ?
-	STS:ANCPKT:PKT_ANALYS:CTRL_PKT:GROUP	GROUP1 / GROUP2 / GROUP3 / GROUP4 / ?
-	STS:ANCPKT:PKT_ANALYS:CTRL_PKT:STREAM	STREAM1 / STREAM2 / ?
-	STS:ANCPKT:PKT_ANALYS:V_ANC:ARIB:CC:DISP	TEXT / DUMP / ?
-	STS:ANCPKT:PKT_ANALYS:V_ANC:ARIB:CC:TYPE	HD / SD / ANALOG / CELLULAR / ?
-	STS:ANCPKT:PKT_ANALYS:V_ANC:ARIB:CC:MODE	HEX / BINARY / ?
-	STS:ANCPKT:PKT_ANALYS:V_ANC:ARIB:CC:SMPL	0 to 258 / ?
-	STS:ANCPKT:PKT_ANALYS:V_ANC:ARIB:CC:STREAM	STREAM1 / STREAM2 / ?
-	STS:ANCPKT:PKT_ANALYS:V_ANC:ARIB:NETQ:DISP	TEXT / DUMP / Q_LOG / FORMAT / ?
-	STS:ANCPKT:PKT_ANALYS:V_ANC:ARIB:NETQ:MODE	HEX / BINARY / ?
-	STS:ANCPKT:PKT_ANALYS:V_ANC:ARIB:NETQ:SMPL	0 to 258 / ?
-	STS:ANCPKT:PKT_ANALYS:V_ANC:ARIB:NETQ:LOG	-50 to 50 / ?
-	STS:ANCPKT:PKT_ANALYS:V_ANC:ARIB:NETQ:STREAM	STREAM1 / STREAM2 / ?
WO	STS:ANCPKT:PKT_ANALYS:V_ANC:ARIB:NETQ:CLEAR	None
-	STS:ANCPKT:PKT_ANALYS:V_ANC:ARIB:TRIG:DISP	TEXT / DUMP / ?
-	STS:ANCPKT:PKT_ANALYS:V_ANC:ARIB:TRIG:MODE	HEX / BINARY / ?
-	STS:ANCPKT:PKT_ANALYS:V_ANC:ARIB:TRIG:SMPL	0 to 258 / ?
-	STS:ANCPKT:PKT_ANALYS:V_ANC:ARIB:TRIG:STREAM	STREAM1 / STREAM2 / ?
-	STS:ANCPKT:PKT_ANALYS:V_ANC:ARIB:USER1:MODE	HEX / BINARY / ?
-	STS:ANCPKT:PKT_ANALYS:V_ANC:ARIB:USER1:SMPL	0 to 258 / ?
-	STS:ANCPKT:PKT_ANALYS:V_ANC:ARIB:USER1:STREAM	STREAM1 / STREAM2 / ?

20. NETWORK CONTROL

-	STS:ANCPKT:PKT_ANALYS:V_ANC:ARIB:USER 2:MODE	HEX / BINARY / ?
-	STS:ANCPKT:PKT_ANALYS:V_ANC:ARIB:USER 2:SMPL	0 to 258 / ?
-	STS:ANCPKT:PKT_ANALYS:V_ANC:ARIB:USER 2:STREAM	STREAM1 / STREAM2 / ?
-	STS:ANCPKT:PKT_ANALYS:V_ANC:SMPTE:70 8:DISP	TEXT / DUMP / ?
-	STS:ANCPKT:PKT_ANALYS:V_ANC:SMPTE:70 8:MODE	HEX / BINARY / ?
-	STS:ANCPKT:PKT_ANALYS:V_ANC:SMPTE:70 8:SMPL	0 to 258 / ?
-	STS:ANCPKT:PKT_ANALYS:V_ANC:SMPTE:70 8:STREAM	STREAM1 / STREAM2 / ?
-	STS:ANCPKT:PKT_ANALYS:V_ANC:SMPTE:60 8:DISP	TEXT / DUMP / ?
-	STS:ANCPKT:PKT_ANALYS:V_ANC:SMPTE:60 8:MODE	HEX / BINARY / ?
-	STS:ANCPKT:PKT_ANALYS:V_ANC:SMPTE:60 8:SMPL	0 to 258 / ?
-	STS:ANCPKT:PKT_ANALYS:V_ANC:SMPTE:60 8:STREAM	STREAM1 / STREAM2 / ?
-	STS:ANCPKT:PKT_ANALYS:V_ANC:SMPTE:PR OG:STREAM	STREAM1 / STREAM2 / ?
-	STS:ANCPKT:PKT_ANALYS:V_ANC:SMPTE:VBI :STREAM	STREAM1 / STREAM2 / ?
-	STS:ANCPKT:PKT_ANALYS:V_ANC:SMPTE:AF D:DISP	TEXT / DUMP / ?
-	STS:ANCPKT:PKT_ANALYS:V_ANC:SMPTE:AF D:MODE	HEX / BINARY / ?
-	STS:ANCPKT:PKT_ANALYS:V_ANC:SMPTE:AF D:STREAM	STREAM1 / STREAM2 / ?
-	STS:ANCPKT:PKT_ANALYS:CSTM:ID_SET: DID	0 to 255 / ?
-	STS:ANCPKT:PKT_ANALYS:CSTM:ID_SET:SDI D	-1 to 255 / ?
-	STS:ANCPKT:PKT_ANALYS:CSTM:MODE	HEX / BINARY / ?
-	STS:ANCPKT:PKT_ANALYS:CSTM:YC	Y / C / ?
-	STS:ANCPKT:PKT_ANALYS:CSTM:STREAM	STREAM1 / STREAM2 / ?
WO	STS:ANCPKT:PKT_ANALYS:CSTM:ID_SET:SET	None
-	STS:ANCPKT:PKT_ANALYS:CSTM:SMPL	0 to 258 / ?
-	STS:ANCPKT:PKT_ANALYS:V_ANC:SMPTE:SR LIVE:DISP	TEXT / DUMP / ?
-	STS:ANCPKT:PKT_ANALYS:V_ANC:SMPTE:SR LIVE:MODE	HEX / BINARY / ?
-	STS:ANCPKT:PKT_ANALYS:V_ANC:SMPTE:SR LIVE:SMPL	0 - 258 / ?
-	STS:ANCPKT:PKT_ANALYS:V_ANC:SMPTE:SR LIVE:STREAM	STREAM1 / STREAM2 / ?
-	STS:ANCPKT:PKT_ANALYS:V_ANC:SMPTE:SC TE104:LOG:POS	-50 - 50 / ?
WO	STS:ANCPKT:PKT_ANALYS:V_ANC:SMPTE:SC TE104:LOG:CLEA	None
-	STS:ANCPKT:PKT_ANALYS:V_ANC:SMPTE:SC TE104:DISP	TEXT / DUMP / SPLICE / ?
-	STS:ANCPKT:PKT_ANALYS:V_ANC:SMPTE:SC TE104:MODE	HEX / BINARY / ?
-	STS:ANCPKT:PKT_ANALYS:V_ANC:SMPTE:SC TE104:LOG:LOGGING	START / STOP / ?

20. NETWORK CONTROL

-	STS:ANCPKT:PKT_ANALYS:V_ANC:SMPTE:SC TE104:SMPL	0 - 258 / ?
-	STS:ANCPKT:PKT_ANALYS:V_ANC:SMPTE:SC TE104:TEXT:DURATION	1 - 10 / ?
-	STS:ANCPKT:PKT_ANALYS:V_ANC:SMPTE:SC TE104:DUMP:DURATION	HOLD / 1S / 3S / ?
-	STS:ANCPKT:PKT_ANALYS:V_ANC:SMPTE:SC TE104:ID_VALUE	DEC / HEX / BOTH / ?
-	STS:ANCPKT:PKT_ANALYS:V_ANC:LINK_SELE CT	LINK_A / LINK_B / LINK_C / LINK_D / LINK_1 / LINK_2 / ?
-	STS:ERROR:SDI:COUNTER	SEC / FIELD / ?
-	STS:ERROR:SDI:TRS	ON / OFF / ?
-	STS:ERROR:SDI:HD_LINE	ON / OFF / ?
-	STS:ERROR:SDI:HD_CRC	ON / OFF / ?
-	STS:ERROR:SDI:SD_EDH	ON / OFF / ?
-	STS:ERROR:SDI:ILLEGAL_CODE	ON / OFF / ?
-	STS:ERROR:SDI:FREQ	ON / OFF / ?
-	STS:ERROR:SDI:CABLE	ON / OFF / ?
-	STS:ERROR:SDI:CABLE_12G	L_55UCHD / ?
-	STS:ERROR:SDI:CABLE_3G	LS_5CFB / 1694A / ?
-	STS:ERROR:SDI:CABLE_HD	LS_5CFB / 1694A / L_7CDH / ?
-	STS:ERROR:SDI:CABLE_SD	L_5C2V / 8281SD / 1505A / ?
-	STS:ERROR:SDI:CABLE_ERR_12G	10 to 80 / ?
-	STS:ERROR:SDI:CABLE_WAR_12G	10 to 80 / ?
-	STS:ERROR:SDI:CABLE_ERR_3G	10 to 100 / ?
-	STS:ERROR:SDI:CABLE_WAR_3G	10 to 100 / ?
-	STS:ERROR:SDI:CABLE_ERR_HD	10 to 130 / ?
-	STS:ERROR:SDI:CABLE_WAR_HD	10 to 130 / ?
-	STS:ERROR:SDI:CABLE_ERR_SD	50 to 200 / ?
-	STS:ERROR:SDI:CABLE_WAR_SD	50 to 200 / ?
-	STS:ERROR:ANC:PARITY	ON / OFF / ?
-	STS:ERROR:ANC:CHECKSUM	ON / OFF / ?
-	STS:ERROR:AUDIO:BCH	ON / OFF / ?
-	STS:ERROR:AUDIO:DBN	ON / OFF / ?
-	STS:ERROR:AUDIO:PARITY	ON / OFF / ?
-	STS:ERROR:AUDIO:INHIBIT	ON / OFF / ?
-	STS:ERROR:AUDIO:SAMPLE	ON / OFF / ?
-	STS:ERROR:GAMUT:LPF	OFF / HD1M_SD1M / HD28M_SD1M / ?
-	STS:ERROR:GAMUT	ON / OFF / ?
-	STS:ERROR:GAMUT:UPPER	908 to 1094 / ?
-	STS:ERROR:GAMUT:LOWER	-72 to 61 / ?
-	STS:ERROR:GAMUT:UPPER_MV	6356 to 7658 / ?
-	STS:ERROR:GAMUT:LOWER_MV	-504 to 427 / ?
-	STS:ERROR:GAMUT:AREA	0 to 50 / ?
-	STS:ERROR:GAMUT:DURATION	1 to 60 / ?
-	STS:ERROR:C_GAMUT	ON / OFF / ?
-	STS:ERROR:C_GAMUT:SETUP	0% / 7.5% / ?
-	STS:ERROR:C_GAMUT:UPPER	900 to 1350 / ?
-	STS:ERROR:C_GAMUT:LOWER	-400 to 200 / ?
-	STS:ERROR:C_GAMUT:UPPER_MV	6300 to 9640 / ?
-	STS:ERROR:C_GAMUT:LOWER_MV	-2860 to 1430 / ?
-	STS:ERROR:C_GAMUT:AREA	0 to 50 / ?
-	STS:ERROR:C_GAMUT:DURATION	1 to 60 / ?
-	STS:ERROR:FREEZE	ON / OFF / ?
-	STS:ERROR:FREEZE:UPPER	0 to 100 / ?
-	STS:ERROR:FREEZE:LOWER	0 to 100 / ?
-	STS:ERROR:FREEZE:LEFT	0 to 100 / ?

20. NETWORK CONTROL

-	STS:ERROR:FREEZE:RIGHT	0 to 100 / ?
-	STS:ERROR:FREEZE:DURATION	2 to 300 / ?
-	STS:ERROR:BLACK	ON / OFF / ?
-	STS:ERROR:BLACK:LEVEL	0 to 100 / ?
-	STS:ERROR:BLACK:AREA	1 to 100 / ?
-	STS:ERROR:BLACK:DURATION	1 to 300 / ?
-	STS:ERROR:LEVEL	ON / OFF / ?
-	STS:ERROR:LEVEL:LUMA:UPPER	-51 to 766 / ?
-	STS:ERROR:LEVEL:LUMA:LOWER	-51 to 766 / ?
-	STS:ERROR:LEVEL:CHROMA:UPPER	-400 to 399 / ?
-	STS:ERROR:LEVEL:CHROMA:LOWER	-400 to 399 / ?
-	STS:ERROR:GAMUT:UPPER	908 to 1094 / ?
-	STS:AVPHASE:4K_SQD	1A / 2B / 3C / 4D / ?
-	STS:AVPHASE:TOP	0 to 100 / ?
-	STS:AVPHASE:LEFT	0 to 99 / ?
-	STS:AVPHASE:RIGHT	0 to 99 / ?
-	STS:AVPHASE:VIDEO	25 to 100 / ?
-	STS:AVPHASE:AUDIO	-30 to 0 / ?
-	STS:AVPHASE:MSGATE	ON / OFF / ?
-	STS:AVPHASE:GATETIME	100 to 1500 / ?
-	STS:ANCPKT:PKT_ANALYS:V_ANC:ARIB:NETQ :BIT:Q1	ON / OFF / ?
-	STS:ANCPKT:PKT_ANALYS:V_ANC:ARIB:NETQ :BIT:Q2	ON / OFF / ?
-	STS:ANCPKT:PKT_ANALYS:V_ANC:ARIB:NETQ :BIT:Q3	ON / OFF / ?
-	STS:ANCPKT:PKT_ANALYS:V_ANC:ARIB:NETQ :BIT:Q4	ON / OFF / ?
-	STS:ANCPKT:PKT_ANALYS:V_ANC:ARIB:NETQ :BIT:Q5	ON / OFF / ?
-	STS:ANCPKT:PKT_ANALYS:V_ANC:ARIB:NETQ :BIT:Q6	ON / OFF / ?
-	STS:ANCPKT:PKT_ANALYS:V_ANC:ARIB:NETQ :BIT:Q7	ON / OFF / ?
-	STS:ANCPKT:PKT_ANALYS:V_ANC:ARIB:NETQ :BIT:Q8	ON / OFF / ?
-	STS:ANCPKT:PKT_ANALYS:V_ANC:ARIB:NETQ :BIT:Q9	ON / OFF / ?
-	STS:ANCPKT:PKT_ANALYS:V_ANC:ARIB:NETQ :BIT:Q10	ON / OFF / ?
-	STS:ANCPKT:PKT_ANALYS:V_ANC:ARIB:NETQ :BIT:Q11	ON / OFF / ?
-	STS:ANCPKT:PKT_ANALYS:V_ANC:ARIB:NETQ :BIT:Q12	ON / OFF / ?
-	STS:ANCPKT:PKT_ANALYS:V_ANC:ARIB:NETQ :BIT:Q13	ON / OFF / ?
-	STS:ANCPKT:PKT_ANALYS:V_ANC:ARIB:NETQ :BIT:Q14	ON / OFF / ?
-	STS:ANCPKT:PKT_ANALYS:V_ANC:ARIB:NETQ :BIT:Q15	ON / OFF / ?
-	STS:ANCPKT:PKT_ANALYS:V_ANC:ARIB:NETQ :BIT:Q16	ON / OFF / ?
-	STS:ANCPKT:PKT_ANALYS:V_ANC:ARIB:NETQ :BIT:Q17	ON / OFF / ?
-	STS:ANCPKT:PKT_ANALYS:V_ANC:ARIB:NETQ :BIT:Q18	ON / OFF / ?
-	STS:ANCPKT:PKT_ANALYS:V_ANC:ARIB:NETQ :BIT:Q19	ON / OFF / ?

20. NETWORK CONTROL

-	STS:ANCPKT:PKT_ANALYS:V_ANC:ARIB:NETQ :BIT:Q20	ON / OFF / ?
-	STS:ANCPKT:PKT_ANALYS:V_ANC:ARIB:NETQ :BIT:Q21	ON / OFF / ?
-	STS:ANCPKT:PKT_ANALYS:V_ANC:ARIB:NETQ :BIT:Q22	ON / OFF / ?
-	STS:ANCPKT:PKT_ANALYS:V_ANC:ARIB:NETQ :BIT:Q23	ON / OFF / ?
-	STS:ANCPKT:PKT_ANALYS:V_ANC:ARIB:NETQ :BIT:Q24	ON / OFF / ?
-	STS:ANCPKT:PKT_ANALYS:V_ANC:ARIB:NETQ :BIT:Q25	ON / OFF / ?
-	STS:ANCPKT:PKT_ANALYS:V_ANC:ARIB:NETQ :BIT:Q26	ON / OFF / ?
-	STS:ANCPKT:PKT_ANALYS:V_ANC:ARIB:NETQ :BIT:Q27	ON / OFF / ?
-	STS:ANCPKT:PKT_ANALYS:V_ANC:ARIB:NETQ :BIT:Q28	ON / OFF / ?
-	STS:ANCPKT:PKT_ANALYS:V_ANC:ARIB:NETQ :BIT:Q29	ON / OFF / ?
-	STS:ANCPKT:PKT_ANALYS:V_ANC:ARIB:NETQ :BIT:Q30	ON / OFF / ?
-	STS:ANCPKT:PKT_ANALYS:V_ANC:ARIB:NETQ :BIT:Q31	ON / OFF / ?
-	STS:ANCPKT:PKT_ANALYS:V_ANC:ARIB:NETQ :BIT:Q32	ON / OFF / ?
-	STS:ANCPKT:PKT_ANALYS:V_ANC:ARIB:NETQ :BIT:S1	ON / OFF / ?
-	STS:ANCPKT:PKT_ANALYS:V_ANC:ARIB:NETQ :BIT:S2	ON / OFF / ?
-	STS:ANCPKT:PKT_ANALYS:V_ANC:ARIB:NETQ :BIT:S3	ON / OFF / ?
-	STS:ANCPKT:PKT_ANALYS:V_ANC:ARIB:NETQ :BIT:S4	ON / OFF / ?
-	STS:ANCPKT:PKT_ANALYS:V_ANC:ARIB:NETQ :BIT:S5	ON / OFF / ?
-	STS:ANCPKT:PKT_ANALYS:V_ANC:ARIB:NETQ :BIT:S6	ON / OFF / ?
-	STS:ANCPKT:PKT_ANALYS:V_ANC:ARIB:NETQ :BIT:S7	ON / OFF / ?
-	STS:ANCPKT:PKT_ANALYS:V_ANC:ARIB:NETQ :BIT:S8	ON / OFF / ?
-	STS:ANCPKT:PKT_ANALYS:V_ANC:ARIB:NETQ :BIT:S9	ON / OFF / ?
-	STS:ANCPKT:PKT_ANALYS:V_ANC:ARIB:NETQ :BIT:S10	ON / OFF / ?
-	STS:ANCPKT:PKT_ANALYS:V_ANC:ARIB:NETQ :BIT:S11	ON / OFF / ?
-	STS:ANCPKT:PKT_ANALYS:V_ANC:ARIB:NETQ :BIT:S12	ON / OFF / ?
-	STS:ANCPKT:PKT_ANALYS:V_ANC:ARIB:NETQ :BIT:S13	ON / OFF / ?
-	STS:ANCPKT:PKT_ANALYS:V_ANC:ARIB:NETQ :BIT:S14	ON / OFF / ?
-	STS:ANCPKT:PKT_ANALYS:V_ANC:ARIB:NETQ :BIT:S15	ON / OFF / ?
-	STS:ANCPKT:PKT_ANALYS:V_ANC:ARIB:NETQ :BIT:S16	ON / OFF / ?

20. NETWORK CONTROL

RO	STS:DATA:SIGNAL_A	?
RO	STS:DATA:SIGNAL_B	?
RO	STS:DATA:SIGNAL_C	?
RO	STS:DATA:SIGNAL_D	?
RO	STS:DATA:LINK_A	?
RO	STS:DATA:LINK_B	?
RO	STS:DATA:LINK_C	?
RO	STS:DATA:LINK_D	?
RO	STS:DATA:FORMAT_A	?
RO	STS:DATA:FORMAT_B	?
RO	STS:DATA:FORMAT_C	?
RO	STS:DATA:FORMAT_D	?
RO	STS:DATA:AUDIO_A	?
RO	STS:DATA:AUDIO_B	?
RO	STS:DATA:AUDIO_C	?
RO	STS:DATA:AUDIO_D	?
RO	STS:DATA:EXTREF_A	?
RO	STS:DATA:EXTREF_STAT_A	?
RO	STS:DATA:EXTREF_HTIME_A	?
RO	STS:DATA:EXTREF_HPIX_A	?
RO	STS:DATA:EXTREF_VLINE_A	?
RO	STS:DATA:EXTREF_TOTAL_A	?
RO	STS:DATA:EXTREF_B	?
RO	STS:DATA:EXTREF_STAT_B	?
RO	STS:DATA:EXTREF_HTIME_B	?
RO	STS:DATA:EXTREF_HPIX_B	?
RO	STS:DATA:EXTREF_VLINE_B	?
RO	STS:DATA:EXTREF_TOTAL_B	?
RO	STS:DATA:EXTREF_C	?
RO	STS:DATA:EXTREF_STAT_C	?
RO	STS:DATA:EXTREF_HTIME_C	?
RO	STS:DATA:EXTREF_HPIX_C	?
RO	STS:DATA:EXTREF_VLINE_C	?
RO	STS:DATA:EXTREF_TOTAL_C	?
RO	STS:DATA:EXTREF_D	?
RO	STS:DATA:EXTREF_STAT_D	?
RO	STS:DATA:EXTREF_HTIME_D	?
RO	STS:DATA:EXTREF_HPIX_D	?
RO	STS:DATA:EXTREF_VLINE_D	?
RO	STS:DATA:EXTREF_TOTAL_D	?
RO	STS:DATA:ANC:AUDIO_CTRL1	?
RO	STS:DATA:ANC:AUDIO_CTRL2	?
RO	STS:DATA:ANC:EDH	?
RO	STS:DATA:ANC:LTC1	?
RO	STS:DATA:ANC:LTC2	?
RO	STS:DATA:ANC:VLTC1	?
RO	STS:DATA:ANC:VLTC2	?
RO	STS:DATA:ANC:PAYLOAD1	?
RO	STS:DATA:ANC:PAYLOAD2	?
RO	STS:DATA:ANC:EIA:708_708	?
RO	STS:DATA:ANC:EIA:708_608	?
RO	STS:DATA:ANC:EIA:608	?
RO	STS:DATA:ANC:PROGRAM	?
RO	STS:DATA:ANC:BROADCAST	?
RO	STS:DATA:ANC:VBI	?
RO	STS:DATA:ANC:AFD1	?
RO	STS:DATA:ANC:AFD2	?

20. NETWORK CONTROL

RO	STS:DATA:ANC:JPN_CC1	?
RO	STS:DATA:ANC:JPN_CC2	?
RO	STS:DATA:ANC:JPN_CC3	?
RO	STS:DATA:ANC:NETQ1	?
RO	STS:DATA:ANC:NETQ2	?
RO	STS:DATA:ANC:TRIGGER	?
RO	STS:DATA:ANC:USER1	?
RO	STS:DATA:ANC:USER2	?
RO	STS:DATA:ANC:PKT:PAYLOAD	?
RO	STS:DATA:ANC:PKT:ARIB:NETQ:STATION	?
RO	STS:DATA:ANC:PKT:ARIB:NETQ:VCURR	?
RO	STS:DATA:ANC:PKT:ARIB:NETQ:VNEXT	?
RO	STS:DATA:ANC:PKT:ARIB:NETQ:ACURR	?
RO	STS:DATA:ANC:PKT:ARIB:NETQ:ANEXT	?
RO	STS:DATA:ANC:PKT:ARIB:NETQ:DCURR	?
RO	STS:DATA:ANC:PKT:ARIB:NETQ:DNEXT	?
RO	STS:DATA:ANC:PKT:SMPTE:AFD:CODE	?
RO	STS:DATA:ANC:PKT:SMPTE:AFD:FRAME	?
RO	STS:DATA:ANC:PKT:SMPTE:AFD:BAR:FLG	?
RO	STS:DATA:ANC:PKT:SMPTE:AFD:BAR:VAL1	?
RO	STS:DATA:ANC:PKT:SMPTE:AFD:BAR:VAL2	?
RO	STS:DATA:ANC:FREQ	?
RO	STS:DATA:ANC:FREQ_A	?
RO	STS:DATA:ANC:FREQ_B	?
RO	STS:DATA:ANC:FREQ_C	?
RO	STS:DATA:ANC:FREQ_D	?
RO	STS:DATA:AV_PHASE:MS:CH1	?
RO	STS:DATA:AV_PHASE:MS:CH2	?
RO	STS:DATA:AV_PHASE:MS:CH3	?
RO	STS:DATA:AV_PHASE:MS:CH4	?
RO	STS:DATA:AV_PHASE:MS:CH5	?
RO	STS:DATA:AV_PHASE:MS:CH6	?
RO	STS:DATA:AV_PHASE:MS:CH7	?
RO	STS:DATA:AV_PHASE:MS:CH8	?
RO	STS:DATA:AV_PHASE:MS:CH9	?
RO	STS:DATA:AV_PHASE:MS:CH10	?
RO	STS:DATA:AV_PHASE:MS:CH11	?
RO	STS:DATA:AV_PHASE:MS:CH12	?
RO	STS:DATA:AV_PHASE:MS:CH13	?
RO	STS:DATA:AV_PHASE:MS:CH14	?
RO	STS:DATA:AV_PHASE:MS:CH15	?
RO	STS:DATA:AV_PHASE:FRM:CH1	?
RO	STS:DATA:AV_PHASE:FRM:CH2	?
RO	STS:DATA:AV_PHASE:FRM:CH3	?
RO	STS:DATA:AV_PHASE:FRM:CH4	?
RO	STS:DATA:AV_PHASE:FRM:CH5	?
RO	STS:DATA:AV_PHASE:FRM:CH6	?
RO	STS:DATA:AV_PHASE:FRM:CH7	?
RO	STS:DATA:AV_PHASE:FRM:CH8	?
RO	STS:DATA:AV_PHASE:FRM:CH9	?
RO	STS:DATA:AV_PHASE:FRM:CH10	?
RO	STS:DATA:AV_PHASE:FRM:CH11	?
RO	STS:DATA:AV_PHASE:FRM:CH12	?
RO	STS:DATA:AV_PHASE:FRM:CH13	?
RO	STS:DATA:AV_PHASE:FRM:CH14	?
RO	STS:DATA:AV_PHASE:FRM:CH15	?

20. NETWORK CONTROL

RO	STS:DATA:AV_PHASE:FRM:CH16	?
RO	STS:DATA:ANC:AUDIO_CTRL1_A	?
RO	STS:DATA:ANC:AUDIO_CTRL1_B	?
RO	STS:DATA:ANC:AUDIO_CTRL1_C	?
RO	STS:DATA:ANC:AUDIO_CTRL1_D	?
RO	STS:DATA:ANC:AUDIO_CTRL2_A	?
RO	STS:DATA:ANC:AUDIO_CTRL2_B	?
RO	STS:DATA:ANC:AUDIO_CTRL2_C	?
RO	STS:DATA:ANC:AUDIO_CTRL2_D	?
RO	STS:DATA:ANC:EDH_A	?
RO	STS:DATA:ANC:EDH_B	?
RO	STS:DATA:ANC:EDH_C	?
RO	STS:DATA:ANC:EDH_D	?
RO	STS:DATA:ANC:LTC1_A	?
RO	STS:DATA:ANC:LTC1_B	?
RO	STS:DATA:ANC:LTC1_C	?
RO	STS:DATA:ANC:LTC1_D	?
RO	STS:DATA:ANC:LTC2_A	?
RO	STS:DATA:ANC:LTC2_B	?
RO	STS:DATA:ANC:LTC2_C	?
RO	STS:DATA:ANC:LTC2_D	?
RO	STS:DATA:ANC:VLTC1_A	?
RO	STS:DATA:ANC:VLTC1_B	?
RO	STS:DATA:ANC:VLTC1_C	?
RO	STS:DATA:ANC:VLTC1_D	?
RO	STS:DATA:ANC:VLTC2_A	?
RO	STS:DATA:ANC:VLTC2_B	?
RO	STS:DATA:ANC:VLTC2_C	?
RO	STS:DATA:ANC:VLTC2_D	?
RO	STS:DATA:ANC:PAYLOAD1_A	?
RO	STS:DATA:ANC:PAYLOAD1_B	?
RO	STS:DATA:ANC:PAYLOAD1_C	?
RO	STS:DATA:ANC:PAYLOAD1_D	?
RO	STS:DATA:ANC:PAYLOAD2_A	?
RO	STS:DATA:ANC:PAYLOAD2_B	?
RO	STS:DATA:ANC:PAYLOAD2_C	?
RO	STS:DATA:ANC:PAYLOAD2_D	?
RO	STS:DATA:ANC:EIA:708_708_A	?
RO	STS:DATA:ANC:EIA:708_708_B	?
RO	STS:DATA:ANC:EIA:708_708_C	?
RO	STS:DATA:ANC:EIA:708_708_D	?
RO	STS:DATA:ANC:EIA:708_608_A	?
RO	STS:DATA:ANC:EIA:708_608_B	?
RO	STS:DATA:ANC:EIA:708_608_C	?
RO	STS:DATA:ANC:EIA:708_608_D	?
RO	STS:DATA:ANC:EIA:608_A	?
RO	STS:DATA:ANC:EIA:608_B	?
RO	STS:DATA:ANC:EIA:608_C	?
RO	STS:DATA:ANC:EIA:608_D	?
RO	STS:DATA:ANC:PROGRAM_A	?
RO	STS:DATA:ANC:PROGRAM_B	?
RO	STS:DATA:ANC:PROGRAM_C	?
RO	STS:DATA:ANC:PROGRAM_D	?
RO	STS:DATA:ANC:BROADCAST_A	?
RO	STS:DATA:ANC:BROADCAST_B	?
RO	STS:DATA:ANC:BROADCAST_C	?
RO	STS:DATA:ANC:BROADCAST_D	?

20. NETWORK CONTROL

RO	STS:DATA:ANC:VBI_A	?
RO	STS:DATA:ANC:VBI_B	?
RO	STS:DATA:ANC:VBI_C	?
RO	STS:DATA:ANC:VBI_D	?
RO	STS:DATA:ANC:AFD1_A	?
RO	STS:DATA:ANC:AFD1_B	?
RO	STS:DATA:ANC:AFD1_C	?
RO	STS:DATA:ANC:AFD1_D	?
RO	STS:DATA:ANC:AFD2_A	?
RO	STS:DATA:ANC:AFD2_B	?
RO	STS:DATA:ANC:AFD2_C	?
RO	STS:DATA:ANC:AFD2_D	?
RO	STS:DATA:ANC:JPN_CC1_A	?
RO	STS:DATA:ANC:JPN_CC1_B	?
RO	STS:DATA:ANC:JPN_CC1_C	?
RO	STS:DATA:ANC:JPN_CC1_D	?
RO	STS:DATA:ANC:JPN_CC2_A	?
RO	STS:DATA:ANC:JPN_CC2_B	?
RO	STS:DATA:ANC:JPN_CC2_C	?
RO	STS:DATA:ANC:JPN_CC2_D	?
RO	STS:DATA:ANC:JPN_CC3_A	?
RO	STS:DATA:ANC:JPN_CC3_B	?
RO	STS:DATA:ANC:JPN_CC3_C	?
RO	STS:DATA:ANC:JPN_CC3_D	?
RO	STS:DATA:ANC:NETQ1_A	?
RO	STS:DATA:ANC:NETQ1_B	?
RO	STS:DATA:ANC:NETQ1_C	?
RO	STS:DATA:ANC:NETQ1_D	?
RO	STS:DATA:ANC:NETQ2_A	?
RO	STS:DATA:ANC:NETQ2_B	?
RO	STS:DATA:ANC:NETQ2_C	?
RO	STS:DATA:ANC:NETQ2_D	?
RO	STS:DATA:ANC:TRIGGER_A	?
RO	STS:DATA:ANC:TRIGGER_B	?
RO	STS:DATA:ANC:TRIGGER_C	?
RO	STS:DATA:ANC:TRIGGER_D	?
RO	STS:DATA:ANC:USER1_A	?
RO	STS:DATA:ANC:USER1_B	?
RO	STS:DATA:ANC:USER1_C	?
RO	STS:DATA:ANC:USER1_D	?
RO	STS:DATA:ANC:USER2_A	?
RO	STS:DATA:ANC:USER2_B	?
RO	STS:DATA:ANC:USER2_C	?
RO	STS:DATA:ANC:USER2_D	?
RO	STS:DATA:ANC:PKT:PAYLOAD_A	?
RO	STS:DATA:ANC:PKT:PAYLOAD_B	?
RO	STS:DATA:ANC:PKT:PAYLOAD_C	?
RO	STS:DATA:ANC:PKT:PAYLOAD_D	?
RO	STS:DATA:ANC:PKT:ARIB:NETQ:STATION_A	?
RO	STS:DATA:ANC:PKT:ARIB:NETQ:STATION_B	?
RO	STS:DATA:ANC:PKT:ARIB:NETQ:STATION_C	?
RO	STS:DATA:ANC:PKT:ARIB:NETQ:STATION_D	?
RO	STS:DATA:ANC:PKT:ARIB:NETQ:VCURR_A	?
RO	STS:DATA:ANC:PKT:ARIB:NETQ:VCURR_B	?
RO	STS:DATA:ANC:PKT:ARIB:NETQ:VCURR_C	?
RO	STS:DATA:ANC:PKT:ARIB:NETQ:VCURR_D	?
RO	STS:DATA:ANC:PKT:ARIB:NETQ:VNEXT_A	?

20. NETWORK CONTROL

RO	STS:DATA:ANC:PKT:ARIB:NETQ:VNEXT_B	?
RO	STS:DATA:ANC:PKT:ARIB:NETQ:VNEXT_C	?
RO	STS:DATA:ANC:PKT:ARIB:NETQ:VNEXT_D	?
RO	STS:DATA:ANC:PKT:ARIB:NETQ:ACURR_A	?
RO	STS:DATA:ANC:PKT:ARIB:NETQ:ACURR_B	?
RO	STS:DATA:ANC:PKT:ARIB:NETQ:ACURR_C	?
RO	STS:DATA:ANC:PKT:ARIB:NETQ:ACURR_D	?
RO	STS:DATA:ANC:PKT:ARIB:NETQ:ANEXT_A	?
RO	STS:DATA:ANC:PKT:ARIB:NETQ:ANEXT_B	?
RO	STS:DATA:ANC:PKT:ARIB:NETQ:ANEXT_C	?
RO	STS:DATA:ANC:PKT:ARIB:NETQ:ANEXT_D	?
RO	STS:DATA:ANC:PKT:ARIB:NETQ:DCURR_A	?
RO	STS:DATA:ANC:PKT:ARIB:NETQ:DCURR_B	?
RO	STS:DATA:ANC:PKT:ARIB:NETQ:DCURR_C	?
RO	STS:DATA:ANC:PKT:ARIB:NETQ:DCURR_D	?
RO	STS:DATA:ANC:PKT:ARIB:NETQ:DNEXT_A	?
RO	STS:DATA:ANC:PKT:ARIB:NETQ:DNEXT_B	?
RO	STS:DATA:ANC:PKT:ARIB:NETQ:DNEXT_C	?
RO	STS:DATA:ANC:PKT:ARIB:NETQ:DNEXT_D	?
RO	STS:DATA:ANC:PKT:SMPTE:AFD:CODE_A	?
RO	STS:DATA:ANC:PKT:SMPTE:AFD:CODE_B	?
RO	STS:DATA:ANC:PKT:SMPTE:AFD:CODE_C	?
RO	STS:DATA:ANC:PKT:SMPTE:AFD:CODE_D	?
RO	STS:DATA:ANC:PKT:SMPTE:AFD:FRAME_A	?
RO	STS:DATA:ANC:PKT:SMPTE:AFD:FRAME_B	?
RO	STS:DATA:ANC:PKT:SMPTE:AFD:FRAME_C	?
RO	STS:DATA:ANC:PKT:SMPTE:AFD:FRAME_D	?
RO	STS:DATA:ANC:PKT:SMPTE:AFD:BAR:FLG_A	?
RO	STS:DATA:ANC:PKT:SMPTE:AFD:BAR:FLG_B	?
RO	STS:DATA:ANC:PKT:SMPTE:AFD:BAR:FLG_C	?
RO	STS:DATA:ANC:PKT:SMPTE:AFD:BAR:FLG_D	?
RO	STS:DATA:ANC:PKT:SMPTE:AFD:BAR:VAL1_A	?
RO	STS:DATA:ANC:PKT:SMPTE:AFD:BAR:VAL1_B	?
RO	STS:DATA:ANC:PKT:SMPTE:AFD:BAR:VAL1_C	?
RO	STS:DATA:ANC:PKT:SMPTE:AFD:BAR:VAL1_D	?
RO	STS:DATA:ANC:PKT:SMPTE:AFD:BAR:VAL2_A	?
RO	STS:DATA:ANC:PKT:SMPTE:AFD:BAR:VAL2_B	?
RO	STS:DATA:ANC:PKT:SMPTE:AFD:BAR:VAL2_C	?
RO	STS:DATA:ANC:PKT:SMPTE:AFD:BAR:VAL2_D	?
-	STS:IP:JITTER:PERIOD	2MIN / 10MIN / 30MIN / 1HOUR / 2HOUR / 6HOUR / 12HOUR / 24HOUR / 72HOUR / ?
WO	STS:IP:JITTER:CLEAR	None
-	STS:IP:PTP:PERIOD	2MIN / 10MIN / 30MIN / 1HOUR / 2HOUR / 6HOUR / 12HOUR / 24HOUR / 72HOUR / ?
WO	STS:IP:PTP:CLEAR	None
-	STS:IP:PTP:MODE	DELAY_TIME / TIME_OFFSET / ?
-	STS:IP:PTP:SCALE	0.5 to 10.5 / ?
-	STS:IP:CHART:PERIOD	2MIN / 10MIN / 30MIN / 1HOUR / 2HOUR / 6HOUR / 12HOUR / 24HOUR / 72HOUR / ?

20. NETWORK CONTROL

WO	STS:IP:CHART:CLEAR	None
-	STS:IP:WDLY:PERIOD	2MIN / 10MIN / 30MIN / 1HOUR / 2HOUR / 6HOUR / 12HOUR / 24HOUR / 72HOUR / ?
WO	STS:IP:WDLY:CLEAR	None
-	STS:IP:PTP_DIFF:PERIOD	2MIN / 10MIN / 30MIN / 1HOUR / 2HOUR / 6HOUR / 12HOUR / 24HOUR / 72HOUR / ?
WO	STS:IP:PTP_DIFF:CLEAR	None
-	STS:IP:PTP_DIFF:MODE:VIDEO	ON / OFF / ?
-	STS:IP:PTP_DIFF:MODE:AUDIO	ON / OFF / ?
-	STS:IP:PTP_DIFF:MODE:ANC	ON / OFF / ?
-	STS:IP:INFO:PHEADER:MODE	MAC_IP / UDP_RTP / PAYLOAD / ?
-	STS:IP:INFO:PHEADER:MEASURE	RUN / STOP / ?
-	STS:IP:BUFFER:PERIOD	2MIN / 10MIN / 30MIN / 1HOUR / 2HOUR / 6HOUR / 12HOUR / 24HOUR / 72HOUR / ?
WO	STS:IP:BUFFER:CLEAR	None
-	STS:IP:BUFFER:MODE	CMAX / VRX / ?
WO	STS:IP:JXS:STATUS:CLEAR	None
-	STS:IP:JXS:HEADER_MODE	VIDEO_SUPPORT / PROFILE / BUFFER / METADATA / TRANSPORT / IMAGE / COLOR / ?

• EYE KEY

r/w Limitation	Command	Parameter
WO	EYE	None
-	EYE:MODE	EYE / JITTER / ?
-	EYE:EYE:INTEN	-128 to 127 / ?
-	EYE:EYE:COLOR	WHITE / YELLOW / CYAN / GREEN / MAGENTA / RED / BLUE / ?
-	EYE:EYE:SCALE:INTEN	-8 to 7 / ?
-	EYE:EYE:SCALE:COLOR	WHITE / YELLOW / CYAN / GREEN / MAGENTA / RED / BLUE / ?
-	EYE:EYE:SETUP:GAIN:VAR	CAL / VAR / ?
-	EYE:EYE:SETUP:GAIN:VAL	50 to 200 / ?
-	EYE:EYE:SETUP:SWEEP	2UI / 4UI / 16UI / ?
-	EYE:EYE:SETUP:FILTER	100KHZ / 10KHZ / 1KHZ / 100HZ / 10HZ / TIMING / ALIGNMENT / ?
-	EYE:EYE:SETUP:TILE	SINGLE / DUAL / ?
-	EYE:EYE:SETUP:CORSOR	ON / OFF / ?
WO	EYE:EYE:SETUP:CORSOR:RESET	None
-	EYE:EYE:SETUP:CORSOR:XY_SEL	X / Y / TR_TF / ?
-	EYE:JIT:INTEN	-128 to 127 / ?
-	EYE:JIT:COLOR	WHITE / YELLOW / CYAN / GREEN / MAGENTA / RED / BLUE / ?
-	EYE:JIT:SCALE:INTEN	-8 to 7 / ?
-	EYE:JIT:SCALE:COLOR	WHITE / YELLOW / CYAN / GREEN / MAGENTA / RED / BLUE / ?
-	EYE:JIT:SETUP:GAIN_SWEEP:MAG	X1 / X2 / X8 / ?
-	EYE:JIT:SETUP:GAIN_SWEEP:12G:MAG	X1 / X2 / X4 / X16 / ?
-	EYE:JIT:SETUP:GAIN_SWEEP:SWEEP	1H / 2H / 1V / 2V / ?
-	EYE:JIT:SETUP:FILTER	100kHZ / 10KHZ / 1KHZ / 100HZ / 10HZ / TIMING / ALIGNMENT / ?
-	EYE:JIT:SETUP:PEAK_HOLD	ON / OFF / ?
WO	EYE:JIT:SETUP:PEAK_CLEAR	None
-	EYE:JIT:SETUP:TILE	SINGLE / DUAL / ?
-	EYE:JIT:SETUP:CORSOR	ON / OFF / ?
WO	EYE:JIT:SETUP:CORSOR:RESET	None
-	EYE:JIT:SETUP:CORSOR:XY_SEL	X / Y / ?

20. NETWORK CONTROL

WO	EYE:ERROR:SETUP:COMPLETE	None
-	EYE:ERROR:12G:AMP	ON / OFF / ?
-	EYE:ERROR:12G:AMP:UPPER	80 to 140 / ?
-	EYE:ERROR:12G:AMP:LOWER	40 to 100 / ?
-	EYE:ERROR:12G:RISE	ON / OFF / ?
-	EYE:ERROR:12G:RISE:MAX	40 to 110 / ?
-	EYE:ERROR:12G:FALL	ON / OFF / ?
-	EYE:ERROR:12G:FALL:MAX	40 to 110 / ?
-	EYE:ERROR:12G:DELTA	ON / OFF / ?
-	EYE:ERROR:12G:DELTA:MAX	40 to 110 / ?
-	EYE:ERROR:12G:TIMING_JIT	ON / OFF / ?
-	EYE:ERROR:12G:TIMING_JIT:MAX	10 to 200 / ?
-	EYE:ERROR:12G:CURRENT_JIT	ON / OFF / ?
-	EYE:ERROR:12G:CURRENT_JIT:MAX	10 to 200 / ?
-	EYE:ERROR:12G:OVERSHOOT_RISE	ON / OFF / ?
-	EYE:ERROR:12G:OVERSHOOT_RISE:MAX	0 to 200 / ?
-	EYE:ERROR:12G:OVERSHOOT_FALL	ON / OFF / ?
-	EYE:ERROR:12G:OVERSHOOT_FALL:MAX	0 to 200 / ?
-	EYE:ERROR:6G:AMP	ON / OFF / ?
-	EYE:ERROR:6G:AMP:UPPER	80 to 140 / ?
-	EYE:ERROR:6G:AMP:LOWER	40 to 100 / ?
-	EYE:ERROR:6G:RISE	ON / OFF / ?
-	EYE:ERROR:6G:RISE:MAX	40 to 110 / ?
-	EYE:ERROR:6G:FALL	ON / OFF / ?
-	EYE:ERROR:6G:FALL:MAX	40 to 110 / ?
-	EYE:ERROR:6G:DELTA	ON / OFF / ?
-	EYE:ERROR:6G:DELTA:MAX	40 to 110 / ?
-	EYE:ERROR:6G:TIMING_JIT	ON / OFF / ?
-	EYE:ERROR:6G:TIMING_JIT:MAX	10 to 200 / ?
-	EYE:ERROR:6G:CURRENT_JIT	ON / OFF / ?
-	EYE:ERROR:6G:CURRENT_JIT:MAX	10 to 200 / ?
-	EYE:ERROR:6G:OVERSHOOT_RISE	ON / OFF / ?
-	EYE:ERROR:6G:OVERSHOOT_RISE:MAX	0 to 200 / ?
-	EYE:ERROR:6G:OVERSHOOT_FALL	ON / OFF / ?
-	EYE:ERROR:6G:OVERSHOOT_FALL:MAX	0 to 200 / ?
-	EYE:ERROR:3G:AMP	ON / OFF / ?
-	EYE:ERROR:3G:AMP:UPPER	80 to 140 / ?
-	EYE:ERROR:3G:AMP:LOWER	40 to 100 / ?
-	EYE:ERROR:3G:RISE	ON / OFF / ?
-	EYE:ERROR:3G:RISE:MAX	40 to 140 / ?
-	EYE:ERROR:3G:FALL	ON / OFF / ?
-	EYE:ERROR:3G:FALL:MAX	40 to 140 / ?
-	EYE:ERROR:3G:DELTA	ON / OFF / ?
-	EYE:ERROR:3G:DELTA:MAX	40 to 140 / ?
-	EYE:ERROR:3G:TIMING_JIT	ON / OFF / ?
-	EYE:ERROR:3G:TIMING_JIT:MAX	10 to 200 / ?
-	EYE:ERROR:3G:CURRENT_JIT	ON / OFF / ?
-	EYE:ERROR:3G:CURRENT_JIT:MAX	10 to 200 / ?
-	EYE:ERROR:3G:OVERSHOOT_RISE	ON / OFF / ?
-	EYE:ERROR:3G:OVERSHOOT_RISE:MAX	0 to 200 / ?
-	EYE:ERROR:3G:OVERSHOOT_FALL	ON / OFF / ?
-	EYE:ERROR:3G:OVERSHOOT_FALL:MAX	0 to 200 / ?
-	EYE:ERROR:HD:AMP	ON / OFF / ?
-	EYE:ERROR:HD:AMP:UPPER	80 to 140 / ?
-	EYE:ERROR:HD:AMP:LOWER	40 to 100 / ?
-	EYE:ERROR:HD:RISE	ON / OFF / ?
-	EYE:ERROR:HD:RISE:MAX	40 to 140 / ?

20. NETWORK CONTROL

-	EYE:ERROR:HD:FALL	ON / OFF / ?
-	EYE:ERROR:HD:FALL:MAX	40 to 140 / ?
-	EYE:ERROR:HD:DELTA	ON / OFF / ?
-	EYE:ERROR:HD:DELTA:MAX	40 to 140 / ?
-	EYE:ERROR:HD:TIMING_JIT	ON / OFF / ?
-	EYE:ERROR:HD:TIMING_JIT:MAX	10 to 200 / ?
-	EYE:ERROR:HD:CURRENT_JIT	ON / OFF / ?
-	EYE:ERROR:HD:CURRENT_JIT:MAX	10 to 200 / ?
-	EYE:ERROR:HD:OVERSHOOT_RISE	ON / OFF / ?
-	EYE:ERROR:HD:OVERSHOOT_RISE:MAX	0 to 200 / ?
-	EYE:ERROR:HD:OVERSHOOT_FALL	ON / OFF / ?
-	EYE:ERROR:HD:OVERSHOOT_FALL:MAX	0 to 200 / ?
-	EYE:ERROR:SD:AMP	ON / OFF / ?
-	EYE:ERROR:SD:AMP:UPPER	80 to 140 / ?
-	EYE:ERROR:SD:AMP:LOWER	40 to 100 / ?
-	EYE:ERROR:SD:RISE	ON / OFF / ?
-	EYE:ERROR:SD:RISE:MAX	40 to 140 / ?
-	EYE:ERROR:SD:FALL	ON / OFF / ?
-	EYE:ERROR:SD:FALL:MAX	40 to 140 / ?
-	EYE:ERROR:SD:DELTA	ON / OFF / ?
-	EYE:ERROR:SD:DELTA:MAX	40 to 140 / ?
-	EYE:ERROR:SD:TIMING_JIT	ON / OFF / ?
-	EYE:ERROR:SD:TIMING_JIT:MAX	10 to 200 / ?
-	EYE:ERROR:SD:CURRENT_JIT	ON / OFF / ?
-	EYE:ERROR:SD:CURRENT_JIT:MAX	10 to 200 / ?
-	EYE:ERROR:SD:OVERSHOOT_RISE	ON / OFF / ?
-	EYE:ERROR:SD:OVERSHOOT_RISE:MAX	0 to 200 / ?
-	EYE:ERROR:SD:OVERSHOOT_FALL	ON / OFF / ?
-	EYE:ERROR:SD:OVERSHOOT_FALL:MAX	0 to 200 / ?
RO	EYE:TRIGGER	RUN / STOP / ?
RO	EYE:DATA:AMP	?
RO	EYE:DATA:TR	?
RO	EYE:DATA:TF	?
RO	EYE:DATA:TJ	?
RO	EYE:DATA:CJ	?
RO	EYE:DATA:OR	?
RO	EYE:DATA:OF	?
RO	EYE:DATA:PEAK:TJ	?
RO	EYE:DATA:PEAK:JIT	?
-	EYE:HISTOGRAM	ON / OFF / ?
-	EYE:HISTOGRAM:INTEN	-8 to 7 / ?
-	EYE:HISTOGRAM:COLOR	WHITE / YELLOW / CYAN / GREEN / MAGENTA / RED / BLUE / ?

20.3 FTP

The files that are generated by the instrument can be transferred to a PC connected to the same network.

If you are using the LV7600, read LV5600 and lv5600 as LV7600 and lv7600.

20.3.1 How to Use

1. Configure the Ethernet settings on the NETWORK tab of the SYS menu.

Set the IP address, and set FTP to ON.

[See also] 7.2.8, "Configuring the Server"

SYS → F•2 SYSTEM SETUP → F•2 PREV TAB or F•3 NEXT TAB →



Figure 20-3 NETWORK tab

2. Press F•1 COMPLETE.
3. Connect the instrument's Ethernet port to the external network device.
4. On the PC, start an FTP client.

On Windows 7, on the taskbar, click Start, and then click Run. Type "FTP" and the IP address that you set in step 1. Then, click OK.

5. Type the login name and password.

The login name and password are "LV5600". Use uppercase for all characters. When the login name and password are entered correctly, "ftp>" appears.

```

Connected to *.*.*.*.*.*.
220 Welcome to LV5600 FTP service.
User (*.*.*.*.*.*:(none)): LV5600 ..... User name
331 Please specify the password.
Password: LV5600 ..... Password (The password is not actually
displayed.)
230 Login successful
ftp>
    
```

20. NETWORK CONTROL

6. Enter FTP commands.

Enter commands while referring to sections 20.3.2, "How to Enter Commands," and 20.3.3, "FTP Commands." You must generate files using the TELNET "MAKE" command before you use FTP commands.

To end an FTP session, type "bye" in lowercase letters.

```
ftp> bye
```

20.3.2 How to Enter Commands

The command syntax is explained below.

```
ftp> [Command] + [Space] + [Parameter 1] + [Space] + [Parameter 2]
```

Examples of how to enter commands are shown below.

```
ftp> get log.txt D:¥log.txt..... Transfer the event log file to the PC.
200 PORT Command successful ..... Return value
:
ftp>
```

20.3.3 FTP Commands

Table 20-2 FTP commands

Command	Parameter 1	Parameter 2
get	log.txt	Storage location on the PC and file name (example: D:¥log.txt)
	dump.txt	Storage location on the PC and file name (example: D:¥dump.txt)
	cap_bmp.bmp	Storage location on the PC and file name (example: D:¥capture.bmp)
	cap_bsg.bsg	Storage location on the PC and file name (example: D:¥capture.bsg)
	cap_frm_a.frm	Storage location on the PC and file name (example: D:¥capture_a.frm)
	cap_dpx_a.dpx	Storage location on the PC and file name (example: D:¥capture_a.dpx)
	cap_tif_a.tif	Storage location on the PC and file name (example: D:¥capture_a.tif)
	cap_frm_b.frm	Storage location on the PC and file name (example: D:¥capture_b.frm)
	cap_dpx_b.dpx	Storage location on the PC and file name (example: D:¥capture_b.dpx)
	cap_tif_b.tif	Storage location on the PC and file name (example: D:¥capture_b.tif)
	cap_frm_c.frm	Storage location on the PC and file name (example: D:¥capture_c.frm)
	cap_dpx_c.dpx	Storage location on the PC and file name (example: D:¥capture_c.dpx)
	cap_tif_c.tif	Storage location on the PC and file name (example: D:¥capture_c.tif)
	cap_frm_d.frm	Storage location on the PC and file name (example: D:¥capture_d.frm)
	cap_dpx_d.dpx	Storage location on the PC and file name (example: D:¥capture_d.dpx)
	cap_tif_d.tif	Storage location on the PC and file name (example: D:¥capture_d.tif)
	lv5600.my	Storage location on the PC and file name (example: D:¥lv5600.my)
	ip_stream01.sdp	Storage location on the PC and file name (example: D:¥ip_stream01.sdp)
	ip_stream02.sdp	Storage location on the PC and file name (example: D:¥ip_stream02.sdp)
	ip_stream03.sdp	Storage location on the PC and file name (example: D:¥ip_stream03.sdp)
ip_stream04.sdp	Storage location on the PC and file name (example: D:¥ip_stream04.sdp)	
ip_stream05.sdp	Storage location on the PC and file name (example: D:¥ip_stream05.sdp)	

20. NETWORK CONTROL

Command	Parameter 1	Parameter 2
	ip_stream06.sdp	Storage location on the PC and file name (example: D:¥ip_stream06.sdp)
	ip_stream07.sdp	Storage location on the PC and file name (example: D:¥ip_stream07.sdp)
	ip_stream08.sdp	Storage location on the PC and file name (example: D:¥ip_stream08.sdp)
	ip_stream09.sdp	Storage location on the PC and file name (example: D:¥ip_stream09.sdp)
	ip_stream10.sdp	Storage location on the PC and file name (example: D:¥ip_stream10.sdp)
	ip_stream11.sdp	Storage location on the PC and file name (example: D:¥ip_stream11.sdp)
	ip_stream12.sdp	Storage location on the PC and file name (example: D:¥ip_stream12.sdp)
	ip_stream13.sdp	Storage location on the PC and file name (example: D:¥ip_stream13.sdp)
	ip_stream14.sdp	Storage location on the PC and file name (example: D:¥ip_stream14.sdp)
	ip_stream15.sdp	Storage location on the PC and file name (example: D:¥ip_stream15.sdp)
	ip_stream16.sdp	Storage location on the PC and file name (example: D:¥ip_stream16.sdp)
	ip_stream17.sdp	Storage location on the PC and file name (example: D:¥ip_stream17.sdp)
	ip_stream18.sdp	Storage location on the PC and file name (example: D:¥ip_stream18.sdp)
	ip_stream19.sdp	Storage location on the PC and file name (example: D:¥ip_stream19.sdp)
	ip_stream20.sdp	Storage location on the PC and file name (example: D:¥ip_stream20.sdp)
	ip_stream21.sdp	Storage location on the PC and file name (example: D:¥ip_stream21.sdp)
	ip_stream22.sdp	Storage location on the PC and file name (example: D:¥ip_stream22.sdp)
	ip_stream23.sdp	Storage location on the PC and file name (example: D:¥ip_stream23.sdp)
	ip_stream24.sdp	Storage location on the PC and file name (example: D:¥ip_stream24.sdp)
	ip_sender_video1.sdp	Storage location on the PC and file name (example: D:¥ip_sender_video1.sdp)
	ip_sender_audio.sdp	Storage location on the PC and file name (example: D:¥ip_sender_audio.sdp)
	ip_sender_anc.sdp	Storage location on the PC and file name (example: D:¥ ip_sender_anc.sdp)

20.4 HTTP

You can use this feature to control the instrument from a web browser on a PC in the same manner as you would control the instrument from the panel.

20.4.1 Operating Environment

The following web browsers have been confirmed to work.

- Internet Explorer Ver.11
- Google Chrome Ver.46

20.4.2 Notes

- Enable JavaScript and pop-up on the WEB browser in advance.
- After you press a key in the web browser interface, wait for the screen to update before you perform the next operation. The screen cannot redraw fast enough to keep up with consecutive key presses. In this situation, a completely gray screen may be displayed temporarily. (After a few seconds the screen will return to normal.)
- When you are using the HTTP server feature, perform as few panel operations on the instrument as possible. The instrument's internal processing load increases when it is redrawing the web browser screen, so there is a lag of 1 to 2 seconds from the time that you perform panel operations on the instrument to the time that the operations are actually carried out.
- The number of simultaneous PC connections to the HTTP server feature is 1. Multiple connections are not supported.
- User layout and enhanced layout features (SER26) cannot be used.

20.4.3 How to Use

1. Configure the Ethernet settings on the NETWORK tab of the SYS menu.

Set the IP address, and set HTTP to ON.

[See also] 7.2.8, "Configuring the Server"

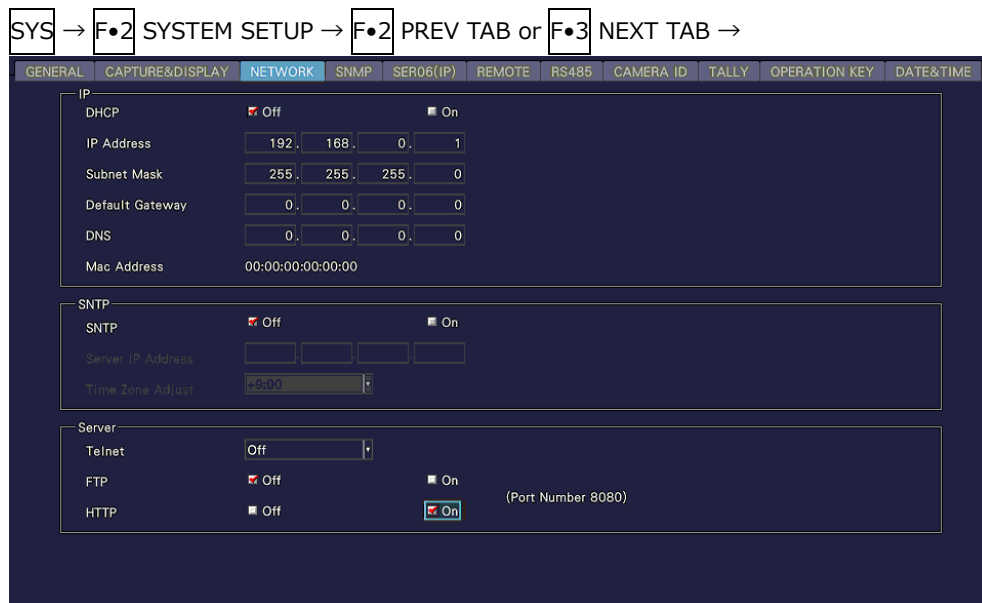

Figure 20-4 NETWORK tab

20. NETWORK CONTROL

2. Press **F•1** COMPLETE.
3. Connect the instrument's Ethernet port to the external network device.
4. Start the web browser on your PC.
5. In the address box, enter "http://(the IP address that you set in step 1):8080."

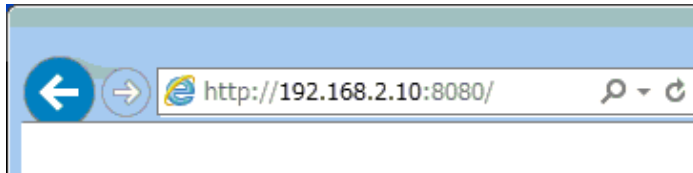

Figure 20-5 Entering the IP address

6. From the HTTP server menu, select the display mode.

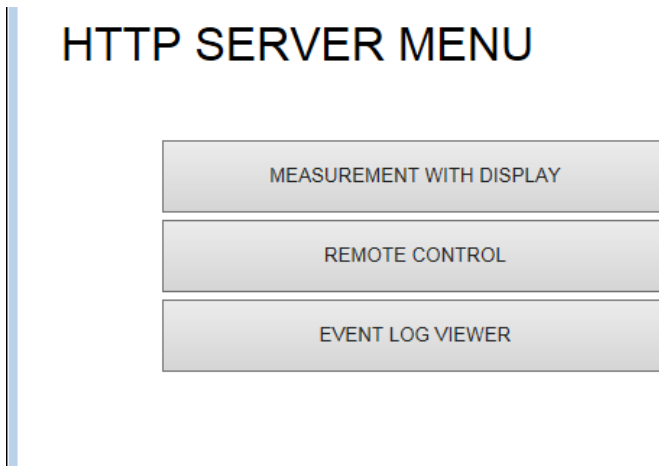

Figure 20-6 HTTP server menu

Table 20-3 HTTP server menu description

Name	Description
MEASUREMENT WITH DISPLAY	A measurement screen and control buttons are displayed.
REMOTE CONTROL	Only control buttons are displayed. Select this mode when you want to control the instrument while looking at its screen.
EVENT LOG VIEWER	The event log is displayed. The log can also be saved in text format.

If you select MEASUREMENT WITH DISPLAY, the measurement screen appears, but responses to operations can take 4 to 10 seconds, and auto display updating is every 10 seconds.

If you select REMOTE CONTROL, a screen is not displayed, but the response time is reduced to 2 to 3 seconds.

Select the mode that meets your needs.

20.4.4 MEASUREMENT WITH DISPLAY

On the MEASUREMENT WITH DISPLAY tab, the instrument is controlled by clicking the control buttons.

The measurement screen is updated automatically at a given interval. It may take some time for the screen to be updated after you click a control button depending on the operating environment.



Figure 20-7 MEASUREMENT WITH DISPLAY

20. NETWORK CONTROL

Table 20-4 MEASUREMENT WITH DISPLAY description

No.	Name	Description
1	Tabs	Switches the display mode.
2	Measurement screen	This is the measurement screen. You cannot click this area. Set the tab menu using the F•D button.
3	Function key menu	Click to control the menu. Double-click slowly to change to the next item. Use the F•D button to change values.
4	SELECT	This button corresponds to holding down the MULTI key (layout selection).
5	MEM	This button corresponds to holding down the PRESET key (preset registration).
6	V POS H POS F•D	">" and "<" correspond to turning the knob to the right and left respectively. The number of "<" or ">" corresponds to the amount of change. The V•POS, H•POS, and F•D buttons correspond to the behavior performed when the corresponding button is pressed.
7	CAPTURE	Click this button after selecting the file format (BMP, JPG, or PCAP) to display a measurement screen in a separate window. Right-click the screen and click "Save picture as" to save the image in the specified file format. If this method does not work, use "DOWNLOAD" in the upper left of the screen to save it.
8	MENU CLEAR	Hides the menu. To show it again, click the function menu area.
9	SCREEN REFRESH	Set the screen's auto update interval to FAST, NORMAL, or SLOW.

20.4.5 REMOTE CONTROL

On the REMOTE CONTROL tab, the instrument is controlled by clicking the control buttons. As this mode does not display a measurement screen, select this mode when you want to control the instrument while looking at its screen.

The descriptions of the control buttons are the same as in section 20.4.4, "MEASUREMENT WITH DISPLAY."

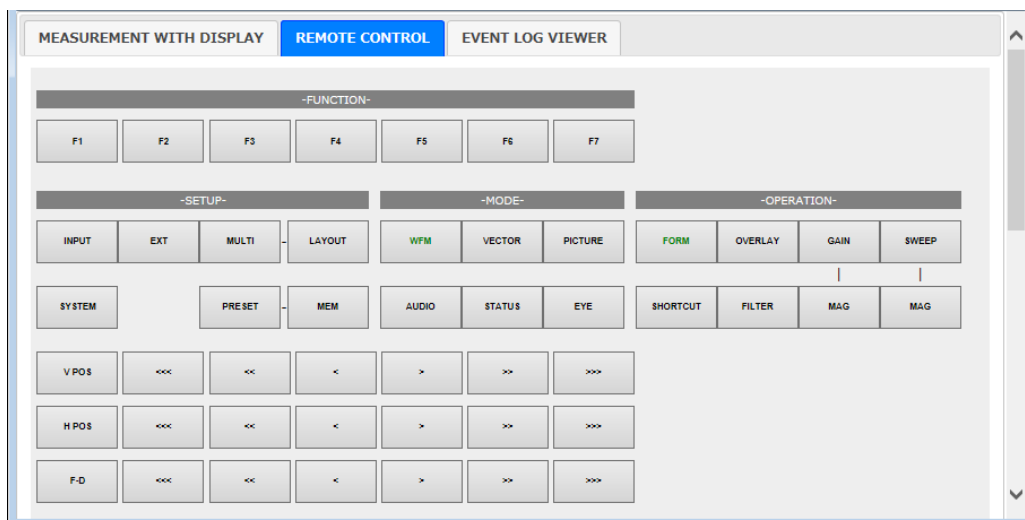

Figure 20-8 REMOTE CONTROL

20. NETWORK CONTROL

20.4.6 EVENT LOG VIEWER

The EVENT LOG VIEWER tab displays the event log of the status display. Nothing is displayed at first. You can display the log entries by setting LOG VIEWER to UPDATE. The screen is updated automatically at a given interval. Set LOG to START on the EVENT LOG menu in advance. [See also] 16.4, "Configuring Event Log Settings"

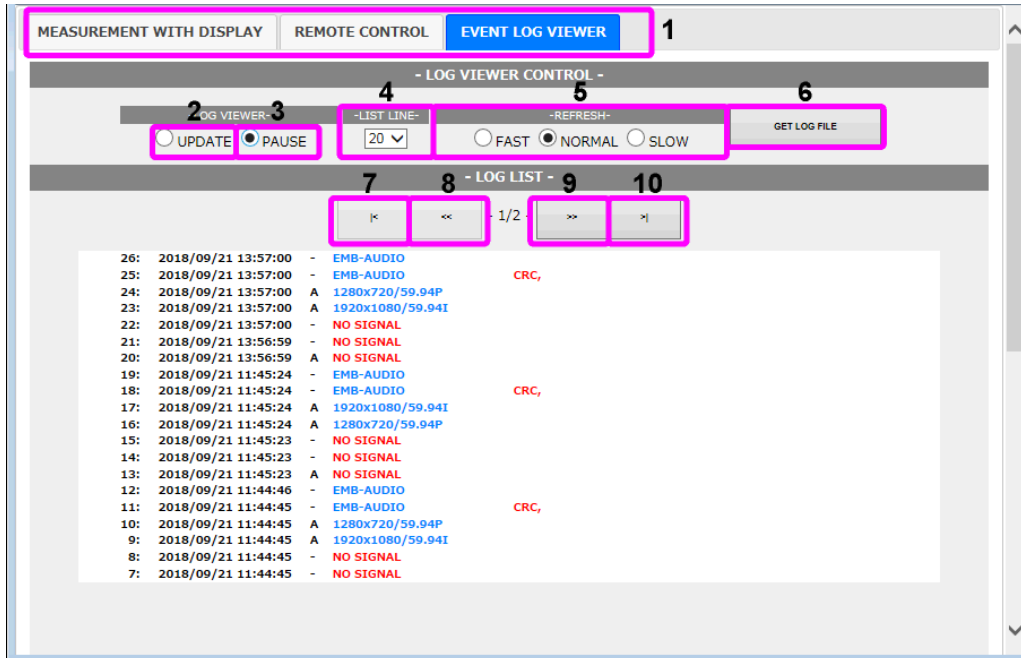

Figure 20-9 EVENT LOG VIEWER

Table 20-5 EVENT LOG VIEWER description

No.	Name	Description
1	Tabs	Switches the display mode.
2	UPDATE	The screen is updated automatically. LOG LIST shows the latest log.
3	PAUSE	The screen is not automatically updated. Past log entries can be displayed in LOG LIST.
4	LIST LINE	Select the number of entries to display on a screen from 10 to 50 (in 5 steps).
5	REFRESH	Set the screen's auto update interval to FAST, NORMAL, or SLOW.
6	GET LOG FILE	The event log is displayed in a separate window. From the File menu, choose Save As to save the log in text format.
7	<	The latest log entries are displayed when LOG VIEWER is set to PAUSE.
8	<<	The next newer log page appears when LOG VIEWER is set to PAUSE.
9	>>	The next older log page appears when LOG VIEWER is set to PAUSE.
10	>	The oldest log entries are displayed when LOG VIEWER is set to PAUSE.

20.5 SNMP

By using SNMP (Simple Network Management Protocol), you can control the instrument from SNMP managers. Additionally, you can notify the SNMP managers of errors that the instrument generates.

This product supports SNMPv2.

If you are using the LV7600, read LV5600 and lv5600 as LV7600 and lv7600.

The descriptions in this section follow the instrument or the option menu structure. Some of the descriptions do not apply depending on the installed options or the current settings.

20.5.1 SMI Definitions

IMPORTS

MODULE-IDENTITY, OBJECT-TYPE, NOTIFICATION-TYPE, enterprises
FROM SNMPv2-SMI

DisplayString

FROM SNMPv2-TC

OBJECT-GROUP, MODULE-COMPLIANCE

FROM SNMPv2-CONF;

20.5.2 How to Use

1. Configure the SNMP settings on the SNMP tab of the SYS menu.

Set the IP Address, and set SNMP Client to ReadWrite and SNMP Trap to ON.

[See also] 7.2.9, "Configuring SNMP"

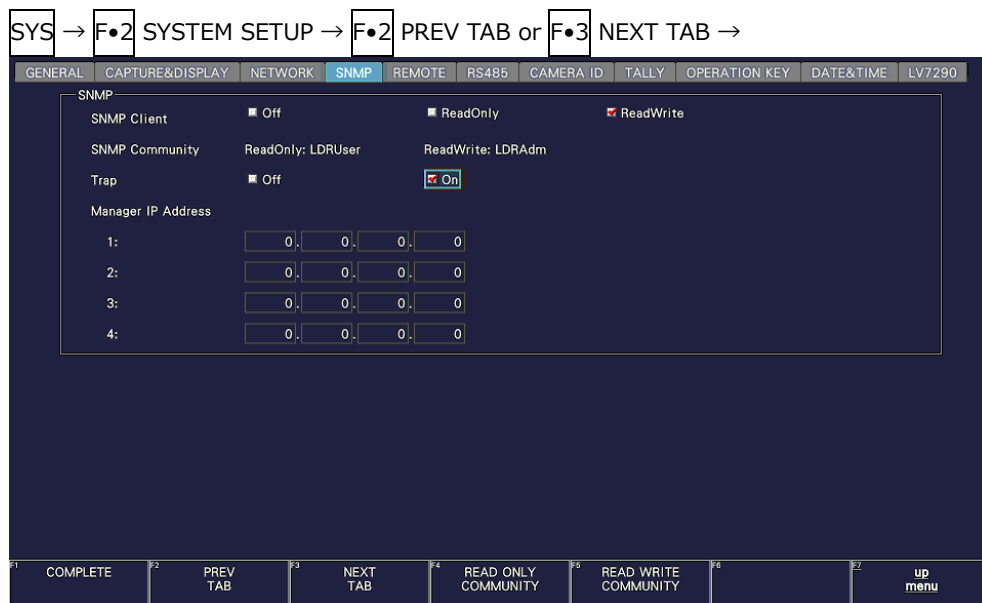

Figure 20-10 SNMP tab

2. Press F•1 COMPLETE.
3. Connect the instrument's Ethernet port to the external network device.
4. On the PC, start an SNMP manager.

You must provide the SNMP manager yourself.

The default community names are shown below.

20. NETWORK CONTROL

ReadOnly and ReadWrite can be changed with the SNMP Community parameter.

[See also] SNMP Community → 7.2.9, "Configuring SNMP"

ReadOnly: LDRUser
ReadWrite: LDRAdm
TRAP: LDRUser

5. Check that the SNMP managers can perform GET and SET operations.
6. From the SNMP manager, set the following MIB items to the SNMP managers' IP addresses.

Up to four locations can be set.

[IP address of TRAP transmission destination 1]

```
1.3.6.1.4.1.leader(20111).lv5600(40).lv5600ST1(1).l40trapTBL(9).l40trapIpTBL(1).l40trapIp1TBL(1).l40trapManagerIp1(1).0
```

[IP address of TRAP transmission destination 2]

```
1.3.6.1.4.1.leader(20111).lv5600(40).lv5600ST1(1).l40trapTBL(9).l40trapIpTBL(1).l40trapIp2TBL(2).l40trapManagerIp1(1).0
```

[IP address of TRAP transmission destination 3]

```
1.3.6.1.4.1.leader(20111).lv5600(40).lv5600ST1(1).l40trapTBL(9).l40trapIpTBL(1).l40trapIp3TBL(3).l40trapManagerIp1(1).0
```

[IP address of TRAP transmission destination 4]

```
1.3.6.1.4.1.leader(20111).lv5600(40).lv5600ST1(1).l40trapTBL(9).l40trapIpTBL(1).l40trapIp4TBL(4).l40trapManagerIp1(1).0
```

7. Enable the TRAP transmission destinations.

To alleviate communication load, disable the transmission destinations that you are not using. This setting is disabled by factory default.

[Enable (1) or disable (2) TRAP transmission destination 1]

```
1.3.6.1.4.1.leader(20111).lv5600(40).lv5600ST1(1).l40trapTBL(9).l40trapIpTBL(1).l40trapIp1TBL(1).l40trapManagerIp1Act(2).0
```

[Enable (1) or disable (2) TRAP transmission destination 2]

```
1.3.6.1.4.1.leader(20111).lv5600(40).lv5600ST1(1).l40trapTBL(9).l40trapIpTBL(1).l40trapIp2TBL(2).l40trapManagerIp1Act(2).0
```

[Enable (1) or disable (2) TRAP transmission destination 3]

```
1.3.6.1.4.1.leader(20111).lv5600(40).lv5600ST1(1).l40trapTBL(9).l40trapIpTBL(1).l40trapIp3TBL(3).l40trapManagerIp1Act(2).0
```

[Enable (1) or disable (2) TRAP transmission destination 4]

```
1.3.6.1.4.1.leader(20111).lv5600(40).lv5600ST1(1).l40trapTBL(9).l40trapIpTBL(1).l40trapIp4TBL(4).l40trapManagerIp1Act(2).0
```

8. Restart the LV5600.
9. When the LV5600 starts, it transmits the standard TRAP "coldStart(0)." Check that this is received by the SNMP managers.

20. NETWORK CONTROL

20.5.3 Standard MIBs

The instrument uses the following standard MIBs:

- RFC1213 (MIB- II)
- RFC1354 (IP Forwarding Table MIB)

In the tables, "ACCESS" and "SUPPORT" indicate the following:

Indication	Description	
ACCESS	R/O	Information that can be read from the SNMP managers.
	R/W	Information that can be read and written from the SNMP managers
SUPPORT	Y	Supports the MIB object as defined by the standard.
	R/O	Reading and writing are possible according to the standard, but the instrument only supports reading.
	N	Not supported.

- system group

MIB	OID	SYNTAX	ACCESS	SUPPORT
sysDescr	system.1	DisplayString	R/O	Y
sysObjectID	system.2	ObjectID	R/O	Y
sysUpTime	system.3	TimeTicks	R/O	Y
sysContact	system.4	DisplayString	R/W	Y
sysName	system.5	DisplayString	R/O	R/O
sysLocation	system.6	DisplayString	R/W	Y
sysServices	system.7	INTEGER	R/O	Y

- interface group

MIB	OID	SYNTAX	ACCESS	SUPPORT
ifNumber	interfaces.1	INTEGER	R/O	Y
ifTable	interfaces.2	Aggregate	-	-
ifEntry	ifTable.1	Aggregate	-	-
ifIndex	ifEntry.1	INTEGER	R/O	Y
ifDescr	ifEntry.2	DisplayString	R/O	Y
ifType	ifEntry.3	INTEGER	R/O	Y
ifMtu	ifEntry.4	INTEGER	R/O	Y
ifSpeed	ifEntry.5	Gauge	R/O	Y
ifPhysAddress	ifEntry.6	OctetString	R/O	Y
ifAdminStatus	ifEntry.7	INTEGER	R/O	R/O
ifOperStatus	ifEntry.8	INTEGER	R/O	Y
ifLastChange	ifEntry.9	TimeTicks	R/O	Y
ifInOctets	ifEntry.10	Counter	R/O	Y
ifInUcastPkts	ifEntry.11	Counter	R/O	Y
ifInNUcastPkts	ifEntry.12	Counter	R/O	Y
ifInDiscards	ifEntry.13	Counter	R/O	Y
ifInErrors	ifEntry.14	Counter	R/O	Y
ifInUnknownProtos	ifEntry.15	Counter	R/O	Y
ifOutOctets	ifEntry.16	Counter	R/O	Y
ifOutUcastPkts	ifEntry.17	Counter	R/O	Y
ifOutNUcastPkts	ifEntry.18	Counter	R/O	Y
ifOutDiscards	ifEntry.19	Counter	R/O	Y
ifOutErrors	ifEntry.20	Counter	R/O	Y
ifOutQLen	ifEntry.21	Gauge	R/O	Y
ifSpecific	ifEntry.22	ObjectID	R/O	Y

20. NETWORK CONTROL

• ip group

MIB	OID	SYNTAX	ACCESS	SUPPORT
ipForwarding	ip.1	INTEGER	R/O	Y
ipDefaultTTL	ip.2	INTEGER	R/O	R/O
ipInReceives	ip.3	Counter	R/O	Y
ipInHdrErrors	ip.4	Counter	R/O	Y
ipInAddrErrors	ip.5	Counter	R/O	Y
ipForwDatagrams	ip.6	Counter	R/O	Y
ipInUnknownProtos	ip.7	Counter	R/O	Y
ipInDiscards	ip.8	Counter	R/O	Y
ipInDelivers	ip.9	Counter	R/O	Y
ipOutRequests	ip.10	Counter	R/O	Y
ipOutDiscards	ip.11	Counter	R/O	Y
ipOutNoRoutes	ip.12	Counter	R/O	Y
ipReasmTimeout	ip.13	INTEGER	R/O	Y
ipReasmReqds	ip.14	Counter	R/O	Y
ipReasmOKs	ip.15	Counter	R/O	Y
ipReasmFails	ip.16	Counter	R/O	Y
ipFragOKs	ip.17	Counter	R/O	Y
ipFragFails	ip.18	Counter	R/O	Y
ipFragCreates	ip.19	Counter	R/O	Y
ipAddrTable	ip.20	Aggregate	-	-
ipAddrEntry	ipAddrTable.1		R/O	Y
ipAdEntAddr	ipAddrEntry.1	IpAddress	R/O	Y
ipAdEntIfIndex	ipAddrEntry.2	INTEGER	R/O	Y
ipAdEntNetMask	ipAddrEntry.3	IpAddress	R/O	Y
ipAdEntBcastAddr	ipAddrEntry.4	INTEGER	R/O	Y
ipAdEntReasmMaxSize	ipAddrEntry.5	INTEGER	R/O	Y
ipRouteTable	ip.21	Aggregate	-	-
ipRouteEntry	ipRouteTable.1	Aggregate	-	-
ipRouteDest	ipRouteEntry.1	IpAddress	R/O	R/O
ipRouteIfIndex	ipRouteEntry.2	INTEGER	R/O	R/O
ipRouteMetric1	ipRouteEntry.3	INTEGER	R/O	R/O
ipRouteMetric2	ipRouteEntry.4	INTEGER	R/O	R/O
ipRouteMetric3	ipRouteEntry.5	INTEGER	R/O	R/O
ipRouteMetric4	ipRouteEntry.6	INTEGER	R/O	R/O
ipRouteNextHop	ipRouteEntry.7	IpAddress	R/O	R/O
ipRouteType	ipRouteEntry.8	INTEGER	R/O	R/O
ipRouteProto	ipRouteEntry.9	INTEGER	R/O	Y
ipRouteAge	ipRouteEntry.10	INTEGER	-	N
ipRouteMask	ipRouteEntry.11	IpAddress	R/O	R/O
ipRouteMetric5	ipRouteEntry.12	INTEGER	-	N
ipRouteInfo	ipRouteEntry.13	ObjectID	R/O	Y
ipNetToMediaTable	ip.22	Aggregate	-	-
ipNetToMediaEntry	ipNetToMediaTable.1	Aggregate	-	-
ipNetToMediaIfIndex	ipNetToMediaEntry.1	INTEGER	R/O	R/O
ipNetToMediaPhysAddress	ipNetToMediaEntry.2	OctetString	R/O	R/O
ipNetToMediaNetAddress	ipNetToMediaEntry.3	IpAddress	R/O	R/O
ipNetToMediaType	ipNetToMediaEntry.4	INTEGER	R/O	R/O
ipRoutingDiscards	ip.23	Counter	R/O	Y

20. NETWORK CONTROL

• icmp group

MIB	OID	SYNTAX	ACCESS	SUPPORT
icmpInMsgs	icmp.1	Counter	R/O	Y
icmpInErrors	icmp.2	Counter	R/O	Y
icmpInDestUnreachs	icmp.3	Counter	R/O	Y
icmpInTimeExcds	icmp.4	Counter	R/O	Y
icmpInParmProbs	icmp.5	Counter	R/O	Y
icmpInSrcQuenchs	icmp.6	Counter	R/O	Y
icmpInRedirects	icmp.7	Counter	R/O	Y
icmpInEchos	icmp.8	Counter	R/O	Y
icmpInEchoReps	icmp.9	Counter	R/O	Y
icmpInTimestamps	icmp.10	Counter	R/O	Y
icmpInTimestampReps	icmp.11	Counter	R/O	Y
icmpInAddrMasks	icmp.12	Counter	R/O	Y
icmpInAddrMaskReps	icmp.13	Counter	R/O	Y
icmpOutMsgs	icmp.14	Counter	R/O	Y
icmpOutErrors	icmp.15	Counter	R/O	Y
icmpOutDestUnreachs	icmp.16	Counter	R/O	Y
icmpOutTimeExcds	icmp.17	Counter	R/O	Y
icmpOutParmProbs	icmp.18	Counter	R/O	Y
icmpOutSrcQuenchs	icmp.19	Counter	R/O	Y
icmpOutRedirects	icmp.20	Counter	R/O	Y
icmpOutEchos	icmp.21	Counter	R/O	Y
icmpOutEchoReps	icmp.22	Counter	R/O	Y
icmpOutTimestamps	icmp.23	Counter	R/O	Y
icmpOutTimestampReps	icmp.24	Counter	R/O	Y
icmpOutAddrMasks	icmp.25	Counter	R/O	Y
icmpOutAddrMaskReps	icmp.26	Counter	R/O	Y

• tcp group

MIB	OID	SYNTAX	ACCESS	SUPPORT
tcpRtoAlgorithm	tcp.1	INTEGER	R/O	Y
tcpRtoMin	tcp.2	INTEGER	R/O	Y
tcpRtoMax	tcp.3	INTEGER	R/O	Y
tcpMaxConn	tcp.4	INTEGER	R/O	Y
tcpActiveOpens	tcp.5	Counter	R/O	Y
tcpPassiveOpens	tcp.6	Counter	R/O	Y
tcpAttemptFails	tcp.7	Counter	R/O	Y
tcpEstabResets	tcp.8	Counter	R/O	Y
tcpCurrEstab	tcp.9	Gauge	R/O	Y
tcpInSegs	tcp.10	Counter	R/O	Y
tcpOutSegs	tcp.11	Counter	R/O	Y
tcpRetransSegs	tcp.12	Counter	R/O	Y
tcpConnTable	tcp.13	Aggregate	-	-
tcpConnEntry	tcpConnTable.1	Aggregate	-	-
tcpConnState	tcpConnEntry.1	INTEGER	R/O	R/O
tcpConnLocalAddress	tcpConnEntry.2	IpAddress	R/O	Y
tcpConnLocalPort	tcpConnEntry.3	INTEGER	R/O	Y
tcpConnRemAddress	tcpConnEntry.4	IpAddress	R/O	Y
tcpConnRemPort	tcpConnEntry.5	INTEGER	R/O	Y
tcpInErrs	tcp.14	Counter	R/O	Y
tcpOutRsts	tcp.15	Counter	R/O	Y

20. NETWORK CONTROL

• udp group

MIB	OID	SYNTAX	ACCESS	SUPPORT
udpInDatagrams	udp.1	Counter	R/O	Y
udpNoPorts	udp.2	Counter	R/O	Y
udpInErrors	udp.3	Counter	R/O	Y
udpOutDatagrams	udp.4	Counter	R/O	Y
udpTable	udp.5	Aggregate	-	-
udpEntry	udpTable.1	Aggregate	-	-
udpLocalAddress	udpEntry.1	IpAddress	R/O	Y
udpLocalPort	udpEntry.2	INTEGER	R/O	Y

• snmp group

MIB	OID	SYNTAX	ACCESS	SUPPORT
snmpInPkts	snmp.1	Counter	R/O	Y
snmpOutPkts	snmp.2	Counter	R/O	Y
snmpInBadVersions	snmp.3	Counter	R/O	Y
snmpInBadCommunityNames	snmp.4	Counter	R/O	Y
snmpInBadCommunityUses	snmp.5	Counter	R/O	Y
snmpInASNParseErrs	snmp.6	Counter	R/O	Y
snmpInTooBig	snmp.7	Counter	R/O	Y
snmpInNoSuchNames	snmp.8	Counter	R/O	Y
snmpInBadValues	snmp.9	Counter	R/O	Y
snmpInReadOnly	snmp.10	Counter	R/O	Y
snmpInGenErrs	snmp.11	Counter	R/O	Y
snmpInTotalReqVars	snmp.12	Counter	R/O	Y
snmpInTotalSetVars	snmp.13	Counter	R/O	Y
snmpInGetRequests	snmp.14	Counter	R/O	Y
snmpInGetNexts	snmp.15	Counter	R/O	Y
snmpInSetRequests	snmp.16	Counter	R/O	Y
snmpInGetResponses	snmp.17	Counter	R/O	Y
snmpInTraps	snmp.18	Counter	R/O	Y
snmpOutTooBig	snmp.19	Counter	R/O	Y
snmpOutNoSuchNames	snmp.20	Counter	R/O	Y
snmpOutBadValues	snmp.21	Counter	R/O	Y
snmpOutGenErrs	snmp.22	Counter	R/O	Y
snmpOutGetRequests	snmp.23	Counter	R/O	Y
snmpOutGetNexts	snmp.24	Counter	R/O	Y
snmpOutSetRequests	snmp.25	Counter	R/O	Y
snmpOutGetResponses	snmp.26	Counter	R/O	Y
snmpOutTraps	snmp.27	Counter	R/O	Y
snmpEnableAuthenTraps	snmp.28	IpAddress	R/W	Y

20.5.4 Enterprise MIB

- Enterprise Number

The Enterprise Number of LEADER ELECTRONICS CORP. is 20111.
 iso(1).org(3).dod(6).internet(1).private(4).enterprises(1).leader(20111)

- Enterprise MIB File

Save the file from instrument to a USB memory device or use FTP to obtain it from the instrument.

The file name is "lv5600.my."

[See also] 7.2.9, "Configuring SNMP", 20.3, "FTP"

- Enterprise MIB Structure

The enterprise MIB structure is shown below. On products that do not have units installed, the MIBs for the units cannot be controlled.

```

leader                OBJECT IDENTIFIER ::= { enterprises 20111 }
lv5600                OBJECT IDENTIFIER ::= { leader 40 }
lv5600ST1            OBJECT IDENTIFIER ::= { lv5600 1 }
l40notificationTBL   OBJECT IDENTIFIER ::= { lv5600ST1 0 }
l40basicTBL          OBJECT IDENTIFIER ::= { lv5600ST1 1 }
l40systemTBL         OBJECT IDENTIFIER ::= { lv5600ST1 2 }
l40wfmTBL            OBJECT IDENTIFIER ::= { lv5600ST1 3 }
l40vectorTBL         OBJECT IDENTIFIER ::= { lv5600ST1 4 }
l40pictureTBL        OBJECT IDENTIFIER ::= { lv5600ST1 5 }
l40statusTBL         OBJECT IDENTIFIER ::= { lv5600ST1 6 }
l40eyeTBL            OBJECT IDENTIFIER ::= { lv5600ST1 7 }
l40audioTBL          OBJECT IDENTIFIER ::= { lv5600ST1 8 }
l40trapTBL           OBJECT IDENTIFIER ::= { lv5600ST1 9 }
    
```

- ACCESS

In the tables, "ACCESS" indicates the following:

	Indication	Description
ACCESS	R/O	Information that can be read from the SNMP managers.
	R/W	Information that can be read and written from the SNMP managers
	R/WO	Information that can be read and written from the SNMP managers (However, the retrieved data consists of meaningless fixed values.)

20. NETWORK CONTROL

- I40basicTBL(1) group

MIB	OID	SYNTAX	ACCESS	VALUE/RANGE
I40basInputTBL	I40basicTBL.1	Aggregate	-	-
I40basInputCh	I40basInputTBL.1	INTEGER	R/W	1 = a 2 = b 3 = c 4 = d * Switch between 1:A-Bch and 3:C-Dch when the 4K 3G Dual Link, HD Dual Link, 3G Dual Link, or 4K 2 screen is displayed.
I40basInputSimul	I40basInputTBL.2	INTEGER	R/W	1 = off 2 = on
I40basInputOperate	I40basInputTBL.3	INTEGER	R/W	1 = com 2 = individual
I40basInputExtref	I40basInputTBL.4	INTEGER	R/W	1 = int 2 = ext
I40basDispTBL	I40basicTBL.3	Aggregate	-	-
I40basDispMulti	I40basDispTBL.1	INTEGER	R/WO	1 (fixed)
I40basDispAssignWfm	I40basDispTBL.2	INTEGER	R/WO	1 (fixed)
I40basDispAssignVec	I40basDispTBL.3	INTEGER	R/WO	1 (fixed)
I40basDispAssignPic	I40basDispTBL.4	INTEGER	R/WO	1 (fixed)
I40basDispAssignSts	I40basDispTBL.5	INTEGER	R/WO	1 (fixed)
I40basDispAssignEye	I40basDispTBL.6	INTEGER	R/WO	1 (fixed)
I40basDispAssignAud	I40basDispTBL.7	INTEGER	R/WO	1 (fixed)
I40basPresetTBL	I40basicTBL.4	Aggregate	-	-
I40basPresetStore	I40basPresetTBL.1	INTEGER	R/W	1 to 60
I40basPresetDelete	I40basPresetTBL.2	INTEGER	R/W	1 to 60
I40basPresetCopyUsbInt	I40basPresetTBL.3	INTEGER	R/WO	1 (fixed)
I40basPresetCopyIntUsb	I40basPresetTBL.4	INTEGER	R/WO	1 (fixed)
I40basPresetRecall	I40basPresetTBL.5	INTEGER	R/W	1 to 60
I40basCaptureTBL	I40basicTBL.5	Aggregate	-	-
I40basCaptureMode	I40basCaptureTBL.1	INTEGER	R/W	1 = screen 2 = frame-sdi (Sdi Code Value) 3 = frame-converted (Converted)
I40basCaptureTrigger	I40basCaptureTBL.2	INTEGER	R/W	1 = manual 2 = error
I40basCaptureRefresh	I40basCaptureTBL.3	INTEGER	R/WO	1 (fixed)
I40basCaptureDisplay	I40basCaptureTBL.4	INTEGER	R/W	1 = real 2 = replay (video frame only) 3 = both 4 = hold
I40basCaptureFileBmp	I40basCaptureTBL.5	INTEGER	R/W	1 = off 2 = on
I40basCaptureFileBsg	I40basCaptureTBL.6	INTEGER	R/W	1 = off 2 = on
I40basCaptureFileDpx	I40basCaptureTBL.7	INTEGER	R/W	1 = off 2 = on
I40basCaptureFileTif	I40basCaptureTBL.8	INTEGER	R/W	1 = off 2 = on
I40basCaptureFileFrm	I40basCaptureTBL.9	INTEGER	R/W	1 = off 2 = on

20. NETWORK CONTROL

MIB	OID	SYNTAX	ACCESS	VALUE/RANGE
I40basCaptureFileStore	I40basCaptureTBL.10	INTEGER	R/WO	1 (fixed)
I40basMakeTBL	I40basicTBL.6	Aggregate	-	-
I40basMakeFile	I40basMakeTBL.1	INTEGER	R/WO	1 = cap-bmp 2 = cap-bsg 3 = cap-frm-a (*1) 4 = cap-dpx-a (*1) 5 = cap-tif-a (*1) 6 = cap-frm-b (*1) 7 = cap-dpx b (*1) 8 = cap-tif-b (*1) 9 = cap-frm-c (*1) 10 = cap-dpx-c (*1) 11 = cap-tif-c (*1) 12 = cap-frm-d (*1) 13 = cap-dpx-d (*1) 14 = cap-tif-d (*1) 15 = log (*2) 16 = dump (*2) 17 = loud (*2)

*1 If you want to create a frame capture file (DPX, TIF, FRM), a video signal waveform, vector waveform, or picture must be displayed on the screen.

When multiple frames are selected in frame capture, CAP_DPX*, CAP_TIF*, and CAP_FRM* are not supported.

*2 If you want to create an event log, data dump, or loudness file, the corresponding measurement screen must be displayed on the screen.

• I40systemTBL(2) group

MIB	OID	SYNTAX	ACCESS	VALUE/RANGE
I40sysInputTBL	I40systemTBL.1	Aggregate	-	-
I40sysSdiIn	I40sysInputTBL.1	INTEGER	R/W	1 = sys-4k-3g-qlink 2 = sys-4k-3g-dlink 3 = sys-4k-hd-qlink 4 = sys-single-link 5 = sys-hd-dlink 6 = sys-3g-dlink 7 = sys-3gb-dstream 8 = sys-4k-12g 9 = sys-4k-6g 10 = sys-4k-ip-single 11 = sys-4k-ip-quad
I40sysSdiColorimetry	I40sysInputTBL.2	INTEGER	R/W	1 = pid 2 = bt709 3 = bt2020 4 = dci
I40sysDisplayAssignmentInput A	I40sysInputTBL.3	INTEGER	R/W	1 = SDI1 2 = SDI2 3 = SDI3 4 = SDI4 5 = Stream1 6 = Stream2 7 = Stream3 8 = Stream4
I40sysDisplayAssignmentInput B	I40sysInputTBL.4	INTEGER	R/W	1 = SDI1 2 = SDI2 3 = SDI3 4 = SDI4

20. NETWORK CONTROL

MIB	OID	SYNTAX	ACCESS	VALUE/RANGE
				5 = Stream1 6 = Stream2 7 = Stream3 8 = Stream4
I40sysDisplayAssignmentInputC	I40sysInputTBL.5	INTEGER	R/W	1 = SDI1 2 = SDI2 3 = SDI3 4 = SDI4 5 = Stream1 6 = Stream2 7 = Stream3 8 = Stream4
I40sysDisplayAssignmentInputD	I40sysInputTBL.6	INTEGER	R/W	1 = SDI1 2 = SDI2 3 = SDI3 4 = SDI4 5 = Stream1 6 = Stream2 7 = Stream3 8 = Stream4
I40sysOutTBL	I40systemTBL.2	Aggregate	-	-
I40sysMonitorOutTBL	I40systemTBL.3	Aggregate	-	-
I40sysHdrTBL	I40systemTBL.4	Aggregate	-	-
I40sysHdrInputAMode	I40sysHdrTBL.1	INTEGER	R/W	1 = off 2 = hlg 3 = pq 4 = slog3 5 = c-log 6 = log-c
I40sysHdrInputBMode	I40sysHdrTBL.2	INTEGER	R/W	1 = off 2 = hlg 3 = pq 4 = slog3 5 = c-log 6 = log-c
I40sysHdrInputCMode	I40sysHdrTBL.3	INTEGER	R/W	1 = off 2 = hlg 3 = pq 4 = slog3 5 = c-log 6 = log-c
I40sysHdrInputDMode	I40sysHdrTBL.4	INTEGER	R/W	1 = off 2 = hlg 3 = pq 4 = slog3 5 = c-log 6 = log-c
I40sysHdrInputASysGamma	I40sysHdrTBL.5	INTEGER	R/W	1 = off 2 = on
I40sysHdrInputBSysGamma	I40sysHdrTBL.6	INTEGER	R/W	1 = off 2 = on
I40sysHdrInputCSysGamma	I40sysHdrTBL.7	INTEGER	R/W	1 = off 2 = on
I40sysHdrInputDSysGamma	I40sysHdrTBL.8	INTEGER	R/W	1 = off 2 = on
I40sysHdrInputAHlgScale	I40sysHdrTBL.9	INTEGER	R/W	1 = off 2 = on
I40sysHdrInputBHlgScale	I40sysHdrTBL.10	INTEGER	R/W	1 = off

20. NETWORK CONTROL

MIB	OID	SYNTAX	ACCESS	VALUE/RANGE
				2 = on
I40sysHdrInputCHlgScale	I40sysHdrTBL.11	INTEGER	R/W	1 = off 2 = on
I40sysHdrInputDHlgScale	I40sysHdrTBL.12	INTEGER	R/W	1 = off 2 = on
I40sysHdrInputARange	I40sysHdrTBL.13	INTEGER	R/W	1 = narrow 2 = full
I40sysHdrInputBRange	I40sysHdrTBL.14	INTEGER	R/W	1 = narrow 2 = full
I40sysHdrInputCRange	I40sysHdrTBL.15	INTEGER	R/W	1 = narrow 2 = full
I40sysHdrInputDRange	I40sysHdrTBL.16	INTEGER	R/W	1 = narrow 2 = full
I40sysHdrInputAEi	I40sysHdrTBL.17	INTEGER	R/W	1 = ei-200 2 = ei-400 3 = ei-800 4 = ei-1600
I40sysHdrInputBEi	I40sysHdrTBL.18	INTEGER	R/W	1 = ei-200 2 = ei-400 3 = ei-800 4 = ei-1600
I40sysHdrInputCEi	I40sysHdrTBL.19	INTEGER	R/W	1 = ei-200 2 = ei-400 3 = ei-800 4 = ei-1600
I40sysHdrInputDEi	I40sysHdrTBL.20	INTEGER	R/W	1 = ei-200 2 = ei-400 3 = ei-800 4 = ei-1600
I40sysHdrInputADetectPayload Id	I40sysHdrTBL.21	INTEGER	R/W	1 = off 2 = on
I40sysHdrInputBDetectPayload Id	I40sysHdrTBL.22	INTEGER	R/W	1 = off 2 = on
I40sysHdrInputCDetectPayload Id	I40sysHdrTBL.23	INTEGER	R/W	1 = off 2 = on
I40sysHdrInputDDetectPayload Id	I40sysHdrTBL.24	INTEGER	R/W	1 = off 2 = on
I40sysHdrInputARefLvHlg	I40sysHdrTBL.25	INTEGER	R/W	1 = reflv-50-per 2 = reflv-75-per
I40sysHdrInputBRefLvHlg	I40sysHdrTBL.26	INTEGER	R/W	1 = reflv-50-per 2 = reflv-75-per
I40sysHdrInputCRefLvHlg	I40sysHdrTBL.27	INTEGER	R/W	1 = reflv-50-per 2 = reflv-75-per
I40sysHdrInputDRefLvHlg	I40sysHdrTBL.28	INTEGER	R/W	1 = reflv-50-per 2 = reflv-75-per
I40sysHdrInputARefLvPq	I40sysHdrTBL.29	INTEGER	R/W	1 = reflv-51-per 2 = reflv-58-per
I40sysHdrInputBRefLvPq	I40sysHdrTBL.30	INTEGER	R/W	1 = reflv-51-per 2 = reflv-58-per
I40sysHdrInputCRefLvPq	I40sysHdrTBL.31	INTEGER	R/W	1 = reflv-51-per 2 = reflv-58-per
I40sysHdrInputDRefLvPq	I40sysHdrTBL.32	INTEGER	R/W	1 = reflv-51-per 2 = reflv-58-per
I40sysSetupTBL	I40systemTBL.5	Aggregate	-	-
I40sysDateTime	I40sysSetupTBL.1	DisplayString	R/O	Date and Time
I40sysSerIp1IpAddress	I40sysSetupTBL.2	DisplayString	R/W	IP Address
I40sysSerIp1SubnetMask	I40sysSetupTBL.3	DisplayString	R/W	IP Address

20. NETWORK CONTROL

MIB	OID	SYNTAX	ACCESS	VALUE/RANGE
I40sysSerIp1DefaultGateway	I40sysSetupTBL.4	DisplayString	R/W	IP Address
I40sysSerIp2IpAddress	I40sysSetupTBL.5	DisplayString	R/W	IP Address
I40sysSerIp2SubnetMask	I40sysSetupTBL.6	DisplayString	R/W	IP Address
I40sysSerIp2DefaultGateway	I40sysSetupTBL.7	DisplayString	R/W	IP Address
I40sysInfoTBL	I40systemTBL.6	Aggregate	-	-
I40sysInfoFirmware	I40sysInfoTBL.1	DisplayString	R/O	Firmware Version
I40sysInfoSer01	I40sysInfoTBL.2	INTEGER	R/O	1 = notavailable 2 = available
I40sysInfoSer02	I40sysInfoTBL.3	INTEGER	R/O	1 = notavailable 2 = available
I40sysInfoSer03	I40sysInfoTBL.4	INTEGER	R/O	1 = notavailable 2 = available
I40sysInfoSer05	I40sysInfoTBL.5	INTEGER	R/O	1 = notavailable 2 = available
I40sysIpsetupTBL	I40systemTBL.7	Aggregate	-	-
I40sysIpType	I40sysIpsetupTBL.1	INTEGER	R/W	1 = st2022-6 2 = st2110 3 = st2110-tsg 4 = st2110-jxs
I40sysIpRedundancy	I40sysIpsetupTBL.2	INTEGER	R/W	1 = notavailable 2 = available
I40sysIpVideoTBL	I40sysIpsetupTBL.3	Aggregate	-	-
I40sysIpVideoPort1TBL	I40sysIpVideoTBL.1	Aggregate	-	-
I40sysIpVideoPort1Stream1TBL	I40sysIpVideoPort1TBL.1	Aggregate	-	-
I40sysIpVideoPort1Stream1SrcTBL	I40sysIpVideoPort1Stream1TBL.1	Aggregate	-	-
I40sysIpVideoPort1Stream1SrcMask	I40sysIpVideoPort1Stream1SrcTBL.1	INTEGER	R/W	1 = off 2 = on
I40sysIpVideoPort1Stream1SrcAddr	I40sysIpVideoPort1Stream1SrcTBL.2	DisplayString	R/W	IP Address
I40sysIpVideoPort1Stream1DstTBL	I40sysIpVideoPort1Stream1TBL.2	Aggregate	-	-
I40sysIpVideoPort1Stream1DstMask	I40sysIpVideoPort1Stream1DstTBL.1	INTEGER	R/W	1 = off 2 = on
I40sysIpVideoPort1Stream1DstAddr	I40sysIpVideoPort1Stream1DstTBL.2	DisplayString	R/W	IP Address(IPv4)
I40sysIpVideoPort1Stream1DstcPort	I40sysIpVideoPort1Stream1DstTBL.3	INTEGER	R/W	1 to 65535
I40sysIpVideoPort1Stream1VlanMask	I40sysIpVideoPort1Stream1TBL.3	INTEGER	R/W	1 = off 2 = on
I40sysIpVideoPort1Stream1VlanId	I40sysIpVideoPort1Stream1TBL.4	INTEGER	R/W	1 to 4094
I40sysIpVideoPort1Stream2TBL	I40sysIpVideoPort1TBL.2	Aggregate	-	-
I40sysIpVideoPort1Stream2SrcTBL	I40sysIpVideoPort1Stream2TBL.1	Aggregate	-	-
I40sysIpVideoPort1Stream2SrcMask	I40sysIpVideoPort1Stream2SrcTBL.1	INTEGER	R/W	1 = off 2 = on
I40sysIpVideoPort1Stream2SrcAddr	I40sysIpVideoPort1Stream2SrcTBL.2	DisplayString	R/W	IP Address
I40sysIpVideoPort1Stream2DstTBL	I40sysIpVideoPort1Stream2TBL.2	Aggregate	-	-
I40sysIpVideoPort1Stream2DstMask	I40sysIpVideoPort1Stream2DstTBL.1	INTEGER	R/W	1 = off 2 = on
I40sysIpVideoPort1Stream2DstAddr	I40sysIpVideoPort1Stream2DstTBL.2	DisplayString	R/W	IP Address(IPv4)

20. NETWORK CONTROL

MIB	OID	SYNTAX	ACCESS	VALUE/RANGE
I40sysIpVideoPort1Stream2Dst cPort	I40sysIpVideoPort1Stre am2DstTBL.3	INTEGER	R/W	1 to 65535
I40sysIpVideoPort1Stream2Vla nMask	I40sysIpVideoPort1Stre am2TBL.3	INTEGER	R/W	1 = off 2 = on
I40sysIpVideoPort1Stream2Vla nId	I40sysIpVideoPort1Stre am2TBL.4	INTEGER	R/W	1 to 4094
I40sysIpVideoPort1Stream3TB L	I40sysIpVideoPort1TBL. 3	Aggregate	-	-
I40sysIpVideoPort1Stream3Src TBL	I40sysIpVideoPort1Stre am3TBL.1	Aggregate	-	-
I40sysIpVideoPort1Stream3Src Mask	I40sysIpVideoPort1Stre am3SrcTBL.1	INTEGER	R/W	1 = off 2 = on
I40sysIpVideoPort1Stream3Src Addr	I40sysIpVideoPort1Stre am3SrcTBL.2	DisplayString	R/W	IP Address
I40sysIpVideoPort1Stream3Dst TBL	I40sysIpVideoPort1Stre am3TBL.2	Aggregate	-	-
I40sysIpVideoPort1Stream3Dst Mask	I40sysIpVideoPort1Stre am3DstTBL.1	INTEGER	R/W	1 = off 2 = on
I40sysIpVideoPort1Stream3Dst Addr	I40sysIpVideoPort1Stre am3DstTBL.2	DisplayString	R/W	IP Address(IPv4)
I40sysIpVideoPort1Stream3Dst cPort	I40sysIpVideoPort1Stre am3DstTBL.3	INTEGER	R/W	1 to 65535
I40sysIpVideoPort1Stream3Vla nMask	I40sysIpVideoPort1Stre am3TBL.3	INTEGER	R/W	1 = off 2 = on
I40sysIpVideoPort1Stream3Vla nId	I40sysIpVideoPort1Stre am3TBL.4	INTEGER	R/W	1 to 4094
I40sysIpVideoPort1Stream4TB L	I40sysIpVideoPort1TBL. 4	Aggregate	-	-
I40sysIpVideoPort1Stream4Src TBL	I40sysIpVideoPort1Stre am4TBL.1	Aggregate	-	-
I40sysIpVideoPort1Stream4Src Mask	I40sysIpVideoPort1Stre am4SrcTBL.1	INTEGER	R/W	1 = off 2 = on
I40sysIpVideoPort1Stream4Src Addr	I40sysIpVideoPort1Stre am4SrcTBL.2	DisplayString	R/W	IP Address
I40sysIpVideoPort1Stream4Dst TBL	I40sysIpVideoPort1Stre am4TBL.2	Aggregate	-	-
I40sysIpVideoPort1Stream4Dst Mask	I40sysIpVideoPort1Stre am4DstTBL.1	INTEGER	R/W	1 = off 2 = on
I40sysIpVideoPort1Stream4Dst Addr	I40sysIpVideoPort1Stre am4DstTBL.2	DisplayString	R/W	IP Address(IPv4)
I40sysIpVideoPort1Stream4Dst cPort	I40sysIpVideoPort1Stre am4DstTBL.3	INTEGER	R/W	1 to 65535
I40sysIpVideoPort1Stream4Vla nMask	I40sysIpVideoPort1Stre am4TBL.3	INTEGER	R/W	1 = off 2 = on
I40sysIpVideoPort1Stream4Vla nId	I40sysIpVideoPort1Stre am4TBL.4	INTEGER	R/W	1 to 4094
I40sysIpVideoPort2TBL	I40sysIpVideoTBL.2	Aggregate	-	-
I40sysIpVideoPort2Stream1TB L	I40sysIpVideoPort2TBL. 1	Aggregate	-	-
I40sysIpVideoPort2Stream1Src TBL	I40sysIpVideoPort2Stre am1TBL.1	Aggregate	-	-
I40sysIpVideoPort2Stream1Src Mask	I40sysIpVideoPort2Stre am1SrcTBL.1	INTEGER	R/W	1 = off 2 = on
I40sysIpVideoPort2Stream1Src Addr	I40sysIpVideoPort2Stre am1SrcTBL.2	DisplayString	R/W	IP Address
I40sysIpVideoPort2Stream1Dst TBL	I40sysIpVideoPort2Stre am1TBL.2	Aggregate	-	-

20. NETWORK CONTROL

MIB	OID	SYNTAX	ACCESS	VALUE/RANGE
I40sysIpVideoPort2Stream1DstMask	I40sysIpVideoPort2Stream1DstTBL.1	INTEGER	R/W	1 = off 2 = on
I40sysIpVideoPort2Stream1DstAddr	I40sysIpVideoPort2Stream1DstTBL.2	DisplayString	R/W	IP Address(IPv4)
I40sysIpVideoPort2Stream1DstcPort	I40sysIpVideoPort2Stream1DstTBL.3	INTEGER	R/W	1 to 65535
I40sysIpVideoPort2Stream1VlanMask	I40sysIpVideoPort2Stream1TBL.3	INTEGER	R/W	1 = off 2 = on
I40sysIpVideoPort2Stream1VlanId	I40sysIpVideoPort2Stream1TBL.4	INTEGER	R/W	1 to 4094
I40sysIpVideoPort2Stream2TBL	I40sysIpVideoPort2TBL.2	Aggregate	-	-
I40sysIpVideoPort2Stream2SrcTBL	I40sysIpVideoPort2Stream2TBL.1	Aggregate	-	-
I40sysIpVideoPort2Stream2SrcMask	I40sysIpVideoPort2Stream2SrcTBL.1	INTEGER	R/W	1 = off 2 = on
I40sysIpVideoPort2Stream2SrcAddr	I40sysIpVideoPort2Stream2SrcTBL.2	DisplayString	R/W	IP Address
I40sysIpVideoPort2Stream2DstTBL	I40sysIpVideoPort2Stream2TBL.2	Aggregate	-	-
I40sysIpVideoPort2Stream2DstMask	I40sysIpVideoPort2Stream2DstTBL.1	INTEGER	R/W	1 = off 2 = on
I40sysIpVideoPort2Stream2DstAddr	I40sysIpVideoPort2Stream2DstTBL.2	DisplayString	R/W	IP Address(IPv4)
I40sysIpVideoPort2Stream2DstcPort	I40sysIpVideoPort2Stream2DstTBL.3	INTEGER	R/W	1 to 65535
I40sysIpVideoPort2Stream2VlanMask	I40sysIpVideoPort2Stream2TBL.3	INTEGER	R/W	1 = off 2 = on
I40sysIpVideoPort2Stream2VlanId	I40sysIpVideoPort2Stream2TBL.4	INTEGER	R/W	1 to 4094
I40sysIpVideoPort2Stream3TBL	I40sysIpVideoPort2TBL.3	Aggregate	-	-
I40sysIpVideoPort2Stream3SrcTBL	I40sysIpVideoPort2Stream3TBL.1	Aggregate	-	-
I40sysIpVideoPort2Stream3SrcMask	I40sysIpVideoPort2Stream3SrcTBL.1	INTEGER	R/W	1 = off 2 = on
I40sysIpVideoPort2Stream3SrcAddr	I40sysIpVideoPort2Stream3SrcTBL.2	DisplayString	R/W	IP Address
I40sysIpVideoPort2Stream3DstTBL	I40sysIpVideoPort2Stream3TBL.2	Aggregate	-	-
I40sysIpVideoPort2Stream3DstMask	I40sysIpVideoPort2Stream3DstTBL.1	INTEGER	R/W	1 = off 2 = on
I40sysIpVideoPort2Stream3DstAddr	I40sysIpVideoPort2Stream3DstTBL.2	DisplayString	R/W	IP Address(IPv4)
I40sysIpVideoPort2Stream3DstcPort	I40sysIpVideoPort2Stream3DstTBL.3	INTEGER	R/W	1 to 65535
I40sysIpVideoPort2Stream3VlanMask	I40sysIpVideoPort2Stream3TBL.3	INTEGER	R/W	1 = off 2 = on
I40sysIpVideoPort2Stream3VlanId	I40sysIpVideoPort2Stream3TBL.4	INTEGER	R/W	1 to 4094
I40sysIpVideoPort2Stream4TBL	I40sysIpVideoPort2TBL.4	Aggregate	-	-
I40sysIpVideoPort2Stream4SrcTBL	I40sysIpVideoPort2Stream4TBL.1	Aggregate	-	-
I40sysIpVideoPort2Stream4SrcMask	I40sysIpVideoPort2Stream4SrcTBL.1	INTEGER	R/W	1 = off 2 = on
I40sysIpVideoPort2Stream4SrcAddr	I40sysIpVideoPort2Stream4SrcTBL.1	DisplayString	R/W	IP Address

20. NETWORK CONTROL

MIB	OID	SYNTAX	ACCESS	VALUE/RANGE
Addr	am4SrcTBL.2			
I40sysIpVideoPort2Stream4DstTBL	I40sysIpVideoPort2Stream4TBL.2	Aggregate	-	-
I40sysIpVideoPort2Stream4DstMask	I40sysIpVideoPort2Stream4DstTBL.1	INTEGER	R/W	1 = off 2 = on
I40sysIpVideoPort2Stream4DstAddr	I40sysIpVideoPort2Stream4DstTBL.2	DisplayString	R/W	IP Address(IPv4)
I40sysIpVideoPort2Stream4DstcPort	I40sysIpVideoPort2Stream4DstTBL.3	INTEGER	R/W	1 to 65535
I40sysIpVideoPort2Stream4VlanMask	I40sysIpVideoPort2Stream4TBL.3	INTEGER	R/W	1 = off 2 = on
I40sysIpVideoPort2Stream4VlanId	I40sysIpVideoPort2Stream4TBL.4	INTEGER	R/W	1 to 4094
I40sysIpAudioTBL	I40sysIpsetupTBL.4	Aggregate	-	-
I40sysIpAudioPort1TBL	I40sysIpAudioTBL.1	Aggregate	-	-
I40sysIpAudioPort1Stream1TBL	I40sysIpAudioPort1TBL.1	Aggregate	-	-
I40sysIpAudioPort1Stream1SrcTBL	I40sysIpAudioPort1Stream1TBL.1	Aggregate	-	-
I40sysIpAudioPort1Stream1SrcMask	I40sysIpAudioPort1Stream1SrcTBL.1	INTEGER	R/W	1 = off 2 = on
I40sysIpAudioPort1Stream1SrcAddr	I40sysIpAudioPort1Stream1SrcTBL.2	DisplayString	R/W	IP Address
I40sysIpAudioPort1Stream1DstTBL	I40sysIpAudioPort1Stream1TBL.2	Aggregate	-	-
I40sysIpAudioPort1Stream1DstMask	I40sysIpAudioPort1Stream1DstTBL.1	INTEGER	R/W	1 = off 2 = on
I40sysIpAudioPort1Stream1DstAddr	I40sysIpAudioPort1Stream1DstTBL.2	DisplayString	R/W	IP Address(IPv4)
I40sysIpAudioPort1Stream1DstcPort	I40sysIpAudioPort1Stream1DstTBL.3	INTEGER	R/W	1 to 65535
I40sysIpAudioPort1Stream1VlanMask	I40sysIpAudioPort1Stream1TBL.3	INTEGER	R/W	1 = off 2 = on
I40sysIpAudioPort1Stream1VlanId	I40sysIpAudioPort1Stream1TBL.4	INTEGER	R/W	1 to 4094
I40sysIpAudioPort1Stream2TBL	I40sysIpAudioPort1TBL.2	Aggregate	-	-
I40sysIpAudioPort1Stream2SrcTBL	I40sysIpAudioPort1Stream2TBL.1	Aggregate	-	-
I40sysIpAudioPort1Stream2SrcMask	I40sysIpAudioPort1Stream2SrcTBL.1	INTEGER	R/W	1 = off 2 = on
I40sysIpAudioPort1Stream2SrcAddr	I40sysIpAudioPort1Stream2SrcTBL.2	DisplayString	R/W	IP Address
I40sysIpAudioPort1Stream2DstTBL	I40sysIpAudioPort1Stream2TBL.2	Aggregate	-	-
I40sysIpAudioPort1Stream2DstMask	I40sysIpAudioPort1Stream2DstTBL.1	INTEGER	R/W	1 = off 2 = on
I40sysIpAudioPort1Stream2DstAddr	I40sysIpAudioPort1Stream2DstTBL.2	DisplayString	R/W	IP Address(IPv4)
I40sysIpAudioPort1Stream2DstcPort	I40sysIpAudioPort1Stream2DstTBL.3	INTEGER	R/W	1 to 65535
I40sysIpAudioPort1Stream2VlanMask	I40sysIpAudioPort1Stream2TBL.3	INTEGER	R/W	1 = off 2 = on
I40sysIpAudioPort1Stream2VlanId	I40sysIpAudioPort1Stream2TBL.4	INTEGER	R/W	1 to 4094
I40sysIpAudioPort1Stream3TBL	I40sysIpAudioPort1TBL.3	Aggregate	-	-

20. NETWORK CONTROL

MIB	OID	SYNTAX	ACCESS	VALUE/RANGE
I40sysIpAudioPort1Stream3SrcTBL	I40sysIpAudioPort1Stream3TBL.1	Aggregate	-	-
I40sysIpAudioPort1Stream3SrcMask	I40sysIpAudioPort1Stream3SrcTBL.1	INTEGER	R/W	1 = off 2 = on
I40sysIpAudioPort1Stream3SrcAddr	I40sysIpAudioPort1Stream3SrcTBL.2	DisplayString	R/W	IP Address
I40sysIpAudioPort1Stream3DstTBL	I40sysIpAudioPort1Stream3TBL.2	Aggregate	-	-
I40sysIpAudioPort1Stream3DstMask	I40sysIpAudioPort1Stream3DstTBL.1	INTEGER	R/W	1 = off 2 = on
I40sysIpAudioPort1Stream3DstAddr	I40sysIpAudioPort1Stream3DstTBL.2	DisplayString	R/W	IP Address(IPv4)
I40sysIpAudioPort1Stream3DstcPort	I40sysIpAudioPort1Stream3DstTBL.3	INTEGER	R/W	1 to 65535
I40sysIpAudioPort1Stream3VlanMask	I40sysIpAudioPort1Stream3TBL.3	INTEGER	R/W	1 = off 2 = on
I40sysIpAudioPort1Stream3VlanId	I40sysIpAudioPort1Stream3TBL.4	INTEGER	R/W	1 to 4094
I40sysIpAudioPort1Stream4TBL	I40sysIpAudioPort1TBL.4	Aggregate	-	-
I40sysIpAudioPort1Stream4SrcTBL	I40sysIpAudioPort1Stream4TBL.1	Aggregate	-	-
I40sysIpAudioPort1Stream4SrcMask	I40sysIpAudioPort1Stream4SrcTBL.1	INTEGER	R/W	1 = off 2 = on
I40sysIpAudioPort1Stream4SrcAddr	I40sysIpAudioPort1Stream4SrcTBL.2	DisplayString	R/W	IP Address
I40sysIpAudioPort1Stream4DstTBL	I40sysIpAudioPort1Stream4TBL.2	Aggregate	-	-
I40sysIpAudioPort1Stream4DstMask	I40sysIpAudioPort1Stream4DstTBL.1	INTEGER	R/W	1 = off 2 = on
I40sysIpAudioPort1Stream4DstAddr	I40sysIpAudioPort1Stream4DstTBL.2	DisplayString	R/W	IP Address(IPv4)
I40sysIpAudioPort1Stream4DstcPort	I40sysIpAudioPort1Stream4DstTBL.3	INTEGER	R/W	1 to 65535
I40sysIpAudioPort1Stream4VlanMask	I40sysIpAudioPort1Stream4TBL.3	INTEGER	R/W	1 = off 2 = on
I40sysIpAudioPort1Stream4VlanId	I40sysIpAudioPort1Stream4TBL.4	INTEGER	R/W	1 to 4094
I40sysIpAudioPort2TBL	I40sysIpAudioTBL.2	Aggregate	-	-
I40sysIpAudioPort2Stream1TBL	I40sysIpAudioPort2TBL.1	Aggregate	-	-
I40sysIpAudioPort2Stream1SrcTBL	I40sysIpAudioPort2Stream1TBL.1	Aggregate	-	-
I40sysIpAudioPort2Stream1SrcMask	I40sysIpAudioPort2Stream1SrcTBL.1	INTEGER	R/W	1 = off 2 = on
I40sysIpAudioPort2Stream1SrcAddr	I40sysIpAudioPort2Stream1SrcTBL.2	DisplayString	R/W	IP Address
I40sysIpAudioPort2Stream1DstTBL	I40sysIpAudioPort2Stream1TBL.2	Aggregate	-	-
I40sysIpAudioPort2Stream1DstMask	I40sysIpAudioPort2Stream1DstTBL.1	INTEGER	R/W	1 = off 2 = on
I40sysIpAudioPort2Stream1DstAddr	I40sysIpAudioPort2Stream1DstTBL.2	DisplayString	R/W	IP Address(IPv4)
I40sysIpAudioPort2Stream1DstcPort	I40sysIpAudioPort2Stream1DstTBL.3	INTEGER	R/W	1 to 65535
I40sysIpAudioPort2Stream1VlanMask	I40sysIpAudioPort2Stream1TBL.3	INTEGER	R/W	1 = off 2 = on

20. NETWORK CONTROL

MIB	OID	SYNTAX	ACCESS	VALUE/RANGE
I40sysIpAudioPort2Stream1VlanId	I40sysIpAudioPort2Stream1TBL.4	INTEGER	R/W	1 to 4094
I40sysIpAudioPort2Stream2TBL	I40sysIpAudioPort2TBL.2	Aggregate	-	-
I40sysIpAudioPort2Stream2SrcTBL	I40sysIpAudioPort2Stream2TBL.1	Aggregate	-	-
I40sysIpAudioPort2Stream2SrcMask	I40sysIpAudioPort2Stream2SrcTBL.1	INTEGER	R/W	1 = off 2 = on
I40sysIpAudioPort2Stream2SrcAddr	I40sysIpAudioPort2Stream2SrcTBL.2	DisplayString	R/W	IP Address
I40sysIpAudioPort2Stream2DstTBL	I40sysIpAudioPort2Stream2TBL.2	Aggregate	-	-
I40sysIpAudioPort2Stream2DstMask	I40sysIpAudioPort2Stream2DstTBL.1	INTEGER	R/W	1 = off 2 = on
I40sysIpAudioPort2Stream2DstAddr	I40sysIpAudioPort2Stream2DstTBL.2	DisplayString	R/W	IP Address(IPv4)
I40sysIpAudioPort2Stream2DstcPort	I40sysIpAudioPort2Stream2DstTBL.3	INTEGER	R/W	1 to 65535
I40sysIpAudioPort2Stream2VlanMask	I40sysIpAudioPort2Stream2TBL.3	INTEGER	R/W	1 = off 2 = on
I40sysIpAudioPort2Stream2VlanId	I40sysIpAudioPort2Stream2TBL.4	INTEGER	R/W	1 to 4094
I40sysIpAudioPort2Stream3TBL	I40sysIpAudioPort2TBL.3	Aggregate	-	-
I40sysIpAudioPort2Stream3SrcTBL	I40sysIpAudioPort2Stream3TBL.1	Aggregate	-	-
I40sysIpAudioPort2Stream3SrcMask	I40sysIpAudioPort2Stream3SrcTBL.1	INTEGER	R/W	1 = off 2 = on
I40sysIpAudioPort2Stream3SrcAddr	I40sysIpAudioPort2Stream3SrcTBL.2	DisplayString	R/W	IP Address
I40sysIpAudioPort2Stream3DstTBL	I40sysIpAudioPort2Stream3TBL.2	Aggregate	-	-
I40sysIpAudioPort2Stream3DstMask	I40sysIpAudioPort2Stream3DstTBL.1	INTEGER	R/W	1 = off 2 = on
I40sysIpAudioPort2Stream3DstAddr	I40sysIpAudioPort2Stream3DstTBL.2	DisplayString	R/W	IP Address(IPv4)
I40sysIpAudioPort2Stream3DstcPort	I40sysIpAudioPort2Stream3DstTBL.3	INTEGER	R/W	1 to 65535
I40sysIpAudioPort2Stream3VlanMask	I40sysIpAudioPort2Stream3TBL.3	INTEGER	R/W	1 = off 2 = on
I40sysIpAudioPort2Stream3VlanId	I40sysIpAudioPort2Stream3TBL.4	INTEGER	R/W	1 to 4094
I40sysIpAudioPort2Stream4TBL	I40sysIpAudioPort2TBL.4	Aggregate	-	-
I40sysIpAudioPort2Stream4SrcTBL	I40sysIpAudioPort2Stream4TBL.1	Aggregate	-	-
I40sysIpAudioPort2Stream4SrcMask	I40sysIpAudioPort2Stream4SrcTBL.1	INTEGER	R/W	1 = off 2 = on
I40sysIpAudioPort2Stream4SrcAddr	I40sysIpAudioPort2Stream4SrcTBL.2	DisplayString	R/W	IP Address
I40sysIpAudioPort2Stream4DstTBL	I40sysIpAudioPort2Stream4TBL.2	Aggregate	-	-
I40sysIpAudioPort2Stream4DstMask	I40sysIpAudioPort2Stream4DstTBL.1	INTEGER	R/W	1 = off 2 = on
I40sysIpAudioPort2Stream4DstAddr	I40sysIpAudioPort2Stream4DstTBL.2	DisplayString	R/W	IP Address(IPv4)
I40sysIpAudioPort2Stream4DstcPort	I40sysIpAudioPort2Stream4DstTBL.3	INTEGER	R/W	1 to 65535

20. NETWORK CONTROL

MIB	OID	SYNTAX	ACCESS	VALUE/RANGE
cPort	am4DstTBL.3			
I40sysIpAudioPort2Stream4VlanMask	I40sysIpAudioPort2Stream4TBL.3	INTEGER	R/W	1 = off 2 = on
I40sysIpAudioPort2Stream4VlanId	I40sysIpAudioPort2Stream4TBL.4	INTEGER	R/W	1 to 4094
I40sysIpAncTBL	I40sysIpsetupTBL.5	Aggregate	-	-
I40sysIpAncPort1TBL	I40sysIpAncTBL.1	Aggregate	-	-
I40sysIpAncPort1Stream1TBL	I40sysIpAncPort1TBL.1	Aggregate	-	-
I40sysIpAncPort1Stream1SrcTBL	I40sysIpAncPort1Stream1TBL.1	Aggregate	-	-
I40sysIpAncPort1Stream1SrcMask	I40sysIpAncPort1Stream1SrcTBL.1	INTEGER	R/W	1 = off 2 = on
I40sysIpAncPort1Stream1SrcAddr	I40sysIpAncPort1Stream1SrcTBL.2	DisplayString	R/W	IP Address
I40sysIpAncPort1Stream1DstTBL	I40sysIpAncPort1Stream1TBL.2	Aggregate	-	-
I40sysIpAncPort1Stream1DstMask	I40sysIpAncPort1Stream1DstTBL.1	INTEGER	R/W	1 = off 2 = on
I40sysIpAncPort1Stream1DstAddr	I40sysIpAncPort1Stream1DstTBL.2	DisplayString	R/W	IP Address(IPv4)
I40sysIpAncPort1Stream1DstcPort	I40sysIpAncPort1Stream1DstTBL.3	INTEGER	R/W	1 to 65535
I40sysIpAncPort1Stream1VlanMask	I40sysIpAncPort1Stream1TBL.3	INTEGER	R/W	1 = off 2 = on
I40sysIpAncPort1Stream1VlanId	I40sysIpAncPort1Stream1TBL.4	INTEGER	R/W	1 to 4094
I40sysIpAncPort1Stream2TBL	I40sysIpAncPort1TBL.2	Aggregate	-	-
I40sysIpAncPort1Stream2SrcTBL	I40sysIpAncPort1Stream2TBL.1	Aggregate	-	-
I40sysIpAncPort1Stream2SrcMask	I40sysIpAncPort1Stream2SrcTBL.1	INTEGER	R/W	1 = off 2 = on
I40sysIpAncPort1Stream2SrcAddr	I40sysIpAncPort1Stream2SrcTBL.2	DisplayString	R/W	IP Address
I40sysIpAncPort1Stream2DstTBL	I40sysIpAncPort1Stream2TBL.2	Aggregate	-	-
I40sysIpAncPort1Stream2DstMask	I40sysIpAncPort1Stream2DstTBL.1	INTEGER	R/W	1 = off 2 = on
I40sysIpAncPort1Stream2DstAddr	I40sysIpAncPort1Stream2DstTBL.2	DisplayString	R/W	IP Address(IPv4)
I40sysIpAncPort1Stream2DstcPort	I40sysIpAncPort1Stream2DstTBL.3	INTEGER	R/W	1 to 65535
I40sysIpAncPort1Stream2VlanMask	I40sysIpAncPort1Stream2TBL.3	INTEGER	R/W	1 = off 2 = on
I40sysIpAncPort1Stream2VlanId	I40sysIpAncPort1Stream2TBL.4	INTEGER	R/W	1 to 4094
I40sysIpAncPort1Stream3TBL	I40sysIpAncPort1TBL.3	Aggregate	-	-
I40sysIpAncPort1Stream3SrcTBL	I40sysIpAncPort1Stream3TBL.1	Aggregate	-	-
I40sysIpAncPort1Stream3SrcMask	I40sysIpAncPort1Stream3SrcTBL.1	INTEGER	R/W	1 = off 2 = on
I40sysIpAncPort1Stream3SrcAddr	I40sysIpAncPort1Stream3SrcTBL.2	DisplayString	R/W	IP Address
I40sysIpAncPort1Stream3DstTBL	I40sysIpAncPort1Stream3TBL.2	Aggregate	-	-
I40sysIpAncPort1Stream3DstMask	I40sysIpAncPort1Stream3DstTBL.1	INTEGER	R/W	1 = off 2 = on
I40sysIpAncPort1Stream3DstAddr	I40sysIpAncPort1Stream3DstTBL.2	DisplayString	R/W	IP Address(IPv4)

20. NETWORK CONTROL

MIB	OID	SYNTAX	ACCESS	VALUE/RANGE
ddr	m3DstTBL.2			
I40sysIpAncPort1Stream3DstPort	I40sysIpAncPort1Stream3DstTBL.3	INTEGER	R/W	1 to 65535
I40sysIpAncPort1Stream3VlanMask	I40sysIpAncPort1Stream3TBL.3	INTEGER	R/W	1 = off 2 = on
I40sysIpAncPort1Stream3VlanId	I40sysIpAncPort1Stream3TBL.4	INTEGER	R/W	1 to 4094
I40sysIpAncPort1Stream4TBL	I40sysIpAncPort1TBL.4	Aggregate	-	-
I40sysIpAncPort1Stream4SrcTBL	I40sysIpAncPort1Stream4TBL.1	Aggregate	-	-
I40sysIpAncPort1Stream4SrcMask	I40sysIpAncPort1Stream4SrcTBL.1	INTEGER	R/W	1 = off 2 = on
I40sysIpAncPort1Stream4SrcAddr	I40sysIpAncPort1Stream4SrcTBL.2	DisplayString	R/W	IP Address
I40sysIpAncPort1Stream4DstTBL	I40sysIpAncPort1Stream4TBL.2	Aggregate	-	-
I40sysIpAncPort1Stream4DstMask	I40sysIpAncPort1Stream4DstTBL.1	INTEGER	R/W	1 = off 2 = on
I40sysIpAncPort1Stream4DstAddr	I40sysIpAncPort1Stream4DstTBL.2	DisplayString	R/W	IP Address(IPv4)
I40sysIpAncPort1Stream4DstPort	I40sysIpAncPort1Stream4DstTBL.3	INTEGER	R/W	1 to 65535
I40sysIpAncPort1Stream4VlanMask	I40sysIpAncPort1Stream4TBL.3	INTEGER	R/W	1 = off 2 = on
I40sysIpAncPort1Stream4VlanId	I40sysIpAncPort1Stream4TBL.4	INTEGER	R/W	1 to 4094
I40sysIpAncPort2TBL	I40sysIpAncTBL.2	Aggregate	-	-
I40sysIpAncPort2Stream1TBL	I40sysIpAncPort2TBL.1	Aggregate	-	-
I40sysIpAncPort2Stream1SrcTBL	I40sysIpAncPort2Stream1TBL.1	Aggregate	-	-
I40sysIpAncPort2Stream1SrcMask	I40sysIpAncPort2Stream1SrcTBL.1	INTEGER	R/W	1 = off 2 = on
I40sysIpAncPort2Stream1SrcAddr	I40sysIpAncPort2Stream1SrcTBL.2	DisplayString	R/W	IP Address
I40sysIpAncPort2Stream1DstTBL	I40sysIpAncPort2Stream1TBL.2	Aggregate	-	-
I40sysIpAncPort2Stream1DstMask	I40sysIpAncPort2Stream1DstTBL.1	INTEGER	R/W	1 = off 2 = on
I40sysIpAncPort2Stream1DstAddr	I40sysIpAncPort2Stream1DstTBL.2	DisplayString	R/W	IP Address(IPv4)
I40sysIpAncPort2Stream1DstPort	I40sysIpAncPort2Stream1DstTBL.3	INTEGER	R/W	1 to 65535
I40sysIpAncPort2Stream1VlanMask	I40sysIpAncPort2Stream1TBL.3	INTEGER	R/W	1 = off 2 = on
I40sysIpAncPort2Stream1VlanId	I40sysIpAncPort2Stream1TBL.4	INTEGER	R/W	1 to 4094
I40sysIpAncPort2Stream2TBL	I40sysIpAncPort2TBL.2	Aggregate	-	-
I40sysIpAncPort2Stream2SrcTBL	I40sysIpAncPort2Stream2TBL.1	Aggregate	-	-
I40sysIpAncPort2Stream2SrcMask	I40sysIpAncPort2Stream2SrcTBL.1	INTEGER	R/W	1 = off 2 = on
I40sysIpAncPort2Stream2SrcAddr	I40sysIpAncPort2Stream2SrcTBL.2	DisplayString	R/W	IP Address
I40sysIpAncPort2Stream2DstTBL	I40sysIpAncPort2Stream2TBL.2	Aggregate	-	-
I40sysIpAncPort2Stream2DstMask	I40sysIpAncPort2Stream2DstTBL.1	INTEGER	R/W	1 = off 2 = on

20. NETWORK CONTROL

MIB	OID	SYNTAX	ACCESS	VALUE/RANGE
I40sysIpAncPort2Stream2DstAddr	I40sysIpAncPort2Stream2DstTBL.2	DisplayString	R/W	IP Address(IPv4)
I40sysIpAncPort2Stream2DstcPort	I40sysIpAncPort2Stream2DstTBL.3	INTEGER	R/W	1 to 65535
I40sysIpAncPort2Stream2VlanMask	I40sysIpAncPort2Stream2TBL.3	INTEGER	R/W	1 = off 2 = on
I40sysIpAncPort2Stream2VlanId	I40sysIpAncPort2Stream2TBL.4	INTEGER	R/W	1 to 4094
I40sysIpAncPort2Stream3TBL	I40sysIpAncPort2TBL.3	Aggregate	-	-
I40sysIpAncPort2Stream3SrcTBL	I40sysIpAncPort2Stream3TBL.1	Aggregate	-	-
I40sysIpAncPort2Stream3SrcMask	I40sysIpAncPort2Stream3SrcTBL.1	INTEGER	R/W	1 = off 2 = on
I40sysIpAncPort2Stream3SrcAddr	I40sysIpAncPort2Stream3SrcTBL.2	DisplayString	R/W	IP Address
I40sysIpAncPort2Stream3DstTBL	I40sysIpAncPort2Stream3TBL.2	Aggregate	-	-
I40sysIpAncPort2Stream3DstMask	I40sysIpAncPort2Stream3DstTBL.1	INTEGER	R/W	1 = off 2 = on
I40sysIpAncPort2Stream3DstAddr	I40sysIpAncPort2Stream3DstTBL.2	DisplayString	R/W	IP Address(IPv4)
I40sysIpAncPort2Stream3DstcPort	I40sysIpAncPort2Stream3DstTBL.3	INTEGER	R/W	1 to 65535
I40sysIpAncPort2Stream3VlanMask	I40sysIpAncPort2Stream3TBL.3	INTEGER	R/W	1 = off 2 = on
I40sysIpAncPort2Stream3VlanId	I40sysIpAncPort2Stream3TBL.4	INTEGER	R/W	1 to 4094
I40sysIpAncPort2Stream4TBL	I40sysIpAncPort2TBL.4	Aggregate	-	-
I40sysIpAncPort2Stream4SrcTBL	I40sysIpAncPort2Stream4TBL.1	Aggregate	-	-
I40sysIpAncPort2Stream4SrcMask	I40sysIpAncPort2Stream4SrcTBL.1	INTEGER	R/W	1 = off 2 = on
I40sysIpAncPort2Stream4SrcAddr	I40sysIpAncPort2Stream4SrcTBL.2	DisplayString	R/W	IP Address
I40sysIpAncPort2Stream4DstTBL	I40sysIpAncPort2Stream4TBL.2	Aggregate	-	-
I40sysIpAncPort2Stream4DstMask	I40sysIpAncPort2Stream4DstTBL.1	INTEGER	R/W	1 = off 2 = on
I40sysIpAncPort2Stream4DstAddr	I40sysIpAncPort2Stream4DstTBL.2	DisplayString	R/W	IP Address(IPv4)
I40sysIpAncPort2Stream4DstcPort	I40sysIpAncPort2Stream4DstTBL.3	INTEGER	R/W	1 to 65535
I40sysIpAncPort2Stream4VlanMask	I40sysIpAncPort2Stream4TBL.3	INTEGER	R/W	1 = off 2 = on
I40sysIpAncPort2Stream4VlanId	I40sysIpAncPort2Stream4TBL.4	INTEGER	R/W	1 to 4094
I40sysIpsetupPtpTBL	I40sysIpsetupTBL.6	Aggregate	-	-
I40sysIpsetupPtpDomainPort1	I40sysIpSetupPtpTBL.2	INTEGER	R/W	1 to 127
I40sysIpsetupPtpDomainPort2	I40sysIpSetupPtpTBL.3	INTEGER	R/W	1 to 127
I40sysIpsetupPtpDelayMessageRate	I40sysIpSetupPtpTBL.5	INTEGER	R/W	1 = 128Hz 2 = 64Hz 3 = 32Hz 4 = 16Hz 5 = 8Hz 6 = 4Hz 7 = 2Hz
I40sysIpsetupNmosTBL	I40sysIpsetupTBL.7	Aggregate	-	-

20. NETWORK CONTROL

MIB	OID	SYNTAX	ACCESS	VALUE/RANGE
I40sysIpsetupNmos	I40sysIpSetupNmosTBL.1	INTEGER	R/W	1 = off 2 = on
I40sysIpsetupNmosIs04PortNumber	I40sysIpSetupNmosTBL.3	INTEGER	R/W	0 to 65535
I40sysIpsetupNmosIs04Dnsd	I40sysIpSetupNmosTBL.4	INTEGER	R/W	1 = Multicast 2 = Unicast 3 = Manual
I40sysIpsetupNmosIs04RdsAddress	I40sysIpSetupNmosTBL.5	DisplayString	R/W	IP Address (IPv4)
I40sysIpsetupNmosIs04RdsPortNumber	I40sysIpSetupNmosTBL.6	INTEGER	R/W	0 - 65535
I40sysIpsetupNmosIs04SearchDomain	I40sysIpSetupNmosTBL.7	DisplayString	R/W	Domain Name
I40sysIpsetupNmos2k4kPermission	I40sysIpSetupNmosTBL.8	INTEGER	R/W	1 = deny 2 = allow
I40sysIpsetupNmosIgnoreSource	I40sysIpSetupNmosTBL.9	INTEGER	R/W	1 = off 2 = on
I40sysIpTsgSetupTBL	I40sysIpsetupTBL.8	Aggregate	-	
I40sysIpTsgSetupTestSignal	I40sysIpTsgSetupTBL.1	INTEGER	R/W	1 = off 2 = on
I40sysIpTsgSetupRedundancy	I40sysIpTsgSetupTBL.3	INTEGER	R/W	1 = off 2 = on
I40sysIpTsgSetupVideoTBL	I40sysIpTsgSetupTBL.4	Aggregate	-	
I40sysIpTsgSetupVideoSystem	I40sysIpTsgSetupVideoTBL.1	INTEGER	R/W	1 = 3840x260 2 = 1920x1080 3g-a 3 = 1920x1080 hd 4 = 1280x720
I40sysIpTsgSetupVideoStructure	I40sysIpTsgSetupVideoTBL.2	INTEGER	R/W	1 = YCbCr(422)10bit
I40sysIpTsgSetupVideoRate	I40sysIpTsgSetupVideoTBL.3	INTEGER	R/W	1 = rate-60p 2 = rate-5994p 3 = rate-50p 5 = rate-30p 6 = rate-2997p 7 = rate-25p 9 = rate-24p 10 = rate-2398p 11 = rate-60i 12 = rate-5994i 13 = rate-50i
I40sysIpTsgSetupVideoPattern	I40sysIpTsgSetupVideoTBL.4	INTEGER	R/W	1 = color bar 100% 2 = color bar 75% 3 = multi color bar 100% 4 = multi color bar 75% 5 = multi color bar (+I) 6 = lip sync
I40sysIpTsgSetupVideoScroll	I40sysIpTsgSetupVideoTBL.5	INTEGER	R/W	1 = off 2 = right 3 = left 4 = up 5 = down 6 = right & up 7 = right & down 8 = left & up 9 = left & down

20. NETWORK CONTROL

MIB	OID	SYNTAX	ACCESS	VALUE/RANGE
I40sysIpTsgSetupVideoMovingBox	I40sysIpTsgSetupVideoTBL.6	INTEGER	R/W	1 = off 2 = white 3 = yellow 4 = cyan 5 = green 6 = blue 7 = red 8 = magenta 9 = black
I40sysIpTsgSetupVideoCharGenTBL	I40sysIpTsgSetupVideoTBL.7	Aggregate	-	-
I40sysIpTsgSetupVideoCharGen	I40sysIpTsgSetupVideoCharGenTBL.1	INTEGER	R/W	1 = off 2 = on
I40sysIpTsgSetupVideoCharGenCharacter	I40sysIpTsgSetupVideoCharGenTBL.2	DisplayString	R/W	Character
I40sysIpTsgSetupVideoCharGenPosSample	I40sysIpTsgSetupVideoCharGenTBL.3	INTEGER	R/W	0 - 3858
I40sysIpTsgSetupVideoCharGenPosLine	I40sysIpTsgSetupVideoCharGenTBL.4	INTEGER	R/W	0 - 2158
I40sysIpTsgSetupVideoCharGenMag	I40sysIpTsgSetupVideoCharGenTBL.5	INTEGER	R/W	1 - 4
I40sysIpTsgSetupVideoCharGenColor	I40sysIpTsgSetupVideoCharGenTBL.6	INTEGER	R/W	1 = white 2 = yellow 3 = cyan 4 = green 5 = magenda 6 = red 7 = blue 8 = black
I40sysIpTsgSetupVideoCharGenEdge	I40sysIpTsgSetupVideoCharGenTBL.7	INTEGER	R/W	1 = off 2 = on
I40sysIpTsgSetupVideoCharGenEdgeColor	I40sysIpTsgSetupVideoCharGenTBL.8	INTEGER	R/W	1 = white 2 = yellow 3 = cyan 4 = green 5 = magenda 6 = red 7 = blue 8 = black
I40sysIpTsgSetupVideoCharGenBg	I40sysIpTsgSetupVideoCharGenTBL.9	INTEGER	R/W	1 = off 2 = on
I40sysIpTsgSetupVideoCharGenBgTrans	I40sysIpTsgSetupVideoCharGenTBL.10	INTEGER	R/W	1 = 100% 2 = 75% 3 = 50% 4 = 25% 5 = 0%
I40sysIpTsgSetupVideoCharGenBlink	I40sysIpTsgSetupVideoCharGenTBL.11	INTEGER	R/W	1 = off 2 = on
I40sysIpTsgSetupVideoCharGenBlinkSpeed	I40sysIpTsgSetupVideoCharGenTBL.12	INTEGER	R/W	1 - 8
I40sysIpTsgSetupVideoBitPerPixel	I40sysIpTsgSetupVideoTBL.8	DisplayString	R/W	0.5 to 10.0
I40sysIpTsgSetupAudioTBL	I40sysIpTsgSetupTBL.5	Aggregate	-	
I40sysIpTsgSetupAncTBL	I40sysIpTsgSetupTBL.6	Aggregate	-	
I40sysIpTsgSetupRtpTBL	I40sysIpTsgSetupTBL.7	Aggregate	-	
I40sysIpTsgSetupRtpPayloadTypeVideo	I40sysIpTsgSetupRtpTBL.1	INTEGER	R/W	96 to 127

20. NETWORK CONTROL

MIB	OID	SYNTAX	ACCESS	VALUE/RANGE
I40sysIpTsgSetupRtpPayloadTypeAudio	I40sysIpTsgSetupRtpTBL.2	INTEGER	R/W	96 to 127
I40sysIpTsgSetupRtpPayloadTypeAnc	I40sysIpTsgSetupRtpTBL.3	INTEGER	R/W	96 to 127
I40sysIpTsgSetupRtpVlanTagVideo	I40sysIpTsgSetupRtpTBL.4	INTEGER	R/W	1 to 4094
I40sysIpTsgSetupRtpVlanTagAudio	I40sysIpTsgSetupRtpTBL.5	INTEGER	R/W	1 to 4094
I40sysIpTsgSetupRtpVlanTagAnc	I40sysIpTsgSetupRtpTBL.6	INTEGER	R/W	1 to 4094
I40sysIpTsgSetupRtpDscpTagVideo	I40sysIpTsgSetupRtpTBL.7	INTEGER	R/W	0 to 63
I40sysIpTsgSetupRtpDscpTagAudio	I40sysIpTsgSetupRtpTBL.8	INTEGER	R/W	0 to 63
I40sysIpTsgSetupRtpDscpTagAnc	I40sysIpTsgSetupRtpTBL.9	INTEGER	R/W	0 to 63
I40sysIpTsgSetupRtpPayloadTypeJpegXs	I40sysIpTsgSetupRtpTBL.10	INTEGER	R/W	96 to 127
I40sysIpTsgVideoTBL	I40sysIpTsgSetupTBL.8	Aggregate	-	
I40sysIpTsgVideoPort1TBL	I40sysIpTsgVideoTBL.1	Aggregate	-	
I40sysIpTsgVideoPort1Stream1TBL	I40sysIpTsgVideoPort1TBL.1	Aggregate	-	
I40sysIpTsgVideoPort1Stream1DstTBL	I40sysIpTsgVideoPort1Stream1TBL.2	Aggregate	-	
I40sysIpTsgVideoPort1Stream1DstMask	I40sysIpTsgVideoPort1Stream1DstTBL.1	INTEGER	R/W	1 = off 2 = on
I40sysIpTsgVideoPort1Stream1DstAddr	I40sysIpTsgVideoPort1Stream1DstTBL.2	DisplayString	R/W	IP Address(IPv4)
I40sysIpTsgVideoPort1Stream1DstcPort	I40sysIpTsgVideoPort1Stream1DstTBL.3	INTEGER	R/W	1 to 65535
I40sysIpTsgVideoPort2TBL	I40sysIpTsgVideoTBL.2	Aggregate	-	
I40sysIpTsgVideoPort2Stream1TBL	I40sysIpTsgVideoPort2TBL.1	Aggregate	-	
I40sysIpTsgVideoPort2Stream1DstTBL	I40sysIpTsgVideoPort2Stream1TBL.2	Aggregate	-	
I40sysIpTsgVideoPort2Stream1DstMask	I40sysIpTsgVideoPort2Stream1DstTBL.1	INTEGER	R/W	1 = off 2 = on
I40sysIpTsgVideoPort2Stream1DstAddr	I40sysIpTsgVideoPort2Stream1DstTBL.2	DisplayString	R/W	IP Address(IPv4)
I40sysIpTsgVideoPort2Stream1DstcPort	I40sysIpTsgVideoPort2Stream1DstTBL.3	INTEGER	R/W	1 to 65535
I40sysIpTsgAudioTBL	I40sysIpTsgSetupTBL.9	Aggregate	-	
I40sysIpTsgAudioPort1TBL	I40sysIpTsgAudioTBL.1	Aggregate	-	
I40sysIpTsgAudioPort1Stream1TBL	I40sysIpTsgAudioPort1TBL.1	Aggregate	-	
I40sysIpTsgAudioPort1Stream1DstTBL	I40sysIpTsgAudioPort1Stream1TBL.2	Aggregate	-	
I40sysIpTsgAudioPort1Stream1DstMask	I40sysIpTsgAudioPort1Stream1DstTBL.1	INTEGER	R/W	1 = off 2 = on
I40sysIpTsgAudioPort1Stream1DstAddr	I40sysIpTsgAudioPort1Stream1DstTBL.2	DisplayString	R/W	IP Address(IPv4)
I40sysIpTsgAudioPort1Stream1DstcPort	I40sysIpTsgAudioPort1Stream1DstTBL.3	INTEGER	R/W	1 to 65535
I40sysIpTsgAudioPort2TBL	I40sysIpTsgAudioTBL.2	Aggregate	-	
I40sysIpTsgAudioPort2Stream1TBL	I40sysIpTsgAudioPort2TBL.1	Aggregate	-	
I40sysIpTsgAudioPort2Stream1	I40sysIpTsgAudioPort2	Aggregate	-	

20. NETWORK CONTROL

MIB	OID	SYNTAX	ACCESS	VALUE/RANGE
DstTBL	Stream1TBL.2			
I40sysIpTsgAudioPort2Stream1DstMask	I40sysIpTsgAudioPort2Stream1DstTBL.1	INTEGER	R/W	1 = off 2 = on
I40sysIpTsgAudioPort2Stream1DstAddr	I40sysIpTsgAudioPort2Stream1DstTBL.2	DisplayString	R/W	IP Address(IPv4)
I40sysIpTsgAudioPort2Stream1DstcPort	I40sysIpTsgAudioPort2Stream1DstTBL.3	INTEGER	R/W	1 to 65535
I40sysIpTsgAncTBL	I40sysIpTsgSetupTBL.10	Aggregate	-	
I40sysIpTsgAncPort1TBL	I40sysIpTsgAncTBL.1	Aggregate	-	
I40sysIpTsgAncPort1Stream1TBL	I40sysIpTsgAncPort1TBL.1	Aggregate	-	
I40sysIpTsgAncPort1Stream1DstTBL	I40sysIpTsgAncPort1Stream1TBL.2	Aggregate	-	
I40sysIpTsgAncPort1Stream1DstMask	I40sysIpTsgAncPort1Stream1DstTBL.1	INTEGER	R/W	1 = off 2 = on
I40sysIpTsgAncPort1Stream1DstAddr	I40sysIpTsgAncPort1Stream1DstTBL.2	DisplayString	R/W	IP Address(IPv4)
I40sysIpTsgAncPort1Stream1DstcPort	I40sysIpTsgAncPort1Stream1DstTBL.3	INTEGER	R/W	1 to 65535
I40sysIpTsgAncPort2TBL	I40sysIpTsgAncTBL.2	Aggregate	-	
I40sysIpTsgAncPort2Stream1TBL	I40sysIpTsgAncPort2TBL.1	Aggregate	-	
I40sysIpTsgAncPort2Stream1DstTBL	I40sysIpTsgAncPort2Stream1TBL.2	Aggregate	-	
I40sysIpTsgAncPort2Stream1DstMask	I40sysIpTsgAncPort2Stream1DstTBL.1	INTEGER	R/W	1 = off 2 = on
I40sysIpTsgAncPort2Stream1DstAddr	I40sysIpTsgAncPort2Stream1DstTBL.2	DisplayString	R/W	IP Address(IPv4)
I40sysIpTsgAncPort2Stream1DstcPort	I40sysIpTsgAncPort2Stream1DstTBL.3	INTEGER	R/W	1 to 65535
I40sysIpSdiOutPidInsert	I40sysIpsetupTBL.9	INTEGER	R/W	1 = st2110-40 2 = NMOS(SDP) 3 = Manual
I40sysIpAudioChMapTBL	I40sysIpsetupTBL.10	Aggregate	-	
I40sysIpAudioChMapGroupNumber	I40sysIpAudioChMapTBL.1	INTEGER	R/W	1 = 1 2 = 2 4 = 4
I40sysIpAudioChMapMappingTBL	I40sysIpAudioChMapTBL.2	Aggregate	-	
I40sysIpAudioChMapMappingStream1	I40sysIpAudioChMapMappingTBL.1	INTEGER	R/W	1 = off 2 = on
I40sysIpAudioChMapMappingStream2	I40sysIpAudioChMapMappingTBL.2	INTEGER	R/W	1 = off 2 = on
I40sysIpAudioChMapMappingStream3	I40sysIpAudioChMapMappingTBL.3	INTEGER	R/W	1 = off 2 = on
I40sysIpAudioChMapMappingStream4	I40sysIpAudioChMapMappingTBL.4	INTEGER	R/W	1 = off 2 = on
I40sysIpAudioChMapNumTBL	I40sysIpAudioChMapTBL.3	Aggregate	-	
I40sysIpAudioChMapNumStream1TBL	I40sysIpAudioChMapNumTBL.1	Aggregate	-	
I40sysIpAudioChMapNumStream1G1	I40sysIpAudioChMapNumStream1TBL.1	INTEGER	R/W	0 - 16
I40sysIpAudioChMapNumStream1G2	I40sysIpAudioChMapNumStream1TBL.2	INTEGER	R/W	0 - 16
I40sysIpAudioChMapNumStream1G3	I40sysIpAudioChMapNumStream1TBL.3	INTEGER	R/W	0 - 16

20. NETWORK CONTROL

MIB	OID	SYNTAX	ACCESS	VALUE/RANGE
m1G3	mStream1TBL.3			
I40sysIpAudioChMapNumStream1G4	I40sysIpAudioChMapNumStream1TBL.4	INTEGER	R/W	0 - 16
I40sysIpAudioChMapNumStream2TBL	I40sysIpAudioChMapNumTBL.2	Aggregate	-	
I40sysIpAudioChMapNumStream2G1	I40sysIpAudioChMapNumStream2TBL.1	INTEGER	R/W	0 - 16
I40sysIpAudioChMapNumStream2G2	I40sysIpAudioChMapNumStream2TBL.2	INTEGER	R/W	0 - 16
I40sysIpAudioChMapNumStream2G3	I40sysIpAudioChMapNumStream2TBL.3	INTEGER	R/W	0 - 16
I40sysIpAudioChMapNumStream2G4	I40sysIpAudioChMapNumStream2TBL.4	INTEGER	R/W	0 - 16
I40sysIpAudioChMapNumStream3TBL	I40sysIpAudioChMapNumTBL.3	Aggregate	-	
I40sysIpAudioChMapNumStream3G1	I40sysIpAudioChMapNumStream3TBL.1	INTEGER	R/W	0 - 16
I40sysIpAudioChMapNumStream3G2	I40sysIpAudioChMapNumStream3TBL.2	INTEGER	R/W	0 - 16
I40sysIpAudioChMapNumStream3G3	I40sysIpAudioChMapNumStream3TBL.3	INTEGER	R/W	0 - 16
I40sysIpAudioChMapNumStream3G4	I40sysIpAudioChMapNumStream3TBL.4	INTEGER	R/W	0 - 16
I40sysIpAudioChMapNumStream4TBL	I40sysIpAudioChMapNumTBL.4	Aggregate	-	
I40sysIpAudioChMapNumStream4G1	I40sysIpAudioChMapNumStream4TBL.1	INTEGER	R/W	0 - 16
I40sysIpAudioChMapNumStream4G2	I40sysIpAudioChMapNumStream4TBL.2	INTEGER	R/W	0 - 16
I40sysIpAudioChMapNumStream4G3	I40sysIpAudioChMapNumStream4TBL.3	INTEGER	R/W	0 - 16
I40sysIpAudioChMapNumStream4G4	I40sysIpAudioChMapNumStream4TBL.4	INTEGER	R/W	0 - 16

- I40wfmTBL(3) group

MIB	OID	SYNTAX	ACCESS	VALUE/RANGE
I40wfmIntenConfigTBL	I40wfmTBL.1	Aggregate	-	-
I40wfmModeTBL	I40wfmIntenConfigTBL.1	Aggregate	-	-
I40wfmModeMode	I40wfmModeTBL.1	INTEGER	R/W	1 = parade 2 = overlay
I40wfmModeCh1Y	I40wfmModeTBL.2	INTEGER	R/W	1 = off 2 = on
I40wfmModeCh2Cb	I40wfmModeTBL.3	INTEGER	R/W	1 = off 2 = on
I40wfmModeCh3Cr	I40wfmModeTBL.4	INTEGER	R/W	1 = off 2 = on
I40wfmModeCh1G	I40wfmModeTBL.5	INTEGER	R/W	1 = off 2 = on
I40wfmModeCh2B	I40wfmModeTBL.6	INTEGER	R/W	1 = off 2 = on
I40wfmModeCh3R	I40wfmModeTBL.7	INTEGER	R/W	1 = off 2 = on
I40wfmModeCh1R	I40wfmModeTBL.8	INTEGER	R/W	1 = off 2 = on
I40wfmModeCh2G	I40wfmModeTBL.9	INTEGER	R/W	1 = off 2 = on

20. NETWORK CONTROL

MIB	OID	SYNTAX	ACCESS	VALUE/RANGE
I40wfmModeCh3B	I40wfmModeTBL.10	INTEGER	R/W	1 = off 2 = on
I40wfmMode3gbds	I40wfmModeTBL.11	INTEGER	R/W	1 = stream1 2 = stream2 3 = mix 4 = align
I40wfmModeYParade	I40wfmModeTBL.12	INTEGER	R/W	1 = off 2 = on
I40wfmModeCh1X	I40wfmModeTBL.13	INTEGER	R/W	1 = off 2 = on
I40wfmModeCh2Y	I40wfmModeTBL.14	INTEGER	R/W	1 = off 2 = on
I40wfmModeCh3Z	I40wfmModeTBL.15	INTEGER	R/W	1 = off 2 = on
I40wfmIntenTBL	I40wfmIntenConfigTBL.2	Aggregate	-	-
I40wfmInten	I40wfmIntenTBL.1	INTEGER	R/W	-128 to 127
I40wfmColor	I40wfmIntenTBL.2	INTEGER	R/W	1 = white 2 = yellow 3 = cyan 4 = green 5 = magenta 6 = red 7 = blue 8 = multi
I40wfmColorS1	I40wfmIntenTBL.3	INTEGER	R/W	1 = white 2 = yellow 3 = cyan 4 = green 5 = magenta 6 = red 7 = blue 8 = multi
I40wfmColorS2	I40wfmIntenTBL.4	INTEGER	R/W	1 = white 2 = yellow 3 = cyan 4 = green 5 = magenta 6 = red 7 = blue 8 = multi
I40wfmScaleTBL	I40wfmIntenConfigTBL.3	Aggregate	-	-
I40wfmScaleInten	I40wfmScaleTBL.1	INTEGER	R/W	-8 to 7
I40wfmScaleColor	I40wfmScaleTBL.2	INTEGER	R/W	1 = white 2 = yellow 3 = cyan 4 = green 5 = magenta 6 = red 7 = blue
I40wfmScaleUnit	I40wfmScaleTBL.3	INTEGER	R/W	1 = unit-hdv-sdp 2 = unit-hdv-sdv 3 = unit-hdp-sdp 4 = unit-cv-dec 5 = unit-cv-hex
I40wfmScaleUnitNtsc	I40wfmScaleTBL.4	INTEGER	R/W	3 = unit-hdp-sdp
I40wfmScaleUnitPal	I40wfmScaleTBL.5	INTEGER	R/W	2 = unit-hdv-sdv
I40wfmScaleUnitFullRange	I40wfmScaleTBL.6	INTEGER	R/W	3 = unit-hdp-sdp

20. NETWORK CONTROL

MIB	OID	SYNTAX	ACCESS	VALUE/RANGE
				4 = unit-cv-dec 5 = unit-cv-hex
I40wfmScale75perCol	I40wfmScaleTBL.7	INTEGER	R/W	1 = off 2 = on
I40wfmScaleDisplay	I40wfmScaleTBL.8	INTEGER	R/W	1 = off 2 = on (*1) 3 = main (SER23) (*2) 4 = hdr (SER23) (*2) 5 = both (SER23) (*2) *1 HDR OFF *2 HDR ON
I40wfmGainTBL	I40wfmTBL.2	Aggregate	-	-
I40wfmGainVar	I40wfmGainTBL.1	INTEGER	R/W	1 = cal 2 = variable
I40wfmGainMag	I40wfmGainTBL.2	INTEGER	R/W	1 = x1 2 = x5 3 = x10
I40wfmGainValue	I40wfmGainTBL.3	DisplayString	R/W	0.2 to 2.000
I40wfmGainFilter	I40wfmGainTBL.4	INTEGER	R/W	1 = lowpass 2 = flat
I40wfmGainFilterCmp	I40wfmGainTBL.5	INTEGER	R/W	2 = flat 3 = lum 4 = flatlum 5 = lumchroma
I40wfmGainScaleJump	I40wfmGainTBL.6	INTEGER	R/W	1 = pos-0 2 = pos-10 3 = pos-20 4 = pos-30 5 = pos-40 6 = pos-50 7 = pos-60 8 = pos-70 9 = pos-80 10 = pos-90 11 = pos-100 12 = cursor
I40wfmSweepTBL	I40wfmTBL.3	Aggregate	-	-
I40wfmSweep	I40wfmSweepTBL.1	INTEGER	R/W	1 = h 2 = v
I40wfmSweepMagH	I40wfmSweepTBL.2	INTEGER	R/W	1 = x1 2 = x10 3 = x20 4 = blank 5 = active
I40wfmSweepMagV	I40wfmSweepTBL.3	INTEGER	R/W	1 = x1 2 = x20 3 = x40
I40wfmSweepH	I40wfmSweepTBL.4	INTEGER	R/W	1 = sweep-1h 2 = sweep-2h
I40wfmSweepV	I40wfmSweepTBL.5	INTEGER	R/W	1 = sweep-1v 2 = sweep-2v
I40wfmSweepField	I40wfmSweepTBL.6	INTEGER	R/W	1 = field1 2 = field2
I40wfmBlanking	I40wfmSweepTBL.7	INTEGER	R/W	1 = remove 2 = v 3 = h

20. NETWORK CONTROL

MIB	OID	SYNTAX	ACCESS	VALUE/RANGE
				4 = all
I40wfmBlankingCmp	I40wfmSweepTBL.8	INTEGER	R/W	1 = remove 2 = v
I40wfmMatrixTBL	I40wfmTBL.4	Aggregate	-	-
I40wfmMatrix	I40wfmMatrixTBL.1	INTEGER	R/W	1 = ycbr 2 = gbr 3 = rgb 4 = composite
I40wfmMatrixRgb	I40wfmMatrixTBL.2	INTEGER	R/W	2 = gbr 3 = rgb 4 = composite
I40wfmMatrixYgbr	I40wfmMatrixTBL.3	INTEGER	R/W	1 = off 2 = on
I40wfmMatrixYrgb	I40wfmMatrixTBL.4	INTEGER	R/W	1 = off 2 = on
I40wfmCmpFormat	I40wfmMatrixTBL.5	INTEGER	R/W	1 = auto 2 = ntsc 3 = pal
I40wfmCmpSetup	I40wfmMatrixTBL.6	INTEGER	R/W	1 = setup-0p 2 = setup-75p
I40wfmMatrixXyz	I40wfmMatrixTBL.7	INTEGER	R/W	2 = gbr 3 = rgb 4 = composite 5 = xyz
I40wfmMatrixTBL	I40wfmTBL.4	Aggregate	-	-
I40wfmCursorMode	I40wfmCursorTBL.1	INTEGER	R/W	1 = off 2 = single 3 = both
I40wfmCursorSel	I40wfmCursorTBL.2	INTEGER	R/W	1 = xf 2 = y
I40wfmCursorUnitX	I40wfmCursorTBL.3	INTEGER	R/W	1 = sec 2 = hz
I40wfmCursorUnitY	I40wfmCursorTBL.4	INTEGER	R/W	1 = mv 2 = per 3 = r-per 4 = dec 5 = hex 6 = hdr
I40wfmCursorUnitYCmp	I40wfmCursorTBL.5	INTEGER	R/W	1 = mv 2 = per 3 = r-per
I40wfmCursorRefset	I40wfmCursorTBL.6	INTEGER	R/W	1 (fixed)
I40wfmCursorRefX	I40wfmCursorTBL.7	INTEGER	R/W	0 to 927
I40wfmCursorDeltaX	I40wfmCursorTBL.8	INTEGER	R/W	0 to 927
I40wfmCursorTrackX	I40wfmCursorTBL.9	INTEGER	R/W	-927 to 927
I40wfmCursorRefY	I40wfmCursorTBL.10	INTEGER	R/W	-5000 to 15000
I40wfmCursorDeltaY	I40wfmCursorTBL.11	INTEGER	R/W	-5000 to 15000
I40wfmCursorTrackY	I40wfmCursorTBL.12	INTEGER	R/W	-15000 to 15000
I40wfmLineselTBL	I40wfmTBL.6	Aggregate	-	-
I40wfmLinesel	I40wfmLineselTBL.1	INTEGER	R/W	1 = off 2 = on 3 = cinelite
I40wfmLineselNo	I40wfmLineselTBL.2	INTEGER	R/W	0 to 32767
I40wfmLineselField	I40wfmLineselTBL.3	INTEGER	R/W	1 = frame 2 = field1 3 = field2
I40wfmExtSyncTBL	I40wfmTBL.7	Aggregate	-	-

20. NETWORK CONTROL

MIB	OID	SYNTAX	ACCESS	VALUE/RANGE
I40wfmExtSyncMode	I40wfmExtSyncTBL.1	INTEGER	R/W	1 = off 2 = on
I40wfmExtSyncInten	I40wfmExtSyncTBL.2	INTEGER	R/W	-128 to 127
I40wfmExtSyncColor	I40wfmExtSyncTBL.3	INTEGER	R/W	1 = white 2 = yellow 3 = cyan 4 = green 5 = magenta 6 = red 7 = blue

• I40vectorTBL(4) group

MIB	OID	SYNTAX	ACCESS	VALUE/RANGE
I40vectorIntenConfigTBL	I40vectorTBL.1	Aggregate	-	-
I40vectorDispMode	I40vectorIntenConfigTBL .1	INTEGER	R/W	1 = vector 2 = fivebar 3 = histogram 4 = cie-diagram
I40vectorInten	I40vectorIntenConfigTBL .2	INTEGER	R/W	-128 to 127
I40vectorColor	I40vectorIntenConfigTBL .3	INTEGER	R/W	1 = white 2 = yellow 3 = cyan 4 = green 5 = magenta 6 = red 7 = blue
I40vectorColorS1	I40vectorIntenConfigTBL .4	INTEGER	R/W	1 = white 2 = yellow 3 = cyan 4 = green 5 = magenta 6 = red 7 = blue
I40vectorColorS2	I40vectorIntenConfigTBL .5	INTEGER	R/W	1 = white 2 = yellow 3 = cyan 4 = green 5 = magenta 6 = red 7 = blue
I40vectorDisp3gbds	I40vectorIntenConfigTBL .6	INTEGER	R/W	1 = stream1 2 = stream2 3 = mix 4 = align
I40vectorVectorMode	I40vectorIntenConfigTBL .7	INTEGER	R/W	1 = vector 2 = rgb-vector 3 = ycbcr-vector
I40vectorDispVecTBL	I40vectorTBL.2	Aggregate	-	-
I40vectorDispVecScaleTBL	I40vectorDispVecTBL.1	Aggregate	-	-
I40vectorDispVecScaleInten	I40vectorDispVecScaleTB L.1	INTEGER	R/W	-8 to 7
I40vectorDispVecScaleColor	I40vectorDispVecScaleTB L.2	INTEGER	R/W	1 = white 2 = yellow 3 = cyan 4 = green

20. NETWORK CONTROL

MIB	OID	SYNTAX	ACCESS	VALUE/RANGE
				5 = magenta 6 = red 7 = blue
I40vectorDispVecScaleIq	I40vectorDispVecScaleTBL.3	INTEGER	R/W	1 = off 2 = on
I40vectorDispVecVectorScale	I40vectorDispVecScaleTBL.4	INTEGER	R/W	1 = auto 2 = bt601 3 = bt709 4 = dci 5 = bt2020
I40vectorDispRGBVecAdjustTarget	I40vectorDispVecScaleTBL.5	INTEGER	R/W	1 = gb 2 = gr
I40vectorDispRGBVecAdjustPosH	I40vectorDispVecScaleTBL.6	INTEGER	R/W	-500 to 500
I40vectorDispRGBVecAdjustPosV	I40vectorDispVecScaleTBL.7	INTEGER	R/W	-500 to 500
I40vectorDispYCbCrVecTimingMarker	I40vectorDispVecScaleTBL.8	INTEGER	R/W	1 = auto 2 = hd 3 = sd
I40vectorDispYCbCrVecVectorScale	I40vectorDispVecScaleTBL.9	INTEGER	R/W	1 = auto 2 = bt601 3 = bt709 4 = dci 5 = bt2020
I40vectorDispVecVariableScale	I40vectorDispVecScaleTBL.10	INTEGER	R/W	1 = off 2 = on
I40vectorDispVecGainTBL	I40vectorDispVecTBL.2	Aggregate	-	-
I40vectorDispVecGainVar	I40vectorDispVecGainTBL.1	INTEGER	R/W	1 = cal 2 = variable
I40vectorDispVecGainMag	I40vectorDispVecGainTBL.2	INTEGER	R/W	1 = x1 2 = x5 3 = iq
I40vectorDispVecGainValue	I40vectorDispVecGainTBL.3	DisplayString	R/W	0.2 to 2.000
I40vectorDispRGBVecGainH	I40vectorDispVecGainTBL.4	DisplayString	R/W	0.2 to 2.000
I40vectorDispRGBVecGainV	I40vectorDispVecGainTBL.5	DisplayString	R/W	0.2 to 2.000
I40vectorDispYCbCrVecGainVar	I40vectorDispVecGainTBL.6	INTEGER	R/W	1 = cal 2 = variable
I40vectorDispYCbCrVecGainMag	I40vectorDispVecGainTBL.7	INTEGER	R/W	1 = x1 2 = x5
I40vectorDispYCbCrVecObsPoint	I40vectorDispVecGainTBL.8	INTEGER	R/W	1 = by-wh 2 = by-yl 3 = by-cy 4 = by-g 5 = by-timing 6 = by-mg 7 = by-r 8 = by-b 9 = bl 10 = ry-b 11 = ry-r 12 = ry-mg 13 = ry-timing 14 = ry-g 15 = ry-cy

20. NETWORK CONTROL

MIB	OID	SYNTAX	ACCESS	VALUE/RANGE
				16 = ry-yl 17 = ry-wh
I40vectorDispGuideDisplay	I40vectorDispVecGainTBL.9	INTEGER	R/W	1 = off 2 = on
I40vectorDispVecMarker	I40vectorDispVecTBL.3	INTEGER	R/W	1 = off 2 = on
I40vectorColorSystemTBL	I40vectorDispVecTBL.4	Aggregate	-	-
I40vectorColorSysMatrix	I40vectorColorSystemTBL.1	INTEGER	R/W	1 = component 2 = composite
I40vectorColorSysColorBar	I40vectorColorSystemTBL.2	INTEGER	R/W	1 = cb-100p 2 = cb75p
I40vectorColorSysCmpFormat	I40vectorColorSystemTBL.3	INTEGER	R/W	1 = auto 2 = ntsc 3 = pal
I40vectorColorSysSetup	I40vectorColorSystemTBL.4	INTEGER	R/W	1 = setup-0p 2 = setup-75p
I40vectorVariableMarkerTBL	I40vectorDispVecTBL.5	Aggregate	-	-
I40vectorVarMkrMarkerSize	I40vectorVariableMarkerTBL.4	INTEGER	R/W	5 to 10
I40vectorDisp5barTBL	I40vectorTBL.3	Aggregate	-	-
I40vectorDisp5barScale	I40vectorDisp5barTBL.1	INTEGER	R/W	1 = p 2 = mv 3 = hex 4 = dec
I40vectorDisp5barSeq	I40vectorDisp5barTBL.2	INTEGER	R/W	1 = gbr 2 = rgb
I40vectorDispHistTBL	I40vectorTBL.4	Aggregate	-	-
I40vectorDispHistScale	I40vectorDispHistTBL.1	INTEGER	R/W	1 = per 2 = hdr
I40vectorDispHistForm	I40vectorDispHistTBL.2	INTEGER	R/W	1 = single 2 = tile 3 = align-h 4 = align-v
I40vectorDispHistSetupTBL	I40vectorDispHistTBL.3	Aggregate	-	-
I40vectorDispHistSetupY	I40vectorDispHistSetupTBL.1	INTEGER	R/W	1 = off 2 = on
I40vectorDispHistSetupR	I40vectorDispHistSetupTBL.2	INTEGER	R/W	1 = off 2 = on
I40vectorDispHistSetupG	I40vectorDispHistSetupTBL.3	INTEGER	R/W	1 = off 2 = on
I40vectorDispHistSetupB	I40vectorDispHistSetupTBL.4	INTEGER	R/W	1 = off 2 = on
I40vectorDispCieTBL	I40vectorTBL.5	Aggregate	-	-
I40vectorDispCieScaleTBL	I40vectorDispCieTBL.1	Aggregate	-	-
I40vectorDispCieColor	I40vectorDispCieScaleTBL.1	INTEGER	R/W	1 = bg-white 2 = bg-color 3 = bg-black
I40vectorDispCieTriangle1	I40vectorDispCieScaleTBL.2	INTEGER	R/W	1 = off 2 = bt601-525 3 = bt601-625 4 = bt709 5 = dci 6 = bt2020
I40vectorDispCieTriangle2	I40vectorDispCieScaleTBL.3	INTEGER	R/W	1 = off 2 = bt601-525 3 = bt601-625 4 = bt709

20. NETWORK CONTROL

MIB	OID	SYNTAX	ACCESS	VALUE/RANGE
				5 = dci 6 = bt2020
I40vectorDispCieUserTriangle	I40vectorDispCieScaleTBL.4	INTEGER	R/W	1 = off 2 = one 3 = two
I40vectorDispCieUserPrimaryColor	I40vectorDispCieScaleTBL.5	INTEGER	R/W	1 = g 2 = b 3 = r
I40vectorDispCieUserTriangleX	I40vectorDispCieScaleTBL.6	DisplayString	R/W	0 to 1.000
I40vectorDispCieUserTriangleY	I40vectorDispCieScaleTBL.7	DisplayString	R/W	0 to 1.000
I40vectorDispCieTempScale	I40vectorDispCieScaleTBL.8	INTEGER	R/W	1 = off 2 = on
I40vectorDispCieGrid	I40vectorDispCieScaleTBL.9	INTEGER	R/W	1 = off 2 = on
I40vectorDispCieD65	I40vectorDispCieScaleTBL.10	INTEGER	R/W	1 = off 2 = on
I40vectorDispCieTriangleCaption	I40vectorDispCieScaleTBL.11	INTEGER	R/W	1 = off 2 = on
I40vectorDispCieWhitePointLabel	I40vectorDispCieScaleTBL.12	INTEGER	R/W	1 = off 2 = on
I40vectorDispCieSettingTBL	I40vectorDispCieTBL.2	Aggregate	-	-
I40vectorDispCieMode	I40vectorDispCieSettingTBL.1	INTEGER	R/W	1 = diagram 2 = temp
I40vectorDispCieStandard	I40vectorDispCieSettingTBL.2	INTEGER	R/W	5 = cie1391 6 = cie1976
I40vectorDispCieClip	I40vectorDispCieSettingTBL.3	INTEGER	R/W	1 = off 2 = on
I40vectorDispCieFilter	I40vectorDispCieSettingTBL.4	INTEGER	R/W	1 = off 2 = on
I40vectorDispCieManualSetup	I40vectorDispCieSettingTBL.5	INTEGER	R/W	1 = off 2 = on
I40vectorDispCieColorimetrySetup	I40vectorDispCieSettingTBL.6	INTEGER	R/W	1 = bt601-525 2 = bt601-625 3 = bt709 4 = dci 5 = bt2020
I40vectorDispCieGammaSetup	I40vectorDispCieSettingTBL.7	DisplayString	R/W	1.50 to 3.00
I40vectorDispCieCursor	I40vectorDispCieTBL.3	INTEGER	R/W	1 = off 2 = on
I40vectorLineselTBL	I40vectorTBL.6	Aggregate	-	-
I40vectorLinesel	I40vectorLineselTBL.1	INTEGER	R/W	1 = off 2 = on 3 = cinelite
I40vectorLineselNo	I40vectorLineselTBL.2	INTEGER	R/W	0 to 32767
I40vectorLineselField	I40vectorLineselTBL.3	INTEGER	R/W	1 = frame 2 = field1 3 = field2
I40vector5BarDataTBL	I40vectorTBL.7	Aggregate	-	-
I40vector5BarYData	I40vector5BarDataTBL.1	DisplayString	R/O	5Bar Max/Min
I40vector5BarGData	I40vector5BarDataTBL.2	DisplayString	R/O	5Bar Max/Min
I40vector5BarBData	I40vector5BarDataTBL.3	DisplayString	R/O	5Bar Max/Min
I40vector5BarRData	I40vector5BarDataTBL.4	DisplayString	R/O	5Bar Max/Min
I40vector5BarCmpData	I40vector5BarDataTBL.5	DisplayString	R/O	5Bar Max/Min

20. NETWORK CONTROL

• I40pictureTBL(5) group

MIB	OID	SYNTAX	ACCESS	VALUE/RANGE
I40pictureConfigTBL	I40pictureTBL.1	Aggregate	-	-
I40pictureMode	I40pictureConfigTBL.1	INTEGER	R/W	1 = fit 2 = real 3 = x2 4 = full
I40pictureAdjustTBL	I40pictureConfigTBL.2	Aggregate	-	-
I40pictureAdjustColor	I40pictureAdjustTBL.1	INTEGER	R/W	1 = color 2 = mono
I40pictureChroma	I40pictureAdjustTBL.2	INTEGER	R/W	1 = normal 2 = up
I40pictureBrightness	I40pictureAdjustTBL.3	DisplayString	R/W	-50.0 to 50.0
I40pictureContrast	I40pictureAdjustTBL.4	DisplayString	R/W	0 to 200.0
I40pictureGainR	I40pictureAdjustTBL.5	DisplayString	R/W	0 to 200.0
I40pictureGainG	I40pictureAdjustTBL.6	DisplayString	R/W	0 to 200.0
I40pictureGainB	I40pictureAdjustTBL.7	DisplayString	R/W	0 to 200.0
I40pictureGainChroma	I40pictureAdjustTBL.8	DisplayString	R/W	0 to 200.0
I40pictureBiasR	I40pictureAdjustTBL.9	DisplayString	R/W	-50.0 to 50.0
I40pictureBiasG	I40pictureAdjustTBL.10	DisplayString	R/W	-50.0 to 50.0
I40pictureBiasB	I40pictureAdjustTBL.11	DisplayString	R/W	-50.0 to 50.0
I40pictureDispGamut	I40pictureConfigTBL.3	INTEGER	R/W	1 = off 2 = white 3 = red 4 = mesh
I40pictureDispStatusInfo	I40pictureConfigTBL.4	INTEGER	R/W	1 = off 2 = on
I40pictureDisp3gbds	I40pictureConfigTBL.5	INTEGER	R/W	1 = Stream1 2 = Stream2 3 = Mix 4 = Align
I40pictureDispPosH	I40pictureConfigTBL.6	INTEGER	R/W	-32768 to 32767
I40pictureDispPosV	I40pictureConfigTBL.7	INTEGER	R/W	-32768 to 32767
I40pictureMarkerTBL	I40pictureConfigTBL.8	Aggregate	-	-
I40pictureMarkerFrame	I40pictureMarkerTBL.1	INTEGER	R/W	1 = off 2 = on
I40pictureMarkerCenter	I40pictureMarkerTBL.2	INTEGER	R/W	1 = off 2 = on
I40pictureMarkerAspect	I40pictureMarkerTBL.3	INTEGER	R/W	1 = off 2 = asp-17x9 3 = asp-16x9 4 = asp-14x9 5 = asp-13x9 6 = asp-4x3 7 = asp-239x1 8 = asp-afd
I40pictureAspectShadow	I40pictureMarkerTBL.4	INTEGER	R/W	0 to 100
I40pictureSafeAction	I40pictureMarkerTBL.5	INTEGER	R/W	1 = off 2 = arib 3 = smpte 4 = user
I40pictureSafeTitle	I40pictureMarkerTBL.6	INTEGER	R/W	1 = off 2 = arib 3 = smpte 4 = user
I40pictureSafeUser1Width	I40pictureMarkerTBL.7	INTEGER	R/W	0 to 100
I40pictureSafeUser1Height	I40pictureMarkerTBL.8	INTEGER	R/W	0 to 100

20. NETWORK CONTROL

MIB	OID	SYNTAX	ACCESS	VALUE/RANGE
I40pictureSafeUser2Width	I40pictureMarkerTBL.9	INTEGER	R/W	0 to 100
I40pictureSafeUser2Height	I40pictureMarkerTBL.10	INTEGER	R/W	0 to 100
I40pictureSafeUserAspect	I40pictureMarkerTBL.11	INTEGER	R/W	1 = off 2 = on
I40pictureSuperImposeTBL	I40pictureConfigTBL.9	Aggregate	-	-
I40pictureStandard	I40pictureSuperImposeTBL.1	INTEGER	R/W	1 = off 2 = smpte 3 = arib 4 = teletext
I40pictureSmpteFormat	I40pictureSuperImposeTBL.2	INTEGER	R/W	1 = fmt-608-708 2 = fmt-608-608 3 = fmt-vbi 4 = fmt-708
I40pictureSmpteLanguage	I40pictureSuperImposeTBL.3	INTEGER	R/W	1 = cc1 2 = cc2 3 = cc3 4 = cc4 5 = text1 6 = text2 7 = text3 8 = text4
I40pictureSmpte708Service	I40pictureSuperImposeTBL.4	INTEGER	R/W	1 to 63
I40pictureAribFormat	I40pictureSuperImposeTBL.5	INTEGER	R/W	1 = hd 2 = sd 3 = analog 4 = cellular
I40pictureAribLanguage	I40pictureSuperImposeTBL.6	INTEGER	R/W	1 = one 2 = two
I40pictureTeletextWst	I40pictureSuperImposeTBL.7	INTEGER	R/W	1 = vbi 2 = op47
I40pictureTeletextMagazin	I40pictureSuperImposeTBL.8	INTEGER	R/W	1 to 8
I40pictureTeletextPage	I40pictureSuperImposeTBL.9	INTEGER	R/W	0 to 255
I40pictureSmpteContent	I40pictureSuperImposeTBL.10	INTEGER	R/W	1 = off 2 = on
I40pictureCITBL	I40pictureTBL.2	Aggregate	-	-
I40pictureCIDisplay	I40pictureCITBL.1	INTEGER	R/W	1 = off 2 = fstop 3 = perdisplay 4 = cinezone 5 = perdiscpinezone
I40pictureCIAvance	I40pictureCITBL.2	INTEGER	R/W	1 = off 2 = on
I40pictureCIMeasureNums	I40pictureCITBL.3	INTEGER	R/W	1 = p1 2 = p1p2 3 = p1p2p3
I40pictureCIMeasurePos	I40pictureCITBL.4	INTEGER	R/W	1 = p1 2 = p2 3 = p3
I40pictureCIMeasureSize	I40pictureCITBL.5	INTEGER	R/W	1 = size-1x1 2 = size-3x3 3 = size-9x9
I40pictureCIUnit	I40pictureCITBL.6	INTEGER	R/W	1 = yper 2 = rgbper 3 = rgb255

20. NETWORK CONTROL

MIB	OID	SYNTAX	ACCESS	VALUE/RANGE
				4 = codevalue 5 = codevaluedec 6 = hdr
I40pictureCIFstopRefSet	I40pictureCITBL.7	INTEGER	R/WO	1 (fixed)
I40pictureCIFstopGammaSel	I40pictureCITBL.8	INTEGER	R/W	1 = gamma-045 2 = user1 3 = user2 4 = user3 5 = usera 6 = userb 7 = userc 8 = userd 9 = usere
I40pictureCISample	I40pictureCITBL.9	INTEGER	R/W	0 to 32767
I40pictureCILine	I40pictureCITBL.10	INTEGER	R/W	0 to 32767
I40pictureCICzTBL	I40pictureCLTBL.11	Aggregate	-	-
I40pictureCICzHdrZone	I40pictureCICzTBL.1	INTEGER	R/W	1 = off 2 = on
I40pictureCICzForm	I40pictureCICzTBL.2	INTEGER	R/W	1 = gradate 2 = step 3 = search
I40pictureCICzUpper	I40pictureCICzTBL.3	DisplayString	R/W	-6.3 to 109.4
I40pictureCICzLower	I40pictureCICzTBL.4	DisplayString	R/W	-7.3 to 108.4
I40pictureCICzRef	I40pictureCICzTBL.5	DisplayString	R/W	-7.3 to 109.4
I40pictureCICzLevel	I40pictureCICzTBL.6	DisplayString	R/W	-7.3 to 109.4
I40pictureMaxFallCIITBL	I40pictureTBL.3	Aggregate	-	-
I40pictureMaxFallCIIDisplay	I40pictureMaxFallCIITBLL .1	INTEGER	R/W	1 = off 2 = on
I40pictureMaxFallCIIMeasure	I40pictureMaxFallCIITBLL .2	INTEGER	R/W	1 = stop 2 = start
I40pictureMaxFallCIIClear	I40pictureMaxFallCIITBLL .3	INTEGER	R/WO	1 (fixed)
I40pictureEdgeTBL	I40pictureTBL.4	Aggregate	-	-
I40pictureEdgeDetect	I40pictureEdgeTBL.1	INTEGER	R/W	1 = off 2 = on
I40pictureEdgeSensitive	I40pictureEdgeTBL.2	INTEGER	R/W	1 = low 2 = middle 3 = high 4 = v-high 5 = u-high
I40pictureEdgeLevel	I40pictureEdgeTBL.3	INTEGER	R/W	1 = lvl-off 2 = lvl-25 3 = lvl-50 4 = lvl-75 5 = lvl-100 6 = lvl-emboss
I40pictureEdgeColor	I40pictureEdgeTBL.4	INTEGER	R/W	1 = white 4 = green 6 = red 7 = blue
I40pictureLineselTBL	I40pictureTBL.5	Aggregate	-	-
I40pictureLinesel	I40pictureLineselTBL.1	INTEGER	R/W	1 = off 2 = on 3 = cinelite
I40pictureLineselNo	I40pictureLineselTBL.2	INTEGER	R/W	0 to 32767
I40pictureLineselField	I40pictureLineselTBL.3	INTEGER	R/W	1 = frame 2 = field1

20. NETWORK CONTROL

MIB	OID	SYNTAX	ACCESS	VALUE/RANGE
				3 = field2
I40pictureDataTBL	I40pictureTBL.6	Aggregate	-	-
I40pictureDataCineliteP1	I40pictureDataTBL.1	DisplayString	R/O	Cinelite Data
I40pictureDataCineliteP2	I40pictureDataTBL.2	DisplayString	R/O	Cinelite Data
I40pictureDataCineliteP3	I40pictureDataTBL.3	DisplayString	R/O	Cinelite Data
I40pictureSnTBL	I40pictureTBL.7	Aggregate	-	
I40pictureSnNoise	I40pictureSnTBL.1	INTEGER	R/W	1 = stop 2 = start
I40pictureSnCh	I40pictureSnTBL.2	INTEGER	R/W	1 = a1 2 = a2 3 = track 4 = off
I40pictureSnSignal	I40pictureSnTBL.3	INTEGER	R/W	1 = y 2 = g 3 = b 4 = r
I40pictureSnLpf	I40pictureSnTBL.4	INTEGER	R/W	1 = f_0_404 2 = f_0_323 3 = f_0_269 4 = f_0_202 5 = f_0_101 6 = f_0_0505 7 = through
I40pictureSnSize	I40pictureSnTBL.5	INTEGER	R/W	1 = small 2 = large
I40pictureSnHpf	I40pictureSnTBL.6	INTEGER	R/W	1 = on 2 = off
I40pictureSnBar	I40pictureSnTBL.7	INTEGER	R/W	1 = on 2 = off
I40pictureSnAlertUnit	I40pictureSnTBL.8	INTEGER	R/W	1 = on 2 = off
I40pictureSnAlertLevel	I40pictureSnTBL.9	DisplayString	R/W	-80 to 0
I40pictureSnDataDb	I40pictureSnTBL.10	DisplayString	R/O	Sn Data
I40pictureSnDataMv	I40pictureSnTBL.11	DisplayString	R/O	Sn Data

20. NETWORK CONTROL

• I40statusTBL(6) group

MIB	OID	SYNTAX	ACCESS	VALUE/RANGE
I40statusModeTBL	I40statusTBL.1	Aggregate	-	-
I40statusModeTop	I40statusModeTBL.1	INTEGER	R/WO	1 (fixed)
I40statusModeDump	I40statusModeTBL.2	INTEGER	R/WO	1 (fixed)
I40statusModeExtref	I40statusModeTBL.3	INTEGER	R/WO	1 (fixed)
I40statusModeAvPhase	I40statusModeTBL.4	INTEGER	R/WO	1 (fixed)
I40statusModeAncView	I40statusModeTBL.5	INTEGER	R/WO	1 (fixed)
I40statusModeAncViewDump	I40statusModeTBL.6	INTEGER	R/WO	1 (fixed)
I40statusModeLog	I40statusModeTBL.7	INTEGER	R/WO	1 (fixed)
I40statusModeAncPkt	I40statusModeTBL.8	INTEGER	R/WO	1 (fixed)
I40statusModeEdh	I40statusModeTBL.9	INTEGER	R/WO	1 (fixed)
I40statusModePayload	I40statusModeTBL.10	INTEGER	R/WO	1 (fixed)
I40statusModeCtrlPkt	I40statusModeTBL.11	INTEGER	R/WO	1 (fixed)
I40statusModeAribCc	I40statusModeTBL.12	INTEGER	R/WO	1 (fixed)
I40statusAribNetq	I40statusModeTBL.13	INTEGER	R/WO	1 (fixed)
I40statusModeAribTrig	I40statusModeTBL.14	INTEGER	R/WO	1 (fixed)
I40statusModeAribUser1	I40statusModeTBL.15	INTEGER	R/WO	1 (fixed)
I40statusModeAribUser2	I40statusModeTBL.16	INTEGER	R/WO	1 (fixed)
I40statusModeSmpte608	I40statusModeTBL.17	INTEGER	R/WO	1 (fixed)
I40statusModeSmpte708	I40statusModeTBL.18	INTEGER	R/WO	1 (fixed)
I40statusModeSmpteAfd	I40statusModeTBL.19	INTEGER	R/WO	1 (fixed)
I40statusModeSmpteProg	I40statusModeTBL.20	INTEGER	R/WO	1 (fixed)
I40statusModeSmpteVbi	I40statusModeTBL.21	INTEGER	R/WO	1 (fixed)
I40statusModeSearch	I40statusModeTBL.22	INTEGER	R/WO	1 (fixed)
I40statusModeErrClear	I40statusModeTBL.23	INTEGER	R/WO	1 (fixed)
I40statusModeIp	I40statusModeTBL.24	INTEGER	R/WO	1 (fixed)
I40statusModeIpJitter	I40statusModeTBL.25	INTEGER	R/WO	1 (fixed)
I40statusModeIpPtp	I40statusModeTBL.26	INTEGER	R/WO	1 (fixed)
I40statusModeIpInfoSfp	I40statusModeTBL.27	INTEGER	R/WO	1 (fixed)
I40statusModeIpInfoVideo	I40statusModeTBL.28	INTEGER	R/WO	1 (fixed)
I40statusModeIpInfoNmos	I40statusModeTBL.29	INTEGER	R/WO	1 (fixed)
I40statusModeIpPtpMessage	I40statusModeTBL.30	INTEGER	R/WO	1 (fixed)
I40statusModeIpPtpDiff	I40statusModeTBL.31	INTEGER	R/WO	1 (fixed)
I40statusModeIpWdly	I40statusModeTBL.32	INTEGER	R/WO	1 (fixed)
I40statusModeSmpteSrLive	I40statusModeTBL.33	INTEGER	R/WO	1 (fixed)
I40statusModeSmpteScte104	I40statusModeTBL.34	INTEGER	R/WO	1 (fixed)
I40statusModeIpBuffer	I40statusModeTBL.36	INTEGER	R/WO	1 (fixed)
I40statusModeIpNmos	I40statusModeTBL.37	INTEGER	R/WO	1 (fixed)
I40statusModeIpJxsStatus	I40statusModeTBL.38	INTEGER	R/WO	1 (fixed)
I40statusModeIpJxsHeader	I40statusModeTBL.39	INTEGER	R/WO	1 (fixed)
I40statusModeIpFormat	I40statusModeTBL.40	INTEGER	R/WO	1 (fixed)
I40statusLogTBL	I40statusTBL.2	Aggregate	-	-
I40statusLogging	I40statusLogTBL.1	INTEGER	R/W	1 = stop 2 = start
I40statusLogMode	I40statusLogTBL.2	INTEGER	R/W	1 = overwrt 2 = stop
I40statusLogClear	I40statusLogTBL.3	INTEGER	R/WO	1 (fixed)
I40statusDumpTBL	I40statusTBL.3	Aggregate	-	-
I40statusDumpMode	I40statusDumpTBL.1	INTEGER	R/W	1 = run 2 = hold
I40statusDumpModeCap	I40statusDumpTBL.2	INTEGER	R/W	1 = run 2 = hold 3 = frmcap
I40statusDumpDisp	I40statusDumpTBL.3	INTEGER	R/W	1 = serial 2 = compo 3 = binary

20. NETWORK CONTROL

MIB	OID	SYNTAX	ACCESS	VALUE/RANGE
				7 = stream1 8 = stream2 9 = stream12-pic 10 = s1serial 11 = s1compo 12 = s1binary 13 = s2serial 14 = s2compo 15 = s2binary
I40statusDumpJump	I40statusDumpTBL.4	INTEGER	R/W	1 = eav 2 = sav
I40statusDumpSample	I40statusDumpTBL.5	INTEGER	R/W	0 to 32767
I40statusDumpLine	I40statusDumpTBL.6	INTEGER	R/W	0 to 32767
I40statusDumpLinkSelect	I40statusDumpTBL.7	INTEGER	R/W	1 = picture 2 = a 3 = b 4 = c 5 = d
I40statusExtrefTBL	I40statusTBL.4	Aggregate	-	-
I40statusExtrefSel	I40statusExtrefTBL.3	INTEGER	R/W	1 = ext 2 = sdi
I40statusExtrefUserRef	I40statusExtrefTBL.1	INTEGER	R/WO	1 (fixed)
I40statusExtrefDefaultRef	I40statusExtrefTBL.2	INTEGER	R/WO	1 (fixed)
I40statusExtrefTiming	I40statusExtrefTBL.4	INTEGER	R/W	1 = legacy 2 = serial
I40statusAvPhaseTBL	I40statusTBL.5	Aggregate	-	-
I40statusAvPhaseScaleMax	I40statusAvphaseTBL.1	INTEGER	R/W	1 = scale-50ms 2 = scale-100ms 3 = scale-500ms 4 = scale-1000ms 5 = scale-2500ms
I40statusAvPhaseRefresh	I40statusAvphaseTBL.2	INTEGER	R/WO	1 (fixed)
I40statusAncTBL	I40statusTBL.6	Aggregate	-	-
I40statusAncDumpHold	I40statusAncTBL.1	INTEGER	R/W	1 = hold-hold 2 = hold-1s 3 = hold-3s
I40statusAncDumpMode	I40statusAncTBL.2	INTEGER	R/W	1 = hex 2 = binary
I40statusAncDumpSample	I40statusAncTBL.3	INTEGER	R/W	0 to 258
I40statusAncEdhDisp	I40statusAncTBL.4	INTEGER	R/W	1 = text 2 = dump
I40statusAncEdhMode	I40statusAncTBL.5	INTEGER	R/W	1 = hex 2 = binary
I40statusAncEdhSample	I40statusAncTBL.6	INTEGER	R/W	0 to 19
I40statusAncViewStream	I40statusAncTBL.7	INTEGER	R/W	1 = stream1 2 = stream2
I40statusAncPayloadStream	I40statusAncTBL.8	INTEGER	R/W	1 = stream1 2 = stream2
I40statusAncCtrlDisp	I40statusAncTBL.9	INTEGER	R/W	1 = text 2 = dump
I40statusAncCtrlMode	I40statusAncTBL.10	INTEGER	R/W	1 = hex 2 = binary
I40statusAncCtrlGroup	I40statusAncTBL.11	INTEGER	R/W	1 = group1 2 = group2 3 = group3 4 = group4
I40statusAncCtrlStream	I40statusAncTBL.12	INTEGER	R/W	1 = stream1

20. NETWORK CONTROL

MIB	OID	SYNTAX	ACCESS	VALUE/RANGE
				2 = stream2
I40statusAncLinkSelect	I40statusAncTBL.13	INTEGER	R/W	1 = a 2 = b 3 = c 4 = d
I40statusAribTBL	I40statusTBL.7	Aggregate	-	-
I40statusAribCcDisp	I40statusAribTBL.1	INTEGER	R/W	1 = text 2 = dump
I40statusAribCcType	I40statusAribTBL.2	INTEGER	R/W	1 = hd 2 = sd 3 = analog 4 = cellular
I40statusAribCcMode	I40statusAribTBL.3	INTEGER	R/W	1 = hex 2 = binary
I40statusAribCcSample	I40statusAribTBL.4	INTEGER	R/W	0 to 258
I40statusAribCcStream	I40statusAribTBL.5	INTEGER	R/W	1 = stream1 2 = stream2
I40statusAribNetqDisp	I40statusAribTBL.6	INTEGER	R/W	1 = text 2 = dump 3 = qlog 4 = format
I40statusAribNetqMode	I40statusAribTBL.7	INTEGER	R/W	1 = hex 2 = binary
I40statusAribNetqSample	I40statusAribTBL.8	INTEGER	R/W	0 to 258
I40statusAribNetqLogPos	I40statusAribTBL.9	INTEGER	R/W	-50 to 50
I40statusAribNetqStream	I40statusAribTBL.10	INTEGER	R/W	1 = stream1 2 = stream2
I40statusAribNetqClear	I40statusAribTBL.11	INTEGER	R/WO	1 (fixed)
I40statusAribTriggerDisp	I40statusAribTBL.12	INTEGER	R/W	1 = text 2 = dump
I40statusAribTriggerMode	I40statusAribTBL.13	INTEGER	R/W	1 = hex 2 = binary
I40statusAribTriggerSample	I40statusAribTBL.14	INTEGER	R/W	0 to 258
I40statusAribTriggerStream	I40statusAribTBL.15	INTEGER	R/W	1 = stream1 2 = stream2
I40statusAribTriggerUser1Mode	I40statusAribTBL.16	INTEGER	R/W	1 = hex 2 = binary
I40statusAribTriggerUser1Sample	I40statusAribTBL.17	INTEGER	R/W	0 to 258
I40statusAribTriggerUser1Stream	I40statusAribTBL.18	INTEGER	R/W	1 = stream1 2 = stream2
I40statusAribTriggerUser2Mode	I40statusAribTBL.19	INTEGER	R/W	1 = hex 2 = binary
I40statusAribTriggerUser2Sample	I40statusAribTBL.20	INTEGER	R/W	0 to 258
I40statusAribTriggerUser2Stream	I40statusAribTBL.21	INTEGER	R/W	1 = stream1 2 = stream2
I40statusSmpteTBL	I40statusTBL.8	Aggregate	-	-
I40statusSmpte608Disp	I40statusSmpteTBL.1	INTEGER	R/W	1 = text 2 = dump
I40statusSmpte608Mode	I40statusSmpteTBL.2	INTEGER	R/W	1 = hex 2 = binary
I40statusSmpte608Sample	I40statusSmpteTBL.3	INTEGER	R/W	0 to 258
I40statusSmpte608Stream	I40statusSmpteTBL.4	INTEGER	R/W	1 = stream1 2 = stream2
I40statusSmpte708Disp	I40statusSmpteTBL.5	INTEGER	R/W	1 = text 2 = dump

20. NETWORK CONTROL

MIB	OID	SYNTAX	ACCESS	VALUE/RANGE
I40statusSmpte708Mode	I40statusSmpteTBL.6	INTEGER	R/W	1 = hex 2 = binary
I40statusSmpte708Sample	I40statusSmpteTBL.7	INTEGER	R/W	0 to 258
I40statusSmpte708Stream	I40statusSmpteTBL.8	INTEGER	R/W	1 = stream1 2 = stream2
I40statusSmpteProgStream	I40statusSmpteTBL.9	INTEGER	R/W	1 = stream1 2 = stream2
I40statusSmpteVbiStream	I40statusSmpteTBL.10	INTEGER	R/W	1 = stream1 2 = stream2
I40statusSmpteAfdDisp	I40statusSmpteTBL.11	INTEGER	R/W	1 = text 2 = dump
I40statusSmpteAfdMode	I40statusSmpteTBL.12	INTEGER	R/W	1 = hex 2 = binary
I40statusSmpteAfdStream	I40statusSmpteTBL.13	INTEGER	R/W	1 = stream1 2 = stream2
I40statusSmpteSrLiveDisp	I40statusSmpteTBL.14	INTEGER	R/W	1 = text 2 = dump
I40statusSmpteSrLiveMode	I40statusSmpteTBL.15	INTEGER	R/W	1 = hex 2 = binary
I40statusSmpteSrLiveSample	I40statusSmpteTBL.16	INTEGER	R/W	0 to 258
I40statusSmpteSrLiveStream	I40statusSmpteTBL.17	INTEGER	R/W	1 = stream1 2 = stream2
I40statusSmpteScte104LogClear	I40statusSmpteTBL.18	INTEGER	R/WO	1 (fixed)
I40statusSmpteScte104LogPos	I40statusSmpteTBL.19	INTEGER	R/W	-50 to 50
I40statusSmpteScte104Disp	I40statusSmpteTBL.20	INTEGER	R/W	1 = text 2 = dump 3 = splice
I40statusSmpteScte104Mode	I40statusSmpteTBL.21	INTEGER	R/W	1 = hex 2 = binary
I40statusSmpteScte104Logging	I40statusSmpteTBL.22	INTEGER	R/W	1 = stop 2 = start
I40statusSmpteScte104Sample	I40statusSmpteTBL.23	INTEGER	R/W	0 to 258
I40statusSmpteScte104TextDuration	I40statusSmpteTBL.24	INTEGER	R/W	1 to 10
I40statusSmpteScte104DumpDuration	I40statusSmpteTBL.25	INTEGER	R/W	1 = duration-hold 2 = duration-1s 3 = duration-3s
I40statusSmpteScte104IdValue	I40statusSmpteTBL.26	INTEGER	R/W	1 = dec 2 = hex 3 = both
I40statusCustomTBL	I40statusTBL.9	Aggregate	-	-
I40statusCustomSearchDid	I40statusCustomTBL.1	DisplayString	R/W	0 to FF
I40statusCustomSearchSdid	I40statusCustomTBL.2	DisplayString	R/W	-1 to FF
I40statusCustomSearchMode	I40statusCustomTBL.3	INTEGER	R/W	1 = hex 2 = binary
I40statusCustomSearchYc	I40statusCustomTBL.4	INTEGER	R/W	1 = y 2 = c
I40statusCustomSearchStream	I40statusCustomTBL.5	INTEGER	R/W	1 = stream1 2 = stream2
I40statusCustomSearchSet	I40statusCustomTBL.6	INTEGER	R/WO	1 (fixed)
I40statusCustomSearchSample	I40statusCustomTBL.7	INTEGER	R/W	0 to 258
I40statusDataTBL	I40statusTBL.10	Aggregate	-	-
I40statusDataSignalA	I40statusDataTBL.1	DisplayString	R/O	Signal Data
I40statusDataSignalB	I40statusDataTBL.2	DisplayString	R/O	Signal Data
I40statusDataSignalC	I40statusDataTBL.3	DisplayString	R/O	Signal Data
I40statusDataSignalD	I40statusDataTBL.4	DisplayString	R/O	Signal Data

20. NETWORK CONTROL

MIB	OID	SYNTAX	ACCESS	VALUE/RANGE
I40statusDataLinkA	I40statusDataTBL.5	DisplayString	R/O	Link Data
I40statusDataLinkB	I40statusDataTBL.6	DisplayString	R/O	Link Data
I40statusDataLinkC	I40statusDataTBL.7	DisplayString	R/O	Link Data
I40statusDataLinkD	I40statusDataTBL.8	DisplayString	R/O	Link Data
I40statusDataFormatA	I40statusDataTBL.9	DisplayString	R/O	Format Data
I40statusDataFormatB	I40statusDataTBL.10	DisplayString	R/O	Format Data
I40statusDataFormatC	I40statusDataTBL.11	DisplayString	R/O	Format Data
I40statusDataFormatD	I40statusDataTBL.12	DisplayString	R/O	Format Data
I40statusDataAudioA	I40statusDataTBL.13	DisplayString	R/O	Audio Data
I40statusDataAudioB	I40statusDataTBL.14	DisplayString	R/O	Audio Data
I40statusDataAudioC	I40statusDataTBL.15	DisplayString	R/O	Audio Data
I40statusDataAudioD	I40statusDataTBL.16	DisplayString	R/O	Audio Data
I40statusDataExtrefA	I40statusDataTBL.17	INTEGER	R/O	1 = userref 2 = default
I40statusDataExtrefStatA	I40statusDataTBL.18	INTEGER	R/O	1 = int 2 = sdi1a 3 = sdi2a 4 = sdi1c 5 = sdi2c 6 = linkA 7 = link1 8 = exthd 9 = extbb 10 = normal
I40statusDataExtrefHtimeA	I40statusDataTBL.19	DisplayString	R/O	H Phase [us]
I40statusDataExtrefHpixA	I40statusDataTBL.20	DisplayString	R/O	H Phase [pix/dot]
I40statusDataExtrefVlineA	I40statusDataTBL.21	DisplayString	R/O	V Phase
I40statusDataExtrefTotalA	I40statusDataTBL.22	DisplayString	R/O	Total Phase
I40statusDataExtrefB	I40statusDataTBL.23	INTEGER	R/O	1 = userref 2 = default
I40statusDataExtrefStatB	I40statusDataTBL.24	INTEGER	R/O	1 = int 2 = sdi1a 3 = sdi2a 4 = sdi1c 5 = sdi2c 6 = linkA 7 = link1 8 = exthd 9 = extbb 10 = nosignal
I40statusDataExtrefHtimeB	I40statusDataTBL.25	DisplayString	R/O	H Phase [us]
I40statusDataExtrefHpixB	I40statusDataTBL.26	DisplayString	R/O	H Phase [pix/dot]
I40statusDataExtrefVlineB	I40statusDataTBL.27	DisplayString	R/O	V Phase
I40statusDataExtrefTotalB	I40statusDataTBL.28	DisplayString	R/O	Total Phase
I40statusDataExtrefC	I40statusDataTBL.29	INTEGER	R/O	1 = userref 2 = default
I40statusDataExtrefStatC	I40statusDataTBL40	INTEGER	R/O	1 = int 2 = sdi1a 3 = sdi2a 4 = sdi1c 5 = sdi2c 6 = linkA 7 = link1 8 = exthd 9 = extbb 10 = normal
I40statusDataExtrefHtimeC	I40statusDataTBL.31	DisplayString	R/O	H Phase [us]

20. NETWORK CONTROL

MIB	OID	SYNTAX	ACCESS	VALUE/RANGE
I40statusDataExtrefHpixC	I40statusDataTBL.32	DisplayString	R/O	H Phase [pix/dot]
I40statusDataExtrefVlineC	I40statusDataTBL.33	DisplayString	R/O	V Phase
I40statusDataExtrefTotalC	I40statusDataTBL.34	DisplayString	R/O	Total Phase
I40statusDataExtrefD	I40statusDataTBL.35	INTEGER	R/O	1 = userref 2 = default
I40statusDataExtrefStatD	I40statusDataTBL.36	INTEGER	R/O	1 = int 2 = sdi1a 3 = sdi2a 4 = sdi1c 5 = sdi2c 6 = linkA 7 = link1 8 = exthd 9 = extbb 10 = normal
I40statusDataExtrefHtimeD	I40statusDataTBL.37	DisplayString	R/O	H Phase [us]
I40statusDataExtrefHpixD	I40statusDataTBL.38	DisplayString	R/O	H Phase [pix/dot]
I40statusDataExtrefVlineD	I40statusDataTBL.39	DisplayString	R/O	V Phase
I40statusDataExtrefTotalD	I40statusDataTBL.40	DisplayString	R/O	Total Phase
I40statusDataAncAudioCtrl1	I40statusDataTBL.41	INTEGER	R/O	1 = detect 2 = missing
I40statusDataAncAudioCtrl2	I40statusDataTBL.42	INTEGER	R/O	1 = detect 2 = missing
I40statusDataAncEdh	I40statusDataTBL.43	INTEGER	R/O	1 = detect 2 = missing
I40statusDataAncLtc1	I40statusDataTBL.44	INTEGER	R/O	1 = detect 2 = missing
I40statusDataAncLtc2	I40statusDataTBL.45	INTEGER	R/O	1 = detect 2 = missing
I40statusDataAncVitc1	I40statusDataTBL.46	INTEGER	R/O	1 = detect 2 = missing
I40statusDataAncVitc2	I40statusDataTBL.47	INTEGER	R/O	1 = detect 2 = missing
I40statusDataAncPayload1	I40statusDataTBL.48	INTEGER	R/O	1 = detect 2 = missing
I40statusDataAncPayload2	I40statusDataTBL.49	INTEGER	R/O	1 = detect 2 = missing
I40statusDataAncEia708708	I40statusDataTBL.50	INTEGER	R/O	1 = detect 2 = missing
I40statusDataAncEia708608	I40statusDataTBL.51	INTEGER	R/O	1 = detect 2 = missing
I40statusDataAncEia608	I40statusDataTBL.52	INTEGER	R/O	1 = detect 2 = missing
I40statusDataAncProgram	I40statusDataTBL.53	INTEGER	R/O	1 = detect 2 = missing
I40statusDataAncBroadcast	I40statusDataTBL.54	INTEGER	R/O	1 = detect 2 = missing
I40statusDataAncVbi	I40statusDataTBL.55	INTEGER	R/O	1 = detect 2 = missing
I40statusDataAncAfd1	I40statusDataTBL.56	INTEGER	R/O	1 = detect 2 = missing
I40statusDataAncAfd2	I40statusDataTBL.57	INTEGER	R/O	1 = detect 2 = missing
I40statusDataAncJpnCc1	I40statusDataTBL.58	INTEGER	R/O	1 = detect 2 = missing
I40statusDataAncJpnCc2	I40statusDataTBL.59	INTEGER	R/O	1 = detect 2 = missing

20. NETWORK CONTROL

MIB	OID	SYNTAX	ACCESS	VALUE/RANGE
I40statusDataAncJpnCc3	I40statusDataTBL.60	INTEGER	R/O	1 = detect 2 = missing
I40statusDataAncNetq1	I40statusDataTBL.61	INTEGER	R/O	1 = detect 2 = missing
I40statusDataAncNetq2	I40statusDataTBL.62	INTEGER	R/O	1 = detect 2 = missing
I40statusDataAncTrigger	I40statusDataTBL.63	INTEGER	R/O	1 = detect 2 = missing
I40statusDataAncUser1	I40statusDataTBL.64	INTEGER	R/O	1 = detect 2 = missing
I40statusDataAncUser2	I40statusDataTBL.65	INTEGER	R/O	1 = detect 2 = missing
I40statusDataAncPktPayload	I40statusDataTBL.66	DisplayString	R/O	Payload ID
I40statusDataAncPktAribNetqS tation	I40statusDataTBL.67	DisplayString	R/O	Station Code
I40statusDataAncPktAribNetqV curr	I40statusDataTBL.68	DisplayString	R/O	Video Current
I40statusDataAncPktAribNetqV Next	I40statusDataTBL.69	DisplayString	R/O	Video Next
I40statusDataAncPktAribNetqA Curr	I40statusDataTBL.70	DisplayString	R/O	Audio Current
I40statusDataAncPktAribNetqA Next	I40statusDataTBL.71	DisplayString	R/O	Audio Next
I40statusDataAncPktAribNetqD Curr	I40statusDataTBL.72	DisplayString	R/O	Downmix Current
I40statusDataAncPktAribNetqD Next	I40statusDataTBL.73	DisplayString	R/O	Downmix Next
I40statusDataAncPktSmpteAfd Code	I40statusDataTBL.74	DisplayString	R/O	AFD Code
I40statusDataAncPktSmpteAfd Frame	I40statusDataTBL.75	DisplayString	R/O	Coded Frame
I40statusDataAncPktSmpteAfd BarFlg	I40statusDataTBL.76	DisplayString	R/O	Bar Data Flags
I40statusDataAncPktSmpteAfd BarVal1	I40statusDataTBL.77	DisplayString	R/O	Bar Data Value1
I40statusDataAncPktSmpteAfd BarVal2	I40statusDataTBL.78	DisplayString	R/O	Bar Data Value2
I40statusDataFreqDev	I40statusDataTBL.79	DisplayString	R/O	<-100ppm, -100 to +100ppm, >+100ppm
I40statusDataFreqDevA	I40statusDataTBL.80	DisplayString	R/O	<-100ppm, -100 to +100ppm, >+100ppm
I40statusDataFreqDevB	I40statusDataTBL.81	DisplayString	R/O	<-100ppm, -100 to +100ppm, >+100ppm
I40statusDataFreqDevC	I40statusDataTBL.82	DisplayString	R/O	<-100ppm, -100 to +100ppm, >+100ppm
I40statusDataFreqDevD	I40statusDataTBL.83	DisplayString	R/O	<-100ppm, -100 to +100ppm, >+100ppm
I40statusDataAvPhaseMsCh1	I40statusDataTBL.84	DisplayString	R/O	AvPhase CH1 MS
I40statusDataAvPhaseMsCh2	I40statusDataTBL.85	DisplayString	R/O	AvPhase CH2 MS
I40statusDataAvPhaseMsCh3	I40statusDataTBL.86	DisplayString	R/O	AvPhase CH3 MS
I40statusDataAvPhaseMsCh4	I40statusDataTBL.87	DisplayString	R/O	AvPhase CH4 MS
I40statusDataAvPhaseMsCh5	I40statusDataTBL.88	DisplayString	R/O	AvPhase CH5 MS
I40statusDataAvPhaseMsCh6	I40statusDataTBL.89	DisplayString	R/O	AvPhase CH6 MS
I40statusDataAvPhaseMsCh7	I40statusDataTBL.90	DisplayString	R/O	AvPhase CH7 MS
I40statusDataAvPhaseMsCh8	I40statusDataTBL.91	DisplayString	R/O	AvPhase CH8 MS
I40statusDataAvPhaseMsCh9	I40statusDataTBL.92	DisplayString	R/O	AvPhase CH9 MS
I40statusDataAvPhaseMsCh10	I40statusDataTBL.93	DisplayString	R/O	AvPhase CH10 MS

20. NETWORK CONTROL

MIB	OID	SYNTAX	ACCESS	VALUE/RANGE
I40statusDataAvPhaseMsCh11	I40statusDataTBL.94	DisplayString	R/O	AvPhase CH11 MS
I40statusDataAvPhaseMsCh12	I40statusDataTBL.95	DisplayString	R/O	AvPhase CH12 MS
I40statusDataAvPhaseMsCh13	I40statusDataTBL.96	DisplayString	R/O	AvPhase CH13 MS
I40statusDataAvPhaseMsCh14	I40statusDataTBL.97	DisplayString	R/O	AvPhase CH14 MS
I40statusDataAvPhaseMsCh15	I40statusDataTBL.98	DisplayString	R/O	AvPhase CH15 MS
I40statusDataAvPhaseMsCh16	I40statusDataTBL.99	DisplayString	R/O	AvPhase CH16 MS
I40statusDataAvPhaseFrmCh1	I40statusDataTBL.100	DisplayString	R/O	AvPhase CH1 FRM
I40statusDataAvPhaseFrmCh2	I40statusDataTBL.101	DisplayString	R/O	AvPhase CH2 FRM
I40statusDataAvPhaseFrmCh3	I40statusDataTBL.102	DisplayString	R/O	AvPhase CH3 FRM
I40statusDataAvPhaseFrmCh4	I40statusDataTBL.103	DisplayString	R/O	AvPhase CH4 FRM
I40statusDataAvPhaseFrmCh5	I40statusDataTBL.104	DisplayString	R/O	AvPhase CH5 FRM
I40statusDataAvPhaseFrmCh6	I40statusDataTBL.105	DisplayString	R/O	AvPhase CH6 FRM
I40statusDataAvPhaseFrmCh7	I40statusDataTBL.106	DisplayString	R/O	AvPhase CH7 FRM
I40statusDataAvPhaseFrmCh8	I40statusDataTBL.107	DisplayString	R/O	AvPhase CH8 FRM
I40statusDataAvPhaseFrmCh9	I40statusDataTBL.108	DisplayString	R/O	AvPhase CH9 FRM
I40statusDataAvPhaseFrmCh10	I40statusDataTBL.109	DisplayString	R/O	AvPhase CH10 FRM
I40statusDataAvPhaseFrmCh11	I40statusDataTBL.110	DisplayString	R/O	AvPhase CH11 FRM
I40statusDataAvPhaseFrmCh12	I40statusDataTBL.111	DisplayString	R/O	AvPhase CH12 FRM
I40statusDataAvPhaseFrmCh13	I40statusDataTBL.112	DisplayString	R/O	AvPhase CH13 FRM
I40statusDataAvPhaseFrmCh14	I40statusDataTBL.113	DisplayString	R/O	AvPhase CH14 FRM
I40statusDataAvPhaseFrmCh15	I40statusDataTBL.114	DisplayString	R/O	AvPhase CH15 FRM
I40statusDataAvPhaseFrmCh16	I40statusDataTBL.115	DisplayString	R/O	AvPhase CH16 FRM
I40statusDataAncAudioCtrl1A	I40statusDataTBL.116	INTEGER	R/O	1 = detect 2 = missing
I40statusDataAncAudioCtrl1B	I40statusDataTBL.117	INTEGER	R/O	1 = detect 2 = missing
I40statusDataAncAudioCtrl1C	I40statusDataTBL.118	INTEGER	R/O	1 = detect 2 = missing
I40statusDataAncAudioCtrl1D	I40statusDataTBL.119	INTEGER	R/O	1 = detect 2 = missing
I40statusDataAncAudioCtrl2A	I40statusDataTBL.120	INTEGER	R/O	1 = detect 2 = missing
I40statusDataAncAudioCtrl2B	I40statusDataTBL.121	INTEGER	R/O	1 = detect 2 = missing
I40statusDataAncAudioCtrl2C	I40statusDataTBL.122	INTEGER	R/O	1 = detect 2 = missing
I40statusDataAncAudioCtrl2D	I40statusDataTBL.123	INTEGER	R/O	1 = detect 2 = missing
I40statusDataAncEdhA	I40statusDataTBL.124	INTEGER	R/O	1 = detect 2 = missing
I40statusDataAncEdhB	I40statusDataTBL.125	INTEGER	R/O	1 = detect 2 = missing
I40statusDataAncEdhC	I40statusDataTBL.126	INTEGER	R/O	1 = detect 2 = missing
I40statusDataAncEdhD	I40statusDataTBL.127	INTEGER	R/O	1 = detect 2 = missing
I40statusDataAncLtc1A	I40statusDataTBL.128	INTEGER	R/O	1 = detect 2 = missing
I40statusDataAncLtc1B	I40statusDataTBL.129	INTEGER	R/O	1 = detect 2 = missing

20. NETWORK CONTROL

MIB	OID	SYNTAX	ACCESS	VALUE/RANGE
I40statusDataAncLtc1C	I40statusDataTBL.130	INTEGER	R/O	1 = detect 2 = missing
I40statusDataAncLtc1D	I40statusDataTBL.131	INTEGER	R/O	1 = detect 2 = missing
I40statusDataAncLtc2A	I40statusDataTBL.132	INTEGER	R/O	1 = detect 2 = missing
I40statusDataAncLtc2B	I40statusDataTBL.133	INTEGER	R/O	1 = detect 2 = missing
I40statusDataAncLtc2C	I40statusDataTBL.134	INTEGER	R/O	1 = detect 2 = missing
I40statusDataAncLtc2D	I40statusDataTBL.135	INTEGER	R/O	1 = detect 2 = missing
I40statusDataAncVitc1A	I40statusDataTBL.136	INTEGER	R/O	1 = detect 2 = missing
I40statusDataAncVitc1B	I40statusDataTBL.137	INTEGER	R/O	1 = detect 2 = missing
I40statusDataAncVitc1C	I40statusDataTBL.138	INTEGER	R/O	1 = detect 2 = missing
I40statusDataAncVitc1D	I40statusDataTBL.139	INTEGER	R/O	1 = detect 2 = missing
I40statusDataAncVitc2A	I40statusDataTBL.140	INTEGER	R/O	1 = detect 2 = missing
I40statusDataAncVitc2B	I40statusDataTBL.141	INTEGER	R/O	1 = detect 2 = missing
I40statusDataAncVitc2C	I40statusDataTBL.142	INTEGER	R/O	1 = detect 2 = missing
I40statusDataAncVitc2D	I40statusDataTBL.143	INTEGER	R/O	1 = detect 2 = missing
I40statusDataAncPayload1A	I40statusDataTBL.144	INTEGER	R/O	1 = detect 2 = missing
I40statusDataAncPayload1B	I40statusDataTBL.145	INTEGER	R/O	1 = detect 2 = missing
I40statusDataAncPayload1C	I40statusDataTBL.146	INTEGER	R/O	1 = detect 2 = missing
I40statusDataAncPayload1D	I40statusDataTBL.147	INTEGER	R/O	1 = detect 2 = missing
I40statusDataAncPayload2A	I40statusDataTBL.148	INTEGER	R/O	1 = detect 2 = missing
I40statusDataAncPayload2B	I40statusDataTBL.149	INTEGER	R/O	1 = detect 2 = missing
I40statusDataAncPayload2C	I40statusDataTBL.150	INTEGER	R/O	1 = detect 2 = missing
I40statusDataAncPayload2D	I40statusDataTBL.151	INTEGER	R/O	1 = detect 2 = missing
I40statusDataAncEia708708A	I40statusDataTBL.152	INTEGER	R/O	1 = detect 2 = missing
I40statusDataAncEia708708B	I40statusDataTBL.153	INTEGER	R/O	1 = detect 2 = missing
I40statusDataAncEia708708C	I40statusDataTBL.154	INTEGER	R/O	1 = detect 2 = missing
I40statusDataAncEia708708D	I40statusDataTBL.155	INTEGER	R/O	1 = detect 2 = missing
I40statusDataAncEia708608A	I40statusDataTBL.156	INTEGER	R/O	1 = detect 2 = missing
I40statusDataAncEia708608B	I40statusDataTBL.157	INTEGER	R/O	1 = detect 2 = missing
I40statusDataAncEia708608C	I40statusDataTBL.158	INTEGER	R/O	1 = detect

20. NETWORK CONTROL

MIB	OID	SYNTAX	ACCESS	VALUE/RANGE
				2 = missing
I40statusDataAncEia708608D	I40statusDataTBL.159	INTEGER	R/O	1 = detect 2 = missing
I40statusDataAncEia608A	I40statusDataTBL.160	INTEGER	R/O	1 = detect 2 = missing
I40statusDataAncEia608B	I40statusDataTBL.161	INTEGER	R/O	1 = detect 2 = missing
I40statusDataAncEia608C	I40statusDataTBL.162	INTEGER	R/O	1 = detect 2 = missing
I40statusDataAncEia608D	I40statusDataTBL.163	INTEGER	R/O	1 = detect 2 = missing
I40statusDataAncProgramA	I40statusDataTBL.164	INTEGER	R/O	1 = detect 2 = missing
I40statusDataAncProgramB	I40statusDataTBL.165	INTEGER	R/O	1 = detect 2 = missing
I40statusDataAncProgramC	I40statusDataTBL.166	INTEGER	R/O	1 = detect 2 = missing
I40statusDataAncProgramD	I40statusDataTBL.167	INTEGER	R/O	1 = detect 2 = missing
I40statusDataAncBroadcastA	I40statusDataTBL.168	INTEGER	R/O	1 = detect 2 = missing
I40statusDataAncBroadcastB	I40statusDataTBL.169	INTEGER	R/O	1 = detect 2 = missing
I40statusDataAncBroadcastC	I40statusDataTBL.170	INTEGER	R/O	1 = detect 2 = missing
I40statusDataAncBroadcastD	I40statusDataTBL.171	INTEGER	R/O	1 = detect 2 = missing
I40statusDataAncVbiA	I40statusDataTBL.172	INTEGER	R/O	1 = detect 2 = missing
I40statusDataAncVbiB	I40statusDataTBL.173	INTEGER	R/O	1 = detect 2 = missing
I40statusDataAncVbiC	I40statusDataTBL.174	INTEGER	R/O	1 = detect 2 = missing
I40statusDataAncVbiD	I40statusDataTBL.175	INTEGER	R/O	1 = detect 2 = missing
I40statusDataAncAfd1A	I40statusDataTBL.176	INTEGER	R/O	1 = detect 2 = missing
I40statusDataAncAfd1B	I40statusDataTBL.177	INTEGER	R/O	1 = detect 2 = missing
I40statusDataAncAfd1C	I40statusDataTBL.178	INTEGER	R/O	1 = detect 2 = missing
I40statusDataAncAfd1D	I40statusDataTBL.179	INTEGER	R/O	1 = detect 2 = missing
I40statusDataAncAfd2A	I40statusDataTBL.180	INTEGER	R/O	1 = detect 2 = missing
I40statusDataAncAfd2B	I40statusDataTBL.181	INTEGER	R/O	1 = detect 2 = missing
I40statusDataAncAfd2C	I40statusDataTBL.182	INTEGER	R/O	1 = detect 2 = missing
I40statusDataAncAfd2D	I40statusDataTBL.183	INTEGER	R/O	1 = detect 2 = missing
I40statusDataAncJpnCc1A	I40statusDataTBL.184	INTEGER	R/O	1 = detect 2 = missing
I40statusDataAncJpnCc1B	I40statusDataTBL.185	INTEGER	R/O	1 = detect 2 = missing
I40statusDataAncJpnCc1C	I40statusDataTBL.186	INTEGER	R/O	1 = detect 2 = missing

20. NETWORK CONTROL

MIB	OID	SYNTAX	ACCESS	VALUE/RANGE
I40statusDataAncJpnCc1D	I40statusDataTBL.187	INTEGER	R/O	1 = detect 2 = missing
I40statusDataAncJpnCc2A	I40statusDataTBL.188	INTEGER	R/O	1 = detect 2 = missing
I40statusDataAncJpnCc2B	I40statusDataTBL.189	INTEGER	R/O	1 = detect 2 = missing
I40statusDataAncJpnCc2C	I40statusDataTBL.190	INTEGER	R/O	1 = detect 2 = missing
I40statusDataAncJpnCc2D	I40statusDataTBL.191	INTEGER	R/O	1 = detect 2 = missing
I40statusDataAncJpnCc3A	I40statusDataTBL.192	INTEGER	R/O	1 = detect 2 = missing
I40statusDataAncJpnCc3B	I40statusDataTBL.193	INTEGER	R/O	1 = detect 2 = missing
I40statusDataAncJpnCc3C	I40statusDataTBL.194	INTEGER	R/O	1 = detect 2 = missing
I40statusDataAncJpnCc3D	I40statusDataTBL.195	INTEGER	R/O	1 = detect 2 = missing
I40statusDataAncNetq1A	I40statusDataTBL.196	INTEGER	R/O	1 = detect 2 = missing
I40statusDataAncNetq1B	I40statusDataTBL.197	INTEGER	R/O	1 = detect 2 = missing
I40statusDataAncNetq1C	I40statusDataTBL.198	INTEGER	R/O	1 = detect 2 = missing
I40statusDataAncNetq1D	I40statusDataTBL.199	INTEGER	R/O	1 = detect 2 = missing
I40statusDataAncNetq2A	I40statusDataTBL.200	INTEGER	R/O	1 = detect 2 = missing
I40statusDataAncNetq2B	I40statusDataTBL.201	INTEGER	R/O	1 = detect 2 = missing
I40statusDataAncNetq2C	I40statusDataTBL.202	INTEGER	R/O	1 = detect 2 = missing
I40statusDataAncNetq2D	I40statusDataTBL.203	INTEGER	R/O	1 = detect 2 = missing
I40statusDataAncTriggerA	I40statusDataTBL.204	INTEGER	R/O	1 = detect 2 = missing
I40statusDataAncTriggerB	I40statusDataTBL.205	INTEGER	R/O	1 = detect 2 = missing
I40statusDataAncTriggerC	I40statusDataTBL.206	INTEGER	R/O	1 = detect 2 = missing
I40statusDataAncTriggerD	I40statusDataTBL.207	INTEGER	R/O	1 = detect 2 = missing
I40statusDataAncUser1A	I40statusDataTBL.208	INTEGER	R/O	1 = detect 2 = missing
I40statusDataAncUser1B	I40statusDataTBL.209	INTEGER	R/O	1 = detect 2 = missing
I40statusDataAncUser1C	I40statusDataTBL.210	INTEGER	R/O	1 = detect 2 = missing
I40statusDataAncUser1D	I40statusDataTBL.211	INTEGER	R/O	1 = detect 2 = missing
I40statusDataAncUser2A	I40statusDataTBL.212	INTEGER	R/O	1 = detect 2 = missing
I40statusDataAncUser2B	I40statusDataTBL.213	INTEGER	R/O	1 = detect 2 = missing
I40statusDataAncUser2C	I40statusDataTBL.214	INTEGER	R/O	1 = detect 2 = missing
I40statusDataAncUser2D	I40statusDataTBL.215	INTEGER	R/O	1 = detect

20. NETWORK CONTROL

MIB	OID	SYNTAX	ACCESS	VALUE/RANGE
				2 = missing
I40statusDataAncPktPayloadA	I40statusDataTBL.216	DisplayString	R/O	Palyload ID
I40statusDataAncPktPayloadB	I40statusDataTBL.217	DisplayString	R/O	Palyload ID
I40statusDataAncPktPayloadC	I40statusDataTBL.218	DisplayString	R/O	Palyload ID
I40statusDataAncPktPayloadD	I40statusDataTBL.219	DisplayString	R/O	Palyload ID
I40statusDataAncPktAribNetqS tationA	I40statusDataTBL.220	DisplayString	R/O	Station Code
I40statusDataAncPktAribNetqS tationB	I40statusDataTBL.221	DisplayString	R/O	Station Code
I40statusDataAncPktAribNetqS tationC	I40statusDataTBL.222	DisplayString	R/O	Station Code
I40statusDataAncPktAribNetqS tationD	I40statusDataTBL.223	DisplayString	R/O	Station Code
I40statusDataAncPktAribNetqV CurrA	I40statusDataTBL.224	DisplayString	R/O	Video Current
I40statusDataAncPktAribNetqV CurrB	I40statusDataTBL.225	DisplayString	R/O	Video Current
I40statusDataAncPktAribNetqV CurrC	I40statusDataTBL.226	DisplayString	R/O	Video Current
I40statusDataAncPktAribNetqV CurrD	I40statusDataTBL.227	DisplayString	R/O	Video Current
I40statusDataAncPktAribNetqV NextA	I40statusDataTBL.228	DisplayString	R/O	Video Next
I40statusDataAncPktAribNetqV NextB	I40statusDataTBL.229	DisplayString	R/O	Video Next
I40statusDataAncPktAribNetqV NextC	I40statusDataTBL.230	DisplayString	R/O	Video Next
I40statusDataAncPktAribNetqV NextD	I40statusDataTBL.231	DisplayString	R/O	Video Next
I40statusDataAncPktAribNetqA CurrA	I40statusDataTBL.232	DisplayString	R/O	Audio Current
I40statusDataAncPktAribNetqA CurrB	I40statusDataTBL.233	DisplayString	R/O	Audio Current
I40statusDataAncPktAribNetqA CurrC	I40statusDataTBL.234	DisplayString	R/O	Audio Current
I40statusDataAncPktAribNetqA CurrD	I40statusDataTBL.235	DisplayString	R/O	Audio Current
I40statusDataAncPktAribNetqA NextA	I40statusDataTBL.236	DisplayString	R/O	Audio Next
I40statusDataAncPktAribNetqA NextB	I40statusDataTBL.237	DisplayString	R/O	Audio Next
I40statusDataAncPktAribNetqA NextC	I40statusDataTBL.238	DisplayString	R/O	Audio Next
I40statusDataAncPktAribNetqA NextD	I40statusDataTBL.239	DisplayString	R/O	Audio Next
I40statusDataAncPktAribNetqD CurrA	I40statusDataTBL.240	DisplayString	R/O	Downmix Current
I40statusDataAncPktAribNetqD CurrB	I40statusDataTBL.241	DisplayString	R/O	Downmix Current
I40statusDataAncPktAribNetqD CurrC	I40statusDataTBL.242	DisplayString	R/O	Downmix Current
I40statusDataAncPktAribNetqD CurrD	I40statusDataTBL.243	DisplayString	R/O	Downmix Current
I40statusDataAncPktAribNetqD NextA	I40statusDataTBL.244	DisplayString	R/O	Downmix Next
I40statusDataAncPktAribNetqD NextB	I40statusDataTBL.245	DisplayString	R/O	Downmix Next

20. NETWORK CONTROL

MIB	OID	SYNTAX	ACCESS	VALUE/RANGE
I40statusDataAncPktAribNetqD NextC	I40statusDataTBL.246	DisplayString	R/O	Downmix Next
I40statusDataAncPktAribNetqD NextD	I40statusDataTBL.247	DisplayString	R/O	Downmix Next
I40statusDataAncPktSmpteAfd CodeA	I40statusDataTBL.248	DisplayString	R/O	AFD Code
I40statusDataAncPktSmpteAfd CodeB	I40statusDataTBL.249	DisplayString	R/O	AFD Code
I40statusDataAncPktSmpteAfd CodeC	I40statusDataTBL.250	DisplayString	R/O	AFD Code
I40statusDataAncPktSmpteAfd CodeD	I40statusDataTBL.251	DisplayString	R/O	AFD Code
I40statusDataAncPktSmpteAfd FrameA	I40statusDataTBL.252	DisplayString	R/O	Code Frame
I40statusDataAncPktSmpteAfd FrameB	I40statusDataTBL.253	DisplayString	R/O	Code Frame
I40statusDataAncPktSmpteAfd FrameC	I40statusDataTBL.254	DisplayString	R/O	Code Frame
I40statusDataAncPktSmpteAfd FrameD	I40statusDataTBL.255	DisplayString	R/O	Code Frame
I40statusDataAncPktSmpteAfd BarFlgA	I40statusDataTBL.256	DisplayString	R/O	Bar Data Flags
I40statusDataAncPktSmpteAfd BarFlgB	I40statusDataTBL.257	DisplayString	R/O	Bar Data Flags
I40statusDataAncPktSmpteAfd BarFlgC	I40statusDataTBL.258	DisplayString	R/O	Bar Data Flags
I40statusDataAncPktSmpteAfd BarFlgD	I40statusDataTBL.259	DisplayString	R/O	Bar Data Flags
I40statusDataAncPktSmpteAfd BarVal1A	I40statusDataTBL.260	DisplayString	R/O	Bar Data Value1
I40statusDataAncPktSmpteAfd BarVal1B	I40statusDataTBL.261	DisplayString	R/O	Bar Data Value1
I40statusDataAncPktSmpteAfd BarVal1C	I40statusDataTBL.262	DisplayString	R/O	Bar Data Value1
I40statusDataAncPktSmpteAfd BarVal1D	I40statusDataTBL.263	DisplayString	R/O	Bar Data Value1
I40statusDataAncPktSmpteAfd BarVal2A	I40statusDataTBL.264	DisplayString	R/O	Bar Data Value2
I40statusDataAncPktSmpteAfd BarVal2B	I40statusDataTBL.265	DisplayString	R/O	Bar Data Value2
I40statusDataAncPktSmpteAfd BarVal2C	I40statusDataTBL.266	DisplayString	R/O	Bar Data Value2
I40statusDataAncPktSmpteAfd BarVal2D	I40statusDataTBL.267	DisplayString	R/O	Bar Data Value2
I40statusIpTBL	I40statusTBL.13	Aggregate	-	-
I40statusIpJitterPeriod	I40statusIpTBL.4	INTEGER	R/W	1 = 2min 2 = 10min 3 = 30min 4 = 1hour 5 = 2hour 6 = 6hour 7 = 12hour 8 = 24hour 9 = 72hour
I40statusIpJitterClear	I40statusIpTBL.5	INTEGER	WO	1 (fixed)
I40statusIpPtpPeriod	I40statusIpTBL.6	INTEGER	R/W	1 = 2min 2 = 10min

20. NETWORK CONTROL

MIB	OID	SYNTAX	ACCESS	VALUE/RANGE
				3 = 30min 4 = 1hour 5 = 2hour 6 = 6hour 7 = 12hour 8 = 24hour 9 = 72hour
I40statusIpPtpClear	I40statusIpTBL.7	INTEGER	WO	1 (fixed)
I40statusIpPtpMode	I40statusIpTBL.8	INTEGER	R/W	1 = delay 2 = offset 3 = info
I40statusIpPeriod	I40statusIpTBL.9	INTEGER	R/W	1 = 2min 2 = 10min 3 = 30min 4 = 1hour 5 = 2hour 6 = 6hour 7 = 12hour 8 = 24hour 9 = 72hour
I40statusIpClear	I40statusIpTBL.10	INTEGER	WO	1 (fixed)
I40statusIpWdlyPeriod	I40statusIpTBL.12	INTEGER	R/W	1 = 2min 2 = 10min 3 = 30min 4 = 1hour 5 = 2hour 6 = 6hour 7 = 12hour 8 = 24hour 9 = 72hour
I40statusIpWdlyClear	I40statusIpTBL.13	INTEGER	WO	1 (fixed)
I40statusIpPtpScale	I40statusIpTBL.14	DisplayString	R/W	0.5 to 10.5
I40statusIpPtpDiffPeriod	I40statusIpTBL.15	INTEGER	R/W	1 = 2min 2 = 10min 3 = 30min 4 = 1hour 5 = 2hour 6 = 6hour 7 = 12hour 8 = 24hour 9 = 72hour
I40statusIpPtpDiffClear	I40statusIpTBL.16	INTEGER	WO	1 (fixed)
I40statusIpPtpDiffModeVideo	I40statusIpTBL.18	INTEGER	R/W	1 = on 2 = off
I40statusIpPtpDiffModeAudio	I40statusIpTBL.19	INTEGER	R/W	1 = on 2 = off
I40statusIpPtpDiffModeAnc	I40statusIpTBL.20	INTEGER	R/W	1 = on 2 = off
I40statusIpInfoPheaderMode	I40statusIpTBL.22	INTEGER	R/W	1 = mac/ip 2 = udp/rtp 3 = payload
I40statusIpInfoPheaderMeasure	I40statusIpTBL.23	INTEGER	R/W	1 = run 2 = stop
I40statusIpBufferPeriod	I40statusIpTBL.27	INTEGER	R/W	1 = 2min 2 = 10min 3 = 30min 4 = 1hour 5 = 2hour

20. NETWORK CONTROL

MIB	OID	SYNTAX	ACCESS	VALUE/RANGE
				6 = 6hour 7 = 12hour 8 = 24hour 9 = 72hour
I40statusIpBufferClear	I40statusIpTBL.28	INTEGER	WO	1 (fixed)
I40statusIpBufferMode	I40statusIpTBL.29	INTEGER	R/W	1 = cmax 2 = vrx
I40statusIpNmosMode	I40statusIpTBL.31	INTEGER	R/W	1 = connection (IS-05) 2 = registration (IS-05)
I40statusIpStreamSelectInputA	I40statusIpTBL.32	INTEGER	R/W	1 = stream1 2 = stream2 3 = stream3 4 = stream4
I40statusIpStreamSelectInputB	I40statusIpTBL.33	INTEGER	R/W	1 = stream1 2 = stream2 3 = stream3 4 = stream4
I40statusIpStreamSelectInputC	I40statusIpTBL.34	INTEGER	R/W	1 = stream1 2 = stream2 3 = stream3 4 = stream4
I40statusIpStreamSelectInputD	I40statusIpTBL.35	INTEGER	R/W	1 = stream1 2 = stream2 3 = stream3 4 = stream4
I40statusIpJpegXsStatusErrorClear	I40statusIpTBL.36	INTEGER	R/WO	1 (fixed)
I40statusIpJpegXsHeaderMode	I40statusIpTBL.37	INTEGER	R/W	1 = video-support 2 = profile 3 = buffer 4 = metadata 5 = transport 6 = image 7 = color
I40statusIpDataTBL	I40statusTBL.14	Aggregate	-	
I40statusIpDataLinkStatusPort1	I40statusIpDataTBL.1	INTEGER	R/O	1 = linkup 2 = linkdown
I40statusIpDataLinkStatusPort2	I40statusIpDataTBL.2	INTEGER	R/O	1 = linkup 2 = linkdown
I40statusIpDataBitratePort1	I40statusIpDataTBL.3	DisplayString	R/O	Bitrate
I40statusIpDataBitratePort2	I40statusIpDataTBL.4	DisplayString	R/O	Bitrate
I40statusIpDataPacketJitterMaxPort1Stream1	I40statusIpDataTBL.5	DisplayString	R/O	Packet Jitter Max
I40statusIpDataPacketJitterMinPort1Stream1	I40statusIpDataTBL.6	DisplayString	R/O	Packet Jitter Min
I40statusIpDataPacketJitterAvgPort1Stream1	I40statusIpDataTBL.7	DisplayString	R/O	Packet Jitter Avg
I40statusIpDataPacketJitterMaxPort1Stream2	I40statusIpDataTBL.8	DisplayString	R/O	Packet Jitter Max
I40statusIpDataPacketJitterMinPort1Stream2	I40statusIpDataTBL.9	DisplayString	R/O	Packet Jitter Min
I40statusIpDataPacketJitterAvgPort1Stream2	I40statusIpDataTBL.10	DisplayString	R/O	Packet Jitter Avg
I40statusIpDataPacketJitterMaxPort1Stream3	I40statusIpDataTBL.11	DisplayString	R/O	Packet Jitter Max
I40statusIpDataPacketJitterMinPort1Stream3	I40statusIpDataTBL.12	DisplayString	R/O	Packet Jitter Min

20. NETWORK CONTROL

MIB	OID	SYNTAX	ACCESS	VALUE/RANGE
I40statusIpDataPacketJitterAvgPort1Stream3	I40statusIpDataTBL.13	DisplayString	R/O	Packet Jitter Avg
I40statusIpDataPacketJitterMaxPort1Stream4	I40statusIpDataTBL.14	DisplayString	R/O	Packet Jitter Max
I40statusIpDataPacketJitterMinPort1Stream4	I40statusIpDataTBL.15	DisplayString	R/O	Packet Jitter Min
I40statusIpDataPacketJitterAvgPort1Stream4	I40statusIpDataTBL.16	DisplayString	R/O	Packet Jitter Avg
I40statusIpDataPacketJitterMaxPort2Stream1	I40statusIpDataTBL.17	DisplayString	R/O	Packet Jitter Max
I40statusIpDataPacketJitterMinPort2Stream1	I40statusIpDataTBL.18	DisplayString	R/O	Packet Jitter Min
I40statusIpDataPacketJitterAvgPort2Stream1	I40statusIpDataTBL.19	DisplayString	R/O	Packet Jitter Avg
I40statusIpDataPacketJitterMaxPort1Stream2	I40statusIpDataTBL.20	DisplayString	R/O	Packet Jitter Max
I40statusIpDataPacketJitterMinPort1Stream2	I40statusIpDataTBL.21	DisplayString	R/O	Packet Jitter Min
I40statusIpDataPacketJitterAvgPort1Stream2	I40statusIpDataTBL.22	DisplayString	R/O	Packet Jitter Avg
I40statusIpDataPacketJitterMaxPort1Stream3	I40statusIpDataTBL.23	DisplayString	R/O	Packet Jitter Max
I40statusIpDataPacketJitterMinPort1Stream3	I40statusIpDataTBL.24	DisplayString	R/O	Packet Jitter Min
I40statusIpDataPacketJitterAvgPort1Stream3	I40statusIpDataTBL.25	DisplayString	R/O	Packet Jitter Avg
I40statusIpDataPacketJitterMaxPort1Stream4	I40statusIpDataTBL.26	DisplayString	R/O	Packet Jitter Max
I40statusIpDataPacketJitterMinPort1Stream4	I40statusIpDataTBL.27	DisplayString	R/O	Packet Jitter Min
I40statusIpDataPacketJitterAvgPort1Stream4	I40statusIpDataTBL.28	DisplayString	R/O	Packet Jitter Avg
I40statusIpDataStatusFormatStream1	I40statusIpDataTBL.29	DisplayString	R/O	IP Format
I40statusIpDataStatusFormatStream2	I40statusIpDataTBL.30	DisplayString	R/O	IP Format
I40statusIpDataStatusFormatStream3	I40statusIpDataTBL.31	DisplayString	R/O	IP Format
I40statusIpDataStatusFormatStream4	I40statusIpDataTBL.32	DisplayString	R/O	IP Format
I40statusIpDataStatusFrameRateStream1	I40statusIpDataTBL.33	DisplayString	R/O	IP Framrate
I40statusIpDataStatusFrameRateStream2	I40statusIpDataTBL.34	DisplayString	R/O	IP Framrate
I40statusIpDataStatusFrameRateStream3	I40statusIpDataTBL.35	DisplayString	R/O	IP Framrate
I40statusIpDataStatusFrameRateStream4	I40statusIpDataTBL.36	DisplayString	R/O	IP Framrate
I40statusIpDataStatusPacketCountStream1	I40statusIpDataTBL.37	DisplayString	R/O	PacketCount
I40statusIpDataStatusPacketCountStream2	I40statusIpDataTBL.38	DisplayString	R/O	PacketCount
I40statusIpDataStatusPacketCountStream3	I40statusIpDataTBL.39	DisplayString	R/O	PacketCount
I40statusIpDataStatusPacketCountStream4	I40statusIpDataTBL.40	DisplayString	R/O	PacketCount
I40statusIpDataStatusActiveData	I40statusIpDataTBL.41	DisplayString	R/O	IP Active Data

20. NETWORK CONTROL

MIB	OID	SYNTAX	ACCESS	VALUE/RANGE
taStream1				
I40statusIpDataStatusActiveDataStream2	I40statusIpDataTBL.42	DisplayString	R/O	IP Active Data
I40statusIpDataStatusActiveDataStream3	I40statusIpDataTBL.43	DisplayString	R/O	IP Active Data
I40statusIpDataStatusActiveDataStream4	I40statusIpDataTBL.44	DisplayString	R/O	IP Active Data
I40statusIpDataStatusMarkerbitStream1	I40statusIpDataTBL.45	INTEGER	R/O	1 = detect 2 = missing
I40statusIpDataStatusMarkerbitStream2	I40statusIpDataTBL.46	INTEGER	R/O	1 = detect 2 = missing
I40statusIpDataStatusMarkerbitStream3	I40statusIpDataTBL.47	INTEGER	R/O	1 = detect 2 = missing
I40statusIpDataStatusMarkerbitStream4	I40statusIpDataTBL.48	INTEGER	R/O	1 = detect 2 = missing
I40statusIpDataStatusFieldIdentificationStream1	I40statusIpDataTBL.49	DisplayString	R/O	IP Field ID
I40statusIpDataStatusFieldIdentificationStream2	I40statusIpDataTBL.50	DisplayString	R/O	IP Field ID
I40statusIpDataStatusFieldIdentificationStream3	I40statusIpDataTBL.51	DisplayString	R/O	IP Field ID
I40statusIpDataStatusFieldIdentificationStream4	I40statusIpDataTBL.52	DisplayString	R/O	IP Field ID
I40statusIpDataStatusContinuationStream1	I40statusIpDataTBL.53	DisplayString	R/O	Continuation
I40statusIpDataStatusContinuationStream2	I40statusIpDataTBL.54	DisplayString	R/O	Continuation
I40statusIpDataStatusContinuationStream3	I40statusIpDataTBL.55	DisplayString	R/O	Continuation
I40statusIpDataStatusContinuationStream4	I40statusIpDataTBL.56	DisplayString	R/O	Continuation
I40statusIpDataStatusPackingModeStream1	I40statusIpDataTBL.57	DisplayString	R/O	PackingMode
I40statusIpDataStatusPackingModeStream2	I40statusIpDataTBL.58	DisplayString	R/O	PackingMode
I40statusIpDataStatusPackingModeStream3	I40statusIpDataTBL.59	DisplayString	R/O	PackingMode
I40statusIpDataStatusPackingModeStream4	I40statusIpDataTBL.60	DisplayString	R/O	PackingMode
I40statusIpDataPtpStatusPort1	I40statusIpDataTBL.61	INTEGER	R/O	1 = lock 2 = unlock 3 = ready 4 = not detec
I40statusIpDataPtpStatusPort2	I40statusIpDataTBL.62	INTEGER	R/O	1 = lock 2 = unlock 3 = ready 4 = not detec
I40statusIpDataPtpGmIdMaxPort1	I40statusIpDataTBL.63	DisplayString	R/O	PTP GM ID
I40statusIpDataPtpGmIdMaxPort2	I40statusIpDataTBL.64	DisplayString	R/O	PTP GM ID
I40statusIpDataPtpUtcTime	I40statusIpDataTBL.65	DisplayString	R/O	PTP UTC TIME
I40statusIpDataPtpDelayTimeMaxPort1	I40statusIpDataTBL.66	DisplayString	R/O	PTP Delay Time Max
I40statusIpDataPtpDelayTimeMinPort1	I40statusIpDataTBL.67	DisplayString	R/O	PTP Delay Time Min
I40statusIpDataPtpDelayTimeC	I40statusIpDataTBL.68	DisplayString	R/O	PTP Delay Time Current

20. NETWORK CONTROL

MIB	OID	SYNTAX	ACCESS	VALUE/RANGE
urrentPort1				
I40statusIpDataPtpDelayTimeMaxPort2	I40statusIpDataTBL.69	DisplayString	R/O	PTP Delay Time Max
I40statusIpDataPtpDelayTimeMinPort2	I40statusIpDataTBL.70	DisplayString	R/O	PTP Delay Time Min
I40statusIpDataPtpDelayTimeCurrentPort2	I40statusIpDataTBL.71	DisplayString	R/O	PTP Delay Time Current
I40statusIpDataPtpTimeOffsetMaxPort1	I40statusIpDataTBL.72	DisplayString	R/O	PTP Time Offset Max
I40statusIpDataPtpTimeOffsetMinPort1	I40statusIpDataTBL.73	DisplayString	R/O	PTP Time Offset Min
I40statusIpDataPtpTimeOffsetCurrentPort1	I40statusIpDataTBL.74	DisplayString	R/O	PTP Time Offset Current
I40statusIpDataPtpTimeOffsetMaxPort2	I40statusIpDataTBL.75	DisplayString	R/O	PTP Time Offset Max
I40statusIpDataPtpTimeOffsetMinPort2	I40statusIpDataTBL.76	DisplayString	R/O	PTP Time Offset Min
I40statusIpDataPtpTimeOffsetCurrentPort2	I40statusIpDataTBL.77	DisplayString	R/O	PTP Time Offset Current
I40statusIpDataPtpDeltaT2T1Port1	I40statusIpDataTBL.78	DisplayString	R/O	PTP Delat T2-T1
I40statusIpDataPtpDeltaT2T1Port2	I40statusIpDataTBL.79	DisplayString	R/O	PTP Delat T2-T1
I40statusIpDataPtpDeltaT4T3Port1	I40statusIpDataTBL.80	DisplayString	R/O	PTP Delat T4-T3
I40statusIpDataPtpDeltaT4T3Port2	I40statusIpDataTBL.81	DisplayString	R/O	PTP Delat T4-T3
I40statusIpDataPtpSyncMsgCountPort1	I40statusIpDataTBL.82	DisplayString	R/O	PTP Sync Msg Count
I40statusIpDataPtpSyncMsgCountPort2	I40statusIpDataTBL.83	DisplayString	R/O	PTP Sync Msg Count
I40statusIpDataPtpFollowUpMsgCountPort1	I40statusIpDataTBL.84	DisplayString	R/O	PTP Follow up Msg Count
I40statusIpDataPtpFollowUpMsgCountPort2	I40statusIpDataTBL.85	DisplayString	R/O	PTP Follow up Msg Count
I40statusIpDataPtpDelayRequestMsgCountPort1	I40statusIpDataTBL.86	DisplayString	R/O	PTP Delay Req Msg Count
I40statusIpDataPtpDelayRequestMsgCountPort2	I40statusIpDataTBL.87	DisplayString	R/O	PTP Delay Req Msg Count
I40statusIpDataPtpDelayResponseMsgCountPort1	I40statusIpDataTBL.88	DisplayString	R/O	PTP Delay Res Msg Count
I40statusIpDataPtpDelayResponseMsgCountPort2	I40statusIpDataTBL.89	DisplayString	R/O	PTP Delay Res Msg Count
I40statusIpDataPtpAnnounceMsgCountPort1	I40statusIpDataTBL.90	DisplayString	R/O	PTP Announce Msg Count
I40statusIpDataPtpAnnounceMsgCountPort2	I40statusIpDataTBL.91	DisplayString	R/O	PTP Announce Msg Count
I40statusIpDataPtpManagementMsgCountPort1	I40statusIpDataTBL.92	DisplayString	R/O	PTP Manage Msg Count
I40statusIpDataPtpManagementMsgCountPort2	I40statusIpDataTBL.93	DisplayString	R/O	PTP Manage Msg Count
I40statusIpDataPtpDomainNumberPort1	I40statusIpDataTBL.94	DisplayString	R/O	PTP Domain Number
I40statusIpDataPtpDomainNumberPort2	I40statusIpDataTBL.95	DisplayString	R/O	PTP Domain Number
I40statusIpDataPtpOriginTimestampPort1	I40statusIpDataTBL.96	DisplayString	R/O	PTP OrigineTimestamp

20. NETWORK CONTROL

MIB	OID	SYNTAX	ACCESS	VALUE/RANGE
I40statusIpDataPtpOriginTimestampPort2	I40statusIpDataTBL.97	DisplayString	R/O	PTP OrigineTimestamp
I40statusIpDataPtpUtcOffsetPort1	I40statusIpDataTBL.98	DisplayString	R/O	PTP UTC Offset
I40statusIpDataPtpUtcOffsetPort2	I40statusIpDataTBL.99	DisplayString	R/O	PTP UTC Offset
I40statusIpDataPtpPriority1Port1	I40statusIpDataTBL.100	DisplayString	R/O	PTP Priority1
I40statusIpDataPtpPriority1Port2	I40statusIpDataTBL.101	DisplayString	R/O	PTP Priority1
I40statusIpDataPtpClockClassPort1	I40statusIpDataTBL.102	DisplayString	R/O	PTP Clock Class
I40statusIpDataPtpClockClassPort2	I40statusIpDataTBL.103	DisplayString	R/O	PTP Clock Class
I40statusIpDataPtpClockAccuracyPort1	I40statusIpDataTBL.104	DisplayString	R/O	PTPT Clock Accuracy
I40statusIpDataPtpClockAccuracyPort2	I40statusIpDataTBL.105	DisplayString	R/O	PTPT Clock Accuracy
I40statusIpDataPtpClockVariancePort1	I40statusIpDataTBL.106	DisplayString	R/O	PTP Clock Variance
I40statusIpDataPtpClockVariancePort2	I40statusIpDataTBL.107	DisplayString	R/O	PTP Clock Variance
I40statusIpDataPtpPriority2Port1	I40statusIpDataTBL.108	DisplayString	R/O	PTP Priority2
I40statusIpDataPtpPriority2Port2	I40statusIpDataTBL.109	DisplayString	R/O	PTP Priority2
I40statusIpDataPtpStepsRemovedPort1	I40statusIpDataTBL.110	DisplayString	R/O	PTP Steps Removed
I40statusIpDataPtpStepsRemovedPort2	I40statusIpDataTBL.111	DisplayString	R/O	PTP Steps Removed
I40statusIpDataPtpTimeSourcePort1	I40statusIpDataTBL.112	DisplayString	R/O	PTP Time Source
I40statusIpDataPtpTimeSourcePort2	I40statusIpDataTBL.113	DisplayString	R/O	PTP Time Source
I40statusIpDataTimingComparisonVideoMaxPort1Stream1	I40statusIpDataTBL.114	DisplayString	R/O	Timing Comparison Video Max
I40statusIpDataTimingComparisonVideoMinPort1Stream1	I40statusIpDataTBL.115	DisplayString	R/O	Timing Comparison Video Min
I40statusIpDataTimingComparisonVideoAvgPort1Stream1	I40statusIpDataTBL.116	DisplayString	R/O	Timing Comparison Video Avg
I40statusIpDataTimingComparisonVideoMaxPort1Stream2	I40statusIpDataTBL.117	DisplayString	R/O	Timing Comparison Video Max
I40statusIpDataTimingComparisonVideoMinPort1Stream2	I40statusIpDataTBL.118	DisplayString	R/O	Timing Comparison Video Min
I40statusIpDataTimingComparisonVideoAvgPort1Stream2	I40statusIpDataTBL.119	DisplayString	R/O	Timing Comparison Video Avg
I40statusIpDataTimingComparisonVideoMaxPort1Stream3	I40statusIpDataTBL.120	DisplayString	R/O	Timing Comparison Video Max
I40statusIpDataTimingComparisonVideoMinPort1Stream3	I40statusIpDataTBL.121	DisplayString	R/O	Timing Comparison Video Min
I40statusIpDataTimingComparisonVideoAvgPort1Stream3	I40statusIpDataTBL.122	DisplayString	R/O	Timing Comparison Video Avg
I40statusIpDataTimingComparisonVideoMaxPort1Stream4	I40statusIpDataTBL.123	DisplayString	R/O	Timing Comparison Video Max
I40statusIpDataTimingComparisonVideoMinPort1Stream4	I40statusIpDataTBL.124	DisplayString	R/O	Timing Comparison Video Min
I40statusIpDataTimingComparisonVideoAvgPort1Stream4	I40statusIpDataTBL.125	DisplayString	R/O	Timing Comparison

20. NETWORK CONTROL

MIB	OID	SYNTAX	ACCESS	VALUE/RANGE
sonVideoAvgPort1Stream4				Video Avg
I40statusIpDataTimingComparisonVideoMaxPort2Stream1	I40statusIpDataTBL.126	DisplayString	R/O	Timing Comparison Video Max
I40statusIpDataTimingComparisonVideoMinPort2Stream1	I40statusIpDataTBL.127	DisplayString	R/O	Timing Comparison Video Min
I40statusIpDataTimingComparisonVideoAvgPort2Stream1	I40statusIpDataTBL.128	DisplayString	R/O	Timing Comparison Video Avg
I40statusIpDataTimingComparisonVideoMaxPort2Stream2	I40statusIpDataTBL.129	DisplayString	R/O	Timing Comparison Video Max
I40statusIpDataTimingComparisonVideoMinPort2Stream2	I40statusIpDataTBL.130	DisplayString	R/O	Timing Comparison Video Min
I40statusIpDataTimingComparisonVideoAvgPort2Stream2	I40statusIpDataTBL.131	DisplayString	R/O	Timing Comparison Video Avg
I40statusIpDataTimingComparisonVideoMaxPort2Stream3	I40statusIpDataTBL.132	DisplayString	R/O	Timing Comparison Video Max
I40statusIpDataTimingComparisonVideoMinPort2Stream3	I40statusIpDataTBL.133	DisplayString	R/O	Timing Comparison Video Min
I40statusIpDataTimingComparisonVideoAvgPort2Stream3	I40statusIpDataTBL.134	DisplayString	R/O	Timing Comparison Video Avg
I40statusIpDataTimingComparisonVideoMaxPort2Stream4	I40statusIpDataTBL.135	DisplayString	R/O	Timing Comparison Video Max
I40statusIpDataTimingComparisonVideoMinPort2Stream4	I40statusIpDataTBL.136	DisplayString	R/O	Timing Comparison Video Min
I40statusIpDataTimingComparisonVideoAvgPort2Stream4	I40statusIpDataTBL.137	DisplayString	R/O	Timing Comparison Video Avg
I40statusIpDataTimingComparisonAudioMaxPort1Stream1	I40statusIpDataTBL.138	DisplayString	R/O	Timing Comparison Audio Max
I40statusIpDataTimingComparisonAudioMinPort1Stream1	I40statusIpDataTBL.139	DisplayString	R/O	Timing Comparison Audio Min
I40statusIpDataTimingComparisonAudioAvgPort1Stream1	I40statusIpDataTBL.140	DisplayString	R/O	Timing Comparison Audio Avg
I40statusIpDataTimingComparisonAudioMaxPort1Stream2	I40statusIpDataTBL.141	DisplayString	R/O	Timing Comparison Audio Max
I40statusIpDataTimingComparisonAudioMinPort1Stream2	I40statusIpDataTBL.142	DisplayString	R/O	Timing Comparison Audio Min
I40statusIpDataTimingComparisonAudioAvgPort1Stream2	I40statusIpDataTBL.143	DisplayString	R/O	Timing Comparison Audio Avg
I40statusIpDataTimingComparisonAudioMaxPort1Stream3	I40statusIpDataTBL.144	DisplayString	R/O	Timing Comparison Audio Max
I40statusIpDataTimingComparisonAudioMinPort1Stream3	I40statusIpDataTBL.145	DisplayString	R/O	Timing Comparison Audio Min
I40statusIpDataTimingComparisonAudioAvgPort1Stream3	I40statusIpDataTBL.146	DisplayString	R/O	Timing Comparison Audio Avg
I40statusIpDataTimingComparisonAudioMaxPort1Stream4	I40statusIpDataTBL.147	DisplayString	R/O	Timing Comparison Audio Max
I40statusIpDataTimingComparisonAudioMinPort1Stream4	I40statusIpDataTBL.148	DisplayString	R/O	Timing Comparison Audio Min
I40statusIpDataTimingComparisonAudioAvgPort1Stream4	I40statusIpDataTBL.149	DisplayString	R/O	Timing Comparison Audio Avg
I40statusIpDataTimingComparisonAudioMaxPort2Stream1	I40statusIpDataTBL.150	DisplayString	R/O	Timing Comparison Audio Max
I40statusIpDataTimingComparisonAudioMinPort2Stream1	I40statusIpDataTBL.151	DisplayString	R/O	Timing Comparison Audio Min
I40statusIpDataTimingComparisonAudioAvgPort2Stream1	I40statusIpDataTBL.152	DisplayString	R/O	Timing Comparison Audio Avg
I40statusIpDataTimingComparisonAudioMaxPort2Stream2	I40statusIpDataTBL.153	DisplayString	R/O	Timing Comparison Audio Max

20. NETWORK CONTROL

MIB	OID	SYNTAX	ACCESS	VALUE/RANGE
I40statusIpDataTimingComparisonAudioMinPort2Stream2	I40statusIpDataTBL.154	DisplayString	R/O	Timing Comparison Audio Min
I40statusIpDataTimingComparisonAudioAvgPort2Stream2	I40statusIpDataTBL.155	DisplayString	R/O	Timing Comparison Audio Avg
I40statusIpDataTimingComparisonAudioMaxPort2Stream3	I40statusIpDataTBL.156	DisplayString	R/O	Timing Comparison Audio Max
I40statusIpDataTimingComparisonAudioMinPort2Stream3	I40statusIpDataTBL.157	DisplayString	R/O	Timing Comparison Audio Min
I40statusIpDataTimingComparisonAudioAvgPort2Stream3	I40statusIpDataTBL.158	DisplayString	R/O	Timing Comparison Audio Avg
I40statusIpDataTimingComparisonAudioMaxPort2Stream4	I40statusIpDataTBL.159	DisplayString	R/O	Timing Comparison Audio Max
I40statusIpDataTimingComparisonAudioMinPort2Stream4	I40statusIpDataTBL.160	DisplayString	R/O	Timing Comparison Audio Min
I40statusIpDataTimingComparisonAudioAvgPort2Stream4	I40statusIpDataTBL.161	DisplayString	R/O	Timing Comparison Audio Avg
I40statusIpDataTimingComparisonAncMaxPort1Stream1	I40statusIpDataTBL.162	DisplayString	R/O	Timing Comparison Anc Max
I40statusIpDataTimingComparisonAncMinPort1Stream1	I40statusIpDataTBL.163	DisplayString	R/O	Timing Comparison Anc Min
I40statusIpDataTimingComparisonAncAvgPort1Stream1	I40statusIpDataTBL.164	DisplayString	R/O	Timing Comparison Anc Avg
I40statusIpDataTimingComparisonAncMaxPort1Stream2	I40statusIpDataTBL.165	DisplayString	R/O	Timing Comparison Anc Max
I40statusIpDataTimingComparisonAncMinPort1Stream2	I40statusIpDataTBL.166	DisplayString	R/O	Timing Comparison Anc Min
I40statusIpDataTimingComparisonAncAvgPort1Stream2	I40statusIpDataTBL.167	DisplayString	R/O	Timing Comparison Anc Avg
I40statusIpDataTimingComparisonAncMaxPort1Stream3	I40statusIpDataTBL.168	DisplayString	R/O	Timing Comparison Anc Max
I40statusIpDataTimingComparisonAncMinPort1Stream3	I40statusIpDataTBL.169	DisplayString	R/O	Timing Comparison Anc Min
I40statusIpDataTimingComparisonAncAvgPort1Stream3	I40statusIpDataTBL.170	DisplayString	R/O	Timing Comparison Anc Avg
I40statusIpDataTimingComparisonAncMaxPort1Stream4	I40statusIpDataTBL.171	DisplayString	R/O	Timing Comparison Anc Max
I40statusIpDataTimingComparisonAncMinPort1Stream4	I40statusIpDataTBL.172	DisplayString	R/O	Timing Comparison Anc Min
I40statusIpDataTimingComparisonAncAvgPort1Stream4	I40statusIpDataTBL.173	DisplayString	R/O	Timing Comparison Anc Avg
I40statusIpDataTimingComparisonAncMaxPort2Stream1	I40statusIpDataTBL.174	DisplayString	R/O	Timing Comparison Anc Max
I40statusIpDataTimingComparisonAncMinPort2Stream1	I40statusIpDataTBL.175	DisplayString	R/O	Timing Comparison Anc Min
I40statusIpDataTimingComparisonAncAvgPort2Stream1	I40statusIpDataTBL.176	DisplayString	R/O	Timing Comparison Anc Avg
I40statusIpDataTimingComparisonAncMaxPort2Stream2	I40statusIpDataTBL.177	DisplayString	R/O	Timing Comparison Anc Max
I40statusIpDataTimingComparisonAncMinPort2Stream2	I40statusIpDataTBL.178	DisplayString	R/O	Timing Comparison Anc Min
I40statusIpDataTimingComparisonAncAvgPort2Stream2	I40statusIpDataTBL.179	DisplayString	R/O	Timing Comparison Anc Avg
I40statusIpDataTimingComparisonAncMaxPort2Stream3	I40statusIpDataTBL.180	DisplayString	R/O	Timing Comparison Anc Max
I40statusIpDataTimingComparisonAncMinPort2Stream3	I40statusIpDataTBL.181	DisplayString	R/O	Timing Comparison Anc Min
I40statusIpDataTimingComparisonAncMaxPort2Stream4	I40statusIpDataTBL.182	DisplayString	R/O	Timing Comparison Anc

20. NETWORK CONTROL

MIB	OID	SYNTAX	ACCESS	VALUE/RANGE
sonAncAvgPort2Stream3				Avg
I40statusIpDataTimingComparisonAncMaxPort2Stream4	I40statusIpDataTBL.183	DisplayString	R/O	Timing Comparison Anc Max
I40statusIpDataTimingComparisonAncMinPort2Stream4	I40statusIpDataTBL.184	DisplayString	R/O	Timing Comparison Anc Min
I40statusIpDataTimingComparisonAncAvgPort2Stream4	I40statusIpDataTBL.185	DisplayString	R/O	Timing Comparison Anc Avg
I40statusIpDataPathDelayStatusStream1	I40statusIpDataTBL.186	INTEGER	R/O	1 = port1 1st 2 = port2 1st
I40statusIpDataPathDelayStatusStream2	I40statusIpDataTBL.187	INTEGER	R/O	1 = port1 1st 2 = port2 1st
I40statusIpDataPathDelayStatusStream3	I40statusIpDataTBL.188	INTEGER	R/O	1 = port1 1st 2 = port2 1st
I40statusIpDataPathDelayStatusStream4	I40statusIpDataTBL.189	INTEGER	R/O	1 = port1 1st 2 = port2 1st
I40statusIpDataPathDelayMaxStream1	I40statusIpDataTBL.190	DisplayString	R/O	Path Delay Max
I40statusIpDataPathDelayMinStream1	I40statusIpDataTBL.191	DisplayString	R/O	Path Delay Min
I40statusIpDataPathDelayAvgStream1	I40statusIpDataTBL.192	DisplayString	R/O	Path Delay Avg
I40statusIpDataPathDelayMaxStream2	I40statusIpDataTBL.193	DisplayString	R/O	Path Delay Max
I40statusIpDataPathDelayMinStream2	I40statusIpDataTBL.194	DisplayString	R/O	Path Delay Min
I40statusIpDataPathDelayAvgStream2	I40statusIpDataTBL.195	DisplayString	R/O	Path Delay Avg
I40statusIpDataPathDelayMaxStream3	I40statusIpDataTBL.196	DisplayString	R/O	Path Delay Max
I40statusIpDataPathDelayMinStream3	I40statusIpDataTBL.197	DisplayString	R/O	Path Delay Min
I40statusIpDataPathDelayAvgStream3	I40statusIpDataTBL.198	DisplayString	R/O	Path Delay Avg
I40statusIpDataPathDelayMaxStream4	I40statusIpDataTBL.199	DisplayString	R/O	Path Delay Max
I40statusIpDataPathDelayMinStream4	I40statusIpDataTBL.200	DisplayString	R/O	Path Delay Min
I40statusIpDataPathDelayAvgStream4	I40statusIpDataTBL.201	DisplayString	R/O	Path Delay Avg
I40statusIpDataPacketBufferCmaxPort1Stream1	I40statusIpDataTBL.202	DisplayString	R/O	Packet Buffer CMAX
I40statusIpDataPacketBufferCmaxPort1Stream2	I40statusIpDataTBL.203	DisplayString	R/O	Packet Buffer CMAX
I40statusIpDataPacketBufferCmaxPort1Stream3	I40statusIpDataTBL.204	DisplayString	R/O	Packet Buffer CMAX
I40statusIpDataPacketBufferCmaxPort1Stream4	I40statusIpDataTBL.205	DisplayString	R/O	Packet Buffer CMAX
I40statusIpDataPacketBufferVrxPort1Stream1	I40statusIpDataTBL.206	DisplayString	R/O	Packet Buffer VRX
I40statusIpDataPacketBufferVrxPort1Stream2	I40statusIpDataTBL.207	DisplayString	R/O	Packet Buffer VRX
I40statusIpDataPacketBufferVrxPort1Stream3	I40statusIpDataTBL.208	DisplayString	R/O	Packet Buffer VRX
I40statusIpDataPacketBufferVrxPort1Stream4	I40statusIpDataTBL.209	DisplayString	R/O	Packet Buffer VRX
I40statusIpDataPacketBufferCmaxPort2Stream1	I40statusIpDataTBL.210	DisplayString	R/O	Packet Buffer CMAX

20. NETWORK CONTROL

MIB	OID	SYNTAX	ACCESS	VALUE/RANGE
I40statusIpDataPacketBufferC maxPort2Stream2	I40statusIpDataTBL.211	DisplayString	R/O	Packet Buffer CMAX
I40statusIpDataPacketBufferC maxPort2Stream3	I40statusIpDataTBL.212	DisplayString	R/O	Packet Buffer CMAX
I40statusIpDataPacketBufferC maxPort2Stream4	I40statusIpDataTBL.213	DisplayString	R/O	Packet Buffer CMAX
I40statusIpDataPacketBufferVr xPort2Stream1	I40statusIpDataTBL.214	DisplayString	R/O	Packet Buffer VRX
I40statusIpDataPacketBufferVr xPort2Stream2	I40statusIpDataTBL.215	DisplayString	R/O	Packet Buffer VRX
I40statusIpDataPacketBufferVr xPort2Stream3	I40statusIpDataTBL.216	DisplayString	R/O	Packet Buffer VRX
I40statusIpDataPacketBufferVr xPort2Stream4	I40statusIpDataTBL.217	DisplayString	R/O	Packet Buffer VRX
I40statusIpData2110PidStream 1	I40statusIpDataTBL.218	DisplayString	R/O	ST2110-40 Payload ID
I40statusIpData2110PidStream 2	I40statusIpDataTBL.219	DisplayString	R/O	ST2110-40 Payload ID
I40statusIpData2110PidStream 3	I40statusIpDataTBL.220	DisplayString	R/O	ST2110-40 Payload ID
I40statusIpData2110PidStream 4	I40statusIpDataTBL.221	DisplayString	R/O	ST2110-40 Payload ID

- I40eyeTBL(7) group

MIB	OID	SYNTAX	ACCESS	VALUE/RANGE
I40eyeConfigTBL	I40eyeTBL.1	Aggregate	-	-
I40eyeMode	I40eyeConfigTBL.1	INTEGER	R/W	1 = eye 2 = jit
I40eyeInten	I40eyeConfigTBL.2	INTEGER	R/W	-128 to 127
I40eyeScaleInten	I40eyeConfigTBL.3	INTEGER	R/W	-8 to 7
I40eyeColor	I40eyeConfigTBL.4	INTEGER	R/W	1 = white 2 = yellow 3 = cyan 4 = green 5 = magenta 6 = red 7 = blue
I40eyeScaleColor	I40eyeConfigTBL.5	INTEGER	R/W	1 = white 2 = yellow 3 = cyan 4 = green 5 = magenta 6 = red 7 = blue
I40eyeJitInten	I40eyeConfigTBL.6	INTEGER	R/W	-128 to 127
I40eyeJitScaleInten	I40eyeConfigTBL.7	INTEGER	R/W	-8 to 7
I40eyeJitColor	I40eyeConfigTBL.8	INTEGER	R/W	1 = white 2 = yellow 3 = cyan 4 = green 5 = magenta 6 = red 7 = blue
I40eyeJitScaleColor	I40eyeConfigTBL.9	INTEGER	R/W	1 = white 2 = yellow 3 = cyan 4 = green

20. NETWORK CONTROL

MIB	OID	SYNTAX	ACCESS	VALUE/RANGE
				5 = magenta 6 = red 7 = blue
I40eyeGainTBL	I40eyeTBL.2	Aggregate	-	-
I40eyeGainMode	I40eyeGainTBL.1	INTEGER	R/W	1 = cal 2 = variable
I40eyeGainVar	I40eyeGainTBL.2	DisplayString	R/W	0.50 to 2.00
I40eyeFilter	I40eyeGainTBL.3	INTEGER	R/W	1 = filter-100khz 2 = filter-10khz 3 = filter-1khz 4 = filter-100hz 5 = filter-10hz 6 = filter-timing 7 = filter-alignment
I40eyeSweep	I40eyeGainTBL.4	INTEGER	R/W	1 = sweep-2ui 2 = sweep-4ui 3 = sweep-16ui
I40eyeJitGainMag	I40eyeGainTBL.5	INTEGER	R/W	1 = x1 2 = x2 3 = x8
I40eyeJitGainMag12g	I40eyeGainTBL.6	INTEGER	R/W	1 = x1 2 = x2 3 = x4 4 = x16
I40eyeJitFilter	I40eyeGainTBL.7	INTEGER	R/W	1 = filter-100khz 2 = filter-10khz 3 = filter-1khz 4 = filter-100hz 5 = filter-10hz 6 = filter-timing 7 = filter-alignment
I40eyeJitSweep	I40eyeGainTBL.8	INTEGER	R/W	1 = sweep-1h 2 = sweep-2h 3 = sweep-1v 4 = sweep-2v
I40eyePeakHoldTBL	I40eyeTBL.3	Aggregate	-	-
I40eyePeakHoldMode	I40eyePeakHoldTBL.1	INTEGER	R/W	1 = off 2 = on
I40eyePeakHoldClear	I40eyePeakHoldTBL.2	INTEGER	R/WO	1 (fixed)
I40eyeTrigger	I40eyePeakHoldTBL.3	INTEGER	R/W	1 = run 2 = stop
I40eyeDisplayMode	I40eyePeakHoldTBL.4	INTEGER	R/W	1 = single 2 = dual
I40eyeJitDisplayMode	I40eyePeakHoldTBL.5	INTEGER	R/W	1 = single 2 = dual
I40eyeDataTBL	I40eyeTBL.4	Aggregate	-	-
I40eyeDataAmp	I40eyeDataTBL.1	DisplayString	R/O	Amp
I40eyeDataTr	I40eyeDataTBL.2	DisplayString	R/O	Tr
I40eyeDataTf	I40eyeDataTBL.3	DisplayString	R/O	Tf
I40eyeDataTj	I40eyeDataTBL.4	DisplayString	R/O	Tj
I40eyeDataJ	I40eyeDataTBL.5	DisplayString	R/O	Jitter
I40eyeDataOr	I40eyeDataTBL.6	DisplayString	R/O	Or
I40eyeDataOf	I40eyeDataTBL.7	DisplayString	R/O	Of
I40eyeDataPeakTj	I40eyeDataTBL.8	DisplayString	R/O	Peak Tj
I40eyeDataPeakJit	I40eyeDataTBL.9	DisplayString	R/O	Peak Jitter
I40eyeHistogramTBL	I40eyeTBL.5	Aggregate	-	-
I40eyeHistogramMode	I40eyeHistogramTBL.1	INTEGER	R/W	1 = off

20. NETWORK CONTROL

MIB	OID	SYNTAX	ACCESS	VALUE/RANGE
				2 = on
I40eyeHistogramInten	I40eyeHistogramTBL.2	INTEGER	R/W	-8 to 7
I40eyeHistogramColor	I40eyeHistogramTBL.3	INTEGER	R/W	1 = white 2 = yellow 3 = cyan 4 = green 5 = magenta 6 = red 7 = blue

20. NETWORK CONTROL

• I40audioTBL(8) group

MIB	OID	SYNTAX	ACCESS	VALUE/RANGE
I40audioDispMode	I40audioTBL.1	INTEGER	R/W	1 = lissajou 2 = surround 3 = meter 4 = status 5 = loudness
I40audioMeterTBL	I40audioTBL.2	Aggregate	-	-
I40audioMeterRange	I40audioMeterTBL.1	INTEGER	R/W	1 = range-60dBFS 2 = range-90dBFS 3 = mag
I40audioMeterResponse	I40audioMeterTBL.2	INTEGER	R/W	1 = truepeak 2 = ppm 3 = vu
I40audioMeterPpmMode	I40audioMeterTBL.3	INTEGER	R/W	1 = mode1 2 = mode2
I40audioMeterPeakMeter	I40audioMeterTBL.4	INTEGER	R/W	1 = true 2 = ppm1 3 = ppm2
I40audioMeterPeakHold	I40audioMeterTBL.5	INTEGER	R/W	0 = hold-0 5 = hold-500ms 10 = hold-1000ms 15 = hold-1500ms 20 = hold-2000ms 25 = hold-2500ms 30 = hold-3000ms 35 = hold-3500ms 40 = hold-4000ms 45 = hold-4500ms 50 = hold-5000ms 55 = hold
I40audioMeterOverLevel	I40audioMeterTBL.6	DisplayString	R/W	-40.0 to 0
I40audioMeterWarningLevel	I40audioMeterTBL.7	DisplayString	R/W	-40.0 to 0
I40audioMeterRefLevel	I40audioMeterTBL.8	DisplayString	R/W	-40.0 to 0
I40audioMeterLevelValueDisplay	I40audioMeterTBL.9	INTEGER	R/W	1 = instantly 2 = peakhold
I40audioMeterPeakHoldReset	I40audioMeterTBL.10	INTEGER	R/WO	1 (fixed)
I40audioLissajouTBL	I40audioTBL.3	Aggregate	-	-
I40audioLissajouInten	I40audioLissajouTBL.1	INTEGER	R/W	-8 to 7
I40audioLissajouScaleInten	I40audioLissajouTBL.2	INTEGER	R/W	-8 to 7
I40audioLissajouDisplay	I40audioLissajouTBL.3	INTEGER	R/W	1 = multi 2 = single
I40audioLissajouForm	I40audioLissajouTBL.4	INTEGER	R/W	1 = xy 2 = matrix
I40audioLissajouAutoGain	I40audioLissajouTBL.5	INTEGER	R/W	1 = off 2 = on
I40audioSurroundTBL	I40audioTBL.4	Aggregate	-	-
I40audioSurroundInten	I40audioSurroundTBL.1	INTEGER	R/W	-8 to 7
I40audioSurroundScaleInten	I40audioSurroundTBL.2	INTEGER	R/W	-8 to 7
I40audioSurroundMode	I40audioSurroundTBL.3	INTEGER	R/W	1 = normal 2 = phantom
I40audioSurroundAutoGain	I40audioSurroundTBL.4	INTEGER	R/W	1 = off 2 = on
I40audioStatusTBL	I40audioTBL.5	Aggregate	-	-
I40audioStatusLog	I40audioStatusTBL.1	INTEGER	R/WO	1 (fixed)
I40audioStatusLogging	I40audioStatusTBL.2	INTEGER	R/W	1 = stop 2 = start

20. NETWORK CONTROL

MIB	OID	SYNTAX	ACCESS	VALUE/RANGE
I40audioStatusLogClear	I40audioStatusTBL.3	INTEGER	R/WO	1 (fixed)
I40audioStatusLogMode	I40audioStatusTBL.4	INTEGER	R/W	1 = overwrt 2 = stop
I40audioStatusDisplayChStatus	I40audioStatusTBL.5	INTEGER	R/WO	1 (fixed)
I40audioStatusChStatus	I40audioStatusTBL.6	INTEGER	R/W	1 = ch1 2 = ch2 3 = ch3 4 = ch4 5 = ch5 6 = ch6 7 = ch7 8 = ch8 9 = ch9 10 = ch10 11 = ch11 12 = ch12 13 = ch13 14 = ch14 15 = ch15 16 = ch16 101 = A1 (A:CH1) 102 = A2 (A:CH2) 103 = A3 (A:CH3) 104 = A4 (A:CH4) 105 = A5 (A:CH5) 106 = A6 (A:CH6) 107 = A7 (A:CH7) 108 = A8 (A:CH8) 109 = A9 110 = A10 111 = A11 112 = A12 113 = A13 114 = A14 115 = A15 116 = A16 201 = B1 (B:CH1) 202 = B2 (B:CH2) 203 = B3 (B:CH3) 204 = B4 (B:CH4) 205 = B5 (B:CH5) 206 = B6 (B:CH6) 207 = B7 (B:CH7) 208 = B8 (B:CH8) 209 = B9 210 = B10 211 = B11 212 = B12 213 = B13 214 = B14 215 = B15 216 = B16 301 = C1 302 = C2 303 = C3 304 = C4 305 = C5 306 = C6

20. NETWORK CONTROL

MIB	OID	SYNTAX	ACCESS	VALUE/RANGE
				307 = C7 308 = C8 309 = C9 310 = C10 311 = C11 312 = C12 313 = C13 314 = C14 315 = C15 316 = C16 401 = D1 402 = D2 403 = D3 404 = D4 405 = D5 406 = D6 407 = D7 408 = D8 409 = D9 410 = D10 411 = D11 412 = D12 413 = D13 414 = D14 415 = D15 416 = D16
I40audioStatusChStatusAlign	I40audioStatusTBL.7	INTEGER	R/W	1 = lsb 2 = msb
I40audioStatusDisplayUserBit	I40audioStatusTBL.8	INTEGER	R/WO	1 (fixed)
I40audioStatusUserBit	I40audioConfigTBL.9	INTEGER	R/W	1 = ch1 2 = ch2 3 = ch3 4 = ch4 5 = ch5 6 = ch6 7 = ch7 8 = ch8 9 = ch9 10 = ch10 11 = ch11 12 = ch12 13 = ch13 14 = ch14 15 = ch15 16 = ch16 101 = A1 (A:CH1) 102 = A2 (A:CH2) 103 = A3 (A:CH3) 104 = A4 (A:CH4) 105 = A5 (A:CH5) 106 = A6 (A:CH6) 107 = A7 (A:CH7) 108 = A8 (A:CH8) 109 = A9 110 = A10 111 = A11 112 = A12 113 = A13

20. NETWORK CONTROL

MIB	OID	SYNTAX	ACCESS	VALUE/RANGE
				114 = A14 115 = A15 116 = A16 201 = B1 (B:CH1) 202 = B2 (B:CH2) 203 = B3 (B:CH3) 204 = B4 (B:CH4) 205 = B5 (B:CH5) 206 = B6 (B:CH6) 207 = B7 (B:CH7) 208 = B8 (B:CH8) 209 = B9 210 = B10 211 = B11 212 = B12 213 = B13 214 = B14 215 = B15 216 = B16 301 = C1 302 = C2 303 = C3 304 = C4 305 = C5 306 = C6 307 = C7 308 = C8 309 = C9 310 = C10 311 = C11 312 = C12 313 = C13 314 = C14 315 = C15 316 = C16 401 = D1 402 = D2 403 = D3 404 = D4 405 = D5 406 = D6 407 = D7 408 = D8 409 = D9 410 = D10 411 = D11 412 = D12 413 = D13 414 = D14 415 = D15 416 = D16
I40audioStatusUserBitAlign	I40audioStatusTBL.10	INTEGER	R/W	1 = lsb 2 = msb
I40audioStatusErrorReset	I40audioStatusTBL.11	INTEGER	R/WO	1 (fixed)
I40audioPhonesVolume	I40audioTBL.6	INTEGER	R/W	0 to 63
I40audioDataTBL	I40audioTBL.7	Aggregate	-	-
I40audioDataStatusLevelCh1	I40audioDataTBL.1	DisplayString	R/O	Ch1 Level
I40audioDataStatusLevelCh2	I40audioDataTBL.2	DisplayString	R/O	Ch2 Level

20. NETWORK CONTROL

MIB	OID	SYNTAX	ACCESS	VALUE/RANGE
I40audioDataStatusLevelCh3	I40audioDataTBL.3	DisplayString	R/O	Ch3 Level
I40audioDataStatusLevelCh4	I40audioDataTBL.4	DisplayString	R/O	Ch4 Level
I40audioDataStatusLevelCh5	I40audioDataTBL.5	DisplayString	R/O	Ch5 Level
I40audioDataStatusLevelCh6	I40audioDataTBL.6	DisplayString	R/O	Ch6 Level
I40audioDataStatusLevelCh7	I40audioDataTBL.7	DisplayString	R/O	Ch7 Level
I40audioDataStatusLevelCh8	I40audioDataTBL.8	DisplayString	R/O	Ch8 Level
I40audioDataStatusLevelCh9	I40audioDataTBL.9	DisplayString	R/O	Ch9 Level
I40audioDataStatusLevelCh10	I40audioDataTBL.10	DisplayString	R/O	Ch10 Level
I40audioDataStatusLevelCh11	I40audioDataTBL.11	DisplayString	R/O	Ch11 Level
I40audioDataStatusLevelCh12	I40audioDataTBL.12	DisplayString	R/O	Ch12 Level
I40audioDataStatusLevelCh13	I40audioDataTBL.13	DisplayString	R/O	Ch13 Level
I40audioDataStatusLevelCh14	I40audioDataTBL.14	DisplayString	R/O	Ch14 Level
I40audioDataStatusLevelCh15	I40audioDataTBL.15	DisplayString	R/O	Ch15 Level
I40audioDataStatusLevelCh16	I40audioDataTBL.16	DisplayString	R/O	Ch16 Level
I40audioLoudnessTBL	I40audioTBL.8	Aggregate	-	-
I40audioLoudnessPeriod	I40audioLoudnessTBL.1	INTEGER	R/W	1 = period-2min 2 = period-10min 3 = period-30min 4 = period-1hour 5 = period-2hour 6 = period-6hour 7 = period-12hour 8 = period-24hour
I40audioLoudnessChartClear	I40audioLoudnessTBL.2	INTEGER	R/WO	1 (fixed)
I40audioLoudnessMeasure	I40audioLoudnessTBL.3	INTEGER	R/W	1 = stop 2 = start
I40audioLoudnessMag	I40audioLoudnessTBL.4	INTEGER	R/W	1 = off 2 = on
I40audioDolbyTBL	I40audioTBL.9	Aggregate	-	
I40audioDolbyMetaProgram	I40audioDolbyTBL.1	INTEGER	R/W	1 = prm1 2 = prm2 3 = prm3 4 = prm4 5 = prm5 6 = prm6 7 = prm7 8 = prm8
I40audioDolbyDpMetaSubstream	I40audioDolbyTBL.2	INTEGER	R/W	1 = sub0 2 = sub1 3 = sub2 4 = sub3 5 = sub4 6 = sub5 7 = sub6 8 = sub7

20. NETWORK CONTROL

• I40trapTBL(9) group

MIB	OID	SYNTAX	ACCESS	VALUE/RANGE
I40trapIpTBL	I40trapTBL.1	Aggregate	-	-
I40trapIp1TBL	I40trapIpTBL.1	Aggregate	-	-
I40trapManagerIp1	I40trapIp1TBL.1	IpAddress	R/W	IP Address
I40trapManagerIp1Act	I40trapIp1TBL.2	INTEGER	R/W	1 = enable 2 = disable
I40trapIp2TBL	I40trapIpTBL.2	Aggregate	-	-
I40trapManagerIp2	I40trapIp2TBL.1	IpAddress	R/W	IP Address
I40trapManagerIp2Act	I40trapIp2TBL.2	INTEGER	R/W	1 = enable 2 = disable
I40trapIp3TBL	I40trapIpTBL.3	Aggregate	-	-
I40trapManagerIp3	I40trapIp3TBL.1	IpAddress	R/W	IP Address
I40trapManagerIp3Act	I40trapIp3TBL.2	INTEGER	R/W	1 = enable 2 = disable
I40trapIp4TBL	I40trapIpTBL.4	Aggregate	-	-
I40trapManagerIp4	I40trapIp4TBL.1	IpAddress	R/W	IP Address
I40trapManagerIp4Act	I40trapIp4TBL.2	INTEGER	R/W	1 = enable 2 = disable

20.5.5 Extended TRAP (Variable Binding List)

- index 1
 - OID: iso(1).org(3).dod(6).internet(1).mgmt(2).mib-2(1).system(1).sysUpTime(3).0
 - Syntax: TimeTicks
 - Range: 1 to 4294967295 (overflow occurs if this range is exceeded)
 - Description: Elapsed time after starting the agent
- index 2
 - OID: iso(1).org(3).dod(6).internet(1).snmpV2(6).snmpModules(3).snmpMIB(1).snmpMIBObjects(1).snmpTrap(4).snmpTrapOID(1).0
 - Syntax: OBJECT IDENTIFIER
 - Range: ---
 - Description: Trap OID
- index 3
 - OID: leader(20111).lv5600(40).lv5600ST1(1).l40notificationTBL(0).l40trapStrTBL(2).l40trapCounter(1)
 - Syntax: Counter32
 - Range: 1 to 4294967295
 - Description: The total number of enterprise traps sent after starting up
- index 4
 - OID: leader(20111).lv5600(40).lv5600ST1(1).l40notificationTBL(0).l40trapStrTBL(2).l40trapInternalTimestamp(2)
 - Syntax: DisplayString
 - Range: Up to 20 characters
 - Description: Date and time of error occurrence
- index 5
 - OID: leader(20111).lv5600(40).lv5600ST1(1).l40notificationTBL(0).l40trapStrTBL(2).l40trapInputCh(3)
 - Syntax: INTEGER
 - Range: a(1), b(2), c(3), d(4)
 - Description: Input channel where the error occurred (A/B/C/D)
- index 6
 - OID: leader(20111).lv5600(40).lv5600ST1(1).l40notificationTBL(0).l40trapStrTBL(2).l40trapInputSignal(4)
 - Syntax: DisplayString
 - Range: Up to 20 characters
 - Description: Format information

20. NETWORK CONTROL

- index 7

OID: leader(20111).lv5600(40).lv5600ST1(1).I40notificationTBL(0).
I40trapContentTBL(1).I40trapErrorTBL(1).X

or

leader(20111).lv5600(40).lv5600ST1(1).I40notificationTBL(0).
I40trapContentTBL(1).I40trapNormalTBL(2).X

Syntax: DisplayString

Range: Up to 16 characters

Description: OID indicating the error and error information character string (see the table below)

When an error occurs, OID and error information character string of I40notificationTBL(0).I40trapContentTBL(1).I40trapErrorTBL(1).X (see the table below)

When an error recovers, OID and error information character string of I40notificationTBL(0).I40trapContentTBL(1). I40trapNormalTBL(2).X (see the table below)

- index 8

OID: leader(20111).lv5600(40).lv5600ST1(1).I40notificationTBL(0).
I40trapStrTBL(2).I40trapCableLen(5)

Syntax: INTEGER

Range: 1 to 32767

Description: Cable length

Output only when index7 is I40trapContentTBL(1).I40TrapErrorTBL(1).
I40trapErrorCableWarn(5).

20. NETWORK CONTROL

• I40notificationTBL(0) group

MIB	OID	SYNTAX	ACCESS	VALUE/RANGE
I40trapContentTBL	I40notificationTBL.1		-	-
I40trapErrorTBL	I40trapContentTBL.1	Aggregate	-	-
I40trapErrorFan	I40TrapErrorTBL.1	-	-	FAN_STOP
I40trapErrorNoSignal	I40TrapErrorTBL.2	-	-	NO_SIGNAL
I40trapErrorUnknown	I40TrapErrorTBL.3	-	-	FORMAT_UNKNOWN
I40trapErrorNTP	I40TrapErrorTBL.5	-	-	NTP_ERROR
I40trapErrorIpLinkDown	I40TrapErrorTBL.6	-	-	LINK_DOWN
I40trapErrorSdiCrc	I40TrapErrorTBL.20	-	-	CRC
I40trapErrorSdiEdh	I40TrapErrorTBL.21	-	-	EDH
I40trapErrorSdiTrsPosition	I40TrapErrorTBL.22	-	-	TRS_POSITION
I40trapErrorSdiTrsCode	I40TrapErrorTBL.23	-	-	TRS_CODE
I40trapErrorSdiIllegalCode	I40TrapErrorTBL.24	-	-	ILLEGAL_CODE
I40trapErrorSdiLineNumber	I40TrapErrorTBL.25	-	-	LINE_NUMBER
I40trapErrorCableError	I40TrapErrorTBL.26	-	-	CABLE_ERROR
I40trapErrorCableWarning	I40TrapErrorTBL.27	-	-	CABLE_WARNING
I40trapErrorSdiAncChecksum	I40TrapErrorTBL.28	-	-	CHECK_SUM
I40trapErrorSdiAncParity	I40TrapErrorTBL.29	-	-	PARITY
I40trapErrorSdiGamut	I40TrapErrorTBL.30	-	-	GAMUT
I40trapErrorSdiGamutSt2	I40TrapErrorTBL.31	-	-	GAMUT_ST2
I40trapErrorSdiCompGamut	I40TrapErrorTBL.32	-	-	CMP_GAMUT
I40trapErrorSdiCompGamutSt2	I40TrapErrorTBL.33	-	-	CMP_GAMUT_ST2
I40trapErrorSdiFreeze	I40TrapErrorTBL.34	-	-	FREEZE
I40trapErrorSdiFreezeSt2	I40TrapErrorTBL.35	-	-	FREEZE_ST2
I40trapErrorSdiBlack	I40TrapErrorTBL.36	-	-	BLACK
I40trapErrorSdiBlackSt2	I40TrapErrorTBL.37	-	-	BLACK_ST2
I40trapErrorSdiLevelY	I40TrapErrorTBL.38	-	-	LEVEL_Y
I40trapErrorSdiLevelYSt2	I40TrapErrorTBL.39	-	-	LEVEL_Y_ST2
I40trapErrorSdiLevelC	I40TrapErrorTBL.40	-	-	LEVEL_C
I40trapErrorSdiLevelCSt2	I40TrapErrorTBL.41	-	-	LEVEL_C_ST2
I40trapErrorSdiAudioBch	I40TrapErrorTBL.42	-	-	AUDIO_BCH
I40trapErrorSdiAudioParity	I40TrapErrorTBL.43	-	-	AUDIO_PARITY
I40trapErrorSdiAudioDbn	I40TrapErrorTBL.44	-	-	AUDIO_DBN
I40trapErrorSdiAudioInhibit	I40TrapErrorTBL.45	-	-	AUDIO_INHIBIT
I40trapErrorSdiAudioSample	I40TrapErrorTBL.46	-	-	AUDIO_SAMPLE
I40trapErrorSdiFrequency	I40TrapErrorTBL.47	-	-	FREQUENCY
I40trapErrorSdiFormatAlarm	I40TrapErrorTBL.48	-	-	FORMAT_ALARM
I40trapErrorEye12GCurrentJitter	I40TrapErrorTBL.60	-	-	EYE_12G_JITTER
I40trapErrorEye6GCurrentJitter	I40TrapErrorTBL.61	-	-	EYE_6G_JITTER
I40trapErrorEye3GCurrentJitter	I40TrapErrorTBL.62	-	-	EYE_3G_JITTER
I40trapErrorEyeHdCurrentJitter	I40TrapErrorTBL.63	-	-	EYE_HD_JITTER
I40trapErrorEyeSdCurrentJitter	I40TrapErrorTBL.64	-	-	EYE_SD_JITTER
I40trapErrorEye12GTimingJitter	I40TrapErrorTBL.65	-	-	EYE_12G_T_JITTER
I40trapErrorEye6GTimingJitter	I40TrapErrorTBL.66	-	-	EYE_6G_T_JITTER
I40trapErrorEye3GTimingJitter	I40TrapErrorTBL.67	-	-	EYE_3G_T_JITTER
I40trapErrorEyeHdTimingJitter	I40TrapErrorTBL.68	-	-	EYE_HD_T_JITTER
I40trapErrorEyeSdTimingJitter	I40TrapErrorTBL.69	-	-	EYE_SD_T_JITTER
I40trapErrorEye12GDeltaTimeTrTf	I40TrapErrorTBL.70	-	-	EYE_12G_TR_TF
I40trapErrorEye6GDeltaTimeTrTf	I40TrapErrorTBL.71	-	-	EYE_6G_TR_TF
I40trapErrorEye3GDeltaTimeTrTf	I40TrapErrorTBL.72	-	-	EYE_3G_TR_TF
I40trapErrorEyeHdDeltaTimeTrTf	I40TrapErrorTBL.73	-	-	EYE_HD_TR_TF

20. NETWORK CONTROL

MIB	OID	SYNTAX	ACCESS	VALUE/RANGE
Tf				
I40trapErrorEyeSdDeltaTimeTr Tf	I40TrapErrorTBL.74	-	-	EYE_SD_TR_TF
I40trapErrorEye12GFalltime	I40TrapErrorTBL.75	-	-	EYE_12G_TF
I40trapErrorEye6GFalltime	I40TrapErrorTBL.76	-	-	EYE_6G_TF
I40trapErrorEye3GFalltime	I40TrapErrorTBL.77	-	-	EYE_3G_TF
I40trapErrorEyeHdFalltime	I40TrapErrorTBL.78	-	-	EYE_HD_TF
I40trapErrorEyeSdFalltime	I40TrapErrorTBL.79	-	-	EYE_SD_TF
I40trapErrorEye12GRisetime	I40TrapErrorTBL.80	-	-	EYE_12G_TR
I40trapErrorEye6GRisetime	I40TrapErrorTBL.81	-	-	EYE_6G_TR
I40trapErrorEye3GRisetime	I40TrapErrorTBL.82	-	-	EYE_3G_TR
I40trapErrorEyeHdRisetime	I40TrapErrorTBL.83	-	-	EYE_HD_TR
I40trapErrorEyeSdRisetime	I40TrapErrorTBL.84	-	-	EYE_SD_TR
I40trapErrorEye12GAmp	I40TrapErrorTBL.85	-	-	EYE_12G_AMP
I40trapErrorEye6GAmp	I40TrapErrorTBL.86	-	-	EYE_6G_AMP
I40trapErrorEye3GAmp	I40TrapErrorTBL.87	-	-	EYE_3G_AMP
I40trapErrorEyeHdAmp	I40TrapErrorTBL.88	-	-	EYE_HD_AMP
I40trapErrorEyeSdAmp	I40TrapErrorTBL.89	-	-	EYE_SD_AMP
I40trapErrorEye12GOverShoot Rising	I40TrapErrorTBL.90	-	-	EYE_12G_OR
I40trapErrorEye6GOverShootRising	I40TrapErrorTBL.91	-	-	EYE_6G_OR
I40trapErrorEye3GOverShootRising	I40TrapErrorTBL.92	-	-	EYE_3G_OR
I40trapErrorEyeHdOverShootRising	I40TrapErrorTBL.93	-	-	EYE_HD_OR
I40trapErrorEyeSdOverShootRising	I40TrapErrorTBL.94	-	-	EYE_SD_OR
I40trapErrorEye12GOverShoot Falling	I40TrapErrorTBL.95	-	-	EYE_12G_OF
I40trapErrorEye6GOverShootFalling	I40TrapErrorTBL.96	-	-	EYE_6G_OF
I40trapErrorEye3GOverShootFalling	I40TrapErrorTBL.97	-	-	EYE_3G_OF
I40trapErrorEyeHdOverShootFalling	I40TrapErrorTBL.98	-	-	EYE_HD_OF
I40trapErrorEyeSdOverShootFalling	I40TrapErrorTBL.99	-	-	EYE_SD_OF
I40trapErrorSdiLevelYUp	I40TrapErrorTBL.100	-	-	LEVEL_Y_UP
I40trapErrorSdiLevelYLo	I40TrapErrorTBL.101	-	-	LEVEL_Y_LO
I40trapErrorSdiGamutRUp	I40TrapErrorTBL.102	-	-	GAMUT_R_UP
I40trapErrorSdiGamutRLo	I40TrapErrorTBL.103	-	-	GAMUT_R_LO
I40trapErrorSdiGamutGUp	I40TrapErrorTBL.104	-	-	GAMUT_G_UP
I40trapErrorSdiGamutGLo	I40TrapErrorTBL.105	-	-	GAMUT_G_LO
I40trapErrorSdiGamutBUp	I40TrapErrorTBL.106	-	-	GAMUT_B_UP
I40trapErrorSdiGamutBLo	I40TrapErrorTBL.107	-	-	GAMUT_B_LO
I40trapErrorSdiLevelYUpSt2	I40TrapErrorTBL.108	-	-	LEVEL_Y_UP_ST2
I40trapErrorSdiLevelYLoSt2	I40TrapErrorTBL.109	-	-	LEVEL_Y_LO_ST2
I40trapErrorSdiGamutRUpSt2	I40TrapErrorTBL.110	-	-	GAMUT_R_UP_ST2
I40trapErrorSdiGamutRLoSt2	I40TrapErrorTBL.111	-	-	GAMUT_R_LO_ST2
I40trapErrorSdiGamutGUpSt2	I40TrapErrorTBL.112	-	-	GAMUT_G_UP_ST2
I40trapErrorSdiGamutGLoSt2	I40TrapErrorTBL.113	-	-	GAMUT_G_LO_ST2
I40trapErrorSdiGamutBUpSt2	I40TrapErrorTBL.114	-	-	GAMUT_B_UP_ST2
I40trapErrorSdiGamutBLoSt2	I40TrapErrorTBL.115	-	-	GAMUT_B_LO_ST2
I40trapErrorLogAudioValidity	I40TrapErrorTBL.120	-	-	VALIDITY:XX (where XX is the channel on which

20. NETWORK CONTROL

MIB	OID	SYNTAX	ACCESS	VALUE/RANGE
				the error is occurring in hexadecimal notation)
I40trapErrorLogAudioCrc	I40TrapErrorTBL.121	-	-	CRC:XX (where XX is the channel on which the error is occurring in hexadecimal notation)
I40trapErrorLogAudioClip	I40TrapErrorTBL.122	-	-	CLIP:XX (where XX is the channel on which the error is occurring in hexadecimal notation)
I40trapErrorLogAudioMute	I40TrapErrorTBL.123	-	-	MUTE:XX (where XX is the channel on which the error is occurring in hexadecimal notation)
I40trapErrorLogAudioLevelOver	I40TrapErrorTBL.124	-	-	LEVEL_OV:XX (where XX is the channel on which the error is occurring in hexadecimal notation)
I40trapErrorLogAudioParity	I40TrapErrorTBL.125	-	-	PARITY:XX (where XX is the channel on which the error is occurring in hexadecimal notation)
I40trapErrorLogAudioCodeViolation	I40TrapErrorTBL.126	-	-	CODE_VIL:XX (where XX is the channel on which the error is occurring in hexadecimal notation)
I40trapErrorIpFcs	I40TrapErrorTBL.150	-	-	FCS
I40trapErrorIpIpCs	I40TrapErrorTBL.151	-	-	IP_CS
I40trapErrorIpUdpCs	I40TrapErrorTBL.152	-	-	UDP_CS
I40trapErrorIpLossStream1	I40TrapErrorTBL.153	-	-	Video1_RTP_SN
I40trapErrorIpLossStream2	I40TrapErrorTBL.154	-	-	Video2_RTP_SN
I40trapErrorIpLossStream3	I40TrapErrorTBL.155	-	-	Video3_RTP_SN
I40trapErrorIpLossStream4	I40TrapErrorTBL.156	-	-	Video4_RTP_SN
I40trapErrorIpMbitStream1	I40TrapErrorTBL.157	-	-	Mbit_Stream1
I40trapErrorIpMbitStream2	I40TrapErrorTBL.158	-	-	Mbit_Stream2
I40trapErrorIpMbitStream3	I40TrapErrorTBL.159	-	-	Mbit_Stream3
I40trapErrorIpMbitStream4	I40TrapErrorTBL.160	-	-	Mbit_Stream4
I40trapErrorIpPtpUnlock	I40TrapErrorTBL.161	-	-	PTP_Unlock
I40trapErrorIpPtpGmid	I40TrapErrorTBL.162	-	-	PTP_GMID
I40trapErrorIpIntervalVariation1	I40TrapErrorTBL.163	-	-	Interval_Variation1
I40trapErrorIpIntervalVariation2	I40TrapErrorTBL.164	-	-	Interval_Variation2
I40trapErrorIpIntervalVariation3	I40TrapErrorTBL.165	-	-	Interval_Variation3
I40trapErrorIpIntervalVariation4	I40TrapErrorTBL.166	-	-	Interval_Variation4
I40trapErrorIpRtpTimingVideo1	I40TrapErrorTBL.167	-	-	Video1_RTP_Timing
I40trapErrorIpRtpTimingVideo2	I40TrapErrorTBL.168	-	-	Video2_RTP_Timing

20. NETWORK CONTROL

MIB	OID	SYNTAX	ACCESS	VALUE/RANGE
I40trapErrorIpRtpTimingVideo3	I40TrapErrorTBL.169	-	-	Video3_RTP_Timing
I40trapErrorIpRtpTimingVideo4	I40TrapErrorTBL.170	-	-	Video4_RTP_Timing
I40trapErrorIpRtpTimingAudio1	I40TrapErrorTBL.171	-	-	Audio1_RTP_Timing
I40trapErrorIpRtpTimingAudio2	I40TrapErrorTBL.172	-	-	Audio2_RTP_Timing
I40trapErrorIpRtpTimingAudio3	I40TrapErrorTBL.173	-	-	Audio3_RTP_Timing
I40trapErrorIpRtpTimingAudio4	I40TrapErrorTBL.174	-	-	Audio4_RTP_Timing
I40trapErrorIpRtpTimingAnc1	I40TrapErrorTBL.175	-	-	Anc1_RTP_Timing
I40trapErrorIpRtpTimingAnc2	I40TrapErrorTBL.176	-	-	Anc2_RTP_Timing
I40trapErrorIpRtpTimingAnc3	I40TrapErrorTBL.177	-	-	Anc3_RTP_Timing
I40trapErrorIpRtpTimingAnc4	I40TrapErrorTBL.178	-	-	Anc4_RTP_Timing
I40trapErrorIpVideo1Cmax	I40TrapErrorTBL.179	-	-	Video1_CMAX
I40trapErrorIpVideo2Cmax	I40TrapErrorTBL.180	-	-	Video2_CMAX
I40trapErrorIpVideo3Cmax	I40TrapErrorTBL.181	-	-	Video3_CMAX
I40trapErrorIpVideo4Cmax	I40TrapErrorTBL.182	-	-	Video4_CMAX
I40trapErrorIpVideo1Vrx	I40TrapErrorTBL.183	-	-	Video1_VRX
I40trapErrorIpVideo2Vrx	I40TrapErrorTBL.184	-	-	Video2_VRX
I40trapErrorIpVideo3Vrx	I40TrapErrorTBL.185	-	-	Video3_VRX
I40trapErrorIpVideo4Vrx	I40TrapErrorTBL.186	-	-	Video4_VRX
I40trapErrorIpPtpClockClass	I40TrapErrorTBL.187	-	-	PTP_ClockClass
I40trapErrorIpJpegXs	I40TrapErrorTBL.188	-	-	JPEG_XS:XX (XX is error code 2 to 99) 2 = Unsupported format error 5 = Image size error 7 = CAP marker error 8 = PIH marker error 9 = CDT marker error 10 = WGT marker error 11 = SLH marker error 12 = Precinct length error 13 = Codestream length error 14 = Codestream last error 99 = Unknown error
I40trapNormalTBL	I40trapContentTBL.2	Aggregate	-	-
I40trapNormalDetect	I40TrapNormalTBL.4	-	-	FORMAT_DETECT
I40trapNormalIpLinkUp	I40TrapNormalTBL.7	-	-	LINK_UP
I40trapNormalSdiCrc	I40TrapNormalTBL.20	-	-	CRC
I40trapNormalSdiEdh	I40TrapNormalTBL.21	-	-	EDH
I40trapNormalSdiTrsPosition	I40TrapNormalTBL.22	-	-	TRS_POSITION
I40trapNormalSdiTrsCode	I40TrapNormalTBL.23	-	-	TRS_CODE
I40trapNormalSdiIllegalCode	I40TrapNormalTBL.24	-	-	ILLEGAL_CODE
I40trapNormalSdiLineNumber	I40TrapNormalTBL.25	-	-	LINE_NUMBER
I40trapNormalCableError	I40TrapNormalTBL.26	-	-	CABLE_ERROR
I40trapNormalCableWarning	I40TrapNormalTBL.27	-	-	CABLE_WARNING

20. NETWORK CONTROL

MIB	OID	SYNTAX	ACCESS	VALUE/RANGE
I40trapNormalSdiAncChecksum	I40TrapNormalTBL.28	-	-	CHECK_SUM
I40trapNormalSdiAncParity	I40TrapNormalTBL.29	-	-	PARITY
I40trapNormalSdiGamut	I40TrapNormalTBL.30	-	-	GAMUT
I40trapNormalSdiGamutSt2	I40TrapNormalTBL.31	-	-	GAMUT_ST2
I40trapNormalSdiCompGamut	I40TrapNormalTBL.32	-	-	CMP_GAMUT
I40trapNormalSdiCompGamutSt2	I40TrapNormalTBL.33	-	-	CMP_GAMUT_ST2
I40trapNormalSdiFreeze	I40TrapNormalTBL.34	-	-	FREEZE
I40trapNormalSdiFreezeSt2	I40TrapNormalTBL.35	-	-	FREEZE_ST2
I40trapNormalSdiBlack	I40TrapNormalTBL.36	-	-	BLACK
I40trapNormalSdiBlackSt2	I40TrapNormalTBL.37	-	-	BLACK_ST2
I40trapNormalSdiLevelY	I40TrapNormalTBL.38	-	-	LEVEL_Y
I40trapNormalSdiLevelYSt2	I40TrapNormalTBL.39	-	-	LEVEL_Y_ST2
I40trapNormalSdiLevelC	I40TrapNormalTBL.40	-	-	LEVEL_C
I40trapNormalSdiLevelCSt2	I40TrapNormalTBL.41	-	-	LEVEL_C_ST2
I40trapNormalSdiAudioBch	I40TrapNormalTBL.42	-	-	AUDIO_BCH
I40trapNormalSdiAudioParity	I40TrapNormalTBL.43	-	-	AUDIO_PARITY
I40trapNormalSdiAudioDbn	I40TrapNormalTBL.44	-	-	AUDIO_DBN
I40trapNormalSdiAudioInhibit	I40TrapNormalTBL.45	-	-	AUDIO_INHIBIT
I40trapNormalSdiAudioSample	I40TrapNormalTBL.46	-	-	AUDIO_SAMPLE
I40trapNormalSdiFrequency	I40TrapNormalTBL.47	-	-	FREQUENCY
I40trapNormalSdiFormatAlarm	I40TrapNormalTBL.48	-	-	FORMAT_ALARM
I40trapNormalEye12GCurrentJitter	I40trapNormalTBL.60	-	-	EYE_12G_JITTER
I40trapNormalEye6GCurrentJitter	I40trapNormalTBL.61	-	-	EYE_6G_JITTER
I40trapNormalEye3GCurrentJitter	I40trapNormalTBL.62	-	-	EYE_3G_JITTER
I40trapNormalEyeHdCurrentJitter	I40trapNormalTBL.63	-	-	EYE_HD_JITTER
I40trapNormalEyeSdCurrentJitter	I40trapNormalTBL.64	-	-	EYE_SD_JITTER
I40trapNormalEye12GTimingJitter	I40trapNormalTBL.65	-	-	EYE_12G_T_JITTER
I40trapNormalEye6GTimingJitter	I40trapNormalTBL.66	-	-	EYE_6G_T_JITTER
I40trapNormalEye3GTimingJitter	I40trapNormalTBL.67	-	-	EYE_3G_T_JITTER
I40trapNormalEyeHdTimingJitter	I40trapNormalTBL.68	-	-	EYE_HD_T_JITTER
I40trapNormalEyeSdTimingJitter	I40trapNormalTBL.69	-	-	EYE_SD_T_JITTER
I40trapNormalEye12GDeltaTimeTrTf	I40trapNormalTBL.70	-	-	EYE_12G_TR_TF
I40trapNormalEye6GDeltaTimeTrTf	I40trapNormalTBL.71	-	-	EYE_6G_TR_TF
I40trapNormalEye3GDeltaTimeTrTf	I40trapNormalTBL.72	-	-	EYE_3G_TR_TF
I40trapNormalEyeHdDeltaTimeTrTf	I40trapNormalTBL.73	-	-	EYE_HD_TR_TF
I40trapNormalEyeSdDeltaTimeTrTf	I40trapNormalTBL.74	-	-	EYE_SD_TR_TF
I40trapNormalEye12GFalltime	I40trapNormalTBL.75	-	-	EYE_12G_TF
I40trapNormalEye6GFalltime	I40trapNormalTBL.76	-	-	EYE_6G_TF
I40trapNormalEye3GFalltime	I40trapNormalTBL.77	-	-	EYE_3G_TF
I40trapNormalEyeHdFalltime	I40trapNormalTBL.78	-	-	EYE_HD_TF

20. NETWORK CONTROL

MIB	OID	SYNTAX	ACCESS	VALUE/RANGE
I40trapNormalEyeSdFalltime	I40trapNormalTBL.79	-	-	EYE_SD_TF
I40trapNormalEye12GRisetime	I40trapNormalTBL.80	-	-	EYE_12G_TR
I40trapNormalEye6GRisetime	I40trapNormalTBL.81	-	-	EYE_6G_TR
I40trapNormalEye3GRisetime	I40trapNormalTBL.82	-	-	EYE_3G_TR
I40trapNormalEyeHdRisetime	I40trapNormalTBL.83	-	-	EYE_HD_TR
I40trapNormalEyeSdRisetime	I40trapNormalTBL.84	-	-	EYE_SD_TR
I40trapNormalEye12GAmp	I40trapNormalTBL.85	-	-	EYE_12G_AMP
I40trapNormalEye6GAmp	I40trapNormalTBL.86	-	-	EYE_6G_AMP
I40trapNormalEye3GAmp	I40trapNormalTBL.87	-	-	EYE_3G_AMP
I40trapNormalEyeHdAmp	I40trapNormalTBL.88	-	-	EYE_HD_AMP
I40trapNormalEyeSdAmp	I40trapNormalTBL.89	-	-	EYE_SD_AMP
I40trapNormalEye12GOverShootRising	I40trapNormalTBL.90	-	-	EYE_12G_OR
I40trapNormalEye6GOverShootRising	I40trapNormalTBL.91	-	-	EYE_6G_OR
I40trapNormalEye3GOverShootRising	I40trapNormalTBL.92	-	-	EYE_3G_OR
I40trapNormalEyeHdOverShootRising	I40trapNormalTBL.93	-	-	EYE_HD_OR
I40trapNormalEyeSdOverShootRising	I40trapNormalTBL.94	-	-	EYE_SD_OR
I40trapNormalEye12GOverShootFalling	I40trapNormalTBL.95	-	-	EYE_12G_OF
I40trapNormalEye6GOverShootFalling	I40trapNormalTBL.96	-	-	EYE_6G_OF
I40trapNormalEye3GOverShootFalling	I40trapNormalTBL.97	-	-	EYE_3G_OF
I40trapNormalEyeHdOverShootFalling	I40trapNormalTBL.98	-	-	EYE_HD_OF
I40trapNormalEyeSdOverShootFalling	I40trapNormalTBL.99	-	-	EYE_SD_OF
I40trapNormalSdiLevelYUp	I40TrapNormalTBL.100	-	-	LEVEL_Y_UP
I40trapNormalSdiLevelYLo	I40TrapNormalTBL.101	-	-	LEVEL_Y_LO
I40trapNormalSdiGamutRUp	I40TrapNormalTBL.102	-	-	GAMUT_R_UP
I40trapNormalSdiGamutRLo	I40TrapNormalTBL.103	-	-	GAMUT_R_LO
I40trapNormalSdiGamutGUp	I40TrapNormalTBL.104	-	-	GAMUT_G_UP
I40trapNormalSdiGamutGLo	I40TrapNormalTBL.105	-	-	GAMUT_G_LO
I40trapNormalSdiGamutBUp	I40TrapNormalTBL.106	-	-	GAMUT_B_UP
I40trapNormalSdiGamutBLo	I40TrapNormalTBL.107	-	-	GAMUT_B_LO
I40trapNormalSdiLevelYUpSt2	I40TrapNormalTBL.108	-	-	LEVEL_Y_UP_ST2
I40trapNormalSdiLevelYLoSt2	I40TrapNormalTBL.109	-	-	LEVEL_Y_LO_ST2
I40trapNormalSdiGamutRUpSt2	I40TrapNormalTBL.110	-	-	GAMUT_R_UP_ST2
I40trapNormalSdiGamutRLoSt2	I40TrapNormalTBL.111	-	-	GAMUT_R_LO_ST2
I40trapNormalSdiGamutGUpSt2	I40TrapNormalTBL.112	-	-	GAMUT_G_UP_ST2
I40trapNormalSdiGamutGLoSt2	I40TrapNormalTBL.113	-	-	GAMUT_G_LO_ST2
I40trapNormalSdiGamutBUpSt2	I40TrapNormalTBL.114	-	-	GAMUT_B_UP_ST2
I40trapNormalSdiGamutBLoSt2	I40TrapNormalTBL.115	-	-	GAMUT_B_LO_ST2
I40trapNormalLogAudioValidity	I40trapNormalTBL.120	-	-	VALIDITY
I40trapNormalLogAudioCrc	I40trapNormalTBL.121	-	-	CRC
I40trapNormalLogAudioClip	I40trapNormalTBL.122	-	-	CLIP
I40trapNormalLogAudioMute	I40trapNormalTBL.123	-	-	MUTE
I40trapNormalLogAudioLevelO	I40trapNormalTBL.124	-	-	LEVEL_OV

20. NETWORK CONTROL

MIB	OID	SYNTAX	ACCESS	VALUE/RANGE
ver				
I40trapNormalLogAudioParity	I40trapNormalTBL.125	-	-	PARITY
I40trapNormalLogAudioCodeVil olation	I40trapNormalTBL.126	-	-	CODE_VIL
I40trapNormalIpFcs	I40TrapNormalTBL.150	-	-	FCS
I40trapNormalIpIpCs	I40TrapNormalTBL.151	-	-	IP_CS
I40trapNormalIpUdpCs	I40TrapNormalTBL.152	-	-	UDP_CS
I40trapNormalIpVideo1RtpSeq uence	I40TrapNormalTBL.153	-	-	Video1_RTP_SN
I40trapNormalIpVideo2RtpSeq uence	I40TrapNormalTBL.154	-	-	Video2_RTP_SN
I40trapNormalIpVideo3RtpSeq uence	I40TrapNormalTBL.155	-	-	Video3_RTP_SN
I40trapNormalIpVideo4RtpSeq uence	I40TrapNormalTBL.156	-	-	Video4_RTP_SN
I40trapNormalIpMbitStream1	I40TrapNormalTBL.157	-	-	Mbit_Stream1
I40trapNormalIpMbitStream2	I40TrapNormalTBL.158	-	-	Mbit_Stream2
I40trapNormalIpMbitStream3	I40TrapNormalTBL.159	-	-	Mbit_Stream3
I40trapNormalIpMbitStream4	I40TrapNormalTBL.160	-	-	Mbit_Stream4
I40trapNormalIpPtpUnlock	I40TrapNormalTBL.161	-	-	PTP_Lock
I40trapNormalIpPtpGmid	I40TrapNormalTBL.162	-	-	PTP_GMID
I40trapNormalIpIntervalVariati on1	I40TrapNormalTBL.163	-	-	Interval_Variation1
I40trapNormalIpIntervalVariati on2	I40TrapNormalTBL.164	-	-	Interval_Variation2
I40trapNormalIpIntervalVariati on3	I40TrapNormalTBL.165	-	-	Interval_Variation3
I40trapNormalIpIntervalVariati on4	I40TrapNormalTBL.166	-	-	Interval_Variation4
I40trapNormalIpRtpTimingVide o1	I40TrapNormalTBL.167	-	-	Video1_RTP_Timing
I40trapNormalIpRtpTimingVide o2	I40TrapNormalTBL.168	-	-	Video2_RTP_Timing
I40trapNormalIpRtpTimingVide o3	I40TrapNormalTBL.169	-	-	Video3_RTP_Timing
I40trapNormalIpRtpTimingVide o4	I40TrapNormalTBL.170	-	-	Video4_RTP_Timing
I40trapNormalIpRtpTimingAudi o1	I40TrapNormalTBL.171	-	-	Audio1_RTP_Timing
I40trapNormalIpRtpTimingAudi o2	I40TrapNormalTBL.172	-	-	Audio2_RTP_Timing
I40trapNormalIpRtpTimingAudi o3	I40TrapNormalTBL.173	-	-	Audio3_RTP_Timing
I40trapNormalIpRtpTimingAudi o4	I40TrapNormalTBL.174	-	-	Audio4_RTP_Timing
I40trapNormalIpRtpTimingAnc 1	I40TrapNormalTBL.175	-	-	Anc1_RTP_Timing
I40trapNormalIpRtpTimingAnc 2	I40TrapNormalTBL.176	-	-	Anc2_RTP_Timing
I40trapNormalIpRtpTimingAnc 3	I40TrapNormalTBL.177	-	-	Anc3_RTP_Timing
I40trapNormalIpRtpTimingAnc 4	I40TrapNormalTBL.178	-	-	Anc4_RTP_Timing
I40trapNormalIpVideo1Cmax	I40TrapNormalTBL.179	-	-	Video1_CMAX
I40trapNormalIpVideo2Cmax	I40TrapNormalTBL.180	-	-	Video2_CMAX
I40trapNormalIpVideo3Cmax	I40TrapNormalTBL.181	-	-	Video3_CMAX
I40trapNormalIpVideo4Cmax	I40TrapNormalTBL.182	-	-	Video4_CMAX

20. NETWORK CONTROL

MIB	OID	SYNTAX	ACCESS	VALUE/RANGE
I40trapNormalIpVideo1Vrx	I40TrapNormalTBL.183	-	-	Video1_VRX
I40trapNormalIpVideo2Vrx	I40TrapNormalTBL.184	-	-	Video2_VRX
I40trapNormalIpVideo3Vrx	I40TrapNormalTBL.185	-	-	Video3_VRX
I40trapNormalIpVideo4Vrx	I40TrapNormalTBL.186	-	-	Video4_VRX
I40trapNormalIpPtpClockClass	I40trapNormalTBL.187	-	-	PTP_ClockClass
I40trapNormalIpJpegXs	I40trapNormalTBL.188	-	-	JPEG_XS
I40trapNormalNoError	I40TrapNormalTBL.1000	-	-	NO_ERROR
I40trapStrTBL	I40notificationTBL.2	Aggregate	-	-
I40trapCounter	I40trapStrTBL.1	INTEGER	R/O	1 to 4294967295
I40trapInternalTimestamp	I40trapStrTBL.2	DisplayString	R/O	Date and time
I40trapInputCh	I40trapStrTBL.3	INTEGER	R/O	1 = a 2 = b 3 = c 4 = d 5: no-assignment
I40trapInputSignal	I40trapStrTBL.4	DisplayString	R/O	Signal format
I40trapCableLen	I40trapStrTBL.5	INTEGER	R/O	0 to 32767
I40trapIpPort	I40trapStrTBL.6	INTEGER	R/O	1 = port1 2 = port2
I40trapIpPtpStatus	I40trapStrTBL.7	INTEGER	R/O	1 = lock 2 = unlock 3 = ready
I40trapIpPtpGmid	I40trapStrTBL.8	DisplayString	R/O	PTP GMID

• Trap Information Table

Trap No. (*1)	Trap Information Character String	Description	trapControl		Type	"NO_ERROR" Judgment
			Error	Normal		
1	FAN_STOP	Fan stop status detection	Y	N	Notification	N
2	NO_SIGNAL	No input signal detection	Y	N	Notification	N
3	FORMAT_UNKNOWN	Unknown signal format detection	Y	N	Notification	N
4	FORMAT_DETECT	Unprocessable signal format detection	N	Y	Notification	N
5	NTP_ERROR	NTP connection status detection	Y	N	Notification	N
6	LINK_DOWN	(IP) Incommunicable state detection	Y	N	Notification	N
7	LINK_UP	(IP) Communicable state detection	N	Y	Notification	N
20	CRC	CRC error detection	Y	Y	Status monitoring	Y
21	EDH	EDH error detection	Y	Y	Status monitoring	Y
22	TRS_POSITION	TRS Pos error detection	Y	Y	Status monitoring	Y
23	TRS_CODE	TRS Code error detection	Y	Y	Status monitoring	Y
24	ILLEGAL_CODE	Illegal command error detection	Y	Y	Status monitoring	Y
25	LINE_NUMBER	Line number error detection	Y	Y	Status monitoring	Y
26	CABLE_ERROR	Cable length measurement error detection	Y	Y	Status monitoring	Y
27	CABLE_WARNING	Cable length measurement warning detection	Y	Y	Status monitoring	Y
28	CHECK_SUM	Checksum error detection	Y	Y	Status monitoring	Y
29	PARITY	Parity error detection	Y	Y	Status monitoring	Y
30	GAMUT	Gamut error detection	Y	Y	Status	Y

20. NETWORK CONTROL

Trap No. (*1)	Trap Information Character String	Description	trapControl		Type	"NO_ERROR" Judgment
			Error	Normal		
					monitoring	
31	GAMUT_ST2	Gamut error detection (stream2)	Y	Y	Status monitoring	Y
32	CMP_GAMUT	Composite gamut error detection	Y	Y	Status monitoring	Y
33	CMP_GAMUT_ST2	Composite gamut error detection (stream2)	Y	Y	Status monitoring	Y
34	FREEZE	Freeze error detection	Y	Y	Status monitoring	Y
35	FREEZE_ST2	Freeze error detection (stream2)	Y	Y	Status monitoring	Y
36	BLACK	Black error detection	Y	Y	Status monitoring	Y
37	BLACK_ST2	Black error detection (stream2)	Y	Y	Status monitoring	Y
38	LEVEL_Y	Luminance level error detection	Y	Y	Status monitoring	Y
39	LEVEL_Y_ST2	Luminance level error detection (stream2)	Y	Y	Status monitoring	Y
40	LEVEL_C	Chrominance level error detection	Y	Y	Status monitoring	Y
41	LEVEL_C_ST2	Chrominance level error detection (stream2)	Y	Y	Status monitoring	Y
42	AUDIO_BCH	(EMB AUDIO) BCH error detection	Y	Y	Status monitoring	Y
43	AUDIO_PARITY	(EMB AUDIO) PARITY error detection	Y	Y	Status monitoring	Y
44	AUDIO_DBN	(EMB AUDIO) DBN error detection	Y	Y	Status monitoring	Y
45	AUDIO_INHIBIT	(EMB AUDIO) INH error detection	Y	Y	Status monitoring	Y
46	AUDIO_SAMPLE	(EMB AUDIO) SAMPLE error detection	Y	Y	Status monitoring	Y
47	FREQUENCY	FREQUENCY error detection	Y	Y	Status monitoring	Y
48	FORMAT_ALARM	Format alarm detection	Y	Y	Status monitoring	Y
49	COLOR_GAMUT	Color gamut error detection	Y	Y	Status monitoring	Y
50	COLOR_GAMUT_ST 2	Color gamut error detection (stream2)	Y	Y	Status monitoring	Y
51	MAX_FALL	MAX FALL error detection	Y	Y	Status monitoring	Y
52	MAX_FALL_ST2	MAX FALL error detection (stream2)	Y	Y	Status monitoring	Y
53	MAX_CLL	MAX CLL error detection	Y	Y	Status monitoring	Y
54	MAX_CLL_ST2	MAX CLL error detection (stream2)	Y	Y	Status monitoring	Y
60	EYE_12G_JITTER	(EYE) Current jitter error detection 12G	Y	Y	Status monitoring	Y
61	EYE_6G_JITTER	(EYE) Current jitter error detection 6G	Y	Y	Status monitoring	Y
62	EYE_3G_JITTER	(EYE) Current jitter error detection 3G	Y	Y	Status monitoring	Y
63	EYE_HD_JITTER	(EYE) Current jitter error detection	Y	Y	Status	Y

20. NETWORK CONTROL

Trap No. (*1)	Trap Information Character String	Description	trapControl		Type	"NO_ERROR" Judgment
			Error	Normal		
		HD			monitoring	
64	EYE_SD_JITTER	(EYE) Current jitter error detection SD	Y	Y	Status monitoring	Y
65	EYE_12G_T_JITTER	(EYE) Timing jitter error detection 12G	Y	Y	Status monitoring	Y
66	EYE_6G_T_JITTER	(EYE) Timing jitter error detection 6G	Y	Y	Status monitoring	Y
67	EYE_3G_T_JITTER	(EYE) Timing jitter error detection 3G	Y	Y	Status monitoring	Y
68	EYE_HD_T_JITTER	(EYE) Timing jitter error detection HD	Y	Y	Status monitoring	Y
69	EYE_SD_T_JITTER	(EYE) Timing jitter error detection SD	Y	Y	Status monitoring	Y
70	EYE_12G_TR_TF	(EYE) Delta Time error detection 12G	Y	Y	Status monitoring	Y
71	EYE_6G_TR_TF	(EYE) Delta Time error detection 6G	Y	Y	Status monitoring	Y
72	EYE_3G_TR_TF	(EYE) Delta Time error detection 3G	Y	Y	Status monitoring	Y
73	EYE_HD_TR_TF	(EYE) Delta Time error detection HD	Y	Y	Status monitoring	Y
74	EYE_SD_TR_TF	(EYE) Delta Time error detection SD	Y	Y	Status monitoring	Y
75	EYE_12G_TF	(EYE) Fall Time error detection 12G	Y	Y	Status monitoring	Y
76	EYE_6G_TF	(EYE) Fall Time error detection 6G	Y	Y	Status monitoring	Y
77	EYE_3G_TF	(EYE) Fall Time error detection 3G	Y	Y	Status monitoring	Y
78	EYE_HD_TF	(EYE) Fall Time error detection HD	Y	Y	Status monitoring	Y
79	EYE_SD_TF	(EYE) Fall Time error detection SD	Y	Y	Status monitoring	Y
80	EYE_12G_TR	(EYE) Rise Time error detection 12G	Y	Y	Status monitoring	Y
81	EYE_6G_TR	(EYE) Rise Time error detection 6G	Y	Y	Status monitoring	Y
82	EYE_3G_TR	(EYE) Rise Time error detection 3G	Y	Y	Status monitoring	Y
83	EYE_HD_TR	(EYE) Rise Time error detection HD	Y	Y	Status monitoring	Y
84	EYE_SD_TR	(EYE) Rise Time error detection SD	Y	Y	Status monitoring	Y
85	EYE_12G_AMP	(EYE) Amplitude error detection 12G	Y	Y	Status monitoring	Y
86	EYE_6G_AMP	(EYE) Amplitude error detection 6G	Y	Y	Status monitoring	Y
87	EYE_3G_AMP	(EYE) Amplitude error detection 3G	Y	Y	Status monitoring	Y
88	EYE_HD_AMP	(EYE) Amplitude error detection HD	Y	Y	Status monitoring	Y
89	EYE_SD_AMP	(EYE) Amplitude error detection SD	Y	Y	Status monitoring	Y
90	EYE_12G_OR	(EYE) Overshoot Rising error detection 12G	Y	Y	Status monitoring	Y
91	EYE_6G_OR	(EYE) Overshoot Rising error	Y	Y	Status	Y

20. NETWORK CONTROL

Trap No. (*1)	Trap Information Character String	Description	trapControl		Type	"NO_ERROR" Judgment
			Error	Normal		
		detection 6G			monitoring	
92	EYE_3G_OR	(EYE) Overshoot Rising error detection 3G	Y	Y	Status monitoring	Y
93	EYE_HD_OR	(EYE) Overshoot Rising error detection HD	Y	Y	Status monitoring	Y
94	EYE_SD_OR	(EYE) Overshoot Rising error detection SD	Y	Y	Status monitoring	Y
95	EYE_12G_OF	(EYE) Overshoot Falling error detection 12G	Y	Y	Status monitoring	Y
96	EYE_6G_OF	(EYE) Overshoot Falling error detection 6G	Y	Y	Status monitoring	Y
97	EYE_3G_OF	(EYE) Overshoot Falling error detection 3G	Y	Y	Status monitoring	Y
98	EYE_HD_OF	(EYE) Overshoot Falling error detection HD	Y	Y	Status monitoring	Y
99	EYE_SD_OF	(EYE) Overshoot Falling error detection SD	Y	Y	Status monitoring	Y
100	LEVEL_Y_UP	Luminance level error detection	Y	Y	Status monitoring	Y
101	LEVEL_Y_LO	Luminance level error detection	Y	Y	Status monitoring	Y
102	GAMUT_R_UP	Gamut error R UPPER detection	Y	Y	Status monitoring	Y
103	GAMUT_R_LO	Gamut error R LOWER detection	Y	Y	Status monitoring	Y
104	GAMUT_G_UP	Gamut error G UPPER detection	Y	Y	Status monitoring	Y
105	GAMUT_G_LO	Gamut error G LOWER detection	Y	Y	Status monitoring	Y
106	GAMUT_B_UP	Gamut error B UPPER detection	Y	Y	Status monitoring	Y
107	GAMUT_B_LO	Gamut error B LOWER detection	Y	Y	Status monitoring	Y
108	LEVEL_Y_UP_ST2	Luminance level error detection (stream2)	Y	Y	Status monitoring	Y
109	LEVEL_Y_LO_ST2	Luminance level error detection (stream2)	Y	Y	Status monitoring	Y
110	GAMUT_R_UP_ST2	Gamut error R UPPER detection (stream2)	Y	Y	Status monitoring	Y
111	GAMUT_R_LO_ST2	Gamut error R LOWER detection (stream2)	Y	Y	Status monitoring	Y
112	GAMUT_G_UP_ST2	Gamut error G UPPER detection (stream2)	Y	Y	Status monitoring	Y
113	GAMUT_G_LO_ST2	Gamut error G LOWER detection (stream2)	Y	Y	Status monitoring	Y
114	GAMUT_B_UP_ST2	Gamut error B UPPER detection (stream2)	Y	Y	Status monitoring	Y
115	GAMUT_B_LO_ST2	Gamut error B LOWER detection (stream2)	Y	Y	Status monitoring	Y
120	VALIDITY	(AUDIO) VALIDITY error detection	Y	Y	Status monitoring	N
121	CRC	(AUDIO) CRC error detection	Y	Y	Status monitoring	N
122	CLIP	(AUDIO) CLIP error detection	Y	Y	Status monitoring	N
123	MUTE	(AUDIO) MUTE error detection	Y	Y	Status	N

20. NETWORK CONTROL

Trap No. (*1)	Trap Information Character String	Description	trapControl		Type	"NO_ERROR" Judgment
			Error	Normal		
					monitoring	
124	LEVEL_OV	(AUDIO) LEVEL error detection	Y	Y	Status monitoring	N
125	PARITY	(AUDIO) PARITY error detection	Y	Y	Status monitoring	N
126	CODE_VIL	(AUDIO) CODE VIOLATION error detection	Y	Y	Status monitoring	N
150	FCS	(IP) FCS error detection	Y	Y	Status monitoring	Y
151	IP_CS	(IP) IP CS error detection	Y	Y	Status monitoring	Y
152	UDP_CS	(IP) UDP CS error detection	Y	Y	Status monitoring	Y
153	Video1_RTP_SN	(IP) Packet loss error detection	Y	Y	Status monitoring	Y
154	Video2_RTP_SN	(IP) Packet loss error detection	Y	Y	Status monitoring	Y
155	Video3_RTP_SN	(IP) Packet loss error detection	Y	Y	Status monitoring	Y
156	Video4_RTP_SN	(IP) Packet loss error detection	Y	Y	Status monitoring	Y
157	Mbit_Stream1	(IP) MarkerBit detection error detection	Y	Y	Status monitoring	Y
158	Mbit_Stream2	(IP) MarkerBit detection error detection	Y	Y	Status monitoring	Y
159	Mbit_Stream3	(IP) MarkerBit detection error detection	Y	Y	Status monitoring	Y
160	Mbit_Stream4	(IP) MarkerBit detection error detection	Y	Y	Status monitoring	Y
161	PTP_Unlock	(IP) PTP lock error detection	Y	Y	Status monitoring	Y
162	PTP_GMID	(IP) PTP GMID detection	Y	Y	Status monitoring	Y
163	Interval_Variation1	(IP) Packet jitter error detection	Y	Y	Status monitoring	Y
164	Interval_Variation2	(IP) Packet jitter error detection	Y	Y	Status monitoring	Y
165	Interval_Variation3	(IP) Packet jitter error detection	Y	Y	Status monitoring	Y
166	Interval_Variation4	(IP) Packet jitter error detection	Y	Y	Status monitoring	Y
167	Video1_RTP_Timing	(IP) Video1 RTP-PTP time difference error detection	Y	Y	Status monitoring	Y
168	Video2_RTP_Timing	(IP) Video2 RTP-PTP time difference error detection	Y	Y	Status monitoring	Y
169	Video3_RTP_Timing	(IP) Video3 RTP-PTP time difference error detection	Y	Y	Status monitoring	Y
170	Video4_RTP_Timing	(IP) Video4 RTP-PTP time difference error detection	Y	Y	Status monitoring	Y
171	Audio1_RTP_Timing	(IP) Audio1 RTP-PTP time difference error detection	Y	Y	Status monitoring	Y
172	Audio2_RTP_Timing	(IP) Audio2 RTP-PTP time difference error detection	Y	Y	Status monitoring	Y
173	Audio3_RTP_Timing	(IP) Audio3 RTP-PTP time difference error detection	Y	Y	Status monitoring	Y
174	Audio4_RTP_Timing	(IP) Audio4 RTP-PTP time difference	Y	Y	Status	Y

20. NETWORK CONTROL

Trap No. (*1)	Trap Information Character String	Description	trapControl		Type	"NO_ERROR" Judgment
			Error	Normal		
		error detection			monitoring	
175	Anc1_RTP_Timing	(IP) ANC1 RTP-PTP time difference error detection	Y	Y	Status monitoring	Y
176	Anc2_RTP_Timing	(IP) ANC2 RTP-PTP time difference error detection	Y	Y	Status monitoring	Y
177	Anc3_RTP_Timing	(IP) ANC3 RTP-PTP time difference error detection	Y	Y	Status monitoring	Y
178	Anc4_RTP_Timing	(IP) ANC4 RTP-PTP time difference error detection	Y	Y	Status monitoring	Y
179	Video1_CMAX	(IP) Video1 Cinst error detection	Y	Y	Status monitoring	Y
180	Video2_CMAX	(IP) Video2 Cinst error detection	Y	Y	Status monitoring	Y
181	Video3_CMAX	(IP) Video3 Cinst error detection	Y	Y	Status monitoring	Y
182	Video4_CMAX	(IP) Video4 Cinst error detection	Y	Y	Status monitoring	Y
183	Video1_VRX	(IP) Video1 VRX error detection	Y	Y	Status monitoring	Y
184	Video2_VRX	(IP) Video2 VRX error detection	Y	Y	Status monitoring	Y
185	Video3_VRX	(IP) Video3 VRX error detection	Y	Y	Status monitoring	Y
186	Video4_VRX	(IP) Video4 VRX error detection	Y	Y	Status monitoring	Y
187	PTP_ClockClass	(IP) PTP ClockClass change detection	N	Y	Status monitoring	N
188	JPEG_XS	(IP) JPEG XS error detection	Y	Y	Status monitoring	Y
1000 (*2)	NO_ERROR	No error	N	Y	-	-

*1 Each OID number of I40TrapErrorTBL(1) and I40TrapNormalTBL(2) of I40trapContentTBL(1)

*2 I40trapNormalNoError(1000) is only defined for I40trapNormalTBL(2) and is not available for I40trapErrorTBL(1).

21. MENU TREE

This chapter shows the menu trees that correspond to each key.
The default settings are underlined.

The menus and default values that are displayed vary depending on the instrument's settings, the configuration of options, and whether a USB memory device is connected to the instrument.

21.1 INPUT Menu

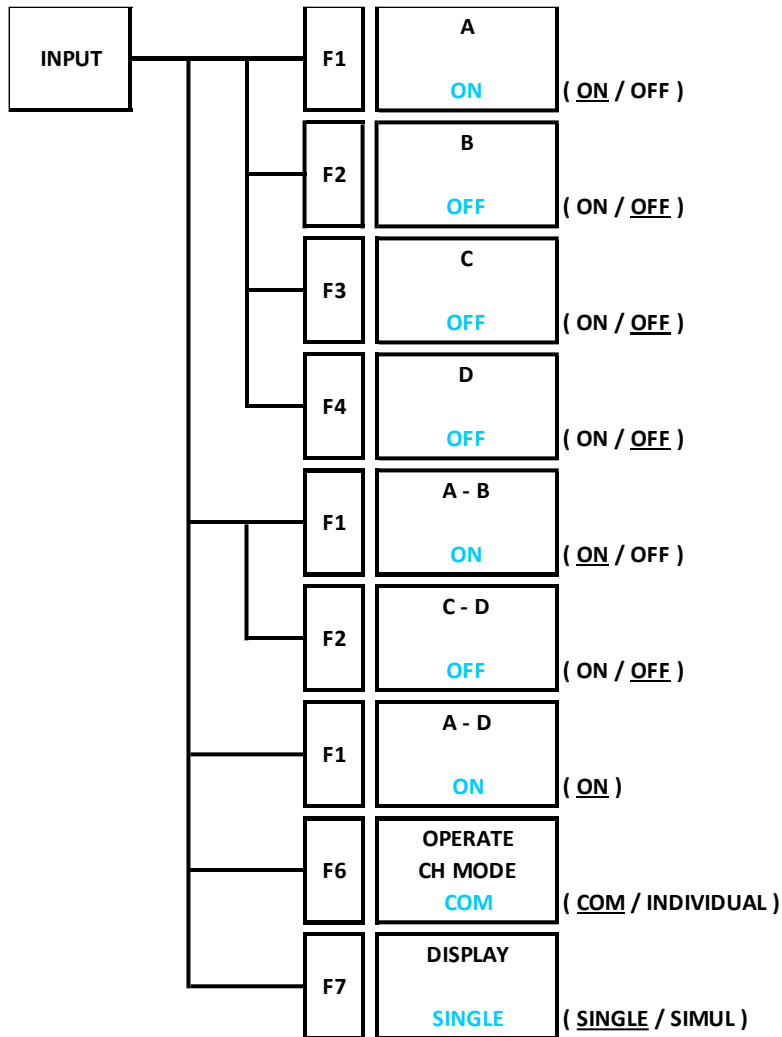

21. MENU TREE

21.2 SYS Menu

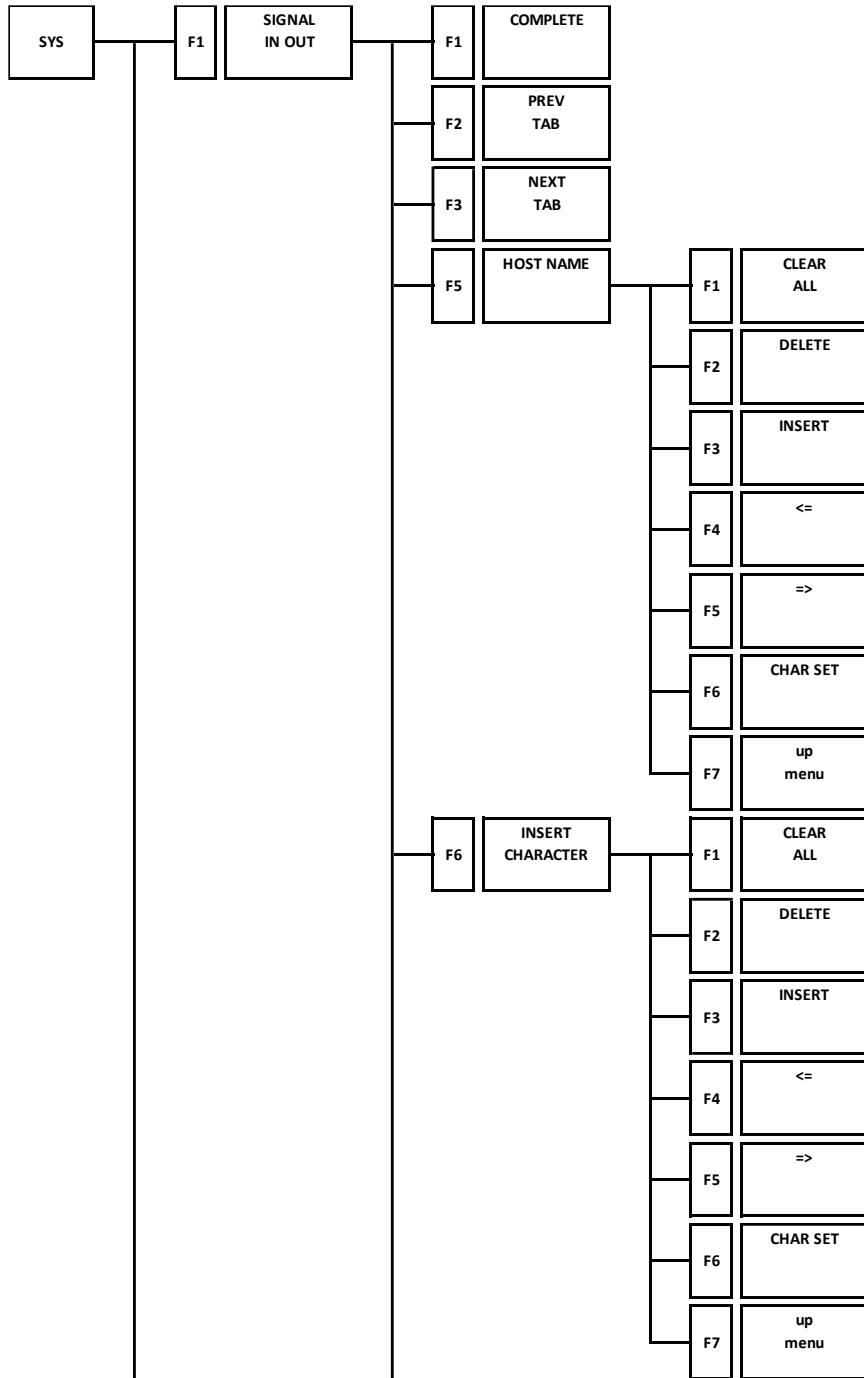

21. MENU TREE

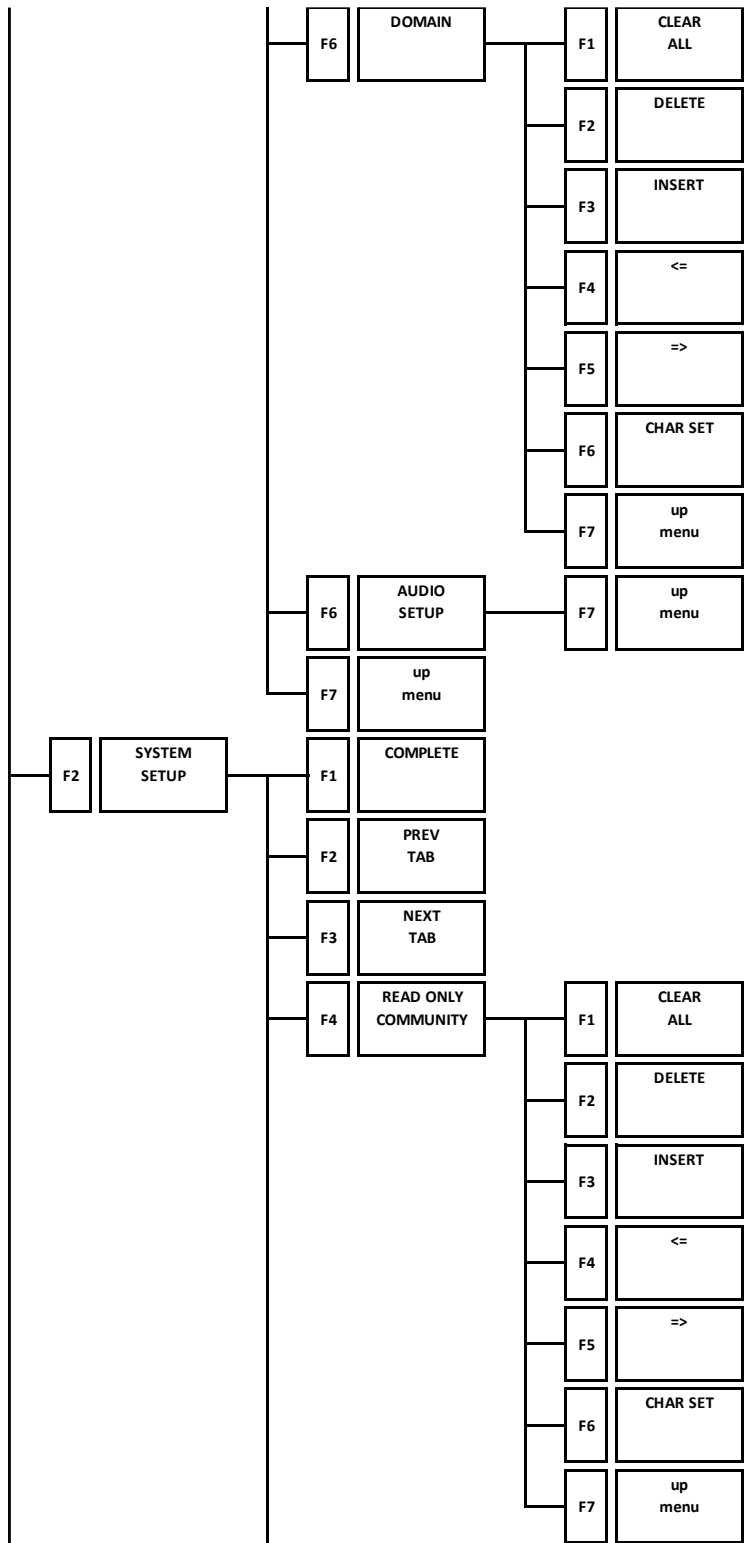

21. MENU TREE

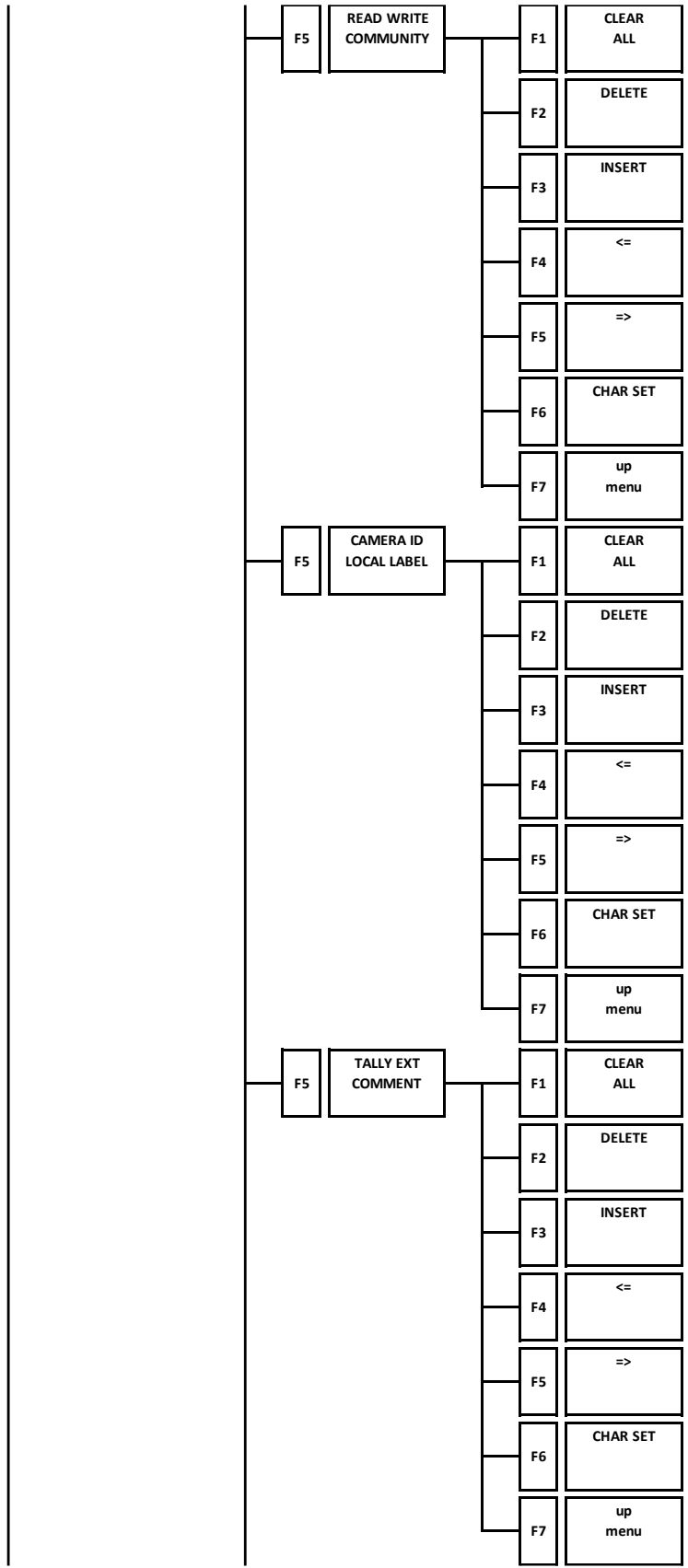

21. MENU TREE

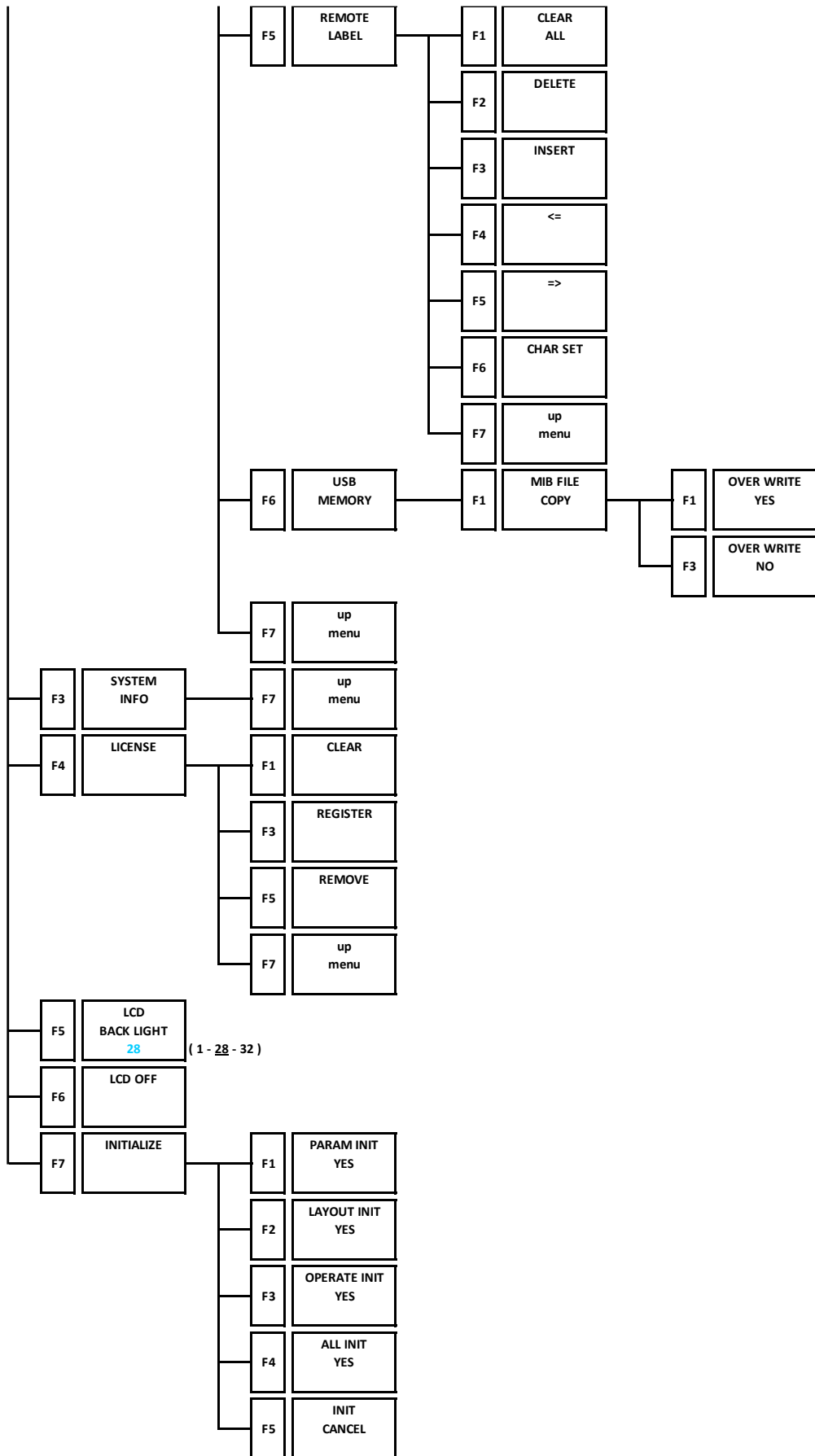

21. MENU TREE

21.3 CAP Menu

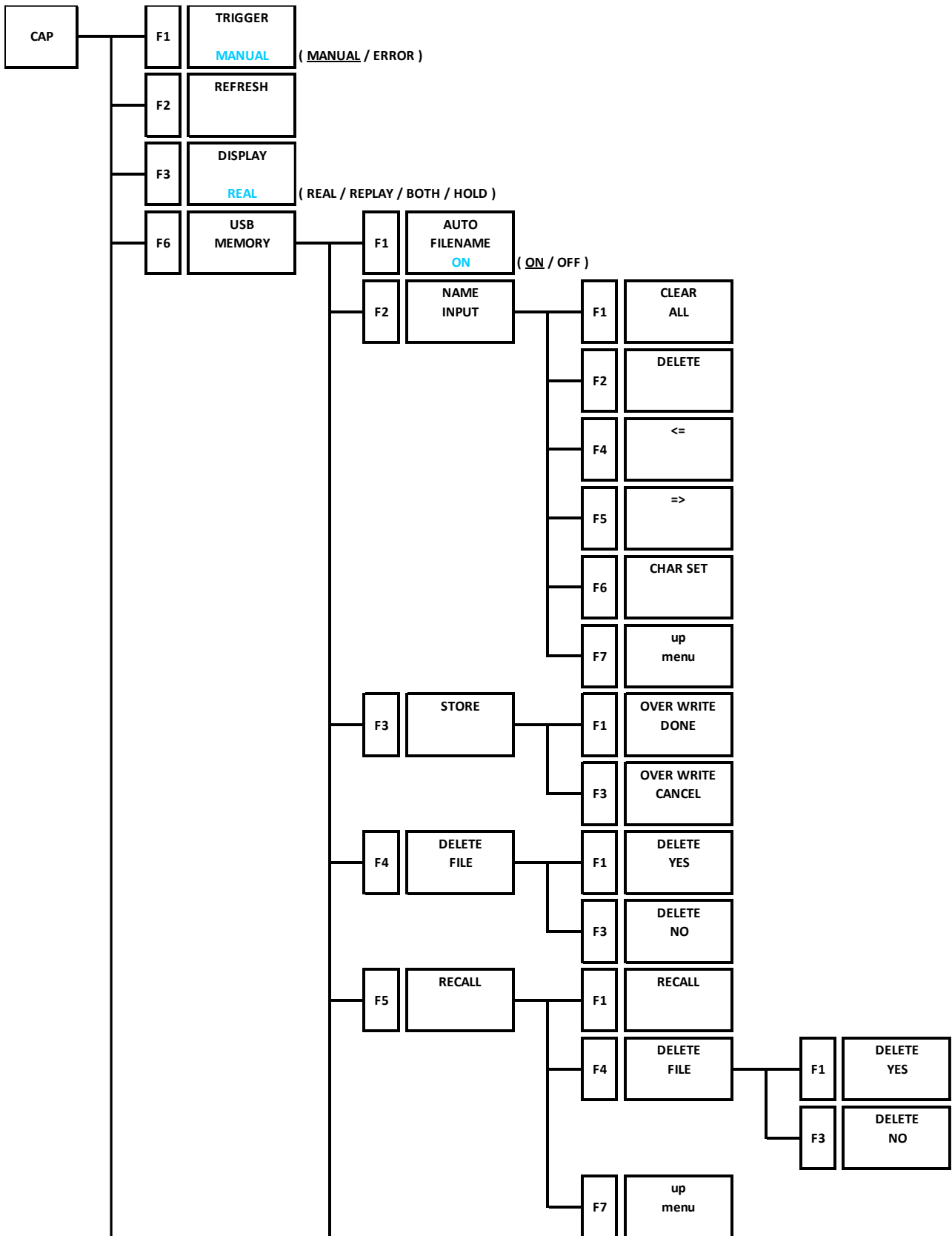

21. MENU TREE

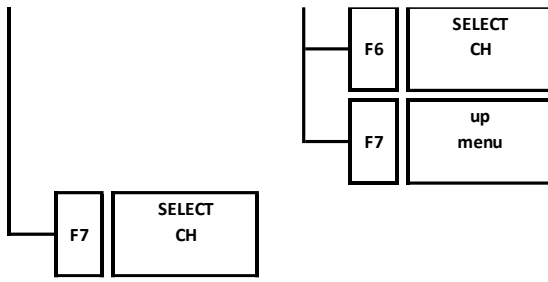

21. MENU TREE

21.4 MEM Menu

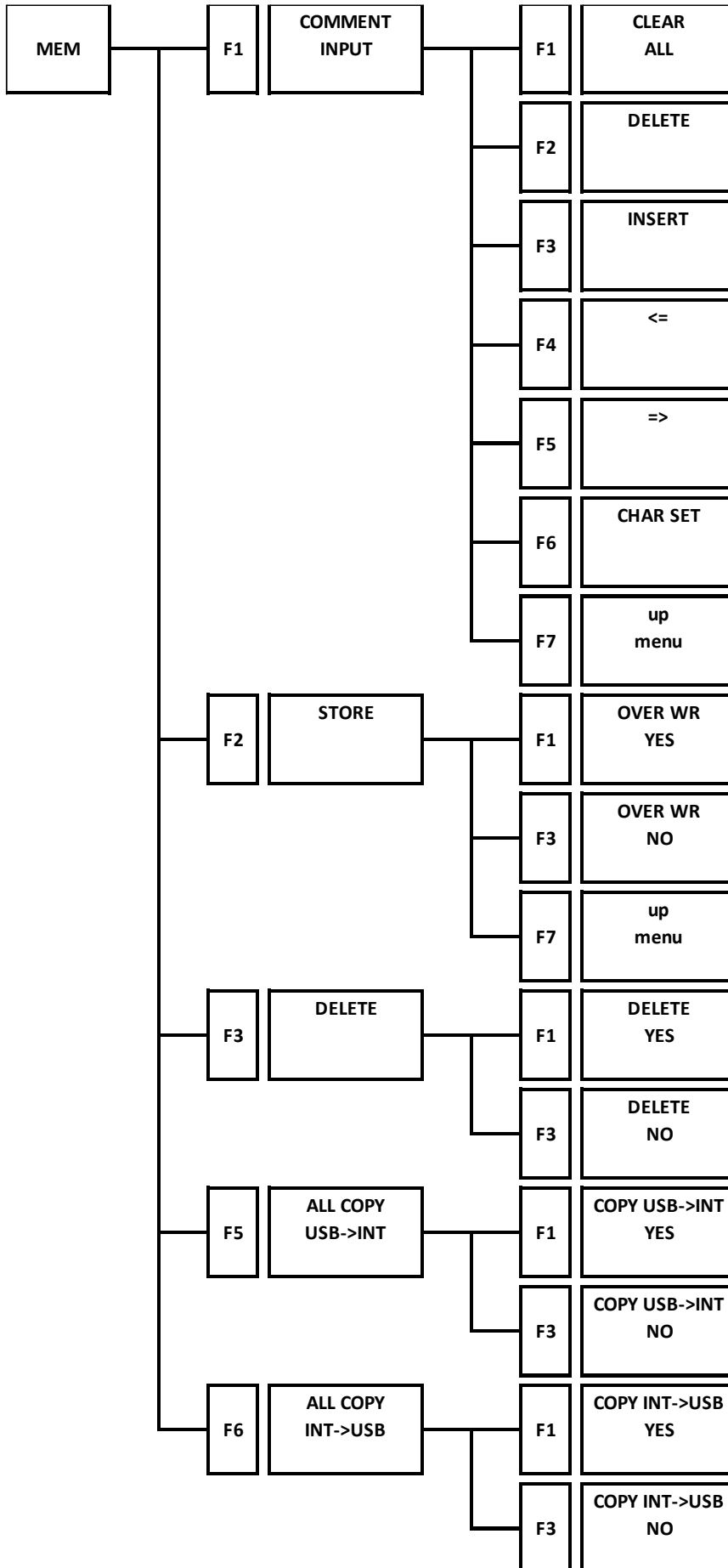

21.5 RECALL Menu

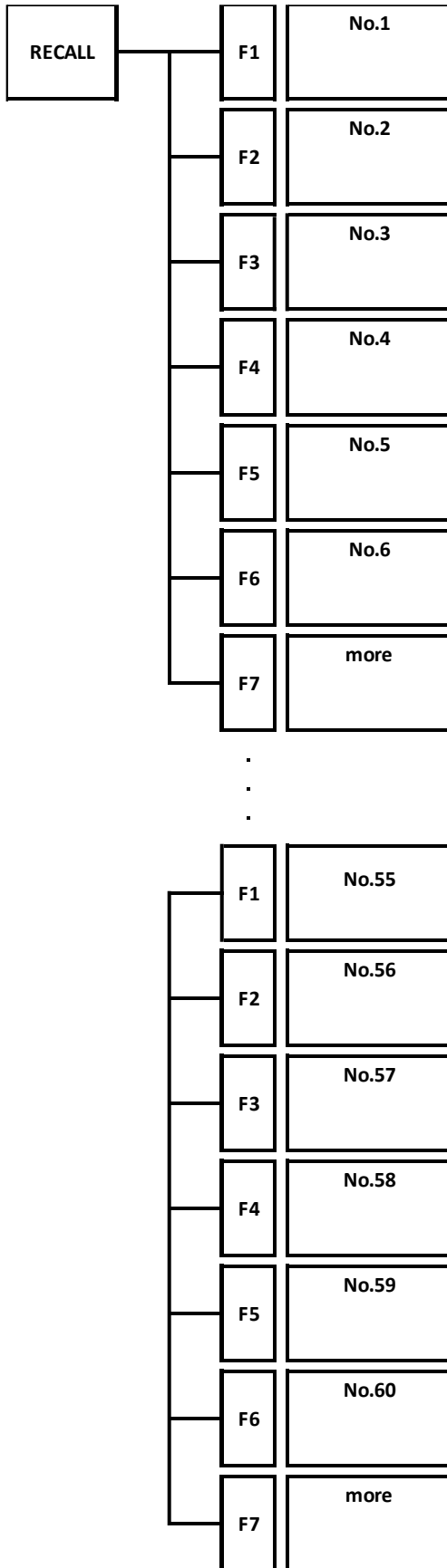

21. MENU TREE

21.6 WFM Menu

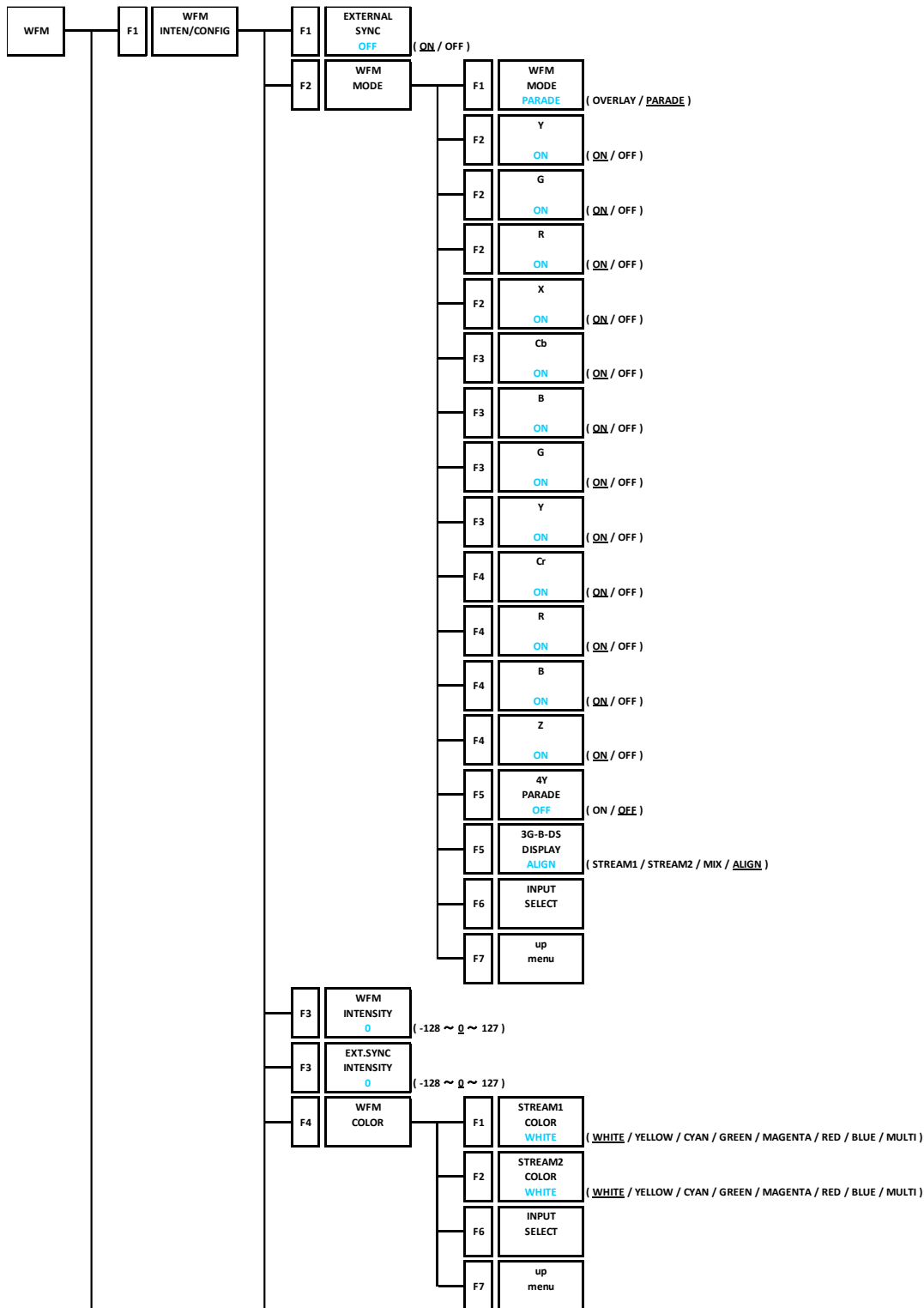

21. MENU TREE

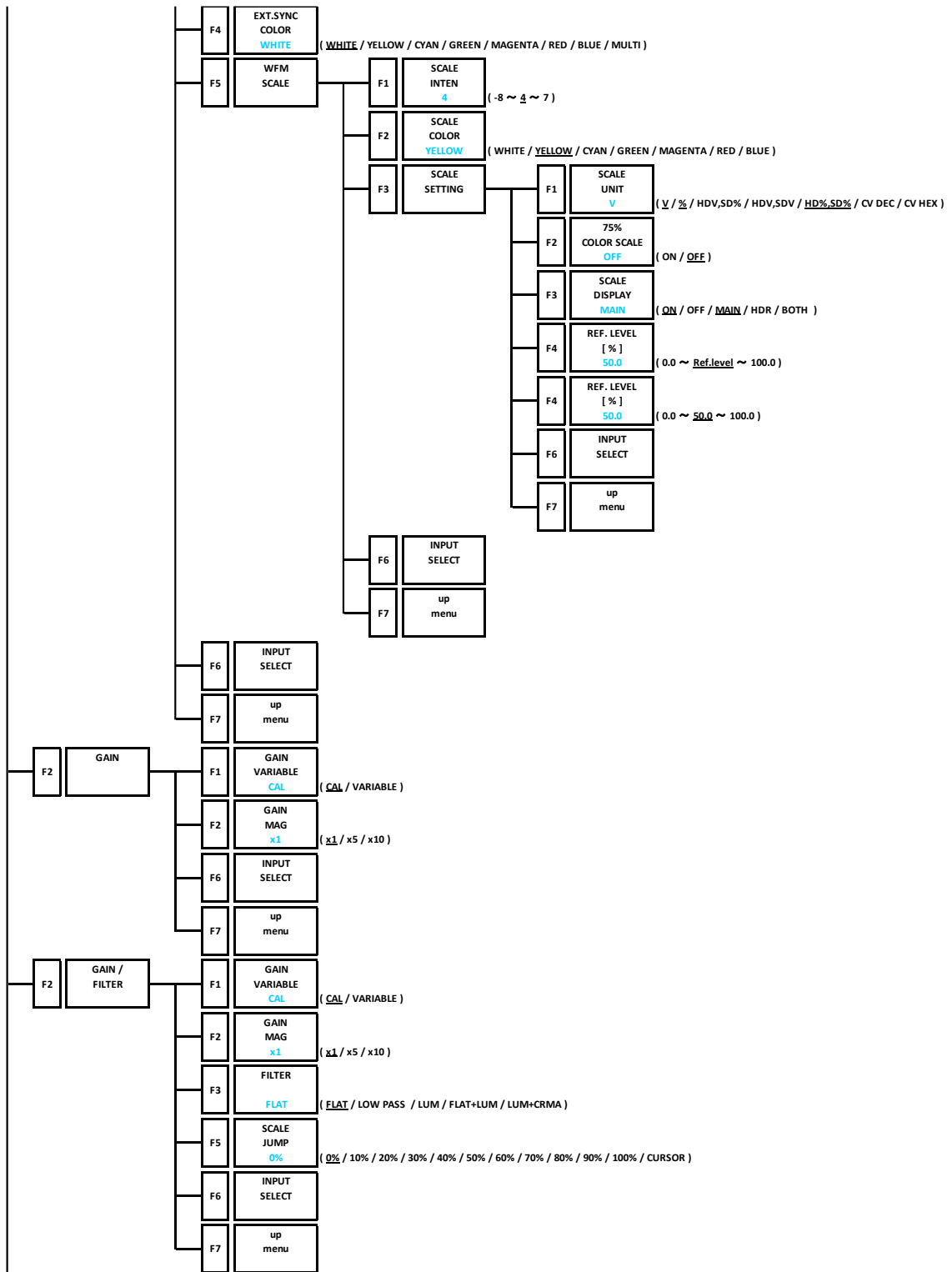

21. MENU TREE

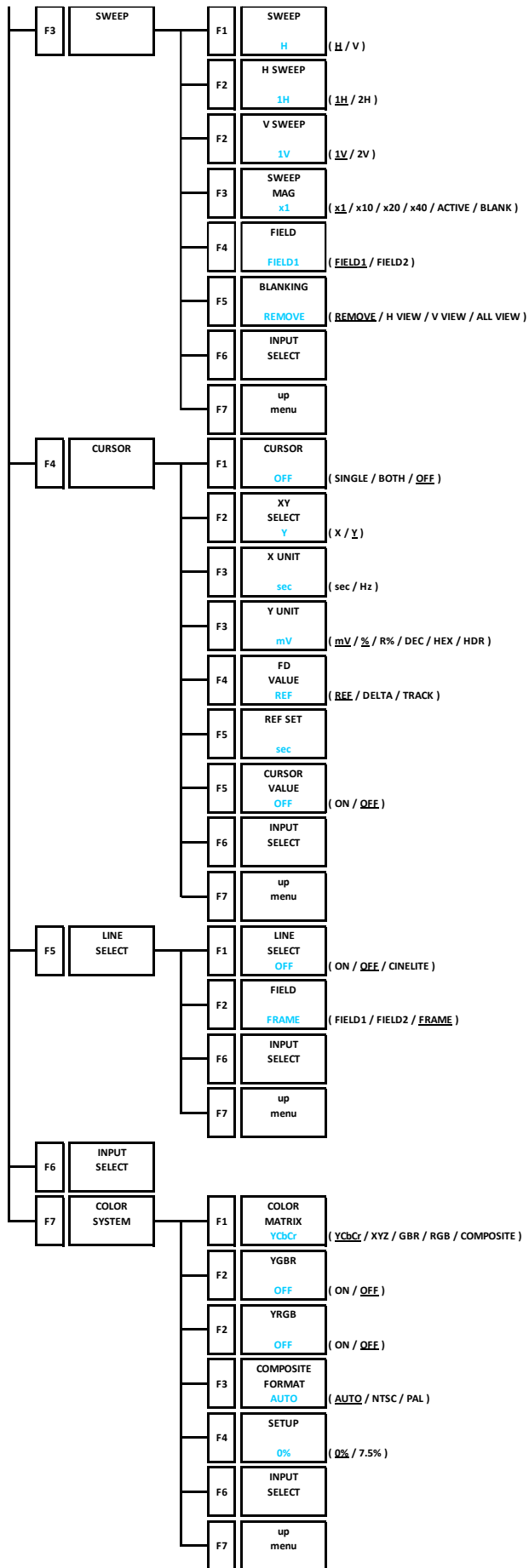

21. MENU TREE

21.7 VECT Menu

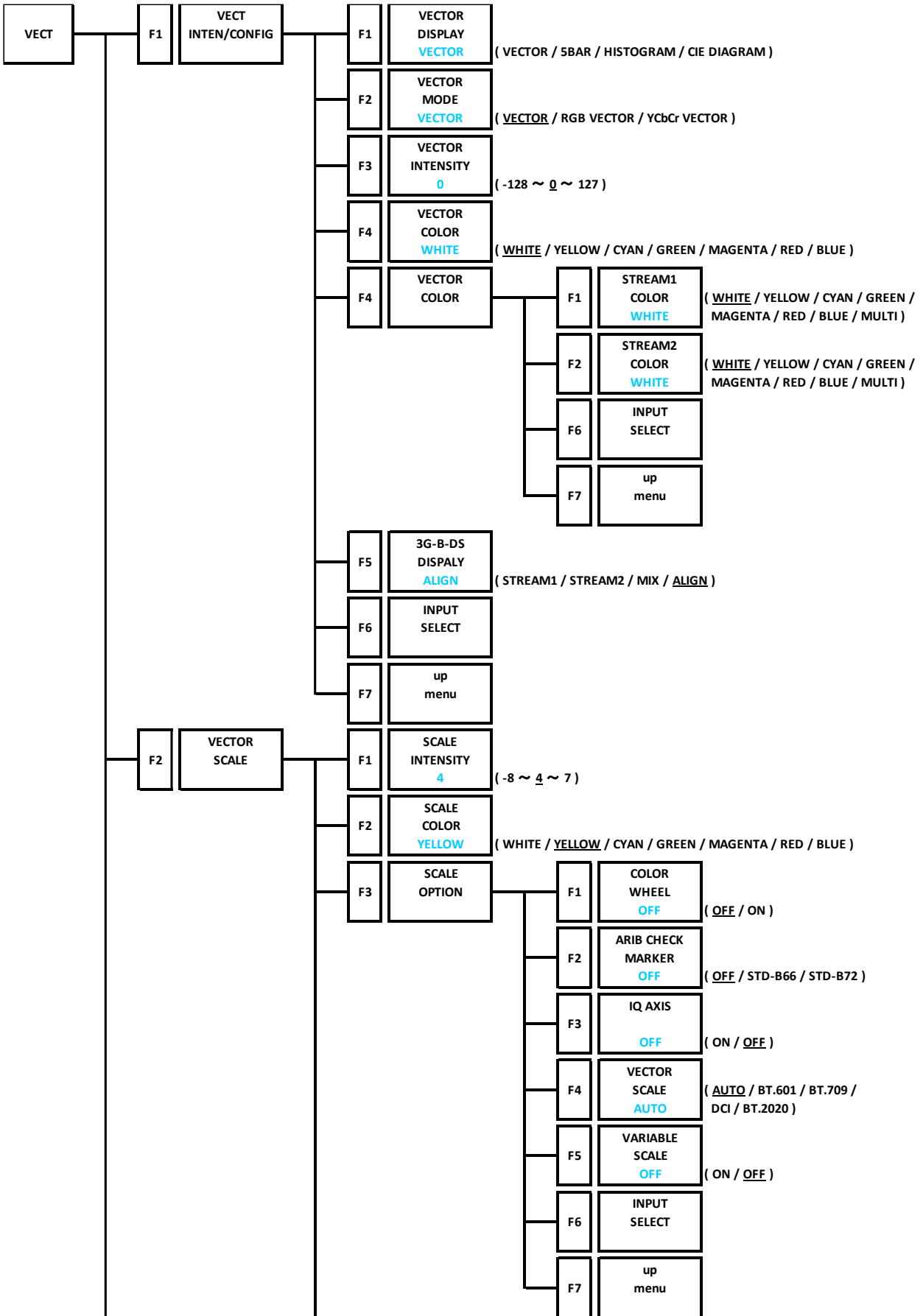

21. MENU TREE

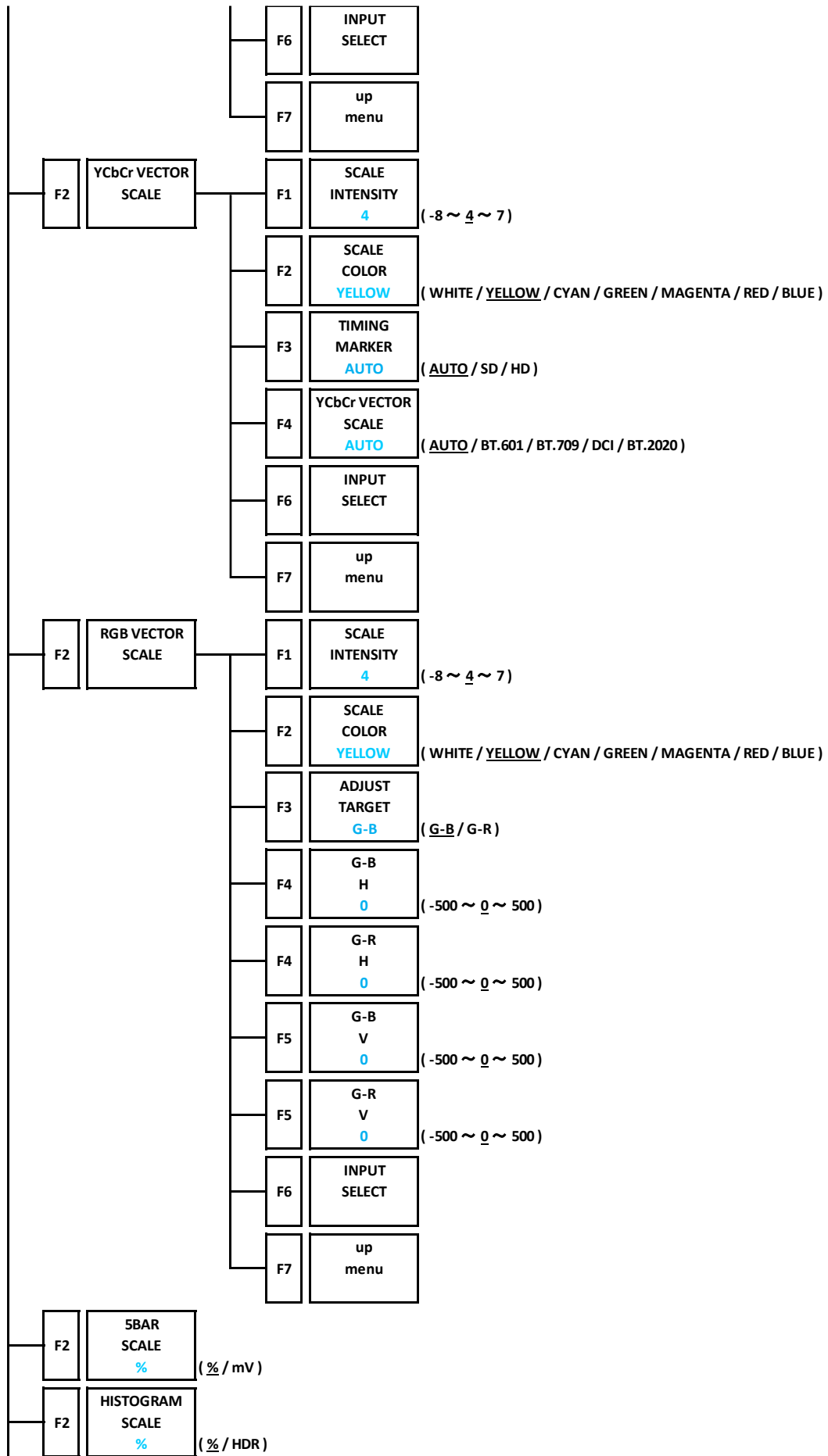

21. MENU TREE

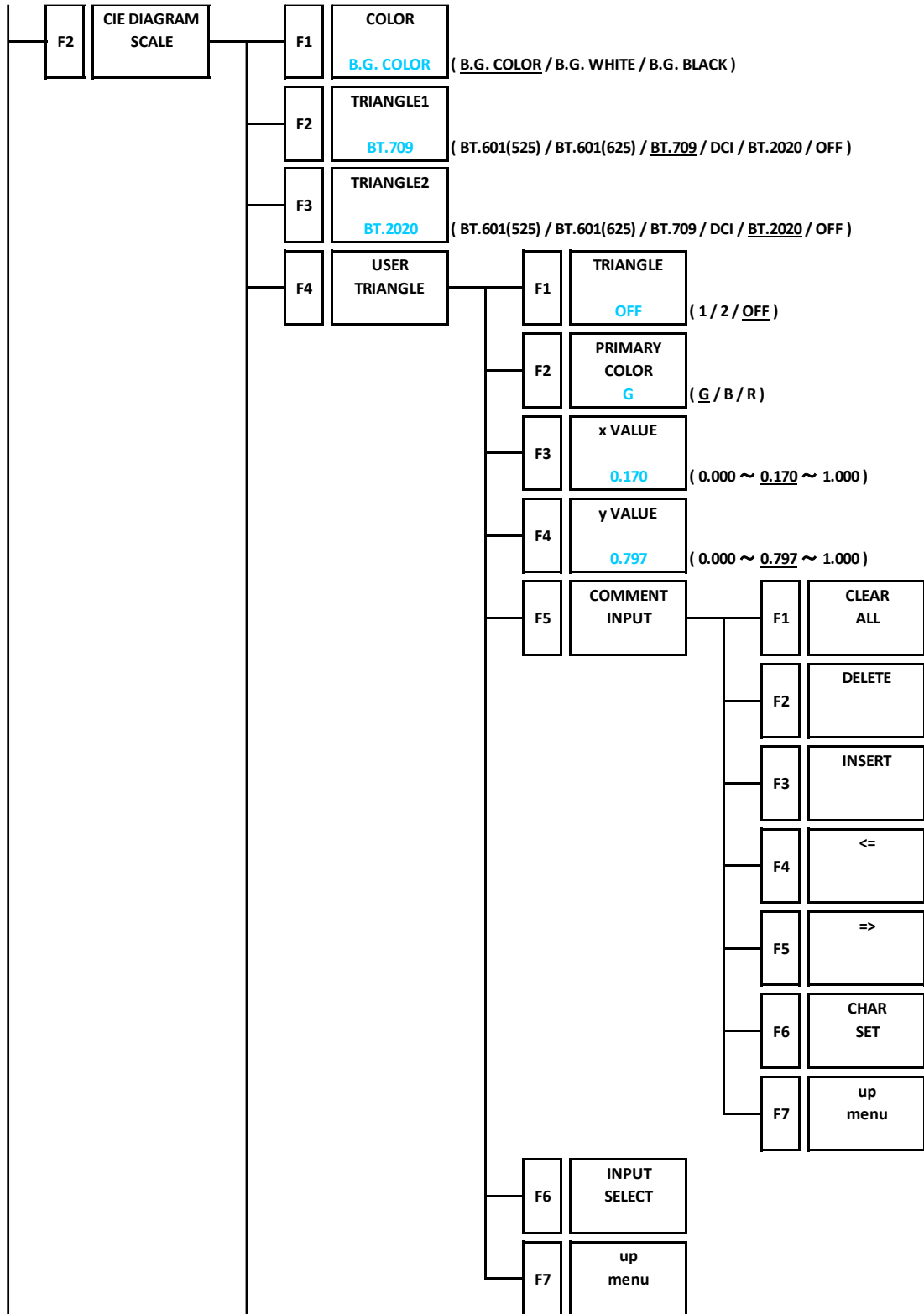

21. MENU TREE

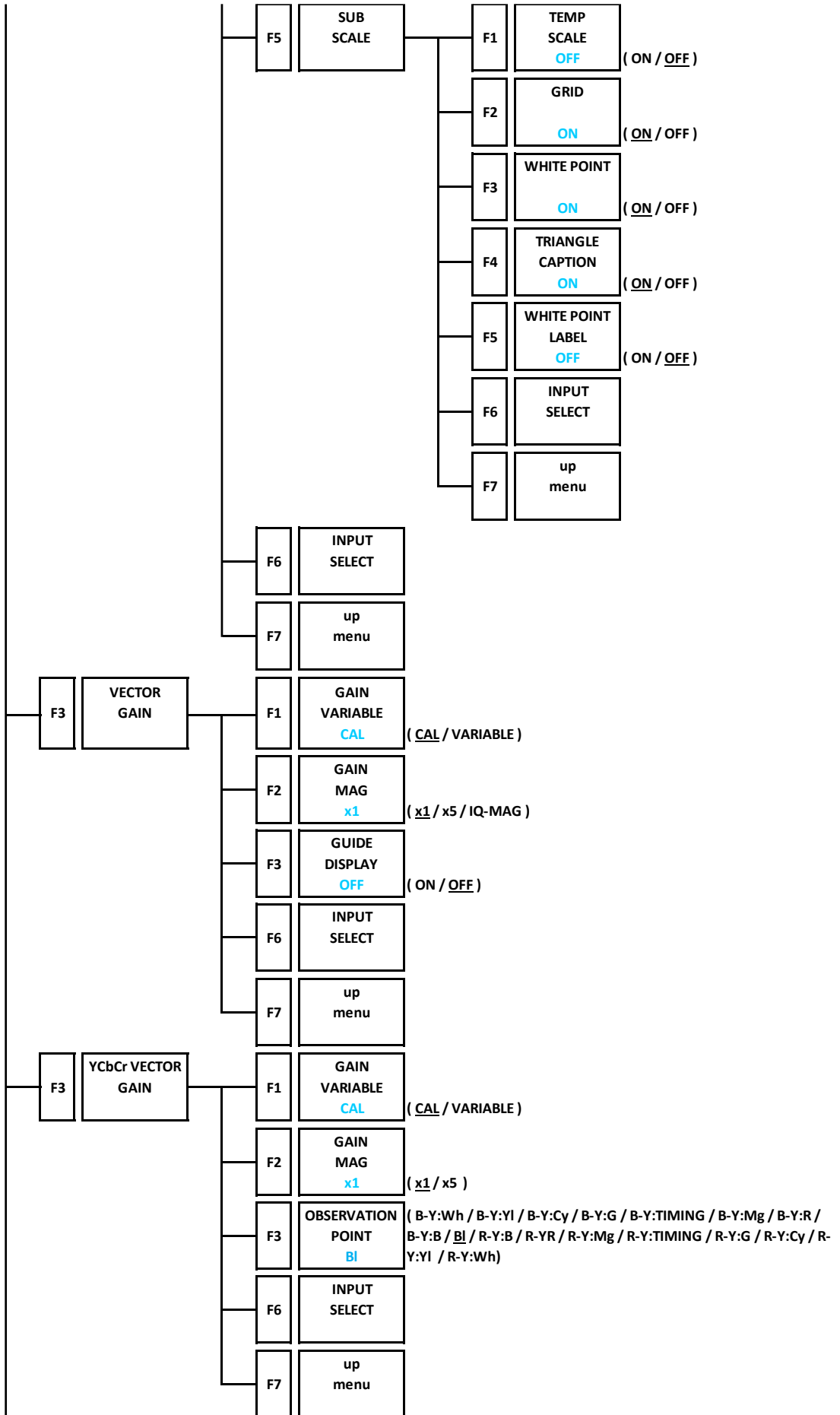

21. MENU TREE

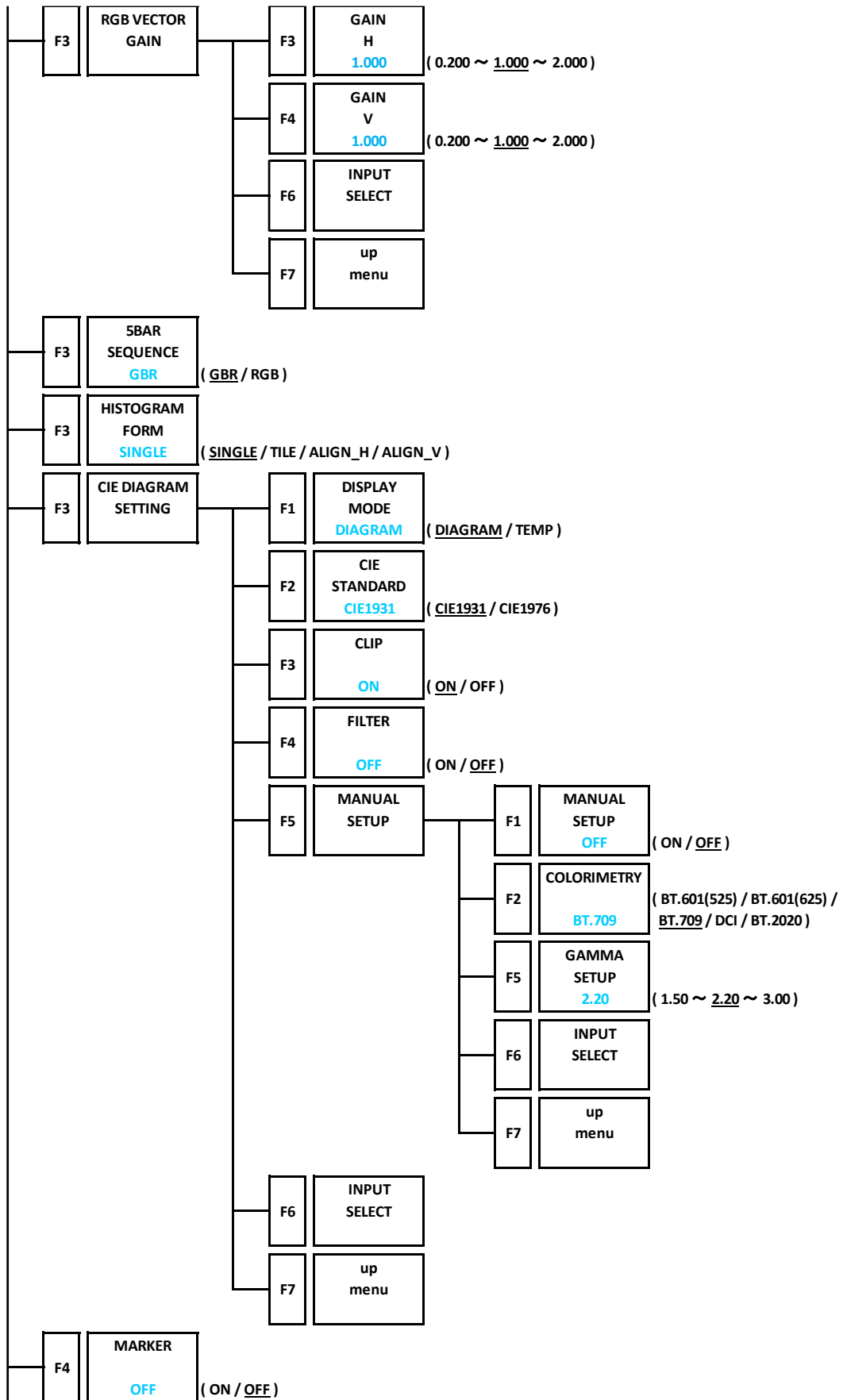

21. MENU TREE

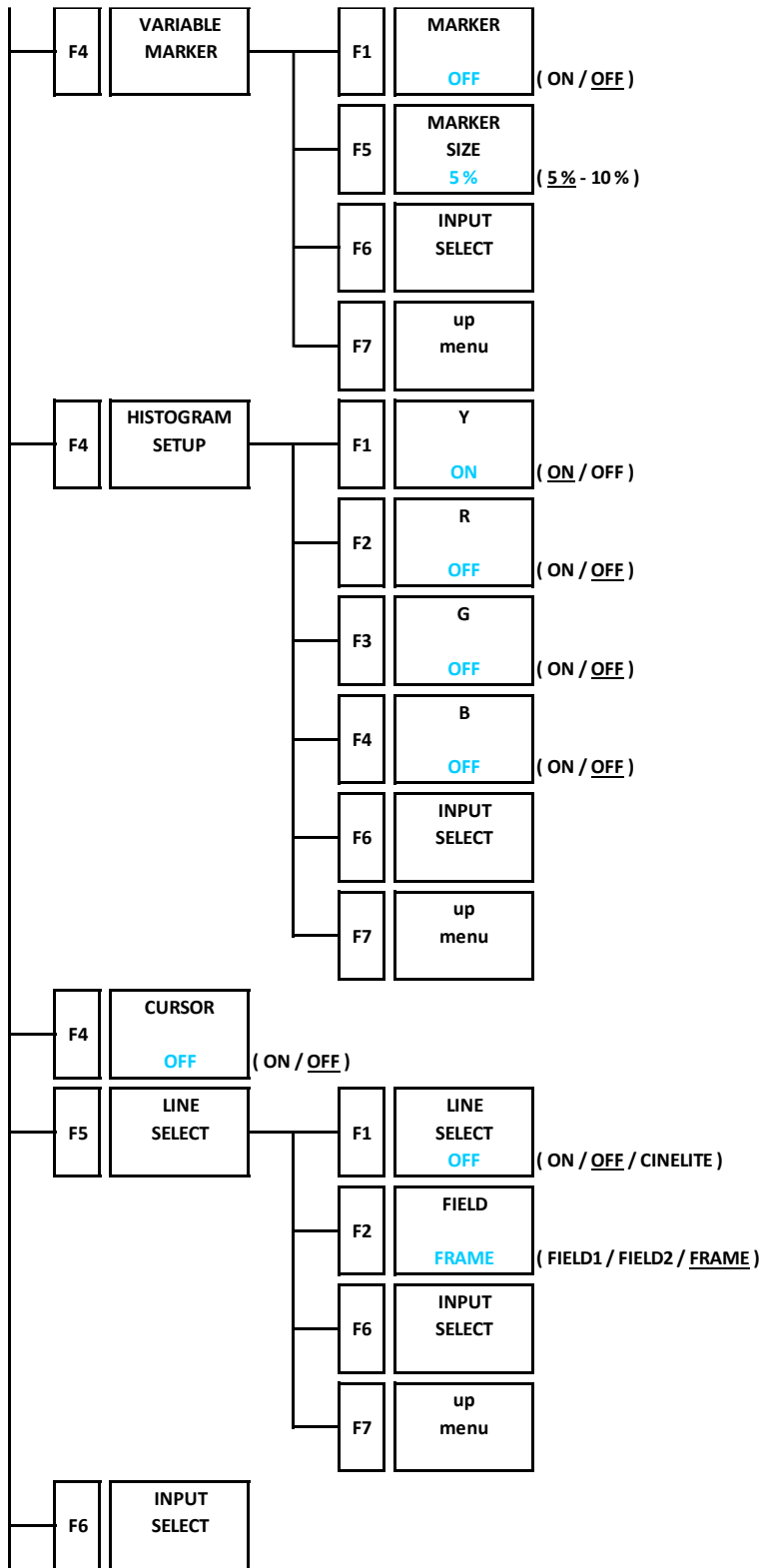

21. MENU TREE

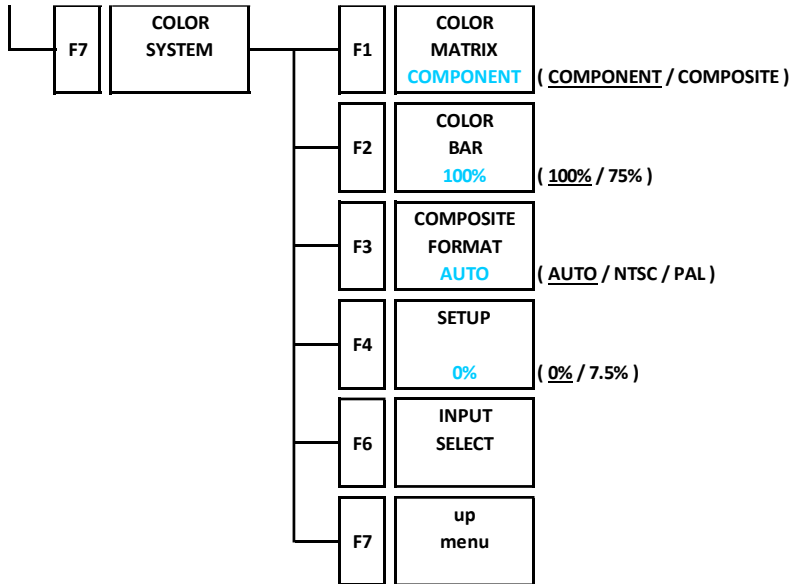

21. MENU TREE

21.8 PIC Menu

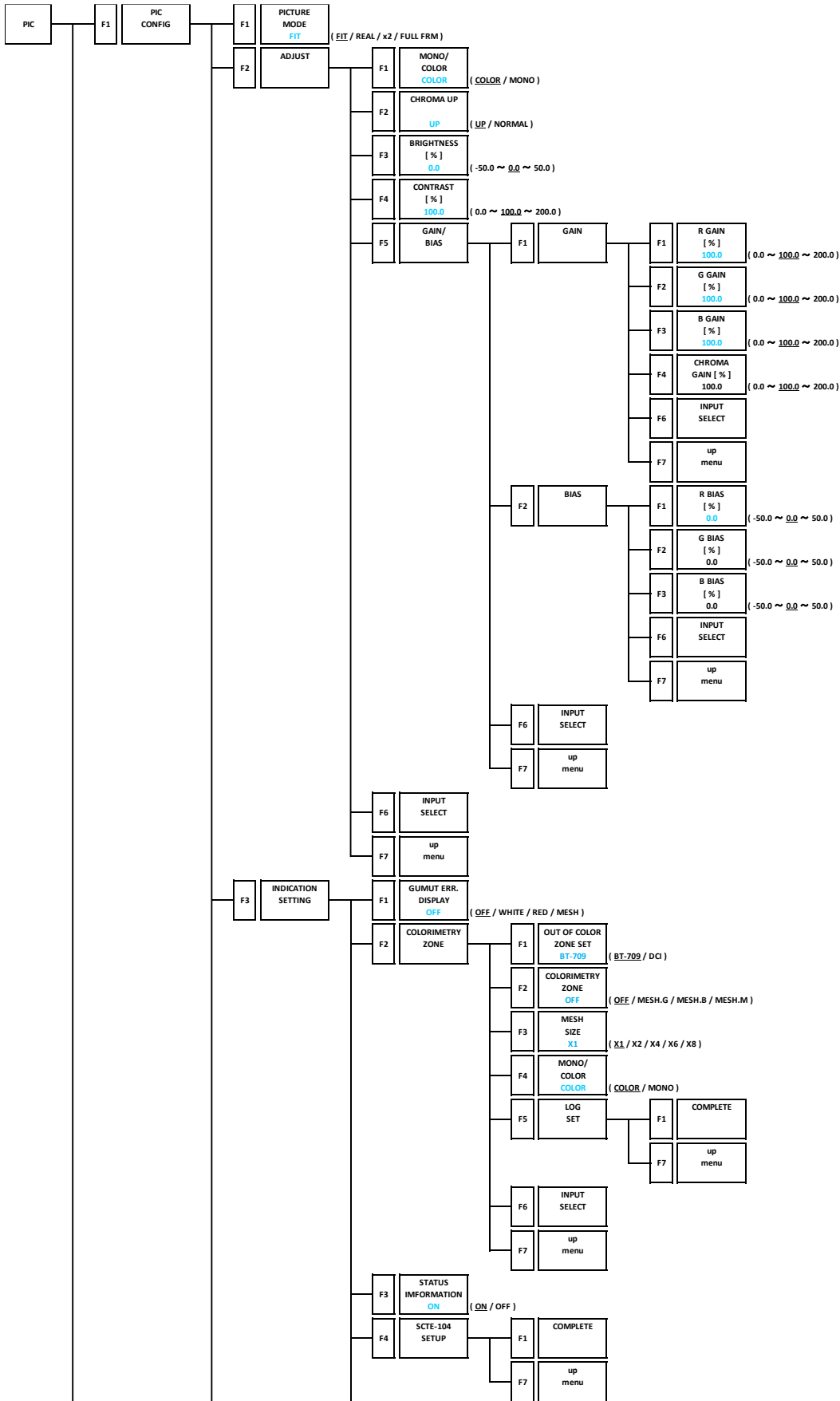

21. MENU TREE

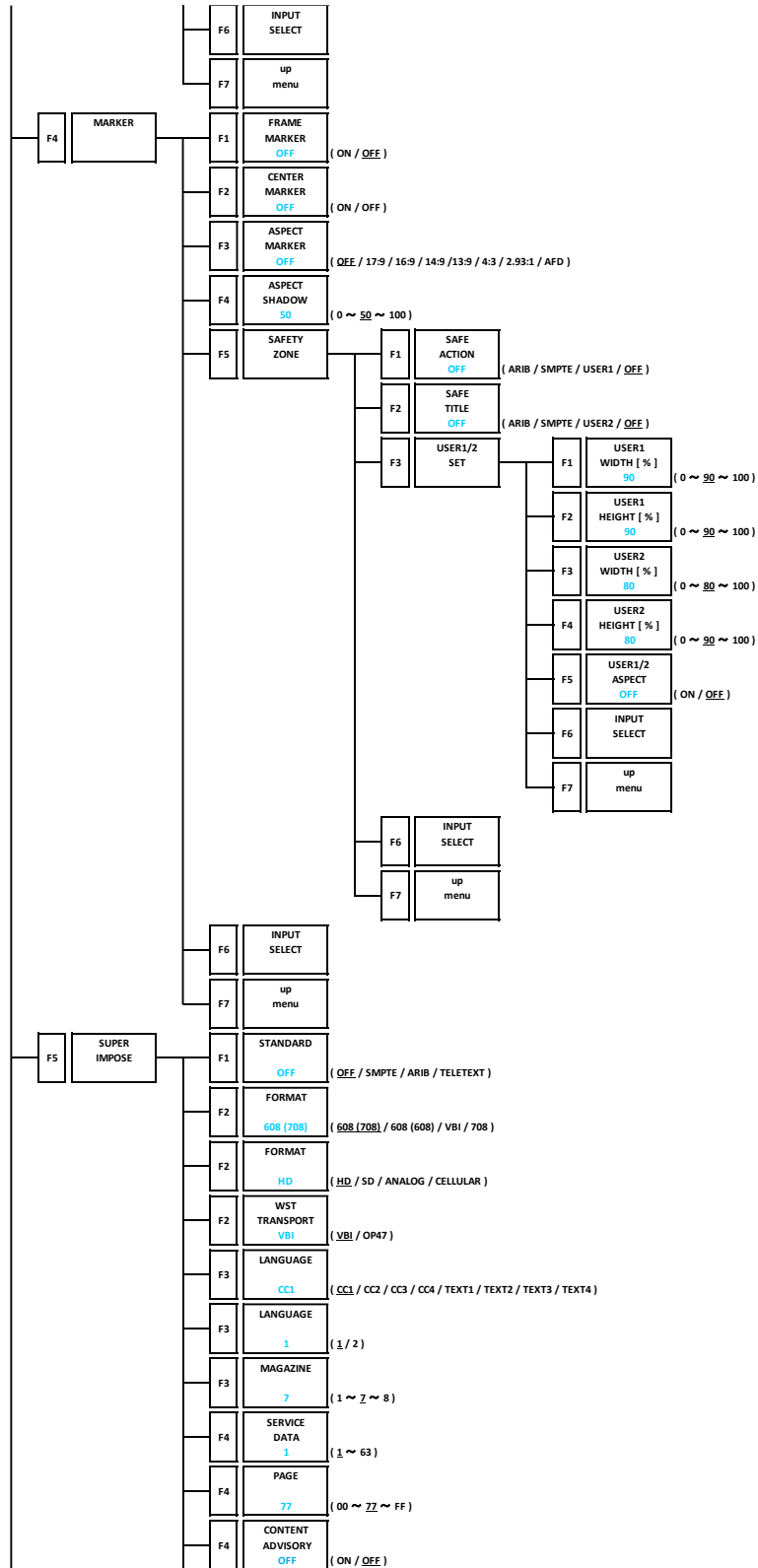

21. MENU TREE

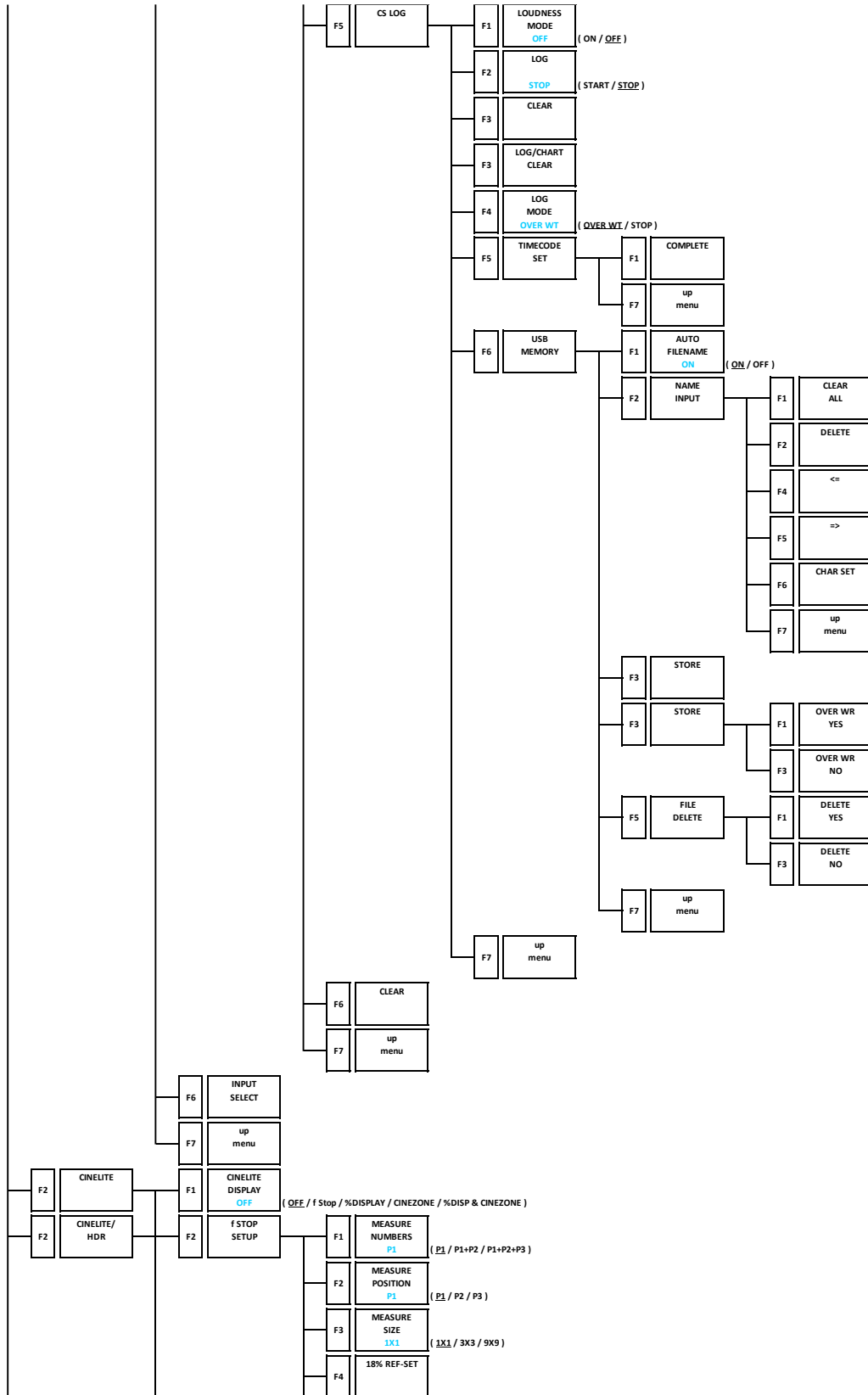

21. MENU TREE

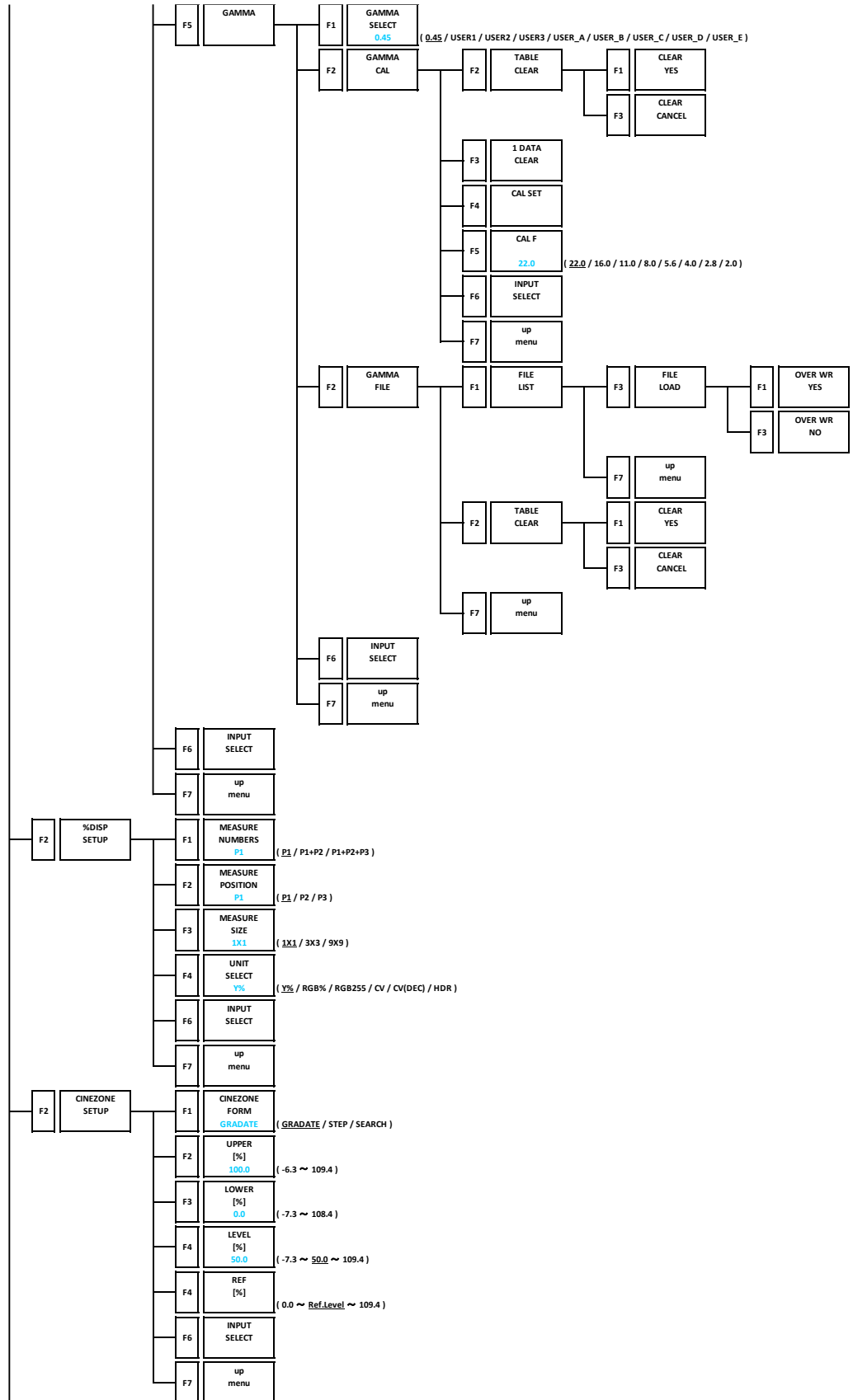

21. MENU TREE

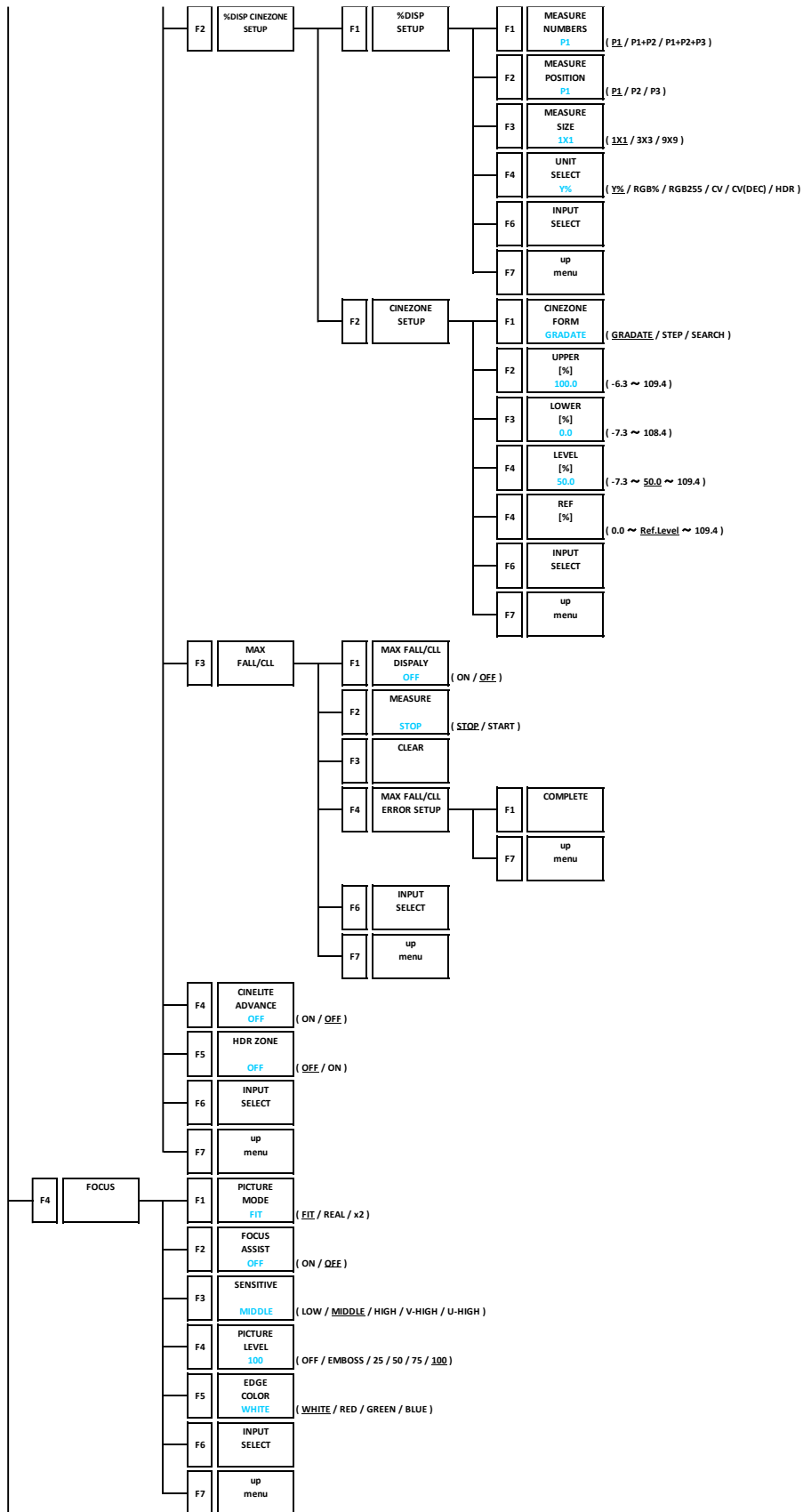

21. MENU TREE

21.9 AUDIO Menu

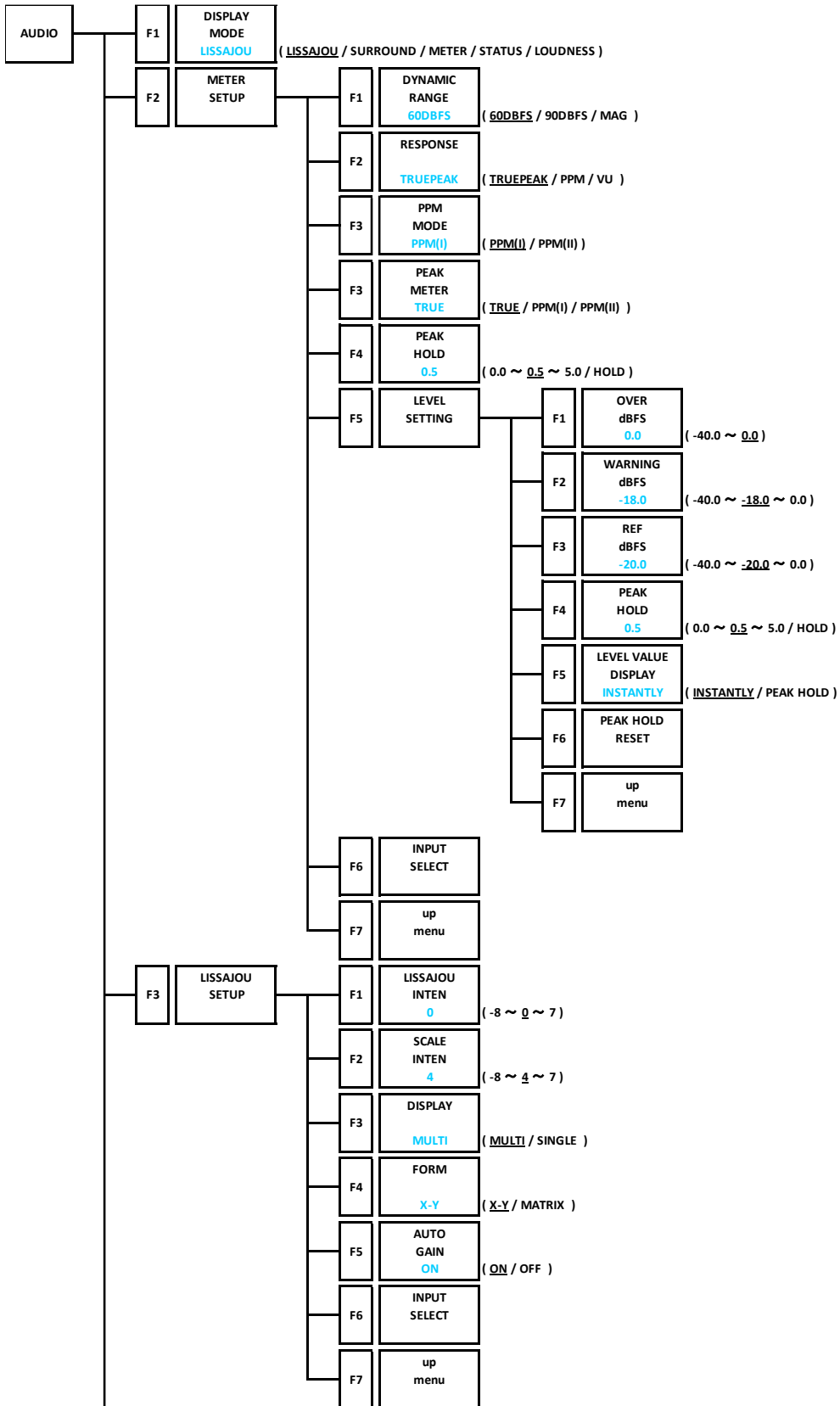

21. MENU TREE

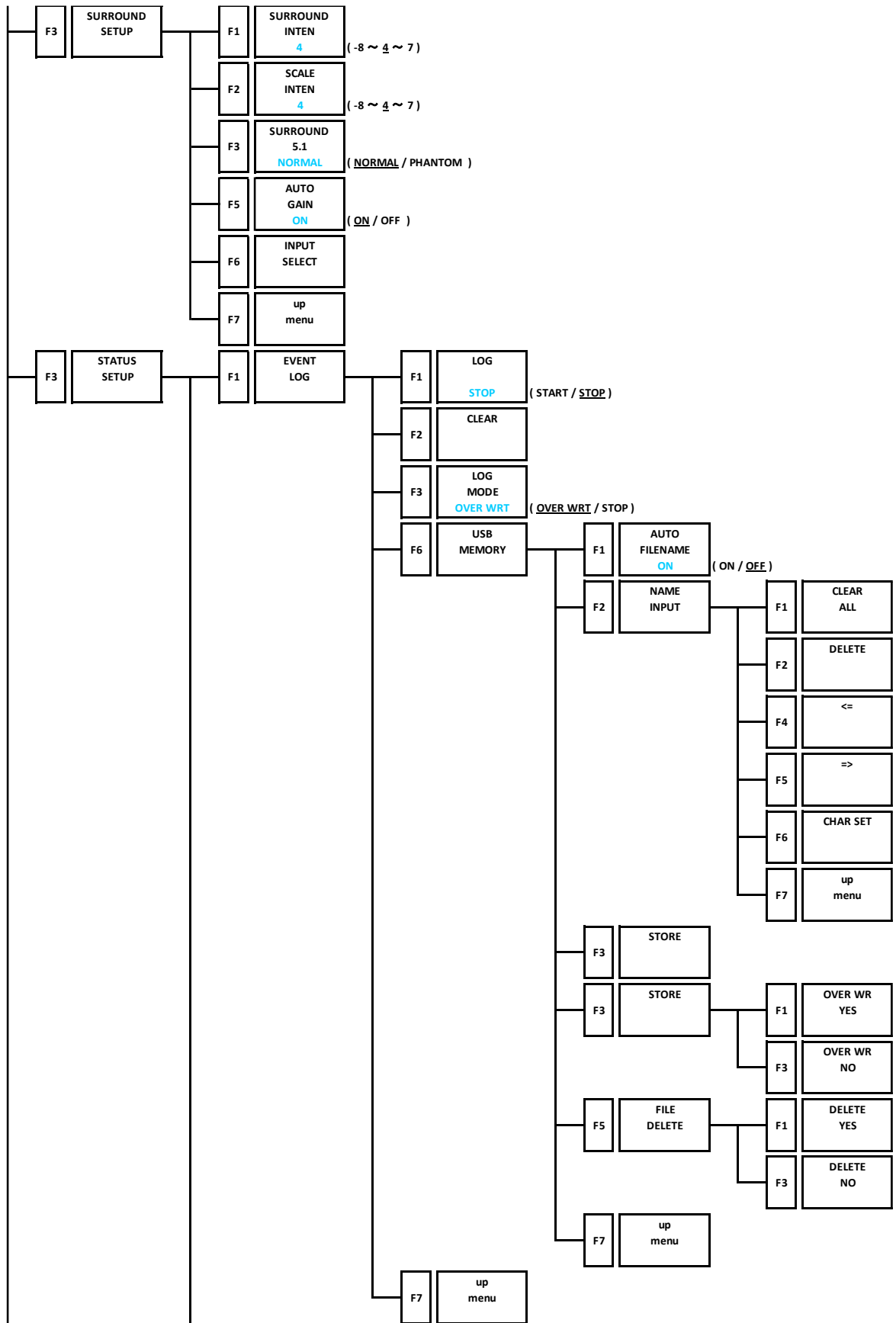

21. MENU TREE

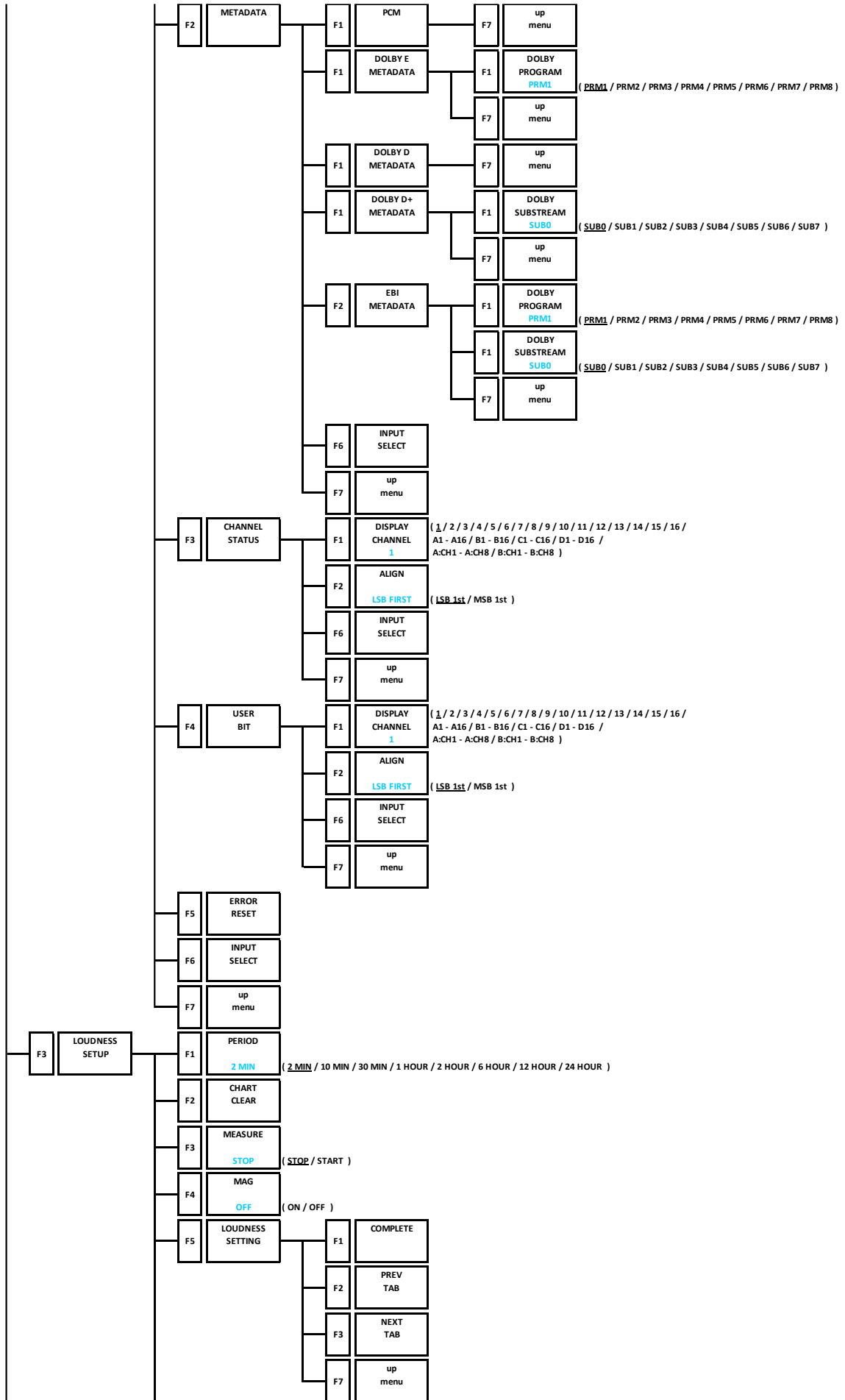

21. MENU TREE

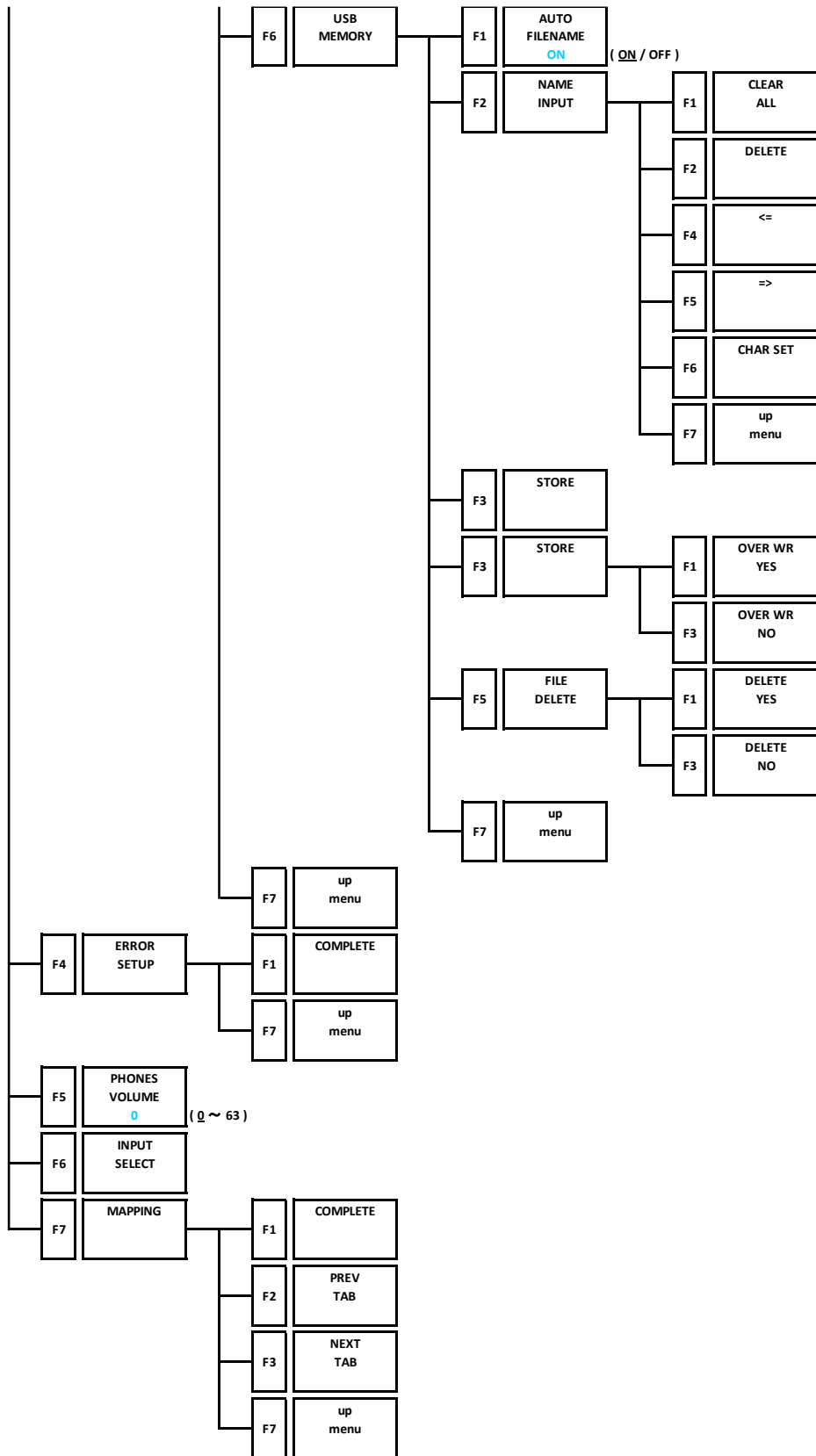

21. MENU TREE

21.10 STATUS Menu

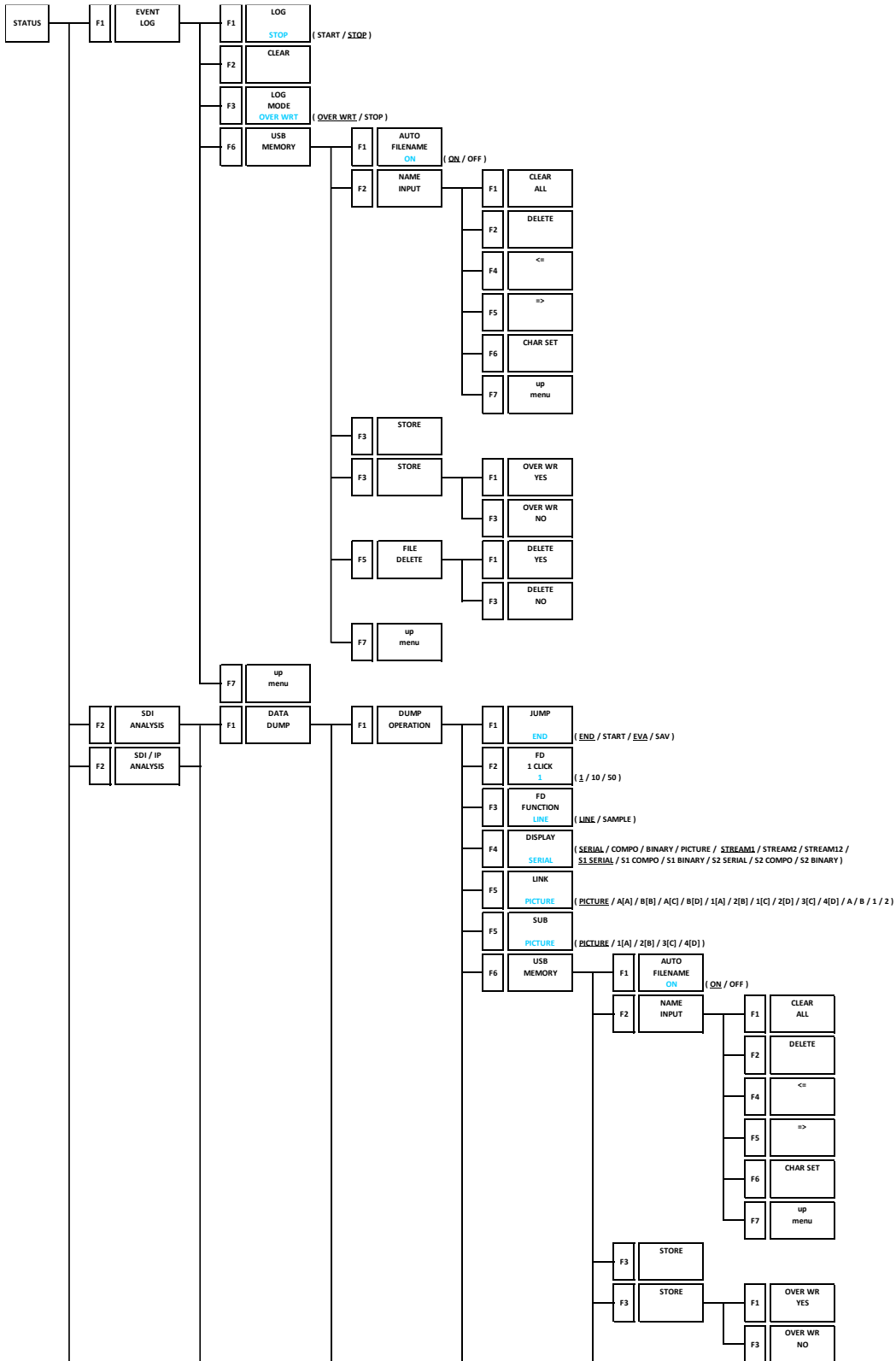

21. MENU TREE

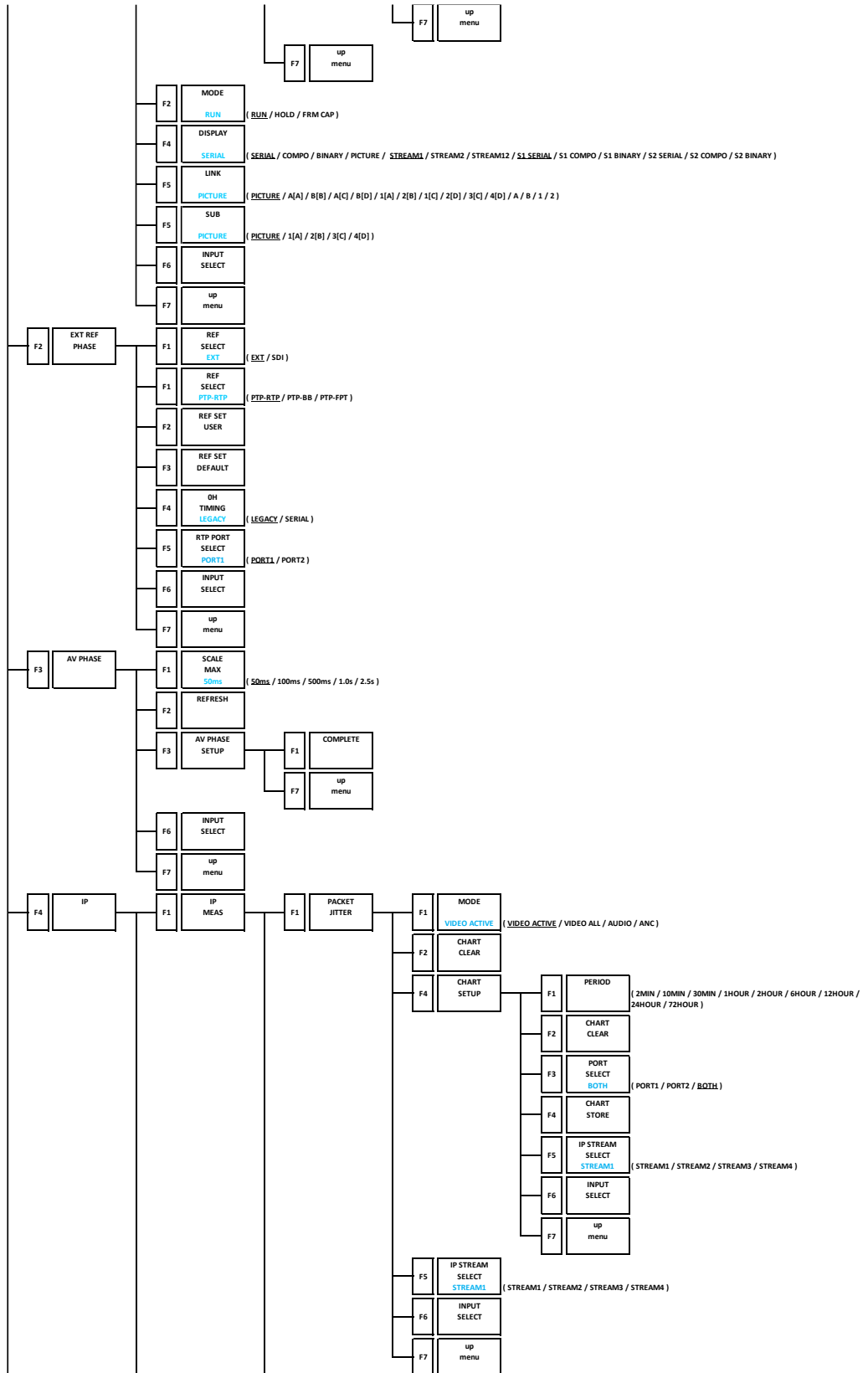

21. MENU TREE

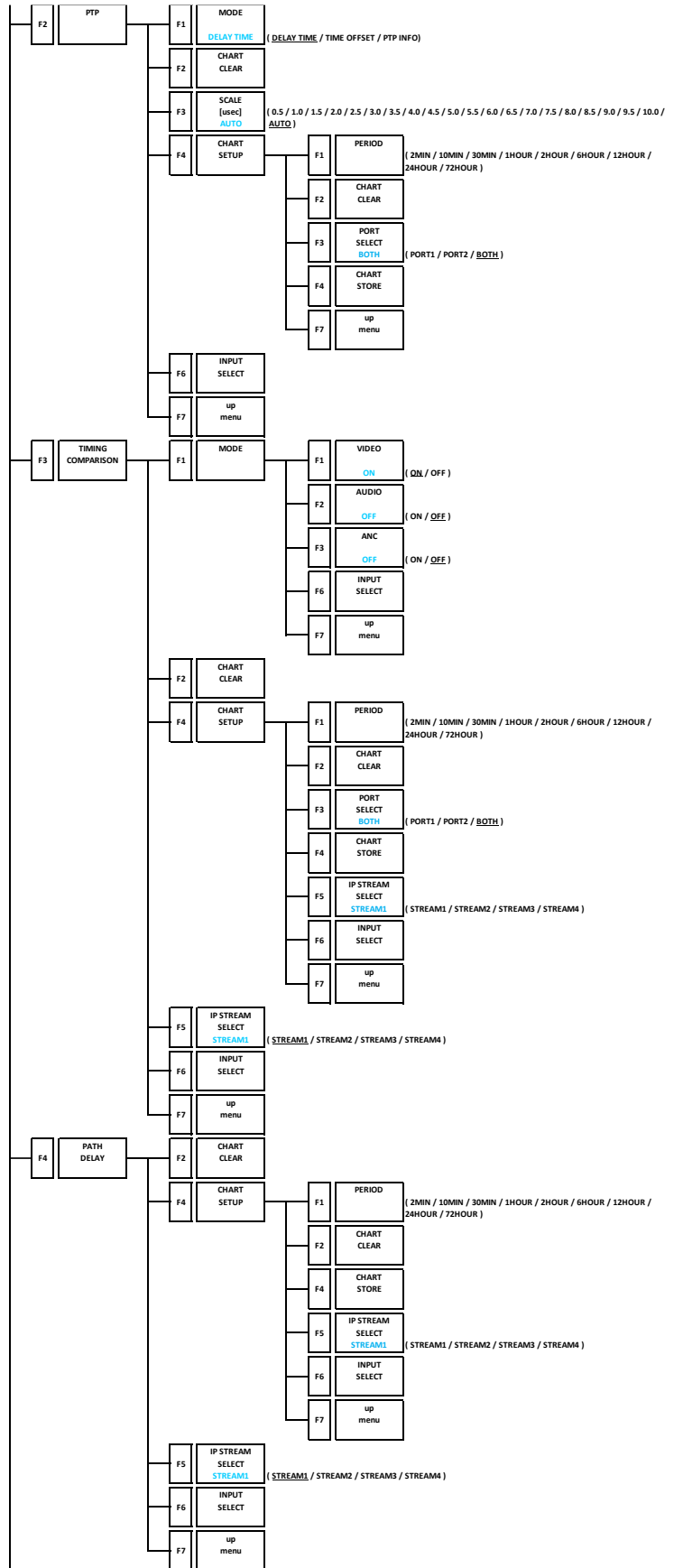

21. MENU TREE

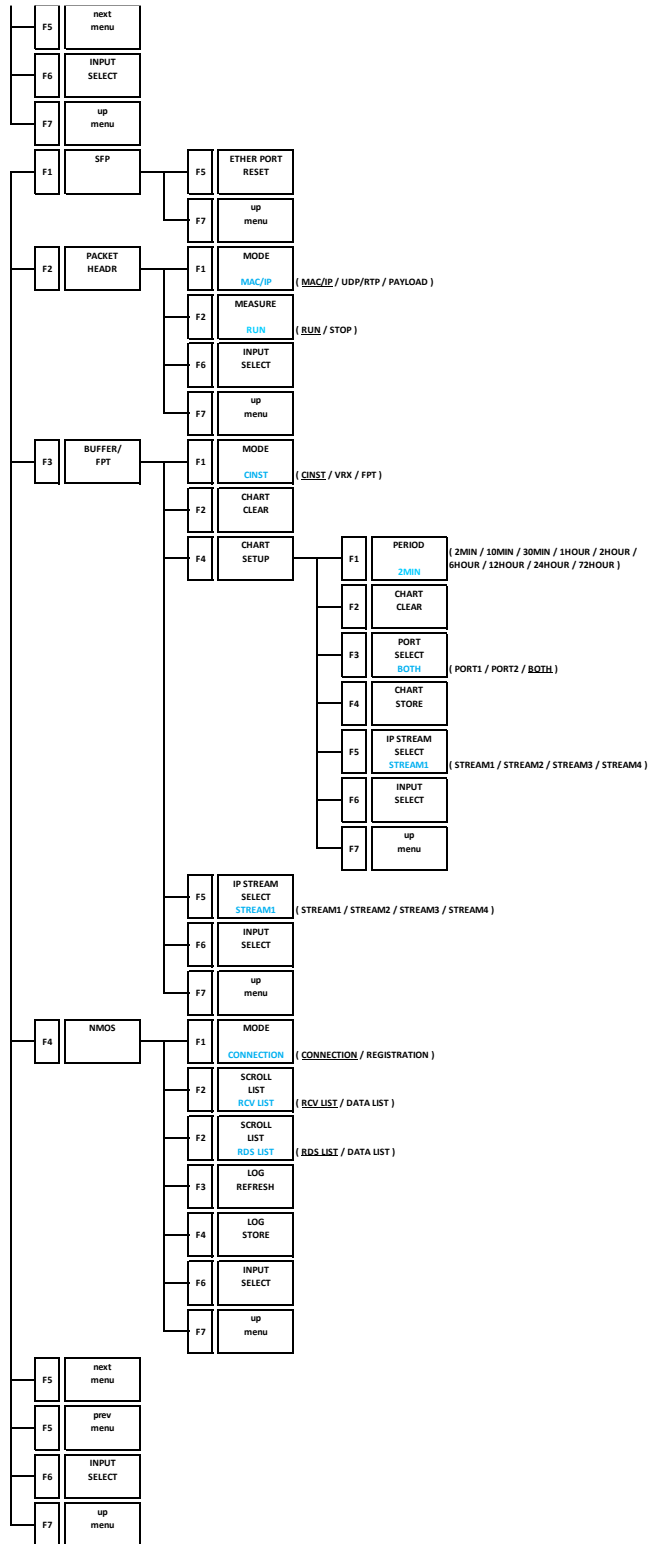

21. MENU TREE

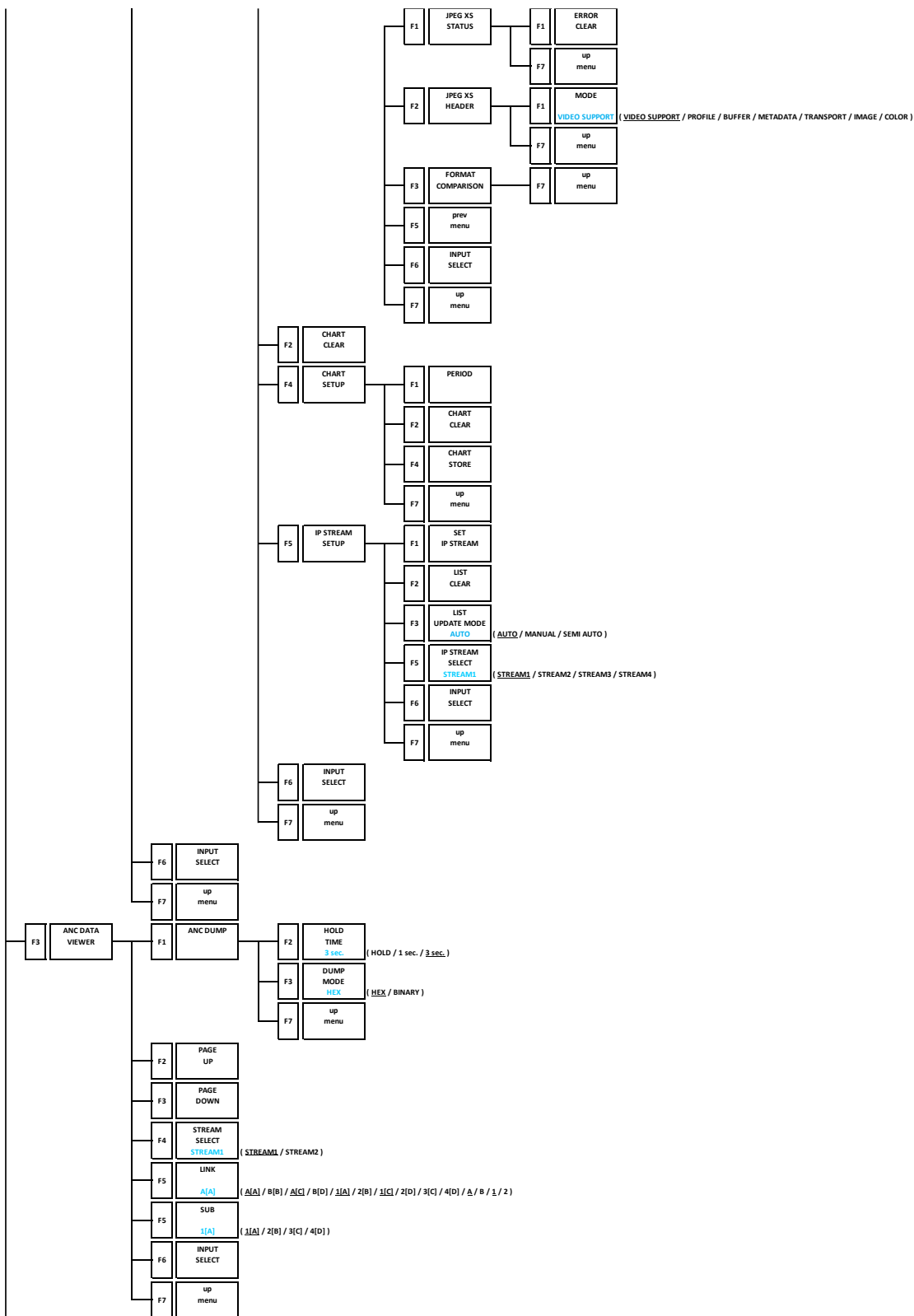

21. MENU TREE

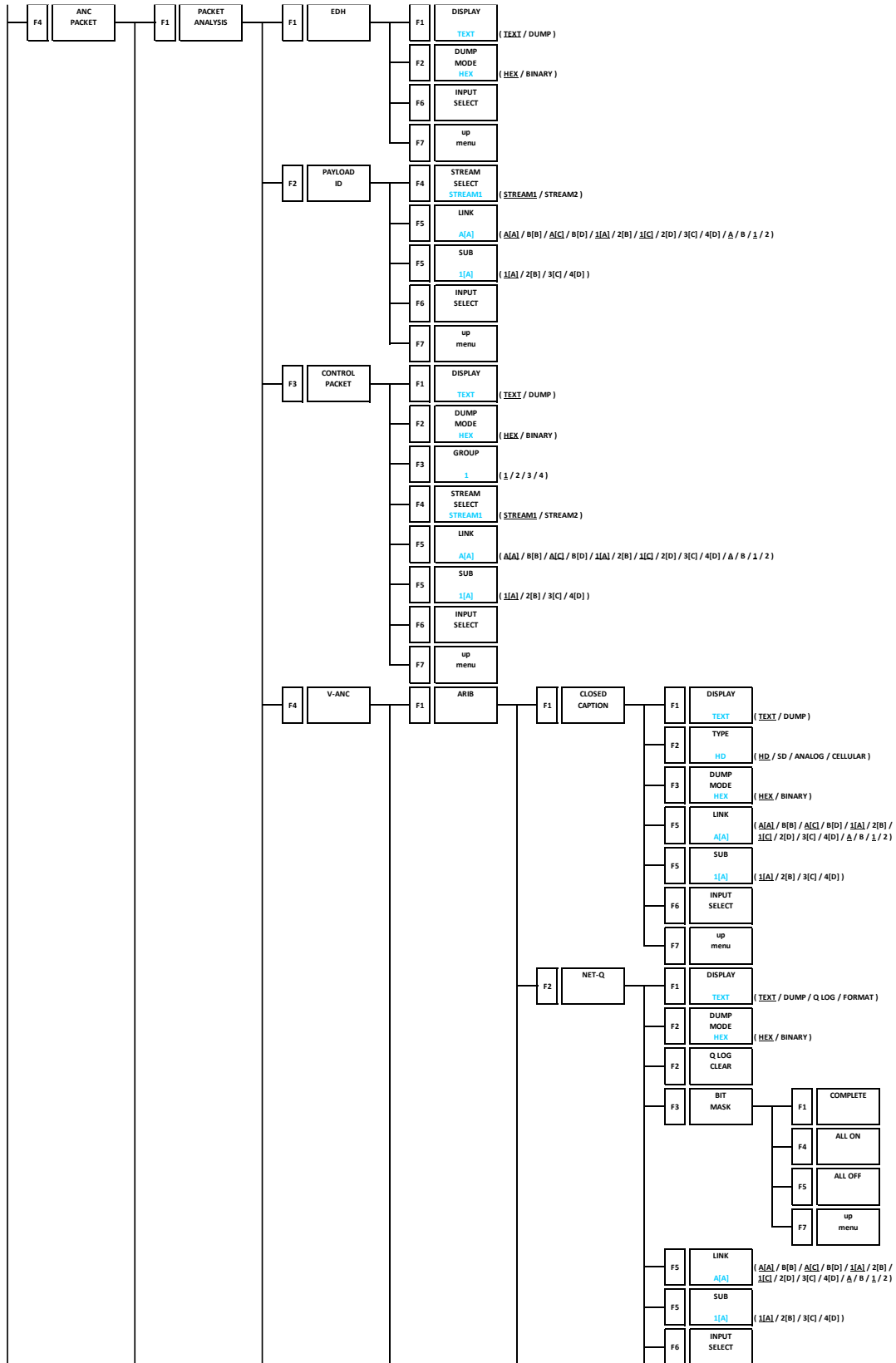

21. MENU TREE

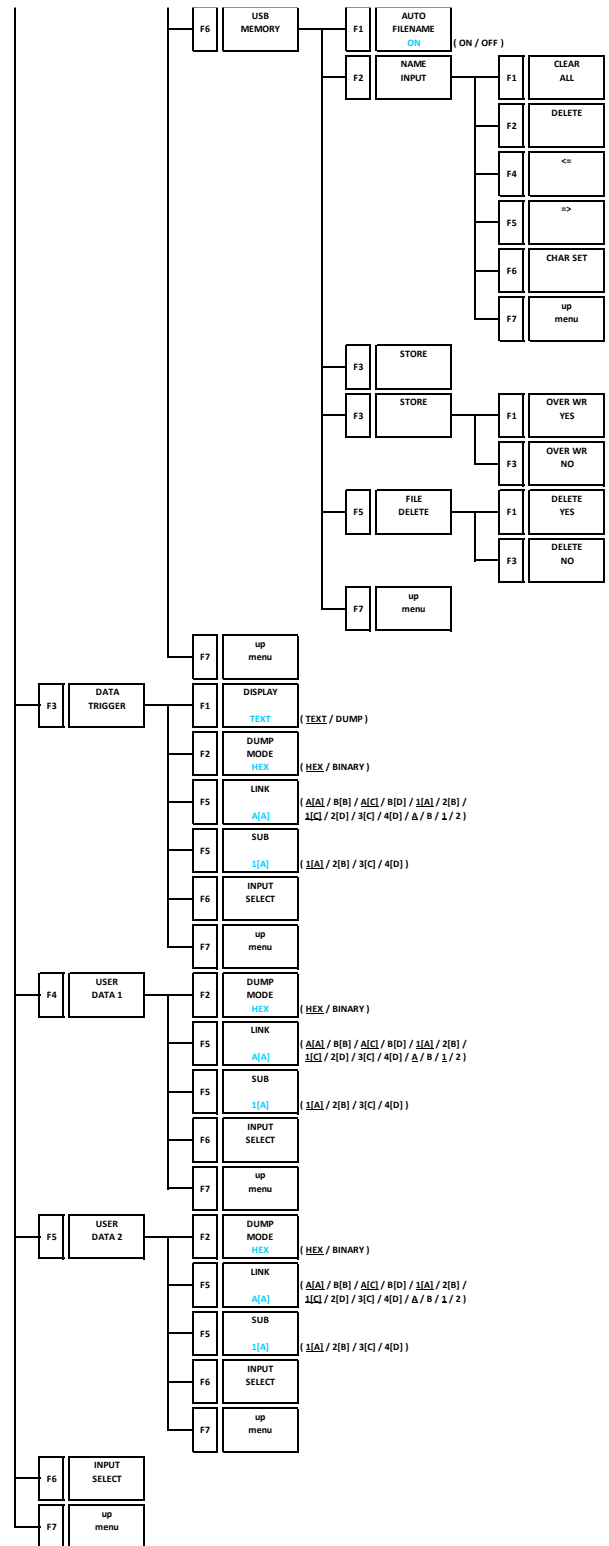

21. MENU TREE

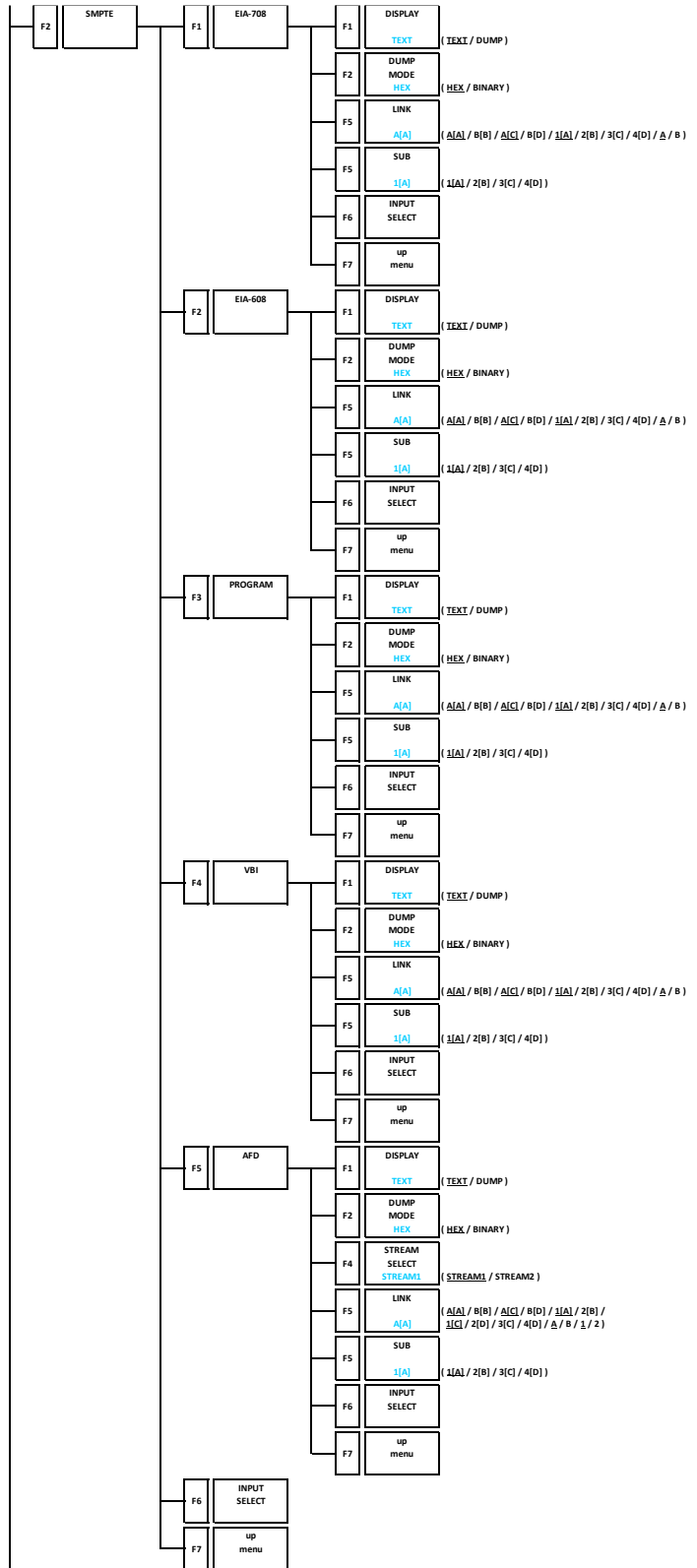

21. MENU TREE

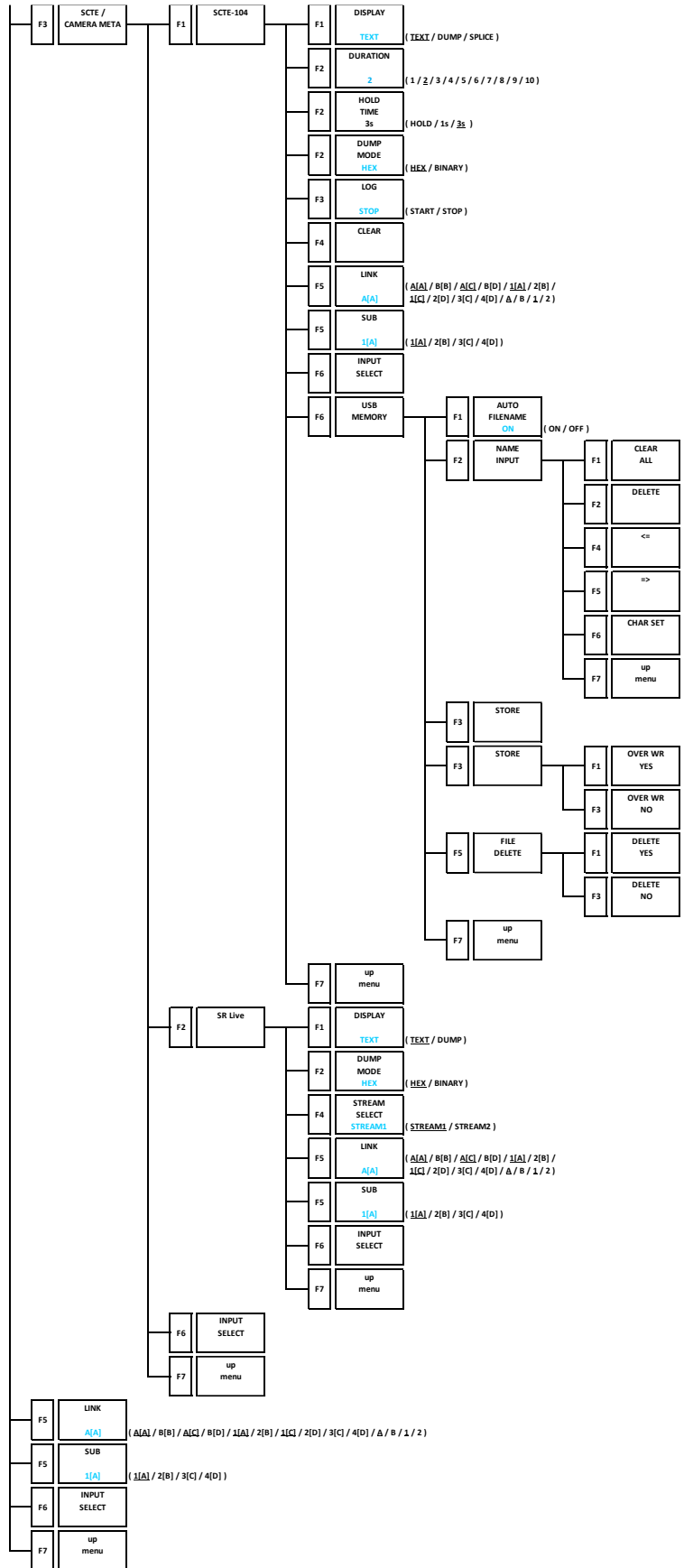

21. MENU TREE

21.11 EYE Menu (SER02/SER02A)

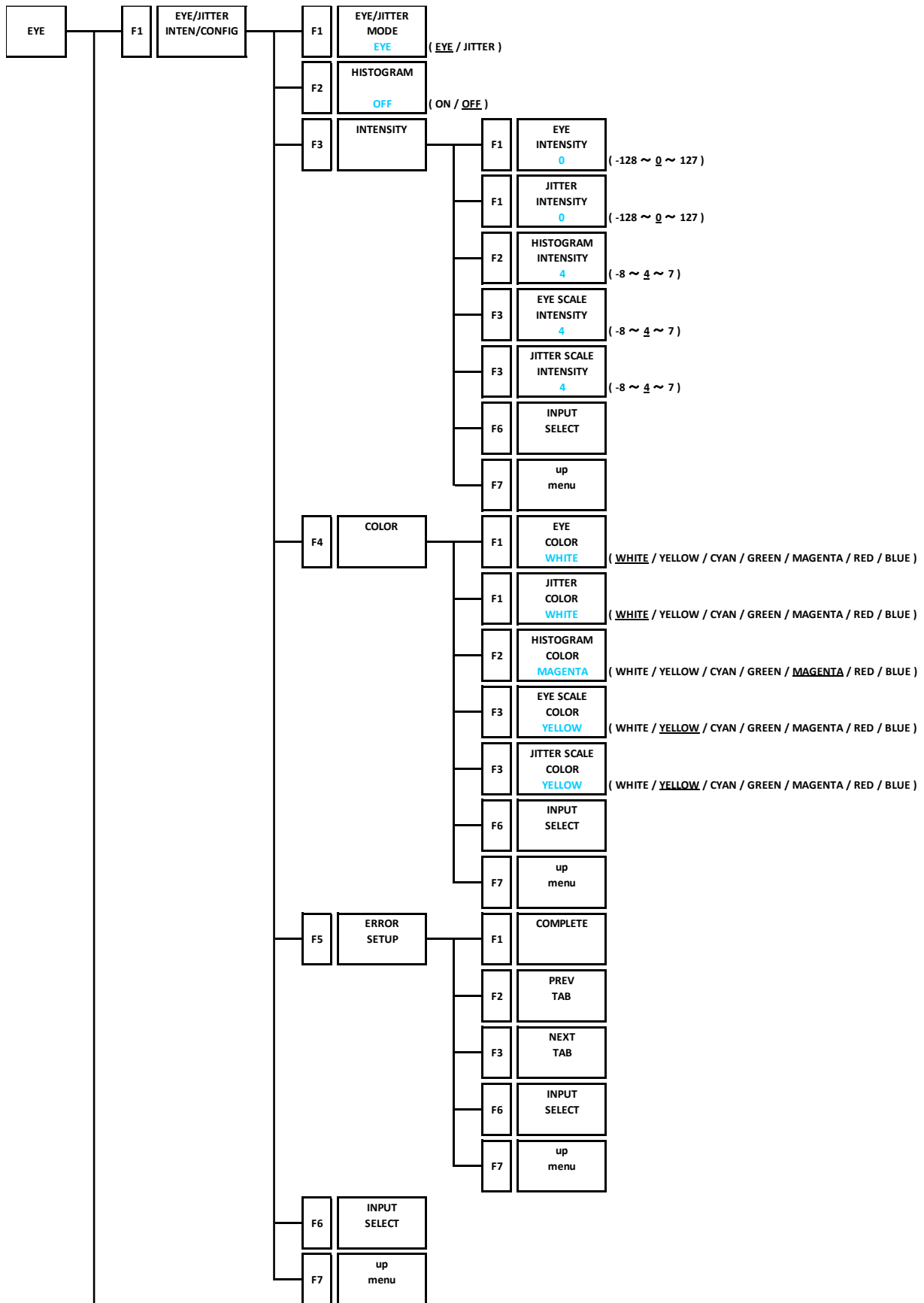

21. MENU TREE

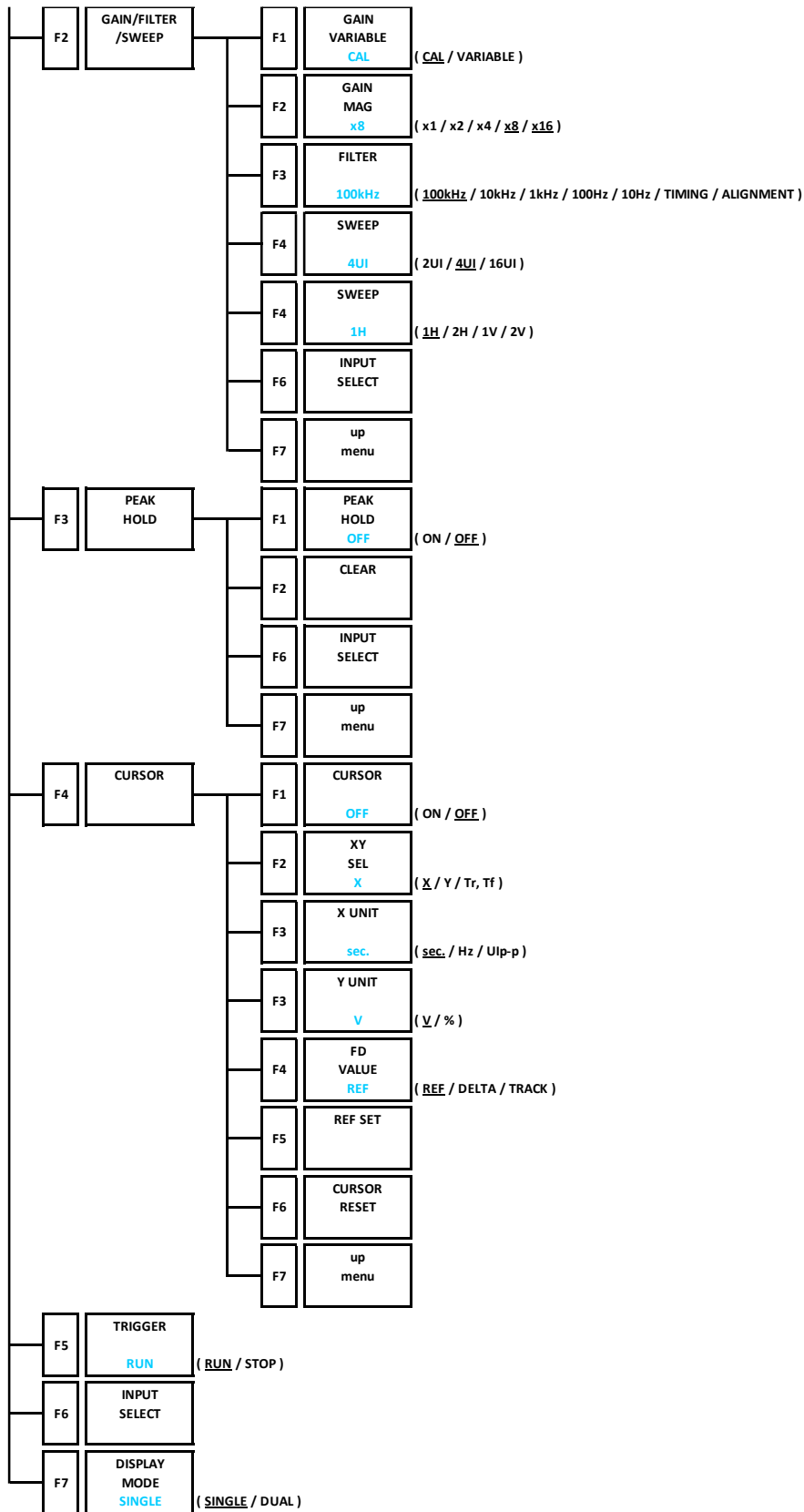

21.12 MULTI Menu

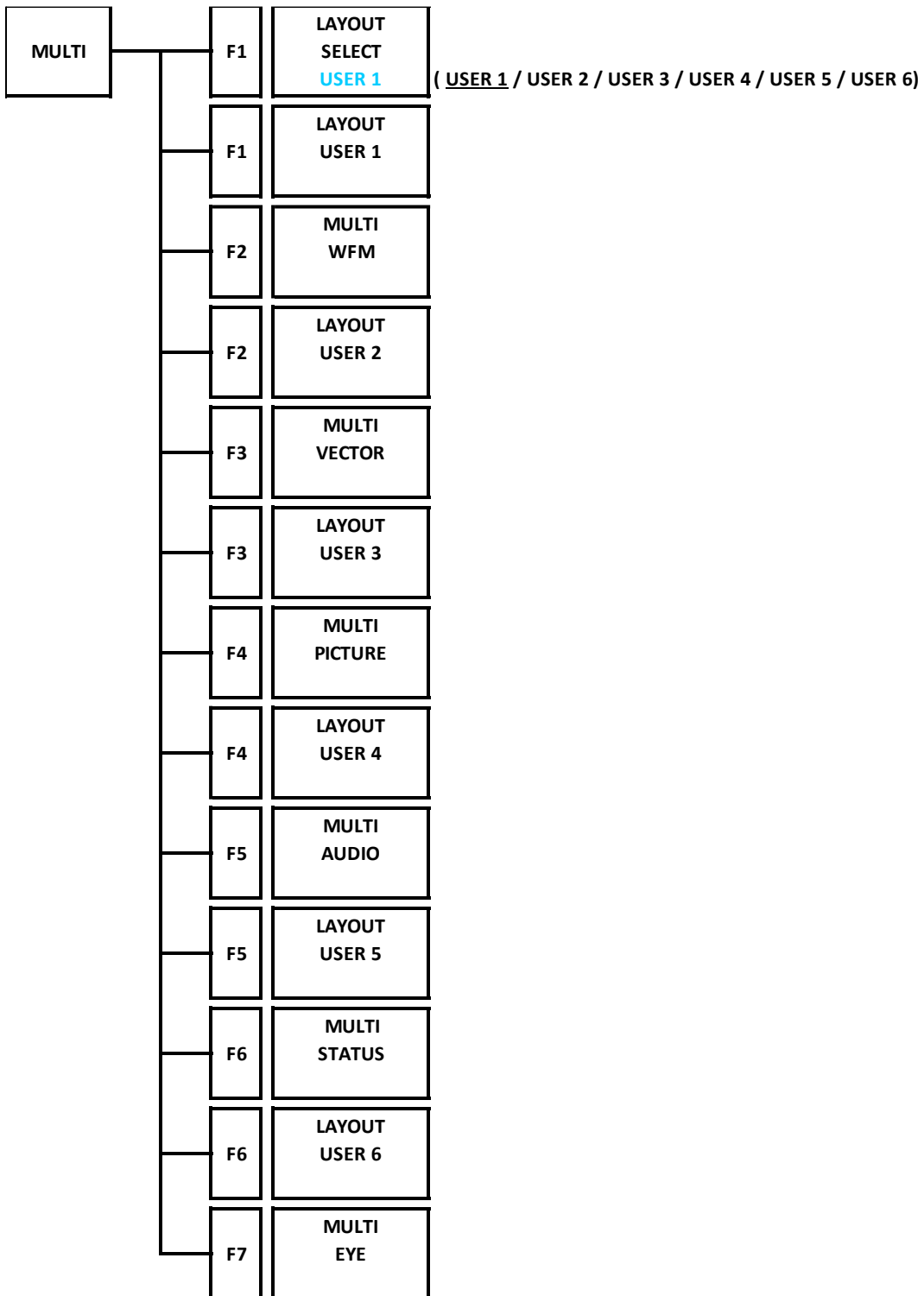

22. FIRMWARE UPDATE HISTORY

This manual is written for firmware version 7.4.

You can view the firmware version by pressing **F•3** SYSTEM INFO on the SYS menu.

- Ver. 7.4
 - [LV5600/LV7600] Fixed IP address setting to loop between 0 and 255.
 - [SER05/SER06] Corrected the display of TimeSource in PTP Info from GPS to GNSS. (Because the notation was changed in the IEEE1588-2019 standard).
 - [SER06] Support for SMPTE ST 2110-30/31 audio channel mapping function.
- Ver. 7.3
 - [LV5600/LV7600] Support for common use of preset data for LV5600 and LV7600.
 - [SER01/SER02/SER02A/SER05/SER06] Added source ID display.
 - [SER01/SER02/SER02A/SER05/SER06] Added timecode continuity monitoring and date and time display.
 - [SER01/SER02/SER02A/SER05/SER06] Multilingual support for closed caption display of pictures.
 - [SER05/SER06] Fixed so that SMPTE ST 2110-40 Payload ID can be obtained from SNMP.
 - [SER06] Added seamless signal switching function using NMOS of SMPTE ST 2110-20.
- Ver. 7.2
 - Minor changes
- Ver. 7.1
 - [SER03] Changed so that the channel order can be switched in Audio Status.
 - [SER05/SER06] Added a mode that ignores the Source Address when receiving a request for signal switching from NMOS (IS-05).
- Ver. 7.0
 - [SER05/SER06] Support for NMOS IS-04 (v.1.3).
 - [SER33] Added JPEG XS support option.
- Ver. 6.9
 - [SER32] Added a function to superimpose arbitrary characters on the test pattern generator.
- Ver. 6.8
 - Minor changes
- Ver. 6.7
 - [LV5600/LV7600] Changed Select item of REMOTE setting so that it is not initialized when updating.
 - [SER01/SER02/SER02A/SER05/SER06] Added simultaneous display of CINELITE %DISPLAY and CINEZONE in picture.
 - [SER05/SER06] Improved so that you can select whether to enable or disable the address setting (Src/Dest) of IP SETUP1 as the target of preset recall.
 - [SER05/SER06] Changed the notation to READY (yellow letters) when the PTP offset on the redundant side is 1 μ s or more.
 - [SER05/SER06] Changed to send notification of address change to RDS server of NMOS when IP Address is changed on NETWORK tab of SYSTEM SETUP.

22. FIRMWARE UPDATE HISTORY

- [SER32] Improved so that you can select whether to enable or disable the address setting (Src/Dest) of IP TSG SETUP2 as the target of preset recall.
- Ver. 6.6
 - Minor changes
- Ver. 6.5
 - Minor changes
- Ver. 6.4
 - [SER01/SER02/SER02A/SER05/SER06] Added color bar scale information display to the vector screen.
 - [SER01/SER02/SER02A/SER05/SER06] SR Live Metadata Ver.1.10 in the analysis display of SR Live Metadata on the status screen is now supported.
 - [SER05/SER06] Improved to get SDP file by FTP.
 - [SER23] Added HDR information display to the vector screen.
- Ver. 6.3
 - Minor changes
- Ver. 6.2
 - [LV5600/LV7600] NTP (SNTP) supports all time zones.
 - [SER01/SER02/SER02A/SER05/SER06] Added a remote command to get the maximum and minimum values of Y/R/G/B/CMP by TELNET/SNMP when displaying vector 5BAR.
 - [SER05/SER06] Improved so that IP 1/2 input port that synchronizes with PTP can be switched by BMCA.
 - [SER05/SER06] Added the setting to adjust the time until PTP locks. (Reduces errors by slowing down the time to lock when PTP becomes momentarily unstable.)
 - [SER05/SER06] Added PTP ClockClass event to event log.
 - [SER06] Added PTP-FPT mode in the EXT REF PHASE display when the input is IP signal (SMPTE ST 2110).
- Ver. 6.1
 - [SER01/SER02/SER02A/SER05/SER06] Added color wheel display to the VECT menu.
 - [SER05/SER06] Improved to add the SER05/SER06 serial number on NMOS each node label.
 - [SER05/SER06] Improved so that the dialog can be displayed on the status NMOS screen while the data log are stored to USB flash memories.
- Ver. 6.0
 - [SER06] SMPTE ST 2110-20 3840x2160 / 30P, 29.97P, 25P, 24P, 23.98P reception formats are now Supported.
 - [SER05/SER06] ST 2110-20 / ST 2022-6 1920 x 1080/30PsF,29.97PsF, 25PsF, 24PsF, 23.98PsF reception formats are now Supported.
 - [SER05/SER06] Improved so that when the SMPTE ST2110-40 Payload ID is received, the Payload ID output by SDI and the SMPTE ST 2110-40 Payload ID are displayed at the same time on the PAYLOAD ID display of ANC PACKET.
 - [SER23] Improved to display HDR unit in Nits.
 - [SER32] SMPTE ST 2110-20 3840x2160 / 30P, 29.97P, 25P, 24P, 23.98P transmission

22. FIRMWARE UPDATE HISTORY

formats are now Supported.

- [SER32] ST 2110-20 / ST 2022-6 1920 x 1080/30PsF,29.97PsF, 25PsF, 24PsF, 23.98PsF transmission formats are now Supported.
- Ver. 5.9
 - [SER01/SER02/SER02A/SER05/SER06] Improved to display additional information of "V, S, L, D" in CONTENT ADVISORY display in English closed caption (EIA-608 / 708) display of pictures.
 - [SER06] Added FPT (First Packet Time) measurement function of SMPTE ST 2110-20.
 - [SER06] Added the measurement items specified in SMPTE ST 2110-21 to the BUFFER measurement function of SMPTE ST 2110-20, and improved to display to event logging when the CMAX and VRX Full upper limits are exceeded.
 - [SER05/SER06] Mixed of PTP Communication Mode is now Supported.
 - [SER05/SER06] ST 2110-20 / ST 2022-6 1080/30P, 1080/29.97P, 1080/25P, 1080/24P, 1080/23.98P, 720/30P, 720/29.97P, 720/25P, 720/24P, 720/23.98P reception formats are now Supported
 - [SER05/SER06] Improved to be able to decode even if there is a delay in the RTP time stamp of SMPTE ST 2110-20 / 30 / 40.
 - [SER05/SER06] In the SMPTE ST 2110-20 / 30/40 timing comparison measurement, the RTP timing error threshold is set and improved to display to event logging when the threshold is exceeded.
 - [SER05/SER06] Improved to search the NMOS registration server according to the DNS-SD specification.
 - [SER05/SER06] Improved so that the IP Address, Subnet Mask, and Default Gateway of IP Port1 and Port2 can be changed from the SNMP command.
 - [SER05/SER06] Improved so that IP STREAM SELECT in PACKET JITTER, TIMING COMPARISON, PATH DELAY, BUFFER can be changed from the SNMP command.
 - [SER32] ST 2110-20 / ST 2022-6 1080/30P, 1080/29.97P, 1080/25P, 1080/24P, 1080/23.98P, 720/30P, 720/29.97P, 720/25P, 720/24P, 720/23.98P transmission formats are now Supported.
- Ver. 5.8
 - Minor changes
- Ver.5.7
 - [SER26] Improved so that the NMOS screen can be added from the layout.
 - [SER32] Improved so that the IP TSG function can be registered and controlled (IS-04 / 05) by NMOS.
- Ver.5.6
 - [SER01/SER02/SER02A] Improved so that the splice_request_data of SCTE-104 can be analyzed and displayed and logged in the picture and status.
 - [SER01/SER02/SER02A] Improved the color gamut error in the status so that the event log now shows whether the error is due to the upper threshold or the lower threshold for each of R, G, and B.
 - [SER01/SER02/SER02A] Improved the level error in the status so that the event log now shows whether the error is due to the upper threshold or the lower threshold.

22. FIRMWARE UPDATE HISTORY

- Ver.5.5
 - [SER02A] LV5600-SER02A (SDI INPUT / EYE) is now supported.
 - [SER05/SER06] Added Interval Variation to the event log function.
 - [SER05/SER06] Renamed Loss Stream in the event log to Video RTP Sequence.
- Ver.5.4
 - [SER05/SER06] Improved Hostname of the NMOS so that you can select whether to target the preset recall or not.
- Ver.5.3
 - [SER01/SER02] Improved so that CONTENT ADVISORY can be displayed in English closed caption (EIA-608 / 708) of the picture.
 - [SER05/SER06] DNS-SD of NMOS is now supported.
 - [SER05/SER06] Improved to be able to switch 2K / 4K signals from NMOS.
 - [SER05/SER06] Improved so that the PTP correctionfield can be corrected.
 - [SER05/SER06] The SDI Out PID Insert is improved from ON/OFF settings to ST2110-40 / NMOS (SDP) / Manual selection.
 - [SER05/SER06] Improved so that Port1 / Port2 can be selected in PTP-RTP phase difference measurement.
- Ver.5.2
 - Minor changes
- Ver. 5.1
 - [SER03] Improved so that the AV PHASE measurement values of the status can be acquired by remote command (SNMP / Telnet) to the status.
 - [SER05/SER06] Added the NMOS display function to the status.
 - [SER05/SER06] Improved IGMP Leave / Join to be faster.
 - [SER05/SER06/SER32] Improved so that measurement data acquisition and tab menu settings can be controlled by SNMP commands.
- Ver. 5.0
 - [SER01/SER02] SR Live Metadeta Ver.1.00 in the SR Live Metadeta analysis display is now supported when the status.
 - [SER06] To assign multiple audio signals of SMPTE ST2110-30 to one video signal is now supported.
- Ver. 4.9
 - [LV5600/LV7600] Changed from "REMOTE LABEL INPUT" to "REMOTE LABEL" on the LV7290 tab in SYSTEM SETUP.
 - [SER05/SER06] Improved to make the graph easier to see by using the actually measured Min value as the minimum value of the PACKET JITTER graph.
 - [SER06] Added the RS-FEC function.
- Ver. 4.8
 - Minor changes
- Ver. 4.7
 - [SER01/SER02] Added an SCTE-104 analysis display to the status.

22. FIRMWARE UPDATE HISTORY

- Ver. 4.6
 - [SER01/SER02] Improved to display Spanish and Portuguese in English closed caption (EIA-608/708) to the picture.
 - [SER05/SER06] Added the GM information display function of PTP.
 - [SER05/SER06] Improved so that even if the payload ID is not inserted in the SMPTE ST 2110-40 packet, the payload ID matched the SMPTE ST 2110-20 IP signal can be inserted to the SDI output converted from IP to SDI.
 - [SER05/SER06] Improved to measure both port 1 and port 2 in each the SMPTE ST 2110 measurement functions (PACKET JITTER, PTP STATUS, and TIMING COMPARISON).
 - [SER05/SER06] Improved to record to the event log using the PTP time.
 - [SER05/SER06] Improved to measure AUDIO and ANC in the packet jitter measurement function of SMPTE ST 2110.
 - [SER05/SER06] Improved so that each measurement graph data of SMPTE ST 2110 (IP STATUS, PACKET JITTER, PTP STATUS, TIMING COMPARISON, and PATH DELAY) can be saved to a USB memory device in CSV format.
 - [SER06] Added the buffer measurement function of SMPTE ST 2110-21.
 - [SER23] Improved to record the MAX FALL / MAX CLL error log when the picture.
 - [SER31] LV5600-SER31 and LV7600-SER31 (COLORIMETRY ZONE) are now supported.
 - [SER32] Added the packet error insertion function of SMPTE ST 2110.
 - [SER32] Added the packet jitter insertion function of SMPTE ST 2110.
 - [SER32] Added the lip sync pattern output function of SMPTE ST 2022-6 / SMPTE ST 2110.
- Ver. 4.5
 - Minor changes
- Ver. 4.4
 - Minor changes
- Ver. 4.3
 - Minor changes
- Ver. 4.2
 - [SER05/SER06] PTP-BB phase difference display is now supported.
 - [SER05/SER06] Changed from PTP DIFF to TIMING COMPARISON and from IP JITTER to PACKET JITTER on the layout window notation.
 - [SER06] The PCAP format capture function is now supported.
 - [SER06] SMPTE ST2022-6 is now supported.
 - [SER06] NMOS (IS-04/05) is now supported.
- Ver. 4.1
 - Minor changes
- Ver. 4.0
 - Minor changes
- Ver. 3.9
 - [SER01/SER02] Added an SR Live analysis display to the status.
 - [SER01/SER02] Added the marker display supported the BT.709 color bar of the color gamut of ARIB STD-B66 and ARIB STD-B72 to the vector. (When VARIABLE SCALE is set to

22. FIRMWARE UPDATE HISTORY

- on and the color gamut is detected as BT.2020, this is valid.)
- [SER01/SER02] English closed caption (EIA 708/608) now supports 4K-6G system.
- [SER06] Added the IGMP version setting menu.
- [SER06] Added the SFP reset menu.
- Ver. 3.8
 - [SER06] The signal output (SER32) from 25G single mode SFP is now supported.
- Ver. 3.7
 - Minor changes
- Ver. 3.6
 - [LV5600/LV7600] Improved so that the assigned address is displayed when DHCP is selected on the SYSTEM SETUP NETWORK tab menu.
 - [SER01/SER02] English closed caption (EIA-608) now supports multiple formats. (HD Dual Link, 3G-A, 3G-B-DL, 4K Dual Link, 4K Quad Link, 12G)
- Ver. 3.5
 - [SER06] LV5600-SER06 and LV7600-SER06 (25G IP INPUT) are now supported.
 - [SER32] LV5600-SER32 and LV7600-SER32 (25G IP TSG) are now supported.
- Ver. 3.3
 - [LV5600/LV7600] Added DDR3 and scaler initialization because, in rare cases, the measurement screen did not appear after startup.
 - [SER01/SER02] Improved so that, on the external sync waveform display, the input signal format displays the same format as that on the EXT REF PHASE screen.
 - [SER01/SER02] Fix a problem that was causing a TRS error and line number error to occur in rare cases after SDI signal detection.
 - [SER03] Improved so that the display of the peak hold value and the instantaneous value can be switched on the meter display.
 - [SER05] Custom layout now supports PATH DELAY and TIMING COMPARISON.
 - [SER05] TELNET and SNMP are now supported.
 - [SER05] IGMPv3-SSM (source specific join) is now supported.
 - [SER05] Fixed so that NMOS control is reflected faster.
- Ver. 3.0
 - [LV5600/LV7600] Improved so that 1080/48P and 1080/47.95P can be selected for MONITOR OUT.
 - [SER01/SER02] For AV PHASE of status, the AV PHASE SETUP menu was changed from F6 to F3, and the INPUT SELECT menu was added to F6.
 - [SER05] For ST2110 signal input, error detection now supports Freeze, Black, Gamut, and Level Y/C.
 - [SER05] The receive buffer for ST2110 signals was expanded to accommodate large fluctuations in the packet intervals.
 - [SER05] For ST2110 signals, support for redundancy including PTP was added.
 - [SER26] Custom layout now supports AV PHASE.
- Ver. 2.8
 - [LV5600/LV7600] Improved so that the waveform color can be specified when the capture is

22. FIRMWARE UPDATE HISTORY

held.

- [SER01/SER02] External sync signal waveform display is now supported on the 4K system.
 - [SER01/SER02] Variable scale is now supported for composite signals on the vector waveform display.
 - [SER01/SER02] Marker display is now supported for the guide display on the vector waveform display.
 - [SER01/SER02] Added a white DCI point marker on the chromaticity diagram.
 - [SER01/SER02] Improved the visibility by making the marker lines thicker and changing the lines to broken lines on the picture marker display.
 - [SER02] Added a histogram to the eye pattern display.
 - [SER02] EYE/JITTER waveform display is now supported on the 4K 6G system.
 - [SER04] Dolby is now supported.
 - [SER05] ST2110-40 (ancillary data) is now supported.
 - [SER05] Added a phase difference graph display function that shows the video, audio, and ancillary signals relative to the PTP.
 - [SER05] Added a PTP packet capture function.
 - [SER05] Expanded the packet capture function to 1MB.
 - [SER05] Made NMOS (IS-05) compatible with the Evertz system.
 - [SER05] Added a function that saves SDP files received by NMOS (IS-05) to a USB memory device.
 - [SER05] NMOS IS-05 BULK mode is now supported.
 - [SER05] Added a function that saves packets received through ETHERNET (RJ45) to PCAP files in a USB memory device.
 - [SER05] Data dump during ST2110 configuration is now supported.
 - [SER05] Added a filter function based on the VLAN ID.
 - [SER23] Added a mode that synchronizes to the payload ID for SDR, HLG, and PQ.
 - [SER27] The TSL protocol is now supported.
- Ver. 2.3
 - [LV5600/LV7600] Added the HTTP server access port (port number 8080) display on the NETWORK tab.
 - [SER01/SER02] Added the variable scale function to the vector waveform display.
 - [SER01/SER02] Added hexadecimal format display on the payload ID screen of the status display.
 - [SER05] NMOS IS-04 Registered Discovery is now supported.
 - [SER05] Added a function to NMOS IS-05 for changing a portion of the settings using SDP files.
 - [SER05] Added a packet capture function.
 - [SER05] Added an ST2022-6 inter-port delay graph display function (PATH DELAY).
 - [SER05] Wide signals defined in ST2110-21 are now supported.
 - [SER05] Added a PTP and ST2110-20 phase display function.
 - [SER05] Improved to support the 720p format.
 - [SER23] C-Log and Log-C are now supported.
 - [SER24] Add the HDR color bar (when SER23 is enabled).
 - [SER29] 6G-SDI system is now supported.
 - Ver. 2.0
 - [LV5600/LV7600] Network control functions (Telnet, FTP, SNMP, Web server, LV7290) are

22. FIRMWARE UPDATE HISTORY

now supported.

- [LV5600/LV7600] Reduced the time until the start logo appears after power-on by 15 to 20 seconds.
 - [SER01/SER02] The frame capture function supports 16 frames for manual mode and error triggers.
 - [SER01/SER02] External sync signal waveform display is now supported.
 - [SER01/SER02] XYZ color matrix signals are now supported.
 - [SER01/SER02] English and European closed captions are now supported.
 - [SER01/SER02] Japanese closed captions are now supported for 4K systems.
 - [SER01/SER02] NET-Q is now supported for 4K systems.
 - [SER03] Loudness is now supported.
 - [SER05] Added an IP packet header analysis display.
 - [SER05] IP event log is now supported.
 - [SER05] NMOS (IS-04) is now supported.
 - [SER05] Added an SFP information display function.
 - [SER05] ST2110-30 (audio) is now supported.
 - [SER05] Added a message rate setting to PTP Setup on the IP SETUP2 tab.
 - [SER23] Full range is now supported in HLG and PQ modes.
- Ver. 1.4
 - [SER01/SER02] Improved so that HDR can be selected for the V cursor value display on the waveform display when the variable gain function is enabled in HDR mode.
 - [SER01/SER02] Histogram was added to the vectorscope display.
 - [SER01/SER02] Improved so that the individual settings of streams 1 and 2 work for the 3G-B DS system in the waveform color setting of the vector display.
 - [SER01/SER02] Improved so that BT.709 and BT.2020 scale and caption are displayed on the initial chromaticity diagram screen.
 - [SER01/SER02] Improved so that the background of the Japanese closed caption display on the picture is changed from black to transparent in sync with the on/off state of the status information.
 - [SER05] LV5600-SER05 and LV7600-SER05 (10G IP INPUT) are now supported.

所含有毒有害物质信息

部件号码: LV 5600



此标志适用于在中国销售的电子信息产品, 依据2006年2月28日公布的《电子信息产品污染控制管理办法》以及SJ/T11364-2006《电子信息产品污染控制标识要求》, 表示该产品在使用完结后可再利用。数字表示的是环境保护使用期限, 只要遵守与本产品有关的安全和使用上的注意事项, 从制造日算起在数字所表示的年限内, 产品不会产生环境污染和对人体、财产的影响。产品适当使用后报废的方法请遵从电子信息产品的回收、再利用相关法令。详细请咨询各级政府主管部门。

产品中有毒有害物质或元素的名称及含量

部件名称 Parts	有毒有害物质或元素 Hazardous Substances in each Part					
	铅 (Pb)	汞 (Hg)	镉 (Cd)	六价铬 (Cr (VI))	多溴联苯 (PBB)	多溴二苯醚 (PBDE)
实装基板	×	○	○	○	○	○
主体部	×	○	○	○	○	○
液晶显示模组	○	○	○	○	○	○
开关电源	×	○	○	○	○	○
风扇	○	○	○	○	○	○
外筐	×	○	○	○	○	○
线材料一套	×	○	○	○	○	○
附件	×	○	○	○	○	○
包装材	○	○	○	○	○	○
电池	○	○	○	○	○	○
选件						
LV5600-SER01	×	○	○	○	○	○
LV5600-SER02	×	○	○	○	○	○
LV5600-SER03	×	○	○	○	○	○
LV5600-SER04	×	○	○	○	○	○
LV5600-SER05	×	○	○	○	○	○
LV5600-SER06	×	○	○	○	○	○
备注)						
○: 表示该有毒有害物质在该部件所有均质材料中的含量均在SJ/T11363-2006 规定的限量要求以下。						
×: 表示该有毒有害物质或元素至少在该部件的某一均质材料中的含量超出SJ/T11363-2006 标准规定的限量要求。						

所含有毒有害物质信息

部件号码: LV 7600



此标志适用于在中国销售的电子信息产品,依据2006年2月28日公布的《电子信息产品污染控制管理办法》以及SJ/T11364-2006《电子信息产品污染控制标识要求》,表示该产品在使用完结后可再利用。数字表示的是环境保护使用期限,只要遵守与本产品有关的安全和使用上的注意事项,从制造日算起在数字所表示的年限内,产品不会产生环境污染和对人体、财产的影响。产品适当使用后报废的方法请遵从电子信息产品的回收、再利用相关法令。详细请咨询各级政府主管部门。

产品中有毒有害物质或元素的名称及含量

部件名称 Parts	有毒有害物质或元素 Hazardous Substances in each Part					
	铅 (Pb)	汞 (Hg)	镉 (Cd)	六价铬 (Cr (VI))	多溴联苯 (PBB)	多溴二苯醚 (PBDE)
实装基板	×	○	○	○	○	○
主体部	×	○	○	○	○	○
开关电源	×	○	○	○	○	○
风扇	○	○	○	○	○	○
外筐	×	○	○	○	○	○
线材料一套	×	○	○	○	○	○
附件	×	○	○	○	○	○
包装材	○	○	○	○	○	○
电池	○	○	○	○	○	○
选件						
LV7600-SER03	×	○	○	○	○	○
LV7600-SER04	×	○	○	○	○	○
LV7600-SER05	×	○	○	○	○	○
LV7600-SER06	×	○	○	○	○	○
备注)						
○: 表示该有毒有害物质在该部件所有均质材料中的含量均在SJ/T11363-2006 规定的限量要求以下。						
×: 表示该有毒有害物质或元素至少在该部件的某一均质材料中的含量超出SJ/T11363-2006 标准规定的限量要求。						

Leader Electronics Corporation

2-6-33 Tsunashimahigashi, Kohoku-ku, Yokohama-shi,
Kanagawa, 223-8505, Japan
www.leader.co.jp/en

Feb. 21, 2024 Ver. 21 (Firmware Ver. 7.4)