

Leader

SFR-Fit

MTF Measurement Software FS3170

Instruction Manual

Thank you for your purchase.

Please read this instruction manual and the accompanying "For safe use of the product" carefully to ensure safe use of the product.

CONTENTS

1	Introduction	4
1.1	Cautions for Use.....	4
1.2	Trademarks and Licenses	4
2	Specification	5
2.1	Summary	5
2.2	Feature	5
2.3	Standard	6
2.3.1	Operating Environment	6
2.3.2	Function	6
2.3.3	Operating Conditions.....	7
2.3.4	Measurement Items.....	7
3	Preparation.....	8
3.1	System Configuration.....	8
3.2	Setting	9
3.2.1	Installing SFR-Fit	9
3.2.2	Connection of PC and Chart Display	9
3.2.3	Connecting the PC and Camera	9
3.2.4	Camera and Chart Display Placement.....	9
4	Basic Measurements	13
4.1	Measurement in Camera Mode.....	13
4.2	Measurement in File Mode.....	21
5	Description of each Window.....	31
5.1	Main Window	31
5.2	Camera Settings Menu	34
5.3	Measurement Settings Menu.....	37
5.3.1	Measurement Parameters Tab	38
5.3.2	Display Parameters Tab	42
5.3.3	Advanced Settings Tab	45
5.4	Output Settings Menu	48
5.5	Utilities Menu	56
5.5.1	SFR Viewer JSON.....	57
5.5.2	SFR Viewer Archive Image.....	60
5.5.3	Waveform.....	63
5.6	Option Menu	65
5.7	MTF Plot Window	66
5.8	ROI Setting Window	72
5.9	Pop-up Graphs	75

5.9.1	Gamma Graph.....	75
5.9.2	Lumi Scatter Plot.....	78
5.10	Icons	80
6	Troubleshooting	81
6.1	Error Code List.....	82
6.2	Error Causes and how to fix the errors.....	85
6.2.1	Error Code 2201 (Feature point detection error).....	85
6.2.2	Error Code 2601 (Tone response error)	88
6.2.3	If the ROI is Shifted	89
6.2.4	When the Color of the Camera Image is Abnormal	91

1 Introduction

Thank you very much for purchasing a measuring instrument from Leader Electronics Corporation. For safe use of the product, please read this instruction manual to the end before use to ensure that you understand how to use the product properly.

If you are still not sure how to use the product after reading this instruction manual, please contact the head office or the nearest sales office listed on the back cover of the instruction manual.

After reading this instruction manual, please keep it in a safe place so that you can refer to it whenever necessary.

1.1 Cautions for Use

1. The copyright of the software belongs to Leader Electronics Corp.
2. You may not decompile, disassemble, decipher, excerpt, or otherwise reverse engineer the software.
3. The software may not be reproduced, modified, distributed to third parties, or used for commercial purposes (rental, pseudo-rental, sale to third parties, etc.).
4. Software may be improved or changed without prior notice.

1.2 Trademarks and Licenses

All company names and product names are trademarks or registered trademarks of their respective companies.

2 Specification

2.1 Summary

SFR-Fit is software for measuring the spatial frequency response (SFR) of cameras used in the automotive, security, and medical industries. It enables measurement with good reproducibility in image processing such as edge enhancement, which is difficult with conventional slanted edge and Siemens stars, and in distorted images such as those from fisheye lenses.

2.2 Feature

- **SFR measurement by contrast method**

The sine-wave contrast method is less susceptible to image noise and offers excellent reproducibility.

- **Automatic generation of chart patterns**

A test chart suitable for the sine-wave contrast method is generated for each measurement, allowing the test chart to be freely positioned relative to the camera. It can also handle images with special distortions caused by fisheye lenses or image processing.

- **Smaller measurement area**

The test chart can be switched by spatial frequency, and the smaller measurement area (ROI) allows for partial measurements.

- **Automatic generation of chart patterns**

This product uses a display for displaying test charts (hereinafter referred to as "chart display").

2.3 Standard

2.3.1 Operating Environment

Operating system	Windows 10 64-bit version (Version 1803 or later)
Processor	
Smallest	Intel or ADMX86-64 processor
Recommendation	Intel or ADMX86-64 processor supporting four logical cores and the AVX2 instruction set
Disc (SSD recommended)	
Amount of space	8GB or more
RAM	16GB or more
Display	
For Applications	Resolution XGA or higher
For Charts	Non-glare type Resolution XGA or higher Contrast 1000:1 or higher (Recommended display: EIZO EV2480-BK)

2.3.2 Function

Test chart generation function	Generates step and bar charts from checker charts captured by camera and displays on chart display.
Measuring Functions	Measure spatial frequency response and MTF from camera-captured images
Other Functions	
Display of incidental measurement results	Display of sampling waveforms in grayscale graphs and bar charts
File input-output	Saving and reading camera setting files and measurement setting files, saving measurement data
Setting Camera Properties	Brightness, Saturation, and other settings (*1)
Supported Camera Devices	
GenICam GenTL	Omron Sentech, Basler
OS Generic Video Interface	USB camera
Supported image input boards	Net Vision SVM-03

*1 The type of property depends on the camera.

2.3.3 Operating Conditions

Measurement environment	The lighting environment and background pattern must be such that no white-out or black-out occurs on the chart display. No lighting reflections on the chart display.
Working distance	Distance where the resolution (*1) of the chart display is in the range of 3 to 10 times the resolution (*1) of the camera
Chart display angle	Must be squarely oriented to the camera within $\pm 10^\circ$.
Chart generation function	The feature points of the checker chart should be clearly visible in the camera capture image. Absence of patterns in the background of the chart display that resemble the feature points of a checker chart.

*1 picture height resolution

2.3.4 Measurement Items

Spatial frequency response	
Measurement details	Graphical display of spatial frequency response with contrast measurement using sine wave bar chart
Measuring range	0.05~1.0 Cycle/Pixel
Number of measurement points	Max. 20 points
Unit of measurement	Cycle/Pixel / LW/PH / LP/mm
MTF	
Measurement details	Calculate spatial frequencies of MTF50, MTF30, MTF20, and MTF10 from spatial frequency response graph by interpolation
Unit of measurement	Cycle/Pixel / LW/PH / LP/mm
Contrast at specified frequency	
Measurement details	Calculated by interpolating the contrast at the specified frequency from the spatial frequency response graph

3 Preparation

3.1 System Configuration

This system performs measurements according to the following procedure.

- 1 The PC (SFR-Fit) generates test charts and displays it on the chart display(s).
- 2 The camera takes pictures of the test charts on the chart display(s).
- 3 The PC (SFR-Fit) does acquisition the image of the camera and measures it.

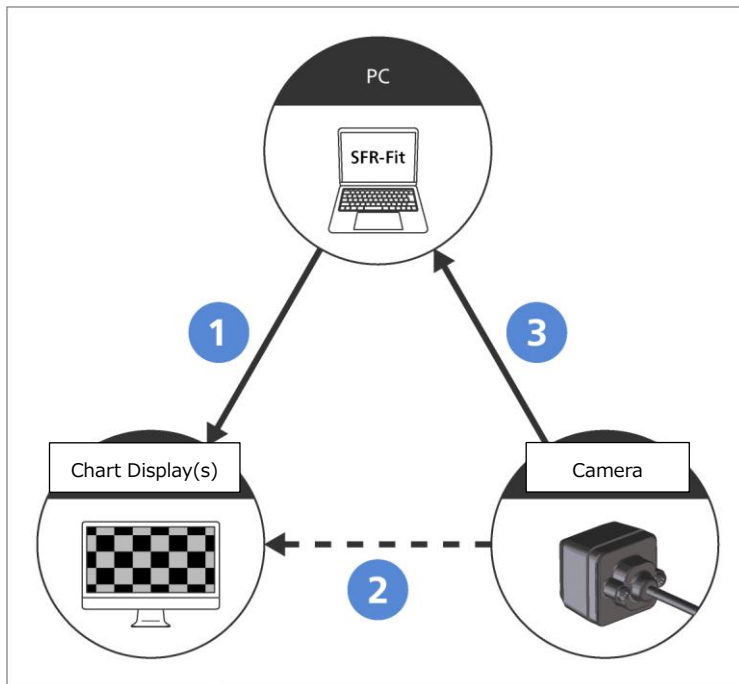

Figure 3-1 | System Configuration

The following three items are required for the measurement.

- **PC**
Install and use SFR-Fit.
Refer to "2.3.1 Operating Environment" and prepare a compatible PC.
- **Chart Display(s)**
A display to show test charts, which must be separate from the PC display.
Prepare a non-glare one with a contrast of 1000:1 or better. Set the luminance to 100% and turn off the automatic brightness adjustment function.
The recommended display is the EIZO EV2480-BK.
Both Auto EcoView and EcoView Optimizer should be turned off.
- **Camera**
The Display Parameters tab is used to set the display to be used as a chart display.

3.2 Setting

3.2.1 Installing SFR-Fit

Install SFR-Fit on your PC.

Refer to the Installation Manual for details.

3.2.2 Connection of PC and Chart Display

Connect chart displays to a PC. Up to 9 chart displays can be connected.

The chart display should be used in extended mode.

3.2.3 Connecting the PC and Camera

Connect the camera to the PC.

Connect a camera that can acquire images directly from SFR-Fit.

If you cannot acquire images directly from SFR-Fit, you can use file mode for measurement.

[Reference] 「5.3.1 Measurement Parameters Tab」

3.2.4 Camera and Chart Display Placement

- **Chart display placement**

To place the chart display in such a way that it does not reflect reflected light from lighting or windows. Use curtains or other means to prevent reflected light.

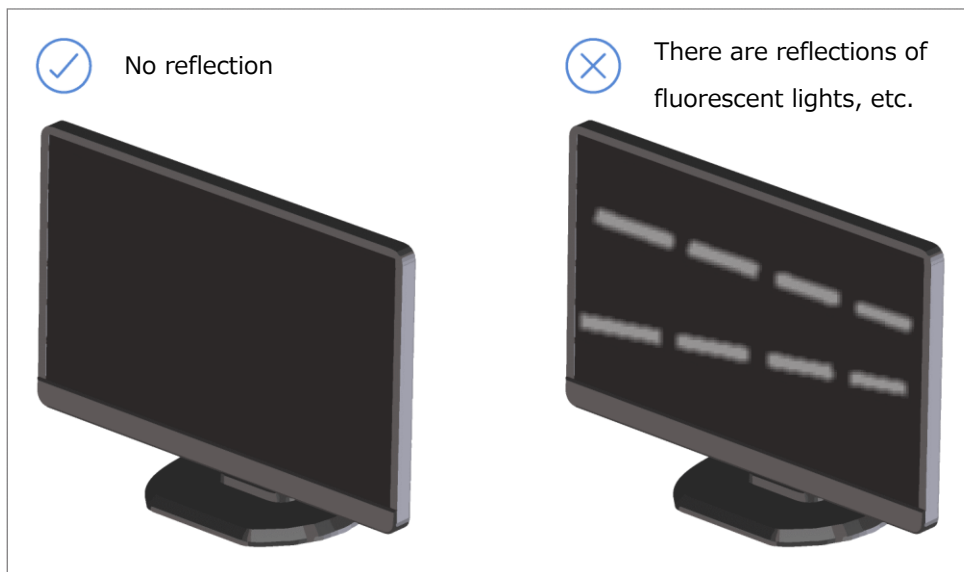

Figure 3-2 | Chart Display Arrangement

Also, the background of the chart display should be a certain brightness. This is because when the camera's Auto Exposure (AE: Auto Exposure) function is enabled, the brightness of the chart changes depending on the brightness of the background of the chart display. Illuminate the 18% gray with the equivalent of a chart display and use this as the background for the chart display.

- **Tilt angle of chart display**

Position the chart display so that it is squarely facing the camera within ± 10 deg of the camera, vertically and horizontally.

If not facing forward, the brightness and contrast of the chart display may be insufficient

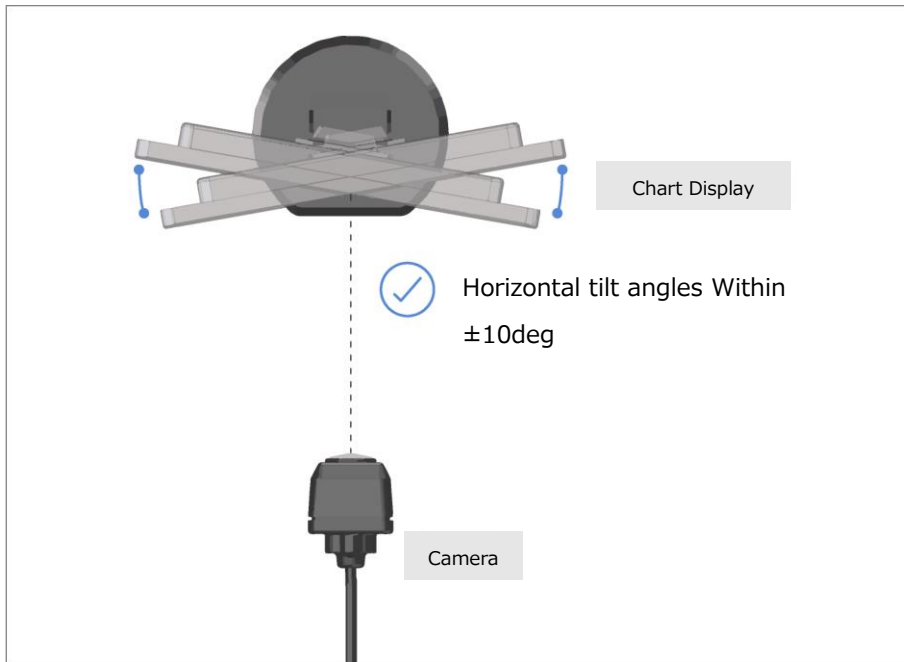

Figure 3-3 | left and right angle

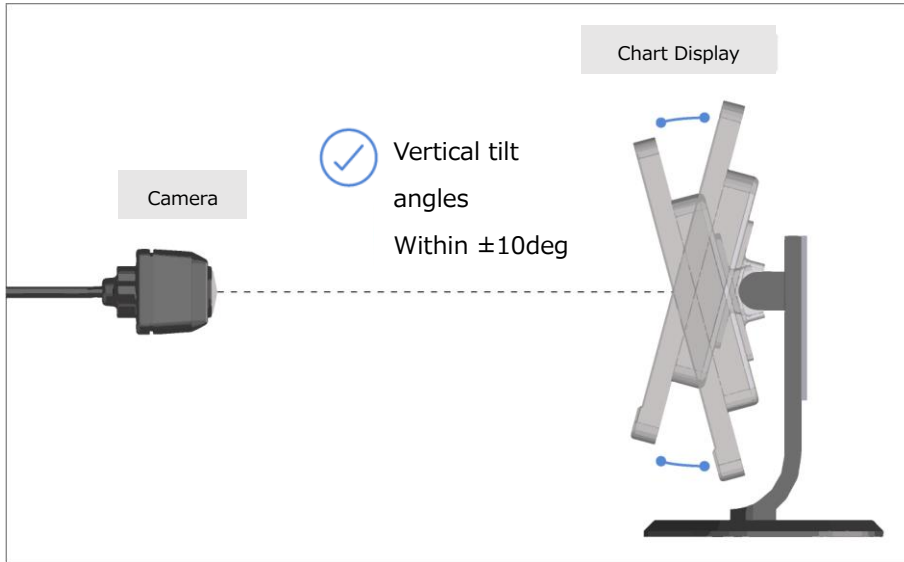

Figure 3-4 | Vertical tilt angle

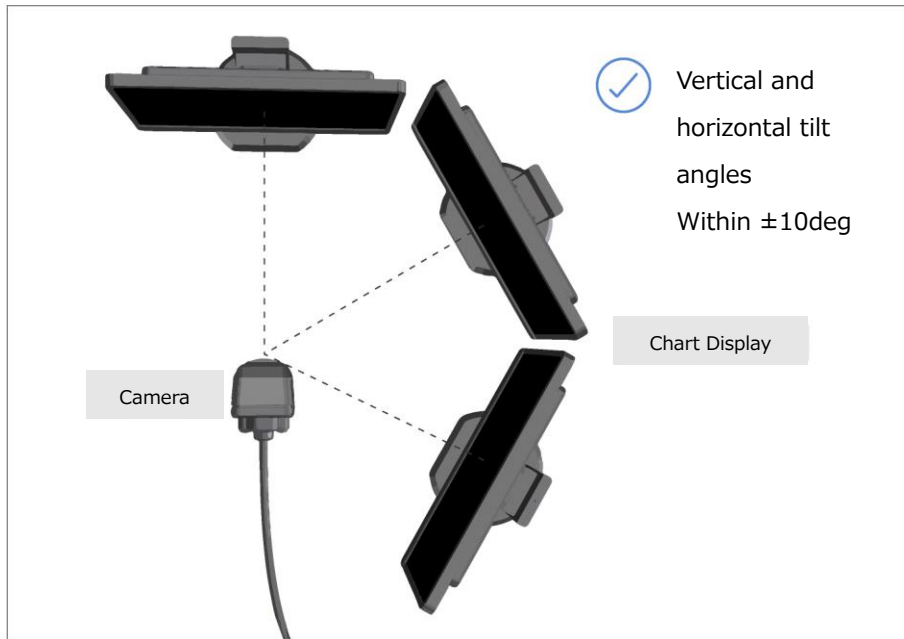

Figure 3-5 | Vertical and horizontal tilt angles

- **Distance between camera and chart display (WD: Working Distance)**

The appropriate WD depends on the following parameters.

- Camera Picture Height [Pixel]
(Camera Settings Selection in menu Select Camera)
- Picture Height of chart display [Pixel]
(Displayed in Resolution of Measurement Settings menu)
- Maximum frequency of MTF measurement [Cyc/Pixel]
(Set in Maximum Frequency in the Measurement Settings Menu)

Adjust the W/D ratio (WD) so that the Relative Resolution is at least 6 times the Maximum Frequency (Cyc/Pixel) and within the range of 3 to 10.

The Relative Resolution can be expressed by the following formula

$$[\text{Relative Resolution}] = [\text{Picture Height of Chart Display}] \times [\text{Shooting Ratio}] / [\text{Picture Height of Camera}]$$

$$([\text{Shooting Ratio}] = [\text{Vertical Length of Camera Image}] / [\text{Vertical Length of Display}])$$

For example, consider whether WD is appropriate when measured under the following conditions

- Picture Hight of the camera = 720 Pixel
- Picture Hight of chart display = 1080 Pixel
- Maximum frequency of MTF measurement = 0.65 Cyc/Pixel
- Shooting Ratio = 2.5 / 1 = 2.5

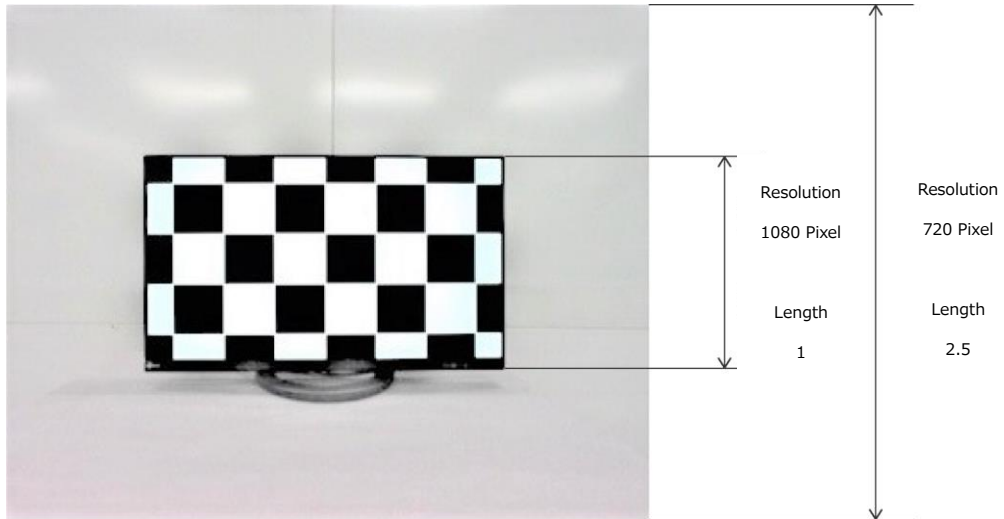

Figure 3-6 | WD

Relative resolution is defined as 6 times or more than Maximum Frequency (Cyc/Pixel), so it must be $0.65 \times 6 = 3.9$ or more.

On the other hand, the one is found to be 3.75 from the following equation.

[Relative Resolution]=[Picture Hight of Chart Display]×[Shooting Ratio]/[Picture Hight of the Camera]

$$= 1080 \times 2.5 / 720$$

$$= 3.75$$

These indicate that relative resolution is not sufficient. In such cases, it is necessary to use a higher resolution display or take more working distance. In this example, WD is appropriate when the shooting ratio is 2.6 or higher.

The required relative resolution and the measured relative resolution can be checked in the output data after measurement.

[Reference] 「5.4 Output Settings Menu」

4 Basic Measurements

This section describes the basic measurement procedures in camera mode and file mode.

In camera mode, the camera image is acquired directly to the PC and measured. Normally, this mode should be used for measurement.

In file mode, the camera images are imported in file format and measured. Use this mode for measurements when the camera image cannot be acquired directly to the PC.

4.1 Measurement in Camera Mode

As an example here, measurements are performed under the following conditions.

Number of Displays :	2
Number of ROIs :	2 (Per display)
Chart Types :	standard chart

1 Setting up.

Refer to "3.2 Settings."



Figure 4-1 | Settings

2 Start SFR-Fit on the PC.

SFR-Fit will start with the settings from the last time it was closed.

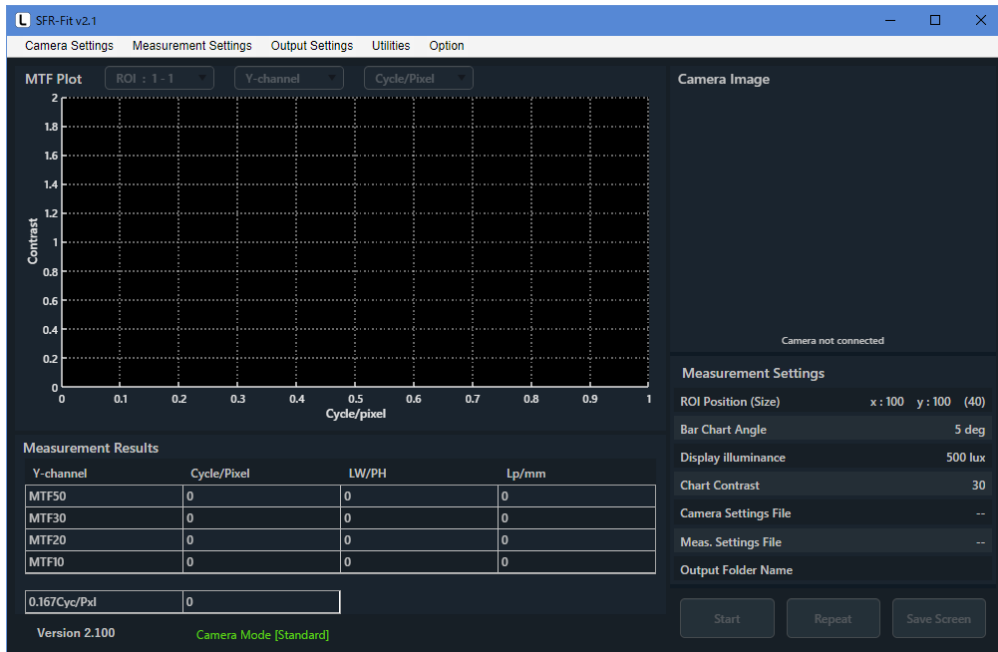

Figure 4-2 | Main window

3 At Measurement Settings menu > Edit > Measurement Parameters tab, set up the settings for the measurement.

Image Acquisition Mode to Camera and Chart Type to Standard.

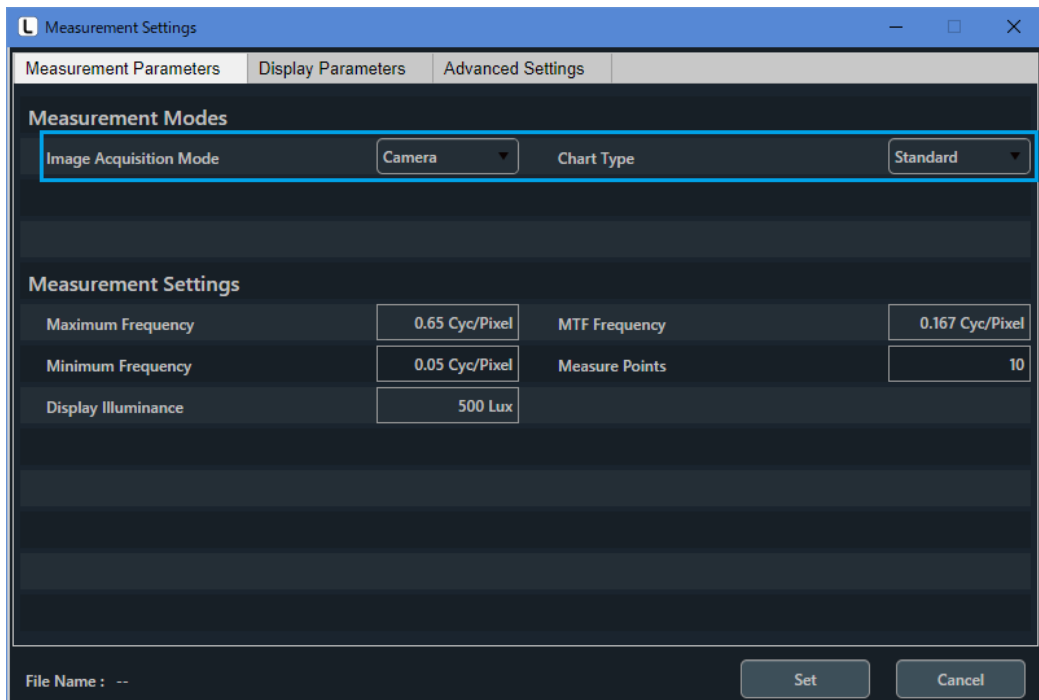

Figure 4-3 | Measurement Parameters tab

4 Select the Display Parameters tab to set the chart display settings.

Since we will be using two chart displays, we will assign the displays to No. 1 and No. 2. Select the display other than the main display.

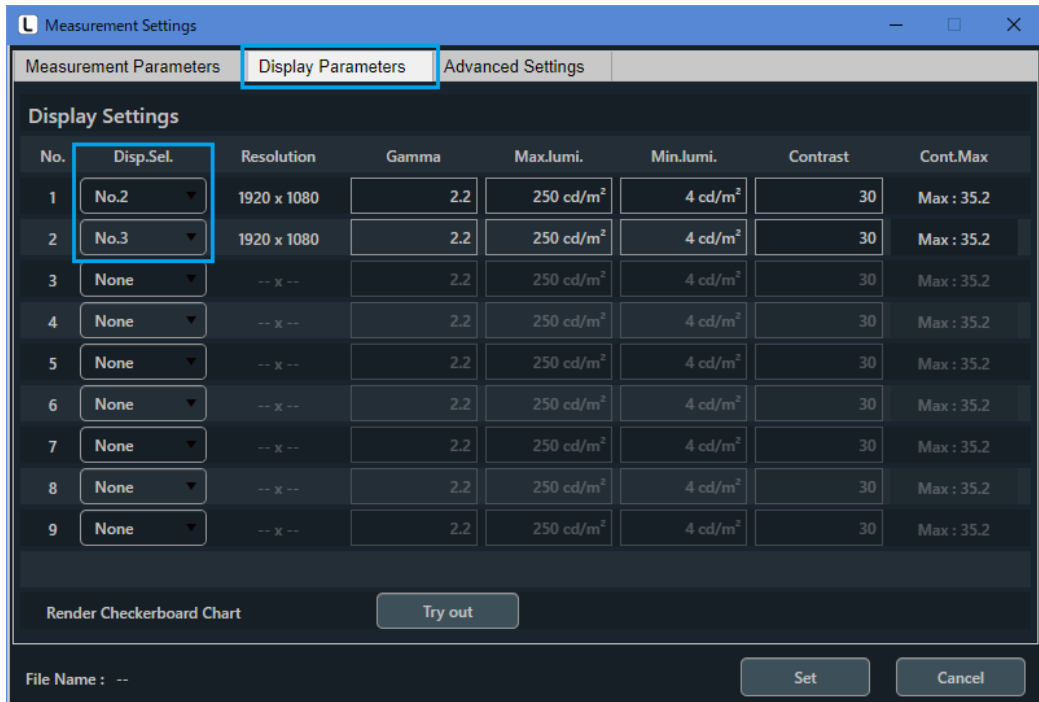

Figure 4-4 | Display Parameters tab

5 Click the Try out button to check that the checker chart and the display number appear correctly on the chart display.



Figure 4-5 | Try out

6 Click the Set button to check the setting.

7 Camera Settings menu > Edit to set up the camera

Select the camera under test in Select Camera.

In Device Properties shows the camera settings. Make changes as necessary.

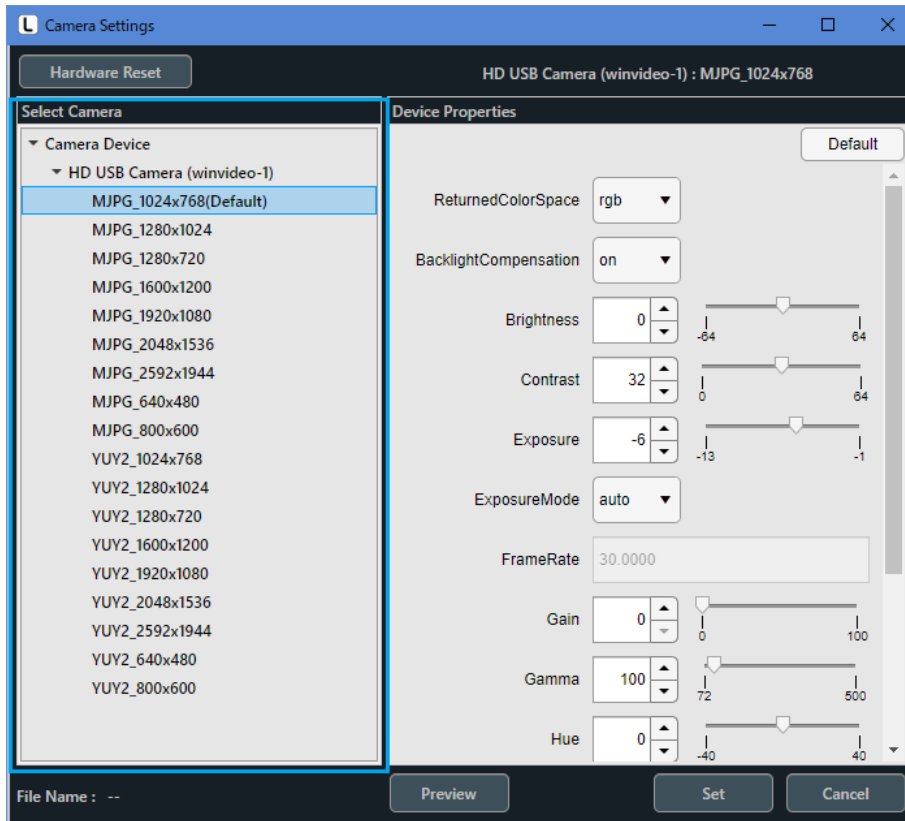

Figure 4-6 | Camera Settings window

- 8 Click the Preview button to check that the camera image has been properly displayed. when there are no problems with the camera image, close the window with "X".

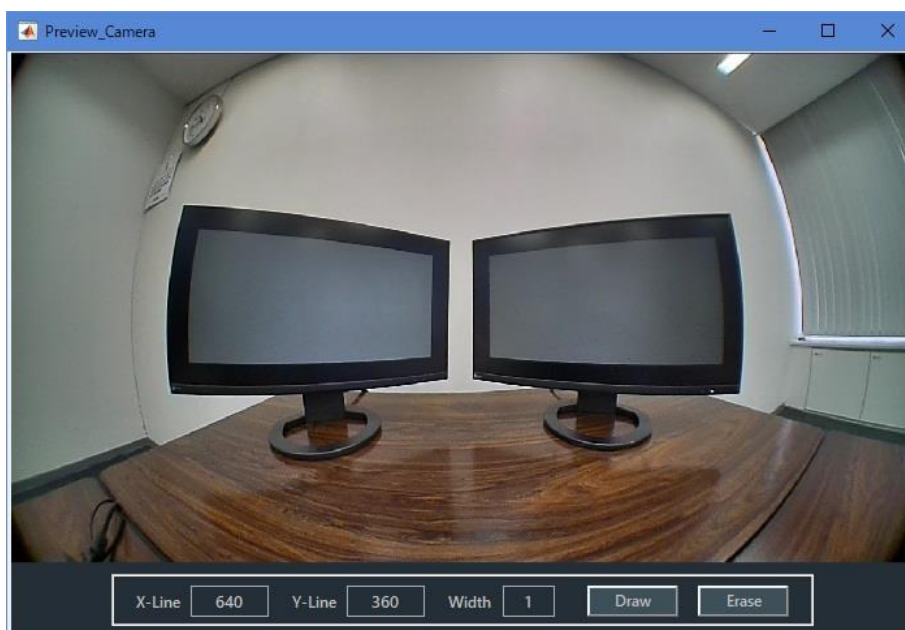

Figure 4-7 | Preview_Camera window

9 Click the Set button to check the setting.

10 At Output Settings menu > Edit, set the output data.

The Folder / File Settings allows you to set the data output folder, the Output Data Settings allows you to set the type of output data, and the Pop-up Graph Settings allows you to set the type of graph to be displayed after the measurement.

In this example, the following settings are used.

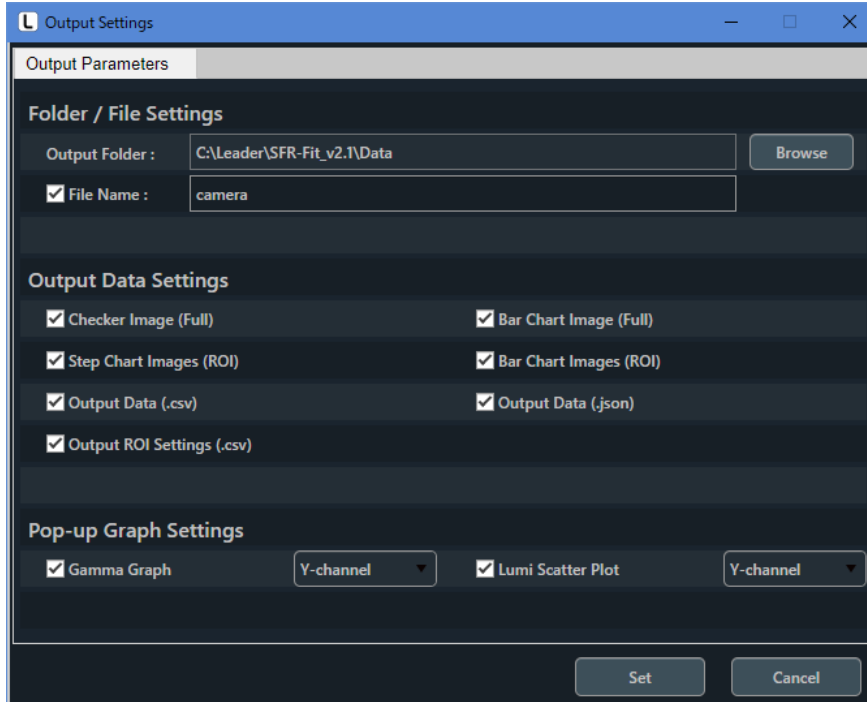

Figure 4-8 | Output Settings window

11 Click the Set button to check the setting.

12 Click the Start button.

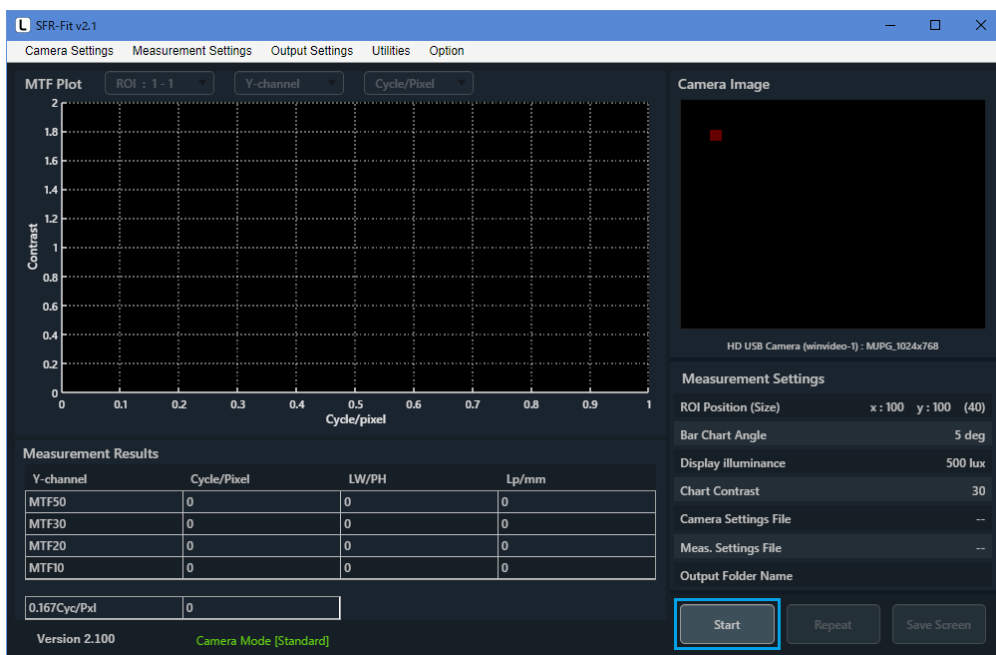

Figure 4-9 | Main window

13 Layout the ROI.

To add a ROI, right click, select "Add ROI" and choose a display number and ROIs are numbered in the format "display number - ROI number". In this case, two ROIs will be set up for one display, so that "1-1", "1-2", "2-1", and "2-2" will be displayed.

To move a ROI, double-click on the ROI and then drag the ROI. Normally the ROI is red, but when double-clicked it turns green and can be moved.

To resize the ROI, drag the four corners when the ROI is green. Or, right-click when the ROI is green and select Edit.

To delete a ROI, right-click when the ROI is green and select Delete.

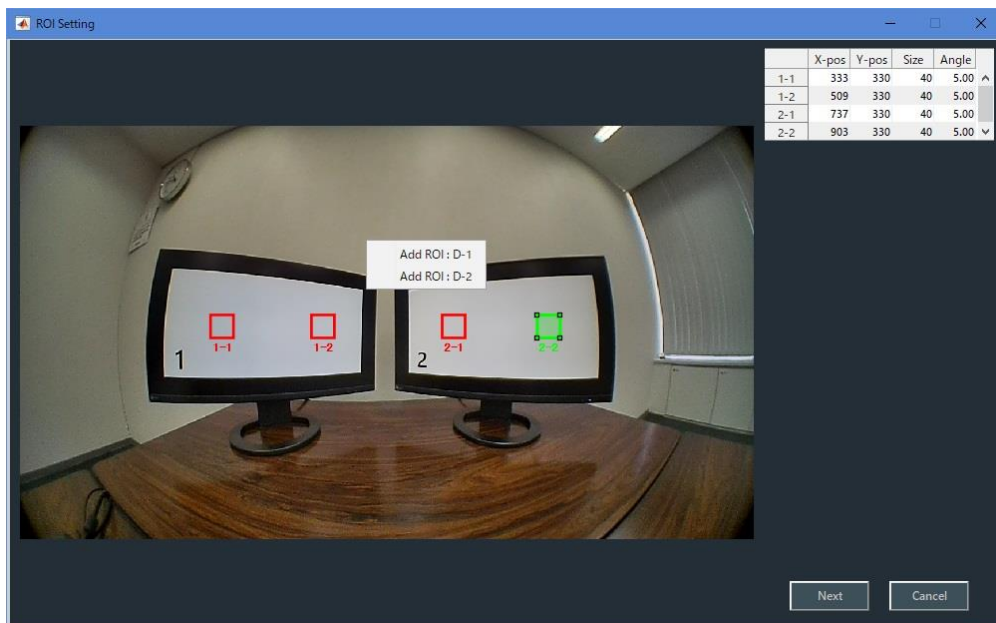

Figure 4-10 | ROI Setting window

14 Click the Next buttons.

The measurement proceeds automatically when the Next button is clicked and is complete when the MTF graph is displayed.

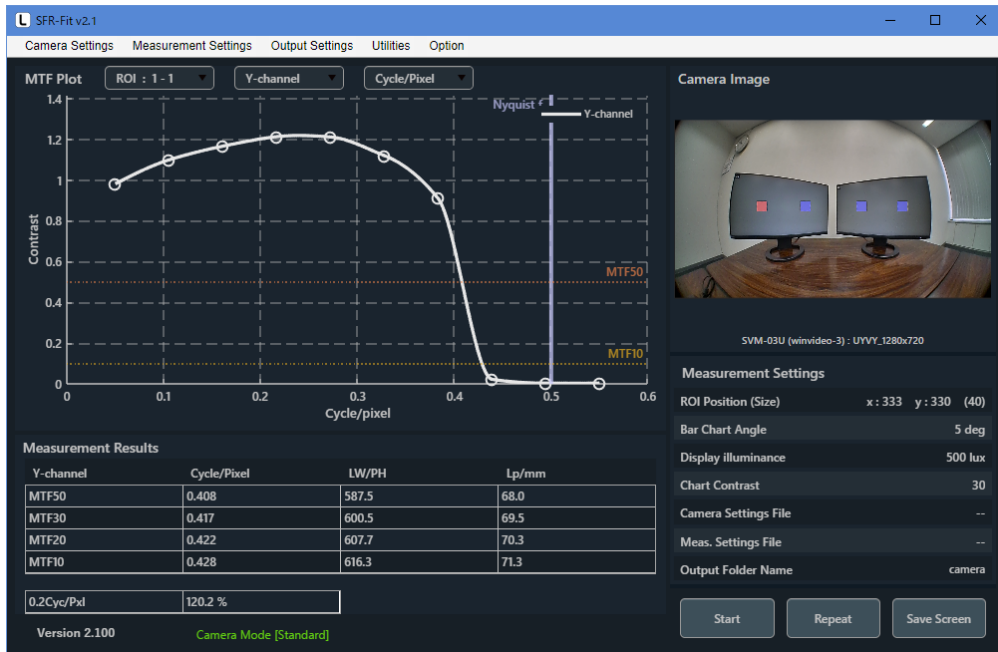

Figure 4-11 | Main window

When the measurement is completed, the two types of graphs are also displayed in a separate window.

The Gamma Graph window displays the OECF response and LUT (Look Up Table).

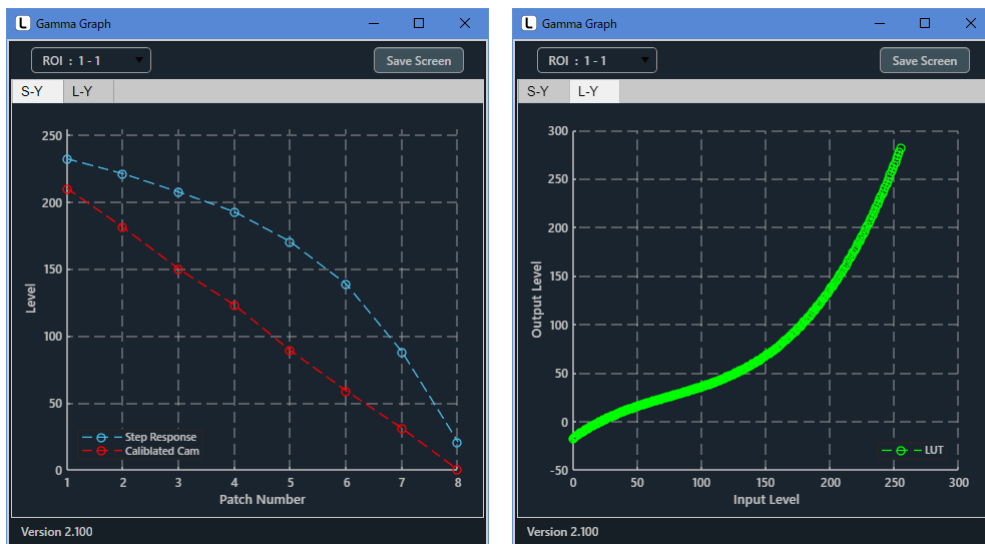

Figure 4-12 | Gamma Graph window

The Lumi Scatter Plot window shows the sampling waveforms of the bar charts.

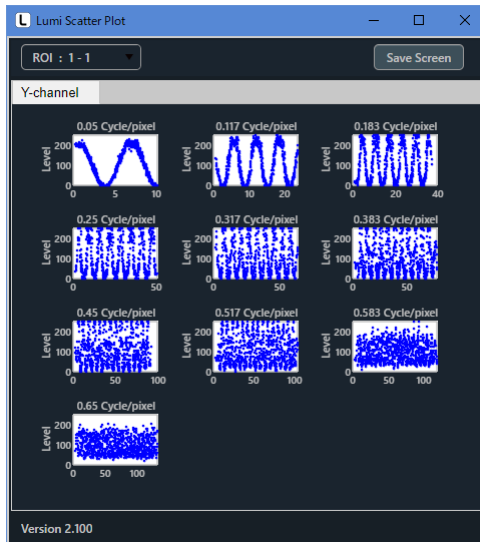

Figure 4-13 | Lumi Scatter Plot window

In addition, the output data about this measurement will be saved in “C:¥Leader¥SFR-Fit_v2.1¥Data¥camera” as follows.

SFR Viewer can use these data to display the previously measured data again.

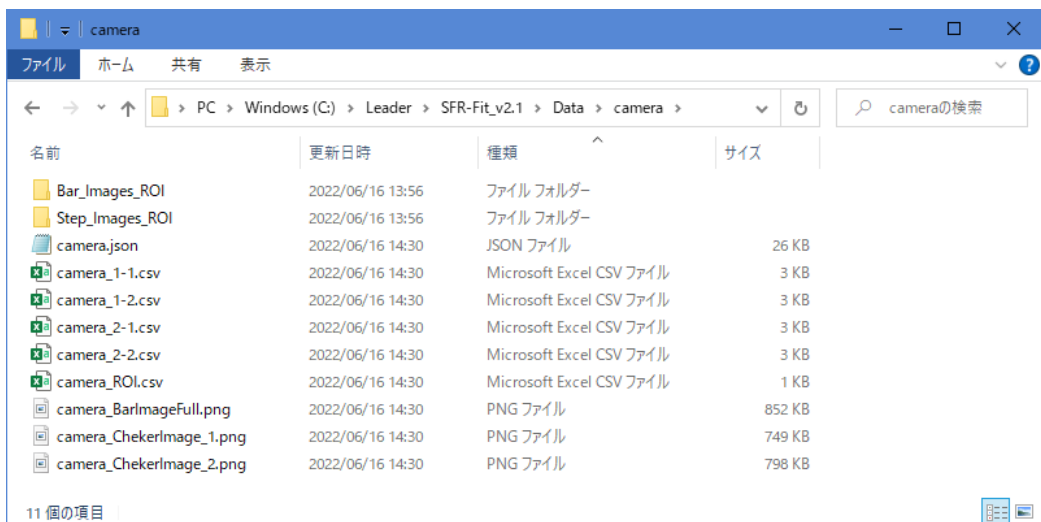

Figure 4-14 | Output data

4.2 Measurement in File Mode

As an example here, measurements are performed under the following conditions.

Number of Displays :	1
Number of ROIs :	1
Chart Types :	Single Chart

1 Start SFR-Fit on the PC.

SFR-Fit will start with the settings from the last time it was closed.

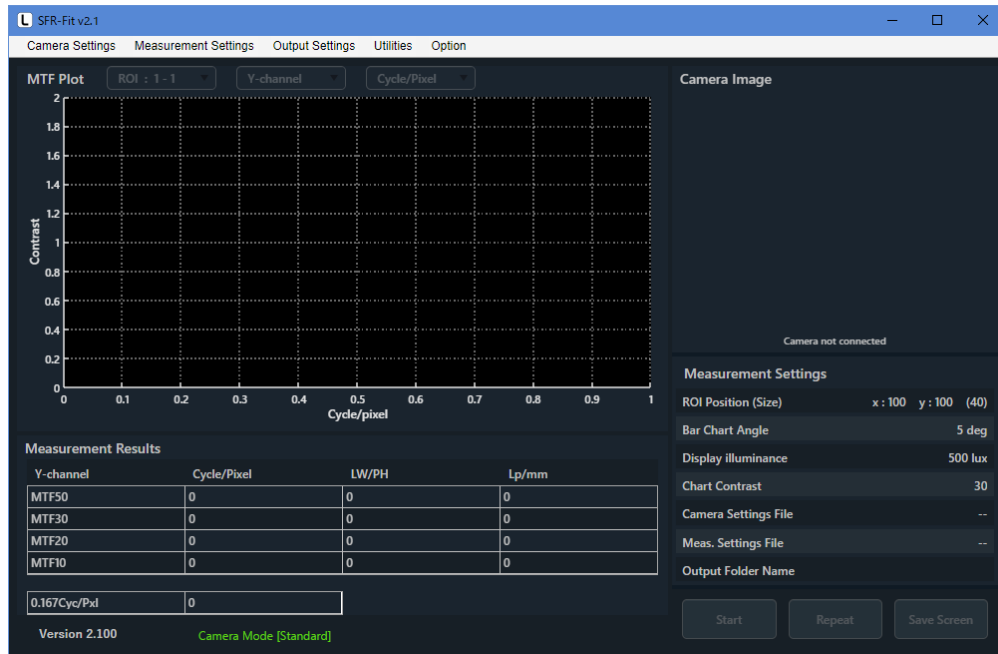

Figure 4-15 | Main Window

2 At Measurement Settings Menu > Edit > Measurement Parameters tab, set up the settings for the measurement.

Set Image Acquisition Mode to File and Chart Type to Single.

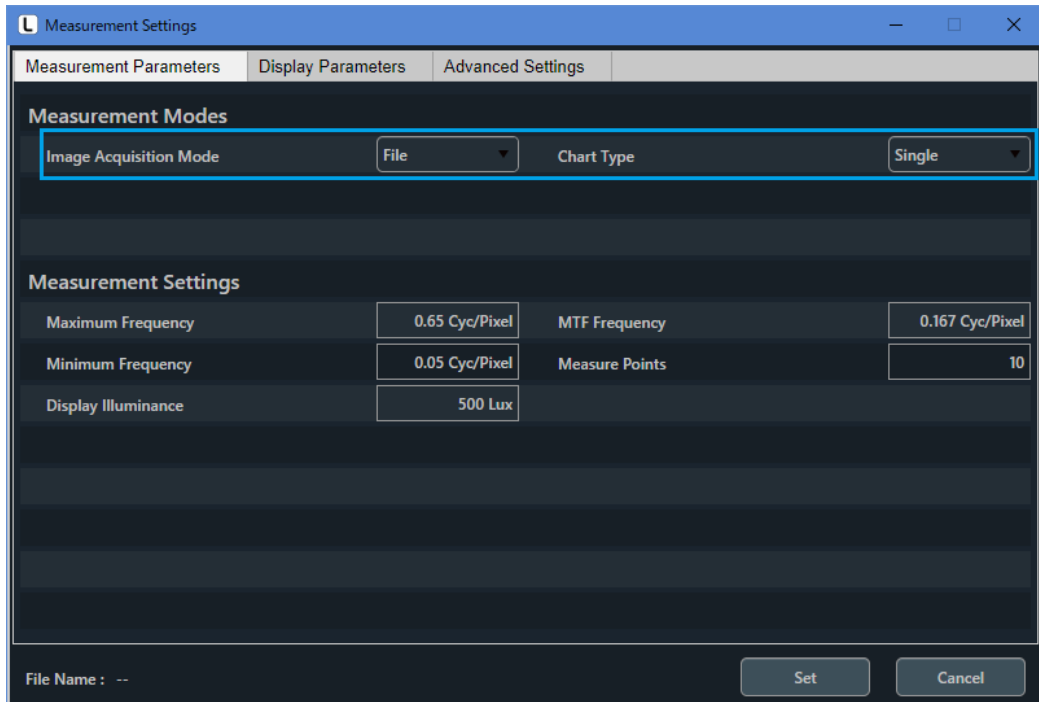

Figure 4-16 | Measurement Parameters tab

3 Select the Display Parameters tab to set up the chart display.

Assign the display to No. 1, since one chart display will be used in this case. Select the display other than the Main display in Disp.Sel.

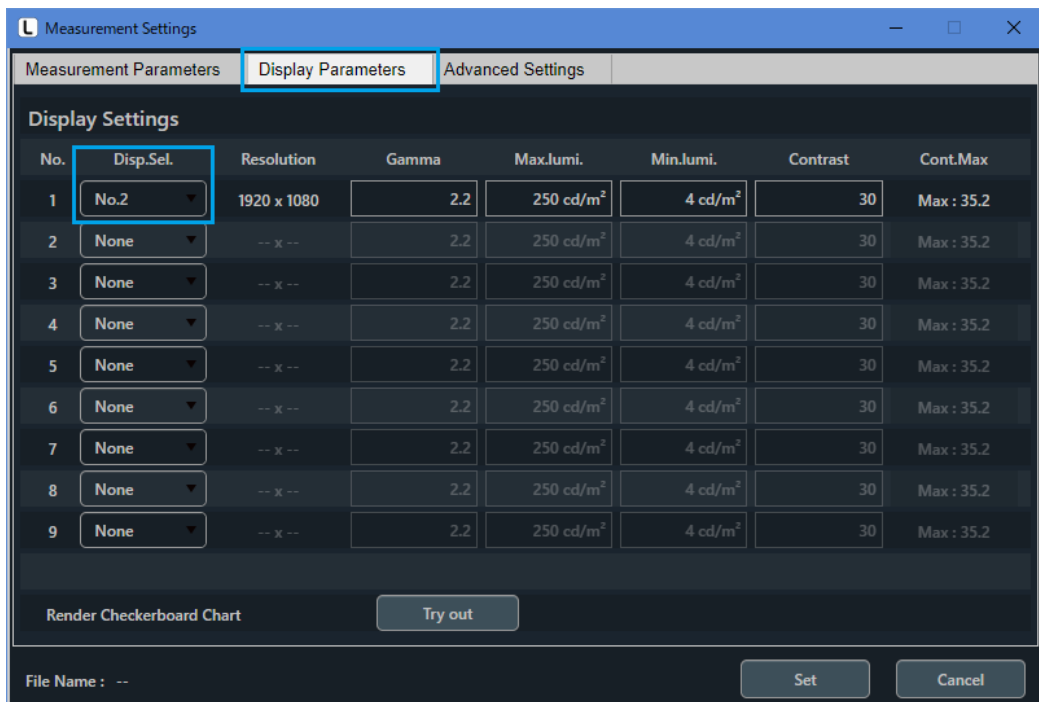

Figure 4-17 | Display Parameters tab

- 4 Click the Try out button to check that the checker chart and the display number appear correctly on the chart display.



Figure 4-18 | Try out

- 5 Click Set button to check the setting.
- 6 At Output Settings Menu > Edit, set the output data.

Set the folder for data output in the Folder/File setting, the type of output data in the Output Data setting, and the type of graph to be displayed after measurement in the Pop-up Graph setting. Here, as an example, we set up the following. When using Single Chart, nothing is output even if step chart image (ROI) is turned on.

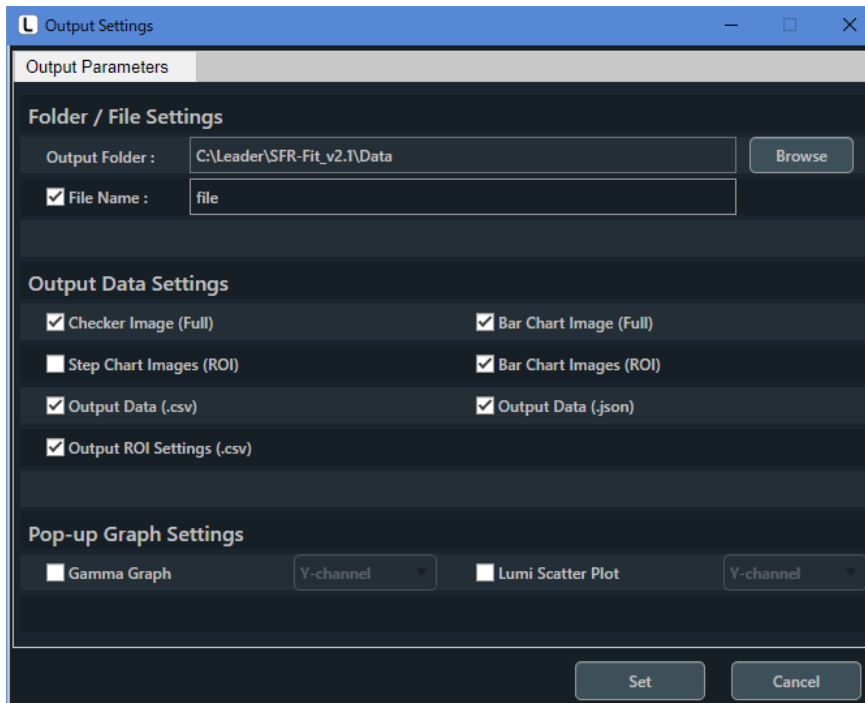

Figure 4-19 | Output Settings Window

- 7 Click Set button to check settings.

8 Click the start button.

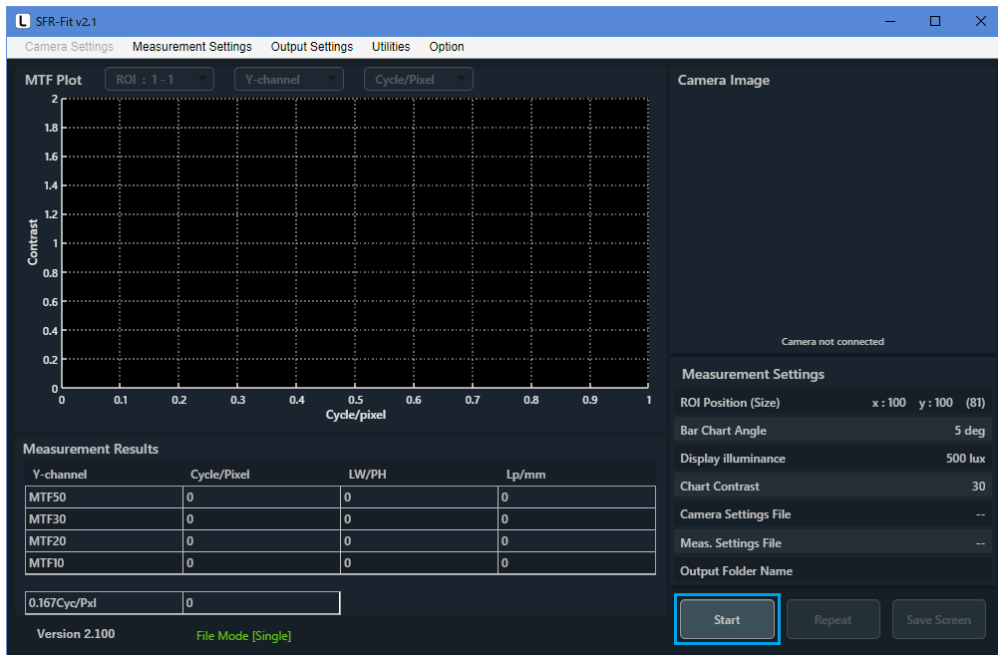

Figure 4-20 | Main Window

When the Start button is clicked, the message appears on the PC and an active area chart appears on the chart display.

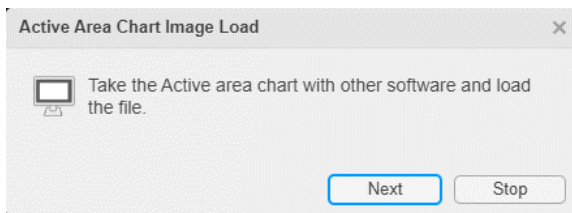

Figure 4-21 | Active Area Chart Image Load



Figure 4-22 | Active Area Chart

9 Take a picture of the active area chart with camera under test and save it to the PC.

File formats are jpg, jpeg, png, or bmp. Note that highly compressed jpg and jpeg files may affect the measurements.



Figure 4-23 | Camera images

10 Click the Next button.

Figure 4-24 | Active Area Chart Image Load

11 Select the file saved in step 9 and click the Open button.

Figure 4-25 | Load active chart Image File

12 Layout the ROI

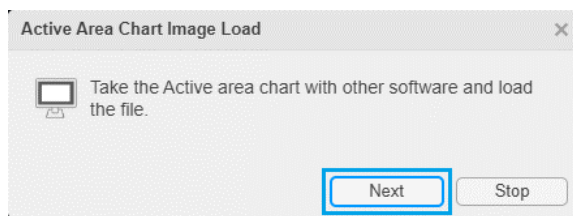
The ROIs are numbered in the format "display number - ROI number". In this case, to set one ROI, one of "1-1" should be displayed.

To move a ROI, double-click on the ROI and then drag the ROI. Normally the ROI is red, when double-clicked it turns green and can be moved.

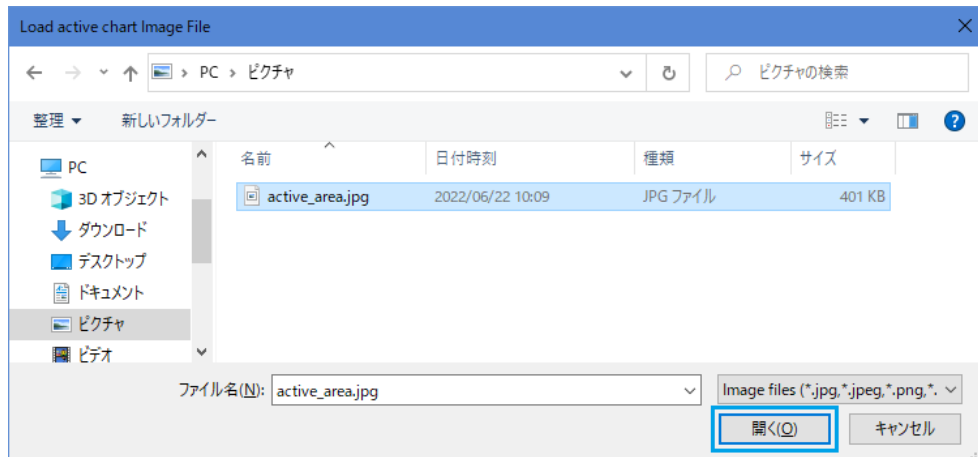
To delete a ROI, right-click when the ROI is green and select Delete. Or, when the ROI is green, right-click and select Edit.

When using a Single Chart, the ROI size is fixed at 81. It cannot be changed.

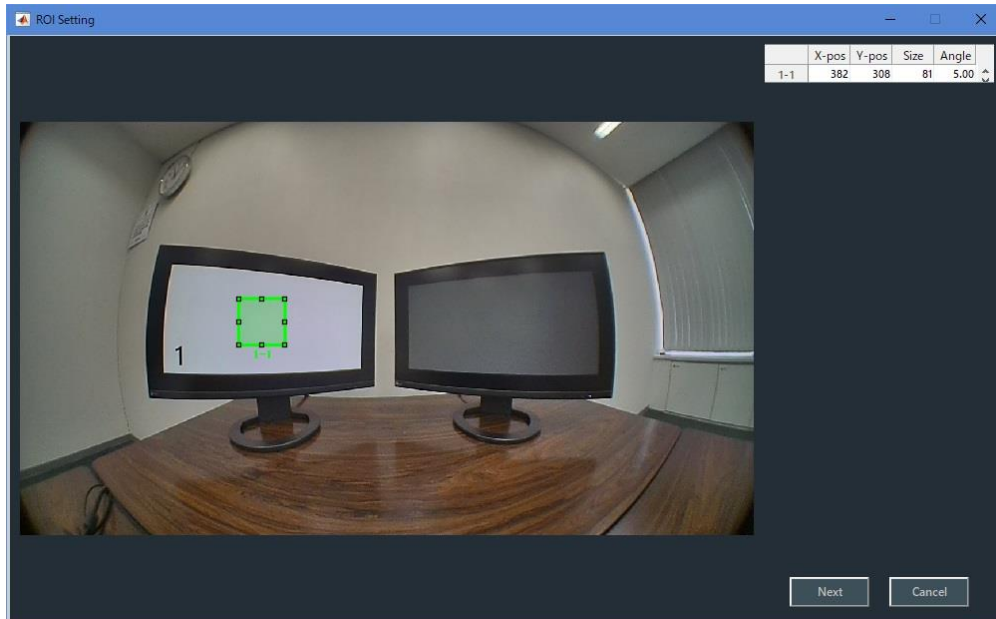

Figure 4-26 | ROI Setting Window

13 Click the Next button.

When the Next button is clicked, the message appears on the PC and a checker chart appears on the chart display.

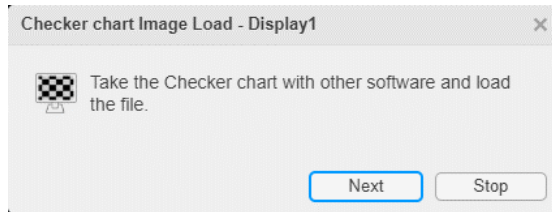

Figure 4-27 | Checker chart Image Load

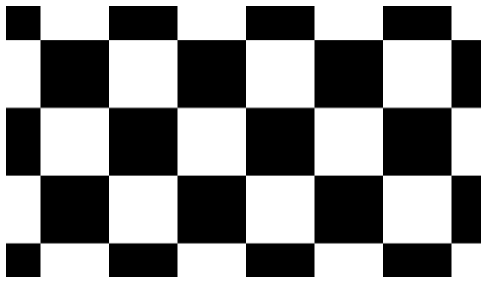

Figure 4-28 | Checker chart

14 Take a picture of the checker chart with the camera under test and save it to the PC.

Figure 4-29 | Camera image

15 Click the Next button.

Figure 4-30 | Checker chart Image Load

16 Select the file saved in step 14 and click the Open button.

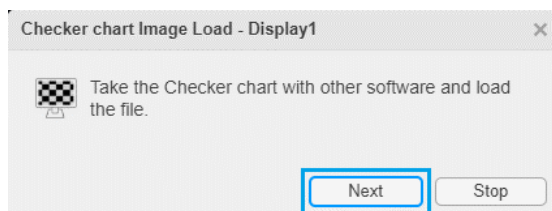
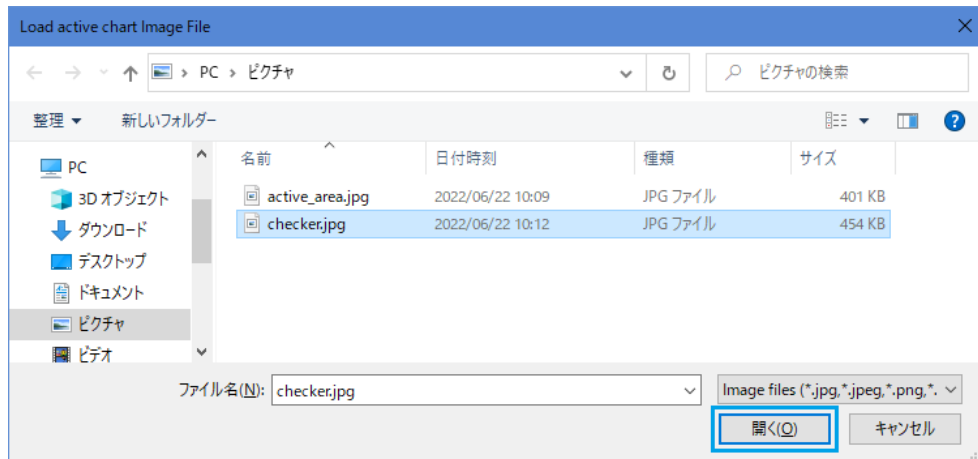

Figure 4-31 | Load active chart Image File

When the Open button is clicked, the message appears on the PC and the Single Chart on the chart display.

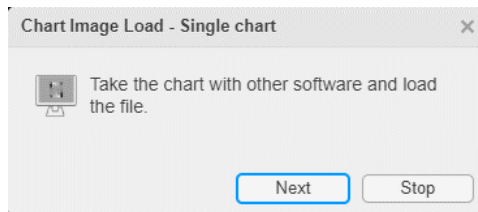

Figure 4-32 | Chart Image Load

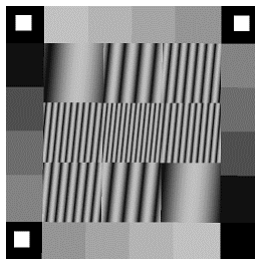

Figure 4-33 | Single Chart

17 Take a picture of the Single Chart with camera under test and save it to the PC.



Figure 4-34 | Camera image

18 Click the Next button.

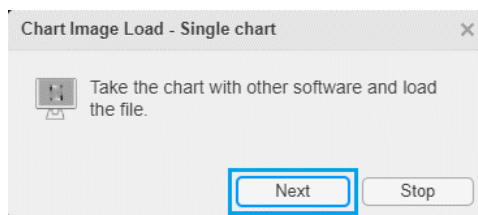

Figure 4-35 | Chart Image Load

19 Select the file saved in step 17 and click the Open button.

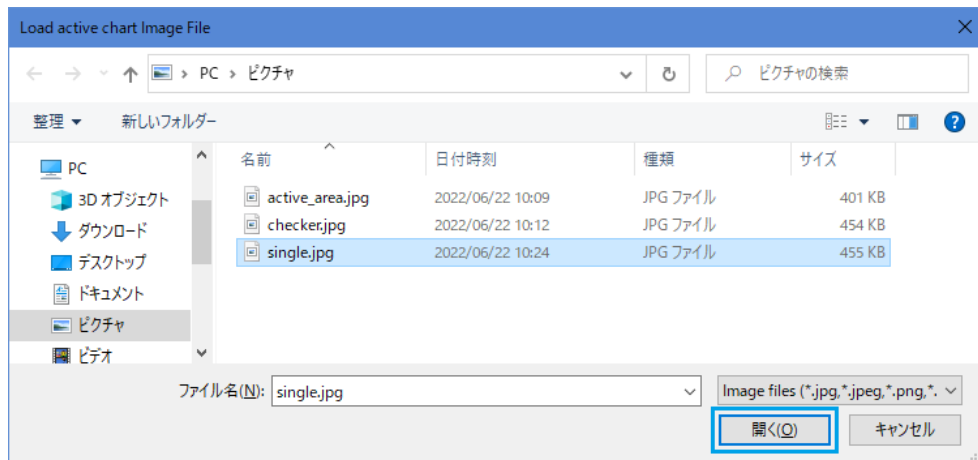

Figure 4-36 | Load active chart Image File

The measurement proceeds automatically when the Open button is clicked, and is complete when the MTF graph is displayed.

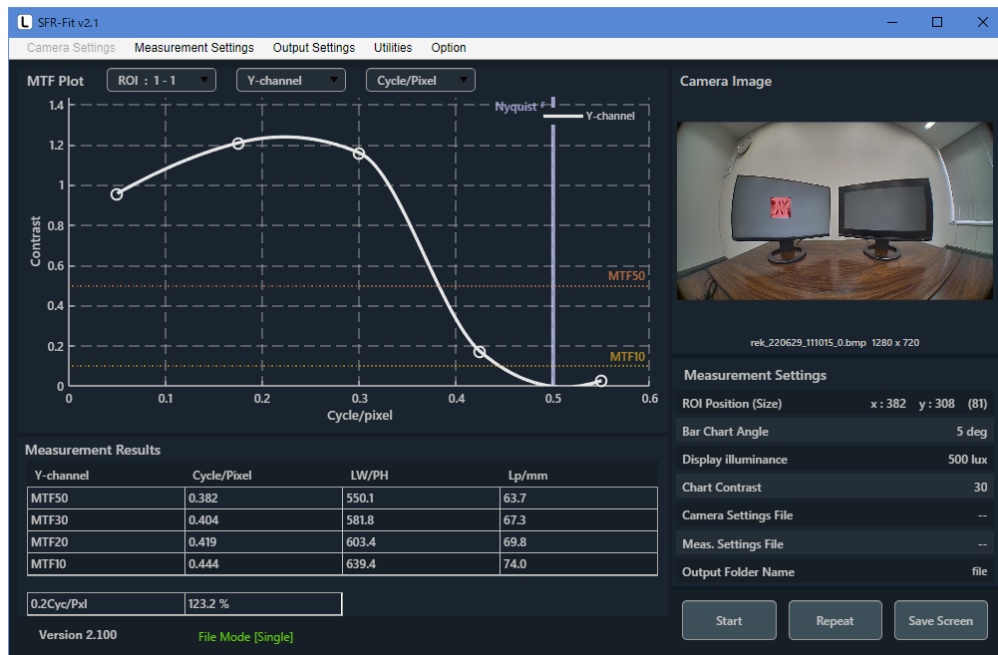

Figure 4-37 | Main Window

When the measurement is completed, the output data for the current measurement is saved in "C:¥Leader¥SFR-Fit_v2.1¥Data¥file" as follows.

The SFR Viewer can use these data to display previously measured data again.

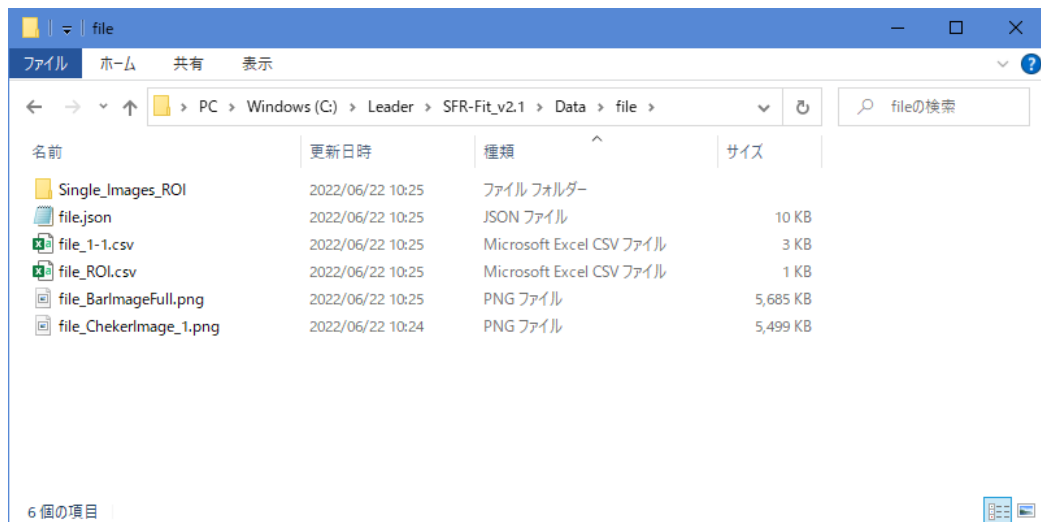

Figure 4-38 | Output

5 Description of each Window

5.1 Main Window

Set settings for measurement and displays measurement results.



Figure 5-1 | Main window

Note that SFR-Fit will start with the same settings as the last time it was closed.

The settings are saved in "C:¥Leader¥SFR-Fit_v2.1¥Backup" at any time as follows

Note that deleting these files will initialize the settings.

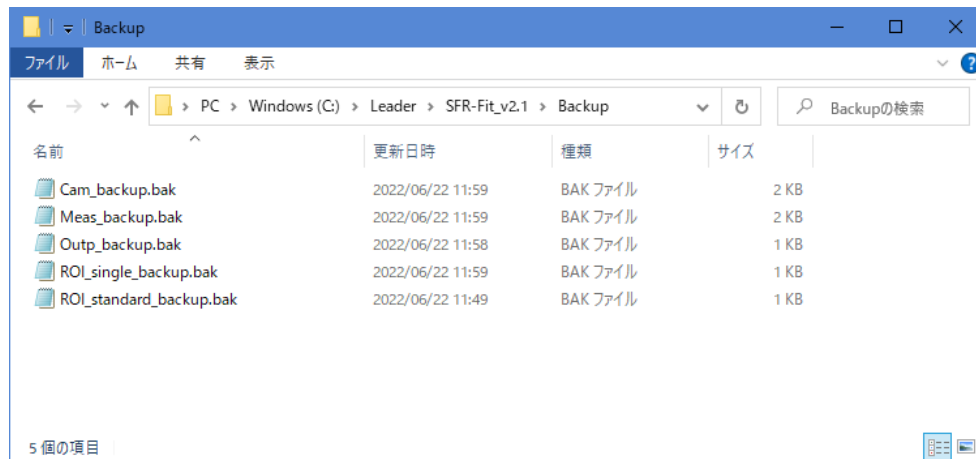

Figure 5-2 | Backup

1 Menu

Set settings for measurement.

[Reference] [5.2 Camera Settings menu] [5.3 Measurement Settings menu]
[5.4 Output Settings menu] [5.5 Utilities menu] [5.6 Option menu]

2 MTF Plot

Displays the measurement results in an MTF graph.

[Reference] [5.7 MTF Plot window]

3 Measurement Results

Displays the MTF50, MTF30, MTF20, and MTF10 spatial frequencies in Cycle/Pixel, LW/PH, and Lp/mm for the ROI and channel selected in the MTF Plot. When the channel is All-channel, Y-channel values are displayed.

4 Contrast

For the ROI and channel selected in the MTF Plot, the contrast of the spatial frequency set in the MTF Frequency in the Measurement Settings menu is displayed in %.

When the channel is All-channel, Y-channel values are displayed.

5 Camera Image

Displays the camera image at the completion of the measurement.

ROIs selected by MTF Plot is displayed in red, and other ROIs are displayed in blue.

6 Measurement Settings

The main settings for the ROI selected in the MTF Plot are displayed here.

ROI Position (Size) :	Displays the position and size of the ROI set in ROI Setting.
Bar Chart Angle :	Displays the bar chart angle set in ROI Setting.
Display illuminance :	Displays the illuminance of the chart display surface as set in the Measurement Settings menu.
Chart Contrast :	Displays the bar chart contrast set in the Measurement Settings menu.
Camera Settings File :	Displays the file name when a file is saved or loaded in the Camera Settings menu. If the setting is changed while the file name is displayed, a "*" will be added to the beginning of the file name.
Meas. Settings File :	Displays the file name when a file is saved or loaded in the Measurement Settings menu. If the settings are changed while the file name is displayed, "*" will be added to the beginning of the file name.
Output Folder Name :	Displays the output file name set in the Output Settings menu.

7 Version

Displays the version of SFR-Fit.

8 Measurement Mode

Displays the measurement mode selected under Image Acquisition Mode in the Measurement Settings menu and the chart type selected under Chart Type.

Camera Mode [Standard] :	Measurements are taken in camera mode using a standard chart.
Camera Mode [Single] :	Measure in camera mode using a Single Chart.
File Mode [Standard] :	Measurements are taken in file mode using a standard chart.
File Mode [Single] :	Measure in file mode using a Single Chart.

9 Seq. No.

Displays the progress of the measurement, which can be turned on or off in the Option menu.

[Reference] 「5.6 Option menu」

10 Start button

Start measurement.

11 Repeat button

After measurement, perform the measurement again under the same conditions.

The Repeat button is disabled when a setting window is opened in the Camera Settings menu or Measurement Settings menu, or a setting file is loaded.

12 Save Window button

The Save Screen button saves the current window in png, jpg, tif, or pdf format.

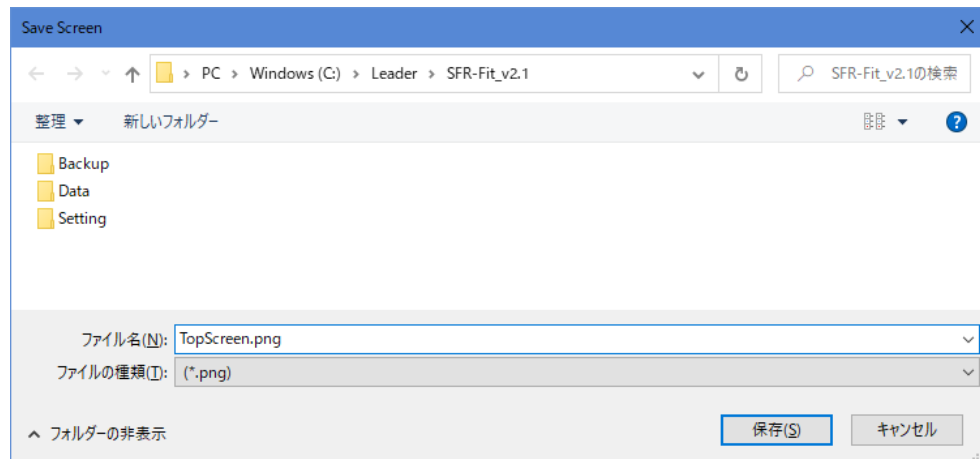

Figure 5-3 | Save Window

5.2 Camera Settings Menu

The camera settings menu allows you to set camera settings.

This cannot be set when Image Acquisition Mode in the Measurement Settings menu is set to File.

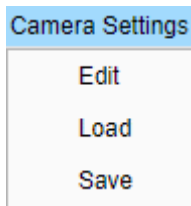

Figure 5-4 | Camera Settings menu

Edit :	Set the camera settings.
Load :	Loads a saved configuration file.
Save :	Saves the settings made in Camera Settings to an arbitrary folder.

Select the camera in "Select Camera" and change the settings in "Device Properties" if necessary.

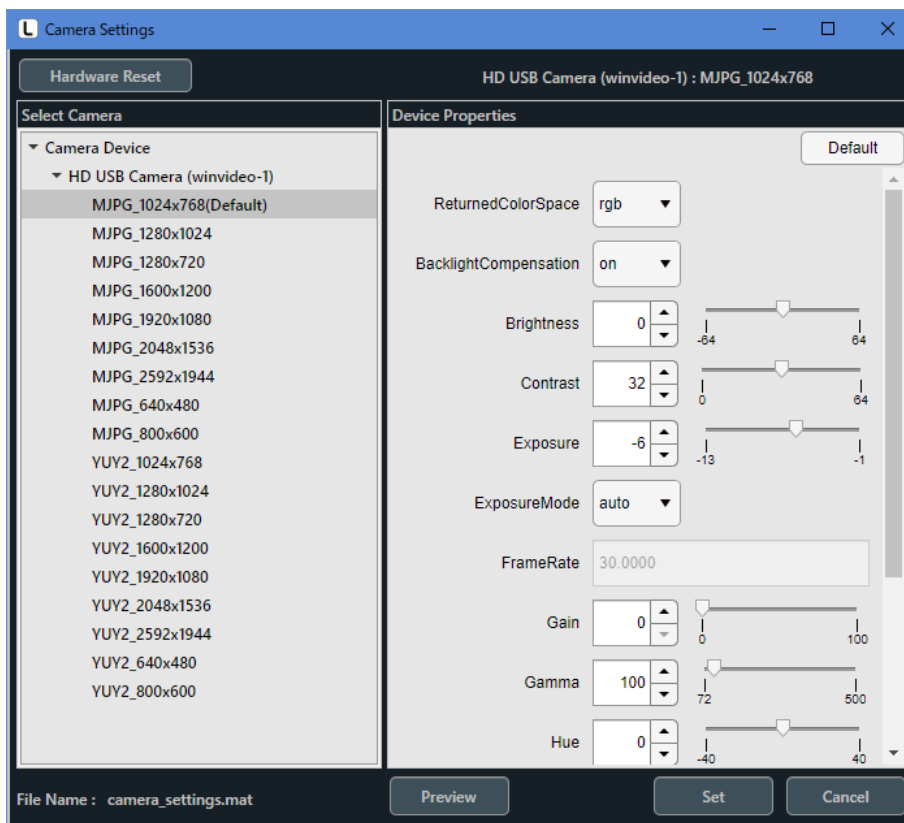

Figure 5-5 | Camera Settings Window

- **Hardware Reset button**

Refresh the "Select Camera" display.

The "Select Camera" shows the cameras connected to the PC, but it is not automatically updated when the camera is reconnected.

In such cases, selecting the Hardware Reset button will update the display.

- **Select Camera**

Displays the cameras connected to the PC. Select the camera and resolution you wish to use.

- **Device Properties**

Displays the settings for the camera selected in "Select Camera". The settings vary depending on the camera. Change the settings as necessary.

Select the Default button to return the settings to their default values.

- **File Name**

When a settings file is loaded using "Load" in the Camera Settings menu, the file name is displayed. When the settings are changed while the file name is displayed, a "*" will be added to the beginning of the file name.

- **Preview button**

The Preview Camera window opens in an other window, displaying the camera image selected in "Select Camera".

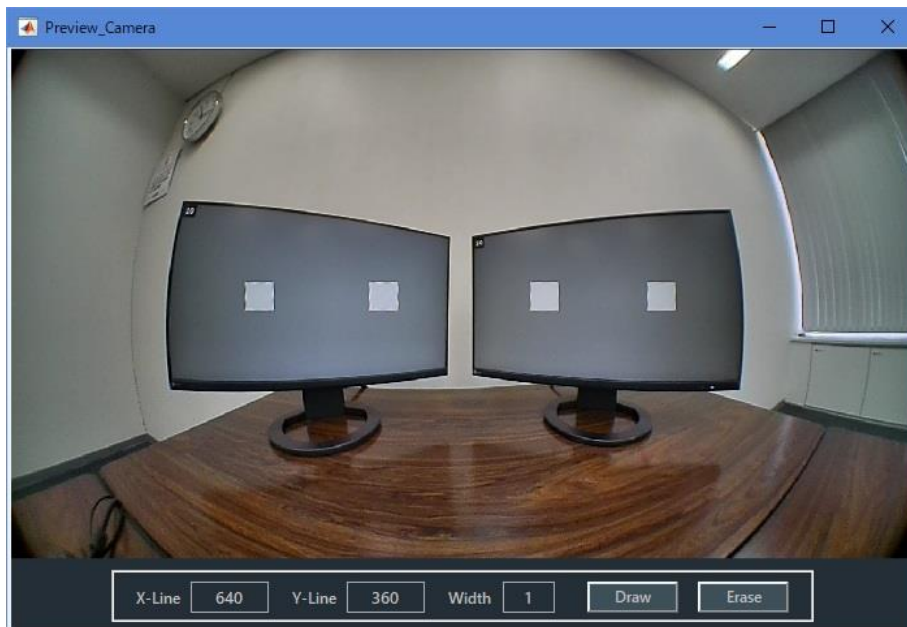

Figure 5-6 | Preview Camera Window

5 Description of each Window

Crosshairs can be displayed on the Preview_Camera window.

To display crosshairs, set "X-Line," "Y-Line," and "Width" and then click the Draw button.

The unit is Pixel, and the upper left corner is set to $(X, Y) = (0, 0)$.

To hide the crosshairs, click the Erase button.



Figure 5-7 | Preview_Camera Window

- **Set button**

Check the settings and close the Camera Settings window.

- **Cancel button**

Close the Camera Settings window without applying the settings.

5.3 Measurement Settings Menu

Measurement Settings Menu is used for settings related to measurement.

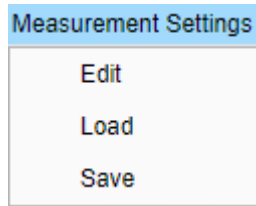

Figure 5-8 | Measurement Settings Menu

Edit :	Measurement settings window will open.
Load :	Load the settings file.
Save :	Save the settings file.

Select "Edit" to open the Measurement Settings Window, where you can set measurement settings. Use the tabs at the top of the window to change the settings.

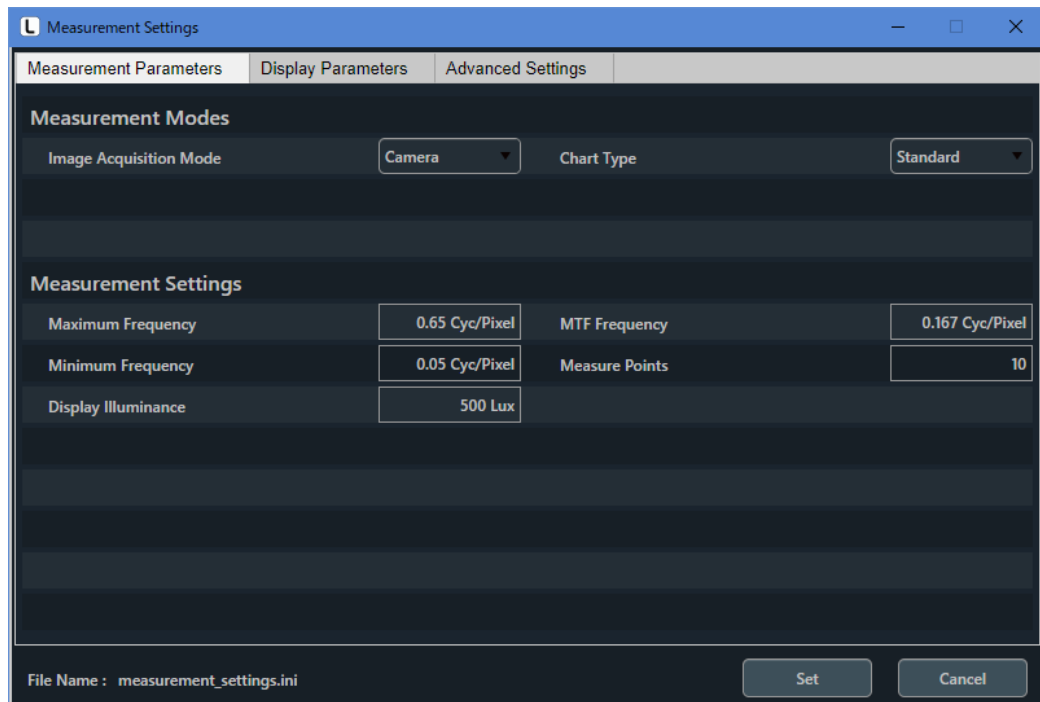

Figure 5-9 | Measurement Settings Window

- **File Name**

When a settings file is loaded, the file name is displayed. When the settings are changed while the file name is displayed, "*" is added to the beginning of the file name.

- **Set button**

Apply the setting changes and close the window.

- **Cancel button**

Closes the window without applying any setting changes.

5.3.1 Measurement Parameters Tab

In Measurement Parameters tab, you can set the settings for the measurement.

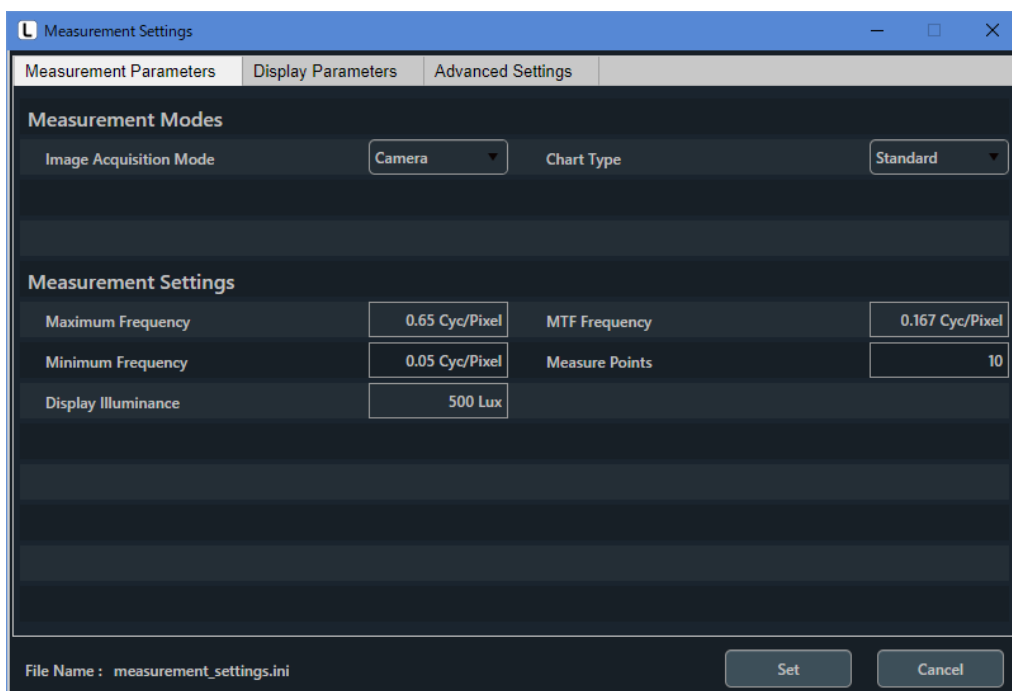

Figure 5-10 | Measurement Parameters tab

- **Image Acquisition Mode**

Select the measurement mode.

Parameters

Camera : The camera images are acquired directly to the PC and measured.

File : The camera images are imported in file format and measured. Use this mode for measurements when the camera image cannot be acquired directly to the PC.

Initial value

Camera

- **Chart Type**

Select the chart to be used for the measurement.

Parameters

Standard :	Use step and bar charts.
Single :	Use a chart that combines a step chart and a bar chart in one.

Initial value

Standard

- **Maximum Frequency**

Set the maximum value of the frequency measurement range, which must be greater than Minimum Frequency.

Relative Resolution must be at least 6 times higher than this value, so if you set a high frequency, you will need to use a higher resolution display or more WD.

[Reference] [3.2.4 Camera and Chart Display Placement]

Parameters

0.2 - 1 Cyc/Pixel

Initial value

0.65 Cyc/Pixel

- **Minimum Frequency**

Set the minimum value of the frequency measurement range, which must be less than Maximum Frequency.

Parameters

0.05 - 0.5 Cyc/Pixel

Initial value

0.05 Cyc/Pixel

- **Display Illuminance**

Set the illuminance of the chart display surface.

Parameters

100 - 10000 Lux

Initial value

500 Lux

The Display Illuminance setting method differs depending on the measurement conditions.

- When the camera's auto exposure function (AE: Auto Exposure) is enabled
Measure the illuminance of the chart display surface with an illuminance meter and set the value. The measurement environment at this time should be as follows

Reflectance of background surface : 18% gray

Illuminance of background surface : Equivalent to chart display surface illumination

If you do not have an illuminance meter or cannot prepare a measurement environment, follow the procedure below.

First, set the display settings in the Display Parameters tab of the Measurement Settings Menu.

[Reference] 「5.3.2 Display Parameters tab」

Next, in the Waveform Window of the Utilities Menu, click the Step Chart button. Select All [BT.601] or All [BT.709] for the channel and set the red line to match the step chart.

[Reference] 「5.5.3 Waveform」

Here, make sure that the level of the step chart section is within the graph.

For example, in the figure below, the lighter patch of step chart is saturated, so the Display Illuminance value should be decreased. At this time, the Contrast value in the Display Parameters tab will also change, so check both values.

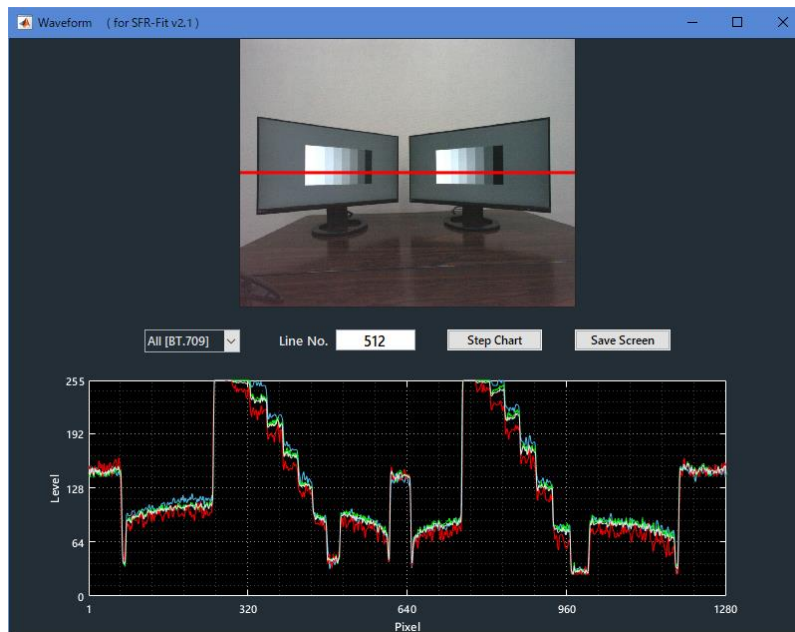

Figure 5-11 | Waveform Window

When the waveform of the step chart is displayed like the graph below, the illuminance adjustment is completed.

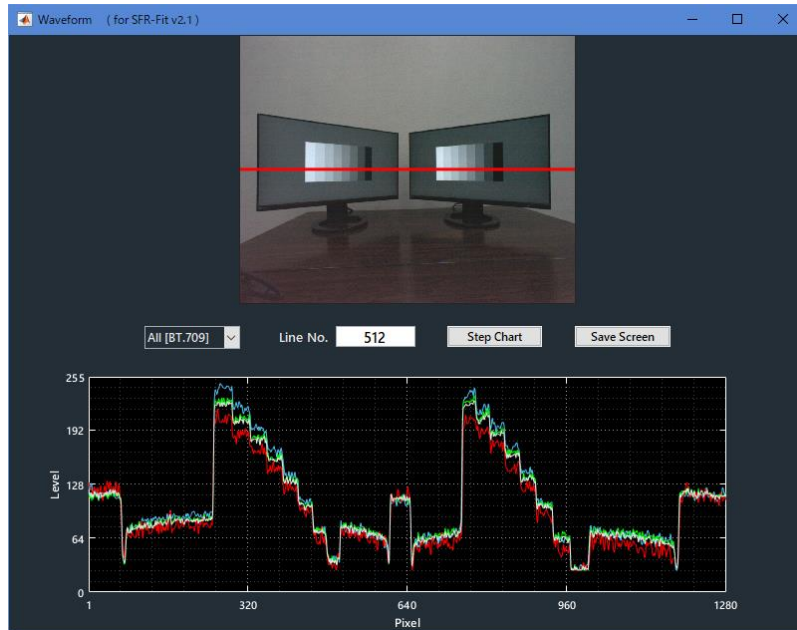

Figure 5-12 | Waveform Window

- If the camera's Auto Exposure function (AE: Auto Exposure) is disabled
You can set the desired chart illuminance. The display chart is displayed with the same luminance as the reflection chart.

- **MTF Frequency**

Can be set any frequency. SFR-Fit displays the contrast value at this frequency on Main Window. It must be greater than or equal to the Minimum Frequency and less than or equal to the Maximum Frequency.

Parameters

0.05 - 1 Cyc/Pixel

Initial value

0.167 Cyc/Pixel

- **Measure Points**

Set the number of measurement points. This setting is available when the chart type is Standard. When Chart Type is Single, the number is fixed at 5, regardless of the value set here.

Parameters

3 - 20

Initial value

10

5.3.2 Display Parameters Tab

The Display Parameters tab is used to set the display to be used as the chart display(s).

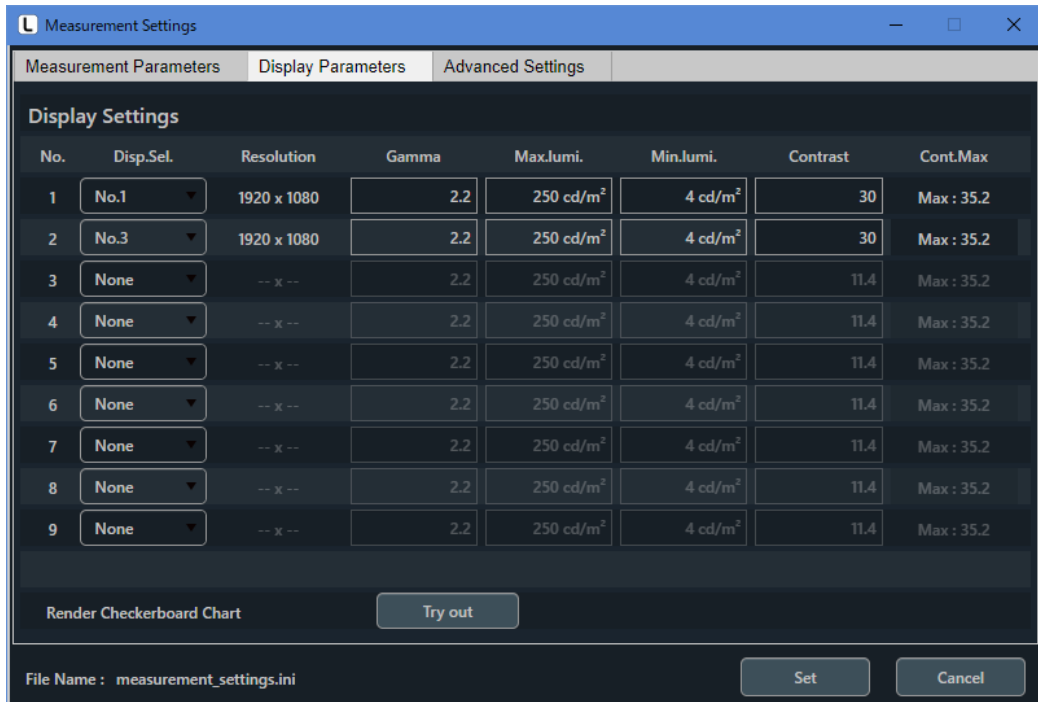

Figure 5-13 | Display Parameters tab

- **No.**

Displays the number of the chart displays to be defined in SFR-Fit. This number is tied to the ROI number.

- **Disp.Sel.**

Select the display to be used as the chart display(s).

The display number shown here is the display number identified by Windows (OS); please select a display other than the main display, as it includes the display of the PC on which SFR-Fit is started (main display).

Parameters

None / No.1 / No.2 / No.3 / No.4 / No.5 / No.6 / No.7 / No.8 / No.9 / No.10

Initial value

None

- **Resolution**

Displays the resolution of the chart display(s).

- **Gamma**

Set the gamma value for the chart display.
Normally set to 2.2.

Parameters

1.0 – 3.0

Initial value

2.2

- **Max.lumi.**

Set the maximum brightness of the chart display.

To get accurate chart contrast, use a luminance meter to measure.

First, place the chart display in the measurement environment and set the luminance meter in the camera position.

Next, the chart display shows an RGB (255, 255, 255) white pattern yourself.

Set the value measured by the luminance meter to Max.lumi.

If a luminance meter is not available, set the luminance specification value (catalog spec) of the display.

Parameters

100 - 1000 cd/m²

Initial value

250 cd/m²

- **Min.lumi.**

Set the maximum brightness of the chart display.

When using a luminance meter, measure in the same way as Max.lumi.

Show a black pattern of RGB (0, 0, 0) on the chart display yourself and set the value measured with a luminance meter to Min.lumi.

If a luminance meter is not available, set the value to 1/100 of the illuminance of the display surface. For example, when the illuminance is 300 Lux, set 3 cd/m².

Parameters

0.1 - 100 cd/m²

Initial value

4 cd/m²

- **Contrast**

Set the contrast value for the bar chart. Normally, set a constant value close to the maximum contrast displayed by Cont.Max. (For example, if Cont.Max is 35.2, set Contrast to 30.)

Contrast may change the image processing and affect the measurement results. For this reason, the contrast value must be constant. If a constant contrast is not available, the chart contrast used must be clearly stated in the MTF measurement results.

Parameters

2 - Cont.Max

Initial value

30

- **Cont.Max**

Displays the maximum value of contrast for the bar chart. This setting value varies depending on the following settings.

- Display Illuminance
- Max.lumi.
- Min.lumi.

In a high-light environment, a display with a large maximum luminance is required to achieve high contrast. In low-light environments, a display with a small minimum luminance (with minimal surface reflection) is required. However, the luminance range of a display is limited, and chart contrast is also subject to this limitation. For a typical PC monitor, the maximum contrast value that can be set in a 500 Lux environment is about 30. To perform measurements with constant contrast while changing lighting conditions, it is necessary to use the display with a large luminance range.

- **Try out button**

Displays checker chart and display number on the chart displays.
Used to check settings.



Figure 5-14 | Try out

5.3.3 Advanced Settings Tab

In the Advanced tab, make detailed settings for measurements.

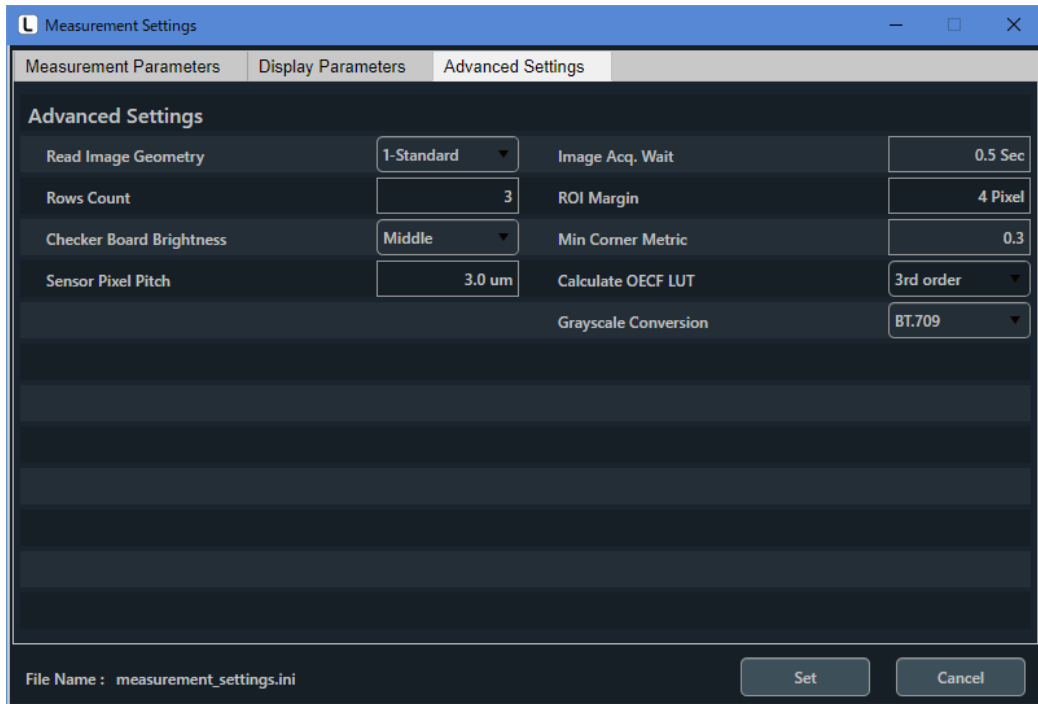

Figure 5-15 | Advanced Settings tab

- **Read Image Geometry**

Select the orientation setting of the camera image.

Parameters

1-Standard : No flip.
 2-Mirror : Flips left and right.

Initial value

1-Standard

- **Rows Count**

Set the number of vertical feature points in the checker chart. In the case of complex distortions, such as a camera performing viewpoint conversion, the distortion of the test chart may not be fully compensated for. In this case, set a value of 4 or higher.

Parameters

3 - 10

Initial value

3

- **Checker Board Brightness**

Select the brightness of the checker chart.

Parameters

Dark / Middle / Light

Initial value

Middle

- **Sensor Pixel Pitch**

Set the pixel pitch of the camera's image sensor.

The value set here is used to calculate the unit Lp/mm displayed in the MTF graph.

Parameters

0.1 – 100.0 um

Initial value

3.0 um

- **Image Acq. Wait**

Set the wait time between switching the test chart and taking the picture.

The appropriate value depends on the PC specifications, the display, and the camera resolution. For high-resolution cameras or camera image acquisition is slow, the switching of the test chart and the timing of shooting may be out of sync, in which case the wait time should be increased.

Parameters

0.5 - 2 Sec

Initial value

0.5 Sec

- **ROI Margin**

Set the margin for measuring the ROI.

For example, when set to 4 Pixel, the area inside 4 pixels of the ROI will be measured.

Parameters

0 - 10 Pixel

Initial value

4 Pixel

- **Min Corner Metric**

Set the Parameters for detecting feature points on the checker chart. The small value, the more feature points will be detected. If it is difficult to detect feature points on a checker chart, set a smaller value, and if the background is detected, set a larger value.

Parameters

0.1 - 0.7

Initial value

0.3

- **Calculate OECF LUT**

Select the approximate order of OECF. Normally, select 3rd order.

Parameters

1st order / 3rd order / 4th order

Initial value

3rd order

- **Grayscale Conversion**

Select the standard for converting RGB values to grayscale.

Parameters

BT.601 :	Luminance Calculation Formula [$Y=0.299R+0.587G+0.114B$]
----------	---

BT.709 :	Luminance Calculation Formula [$Y=0.213R+0.715G+0.072B$]
----------	---

Initial value

BT.709

5.4 Output Settings Menu

In Output Settings Menu, set the output data.

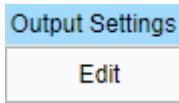

Figure 5-16 | Output Settings Menu

Selecting "Edit" opens the Output Settings Window, where you can set output data settings.

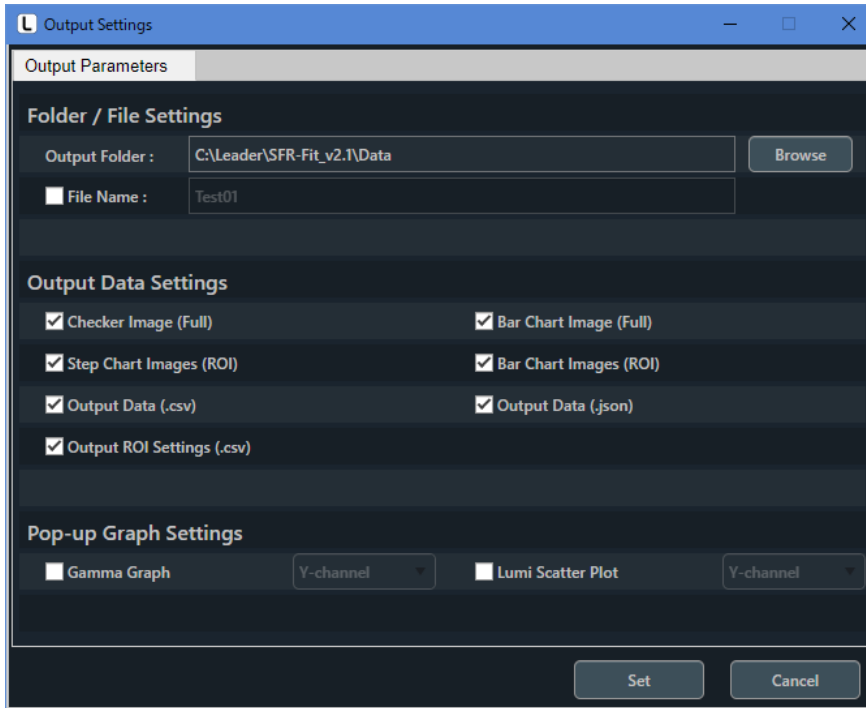

Figure 5-17 | Output Settings Window

- **Output Folder**

Set the data output folder with the Browse button.

Initial value

C:\Leader\SFR_Fit_v2.1\Data

- **File Name**

Set file and folder names for output data.

Parameters

- | | |
|-------|---|
| ON : | The file name and folder name will be the name you entered. Subsequent measurements will overwrite the output data. |
| OFF : | The file name and folder name will be "SFR-Fit_v2.1_YYYYMMDD_hhmmss". |

Initial value

OFF

- **Checker Image (Full)**

When turned ON, an image of the checker chart is output in png format. Initial value is ON.

The file name is

[Name set in File Name]_ChekerImage_n.png (n=1~9).

One file is output per display.

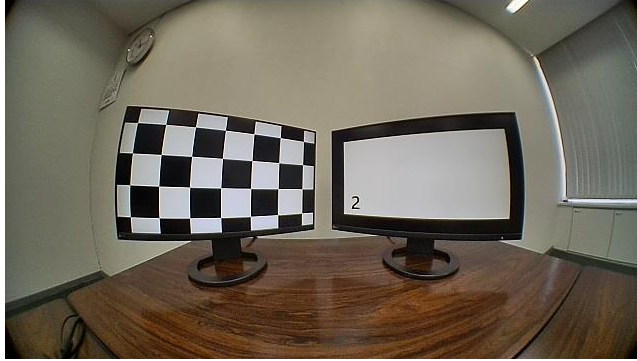

Figure 5-18 | Checker Image (Full)

- **Step Chart Images (ROI)**

When turned ON, only the ROI portion of the step chart image is output in png format.

Initial value is ON. When Chart Type in the Measurement Settings Menu is set to Single, no output is generated even if it is turned ON.

Files are saved in the "Step_Images_ROI" folder.

The file name is

[Display number]-[ROI number]_n.png (n=1~8).

Eight files are output for one ROI.

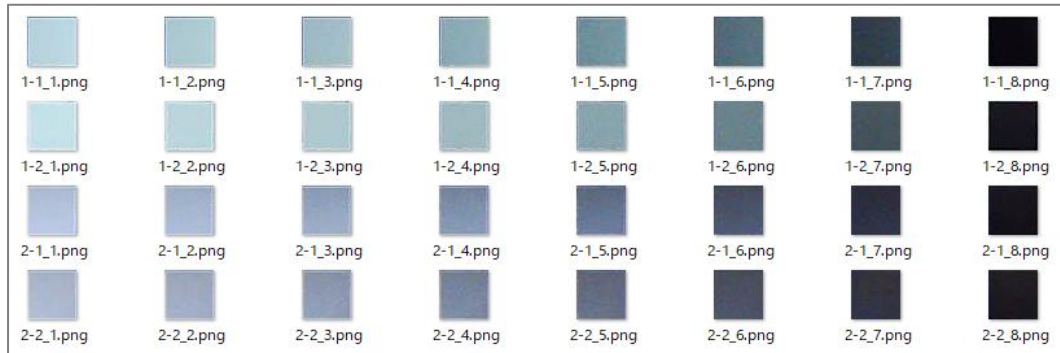

Figure 5-19 | Step Chart Images (ROI)

- **Output Data (.csv)**

When turned ON, measurement data is output in csv format.

The file name is

[Name set in File Name] _ [Display number] - [ROI number].csv

One file is output per ROI.

Software_Infomation						
Software_Name	SFR-Fit_v2.1					
Software_Version	2.100					
Date_Infomation						
Analyzed_Date	2022/6/29					
Analyzed_Time	9:56:36					
Setting_Files_Infomation						
Measurement_Settings_File_Name	--					
Camera_Settings_File_Name	--					
Measurement_Modes						
Image_Acquisition_Mode	Camera					
Chart_Type	Standard					
Measurement_Settings						
Maximum_Frequency [Cyc/Pixel]	0.65					
Minimum_Frequency [Cyc/Pixel]	0.05					
Display_Illuminance [Lux]	500					
MTF_Frequency [Cyc/Pixel]	0.167					
Measure_Points	10					
Advanced_Settings						
Read_Image_Geometry	1-Standard					
Rows_Count	3					
Checker_Board_Brightness	Middle					
Sensor_Pixel_Pitch [um]	3					
Image_Acq._Wait [Sec]	0.5					
ROI_Margin [Pixel]	4					
Min_Corner_Metric	0.3					
Calculate_OECF_LUT	3rd order					
Grayscale_Conversion	BT.709					
Camera_Information						
Camera_Name	HD USB Camera					
Camera_Width	1024					
Camera_Height	768					
Display_Settings						
Display_No	1					
Display_Selection	1					
Chart_Width	1920					
Chart_Height	1080					
Display_Gamma	2.2					
Display_Maximum_Luminannce	250					
Display_Minimum_Luminannce	4					
Chart_Contrast	30					
Required_relative_resolution	3.9					
Measured_relative_resolution_(minimum)	6.19					

5 Description of each Window

ROI_Settings						
ROI_No	1					
ROI_X_Position [Pixel]	512					
ROI_Y_Position [Pixel]	384					
ROI_Size [Pixel]	38					
ROI_Angle [deg]	5					
SFR_Plot_Data(Contrast)						
Freq [cyc/pixel]	Freq [LW/PH]	Freq [LP/mm]	Y_channel	R_channel	G_channel	B_channel
0.05	76.8	16.7	0.958	0.968	0.946	0.868
0.117	179.7	39	0.883	0.936	0.868	0.761
0.183	281.1	61	0.833	0.881	0.817	0.741
0.25	384	83.3	0.785	0.806	0.784	0.711
0.317	486.9	105.7	0.771	0.768	0.773	0.683
0.383	588.3	127.7	0.685	0.676	0.685	0.617
0.45	691.2	150	0.552	0.542	0.555	0.468
0.517	794.1	172.3	0.437	0.429	0.432	0.416
0.583	895.5	194.3	0.314	0.297	0.305	0.368
0.65	998.4	216.7	0.199	0.184	0.192	0.23
Frequency_to_MTF [%]						
Freq [cyc/pixel]	Freq [LW/PH]	Freq [LP/mm]	Y_channel [%]	R_channel [%]	G_channel [%]	B_channel [%]
0.167	256.5	55.7	84.5	89.6	82.7	74.7
MTF_to_Frequency [cyc/Pixel]						
MTF	Y_channel [cyc/Pixel]	R_channel [cyc/Pixel]	G_channel [cyc/Pixel]	B_channel [cyc/Pixel]		
MTF50	0.48	0.475	0.48	0.432		
MTF30	0.591	0.581	0.586	0.622		
MTF20	0.649	0.64	0.645	NaN		
MTF10	NaN	NaN	NaN	NaN		
MTF_to_Frequency [LW/PH]						
MTF	Y_channel [LW/PH]	R_channel [LW/PH]	G_channel [LW/PH]	B_channel [LW/PH]		
MTF50	737.3	729.6	737.3	663.6		
MTF30	907.8	892.4	900.1	955.4		
MTF20	996.9	983	990.7	NaN		
MTF10	NaN	NaN	NaN	NaN		
MTF_to_Frequency [LP/mm]						
MTF	Y_channel [LP/mm]	R_channel [LP/mm]	G_channel [LP/mm]	B_channel [LP/mm]		
MTF50	160	158.3	160	144		
MTF30	197	193.7	195.3	207.3		
MTF20	216.3	213.3	215	NaN		
MTF10	NaN	NaN	NaN	NaN		
OECF_Data [digit]						
Patch_No	Mean_Y_Level [digit]	Mean_R_Level [digit]	Mean_G_Level [digit]	Mean_B_Level [digit]		
1	253.9	250.9	254.9	255		
2	253	247.4	254.6	255		
3	246.9	226.6	252.2	255		
4	232.2	212	236.3	252.2		
5	211.6	191.8	215.3	234.9		
6	182.4	164.1	185.7	204		
7	125.7	106.1	128.6	154.3		
8	18.5	19.5	17.2	29.4		

Figure 5-20 | Output Data (.csv)

● **Output ROI Settings (.csv)**

When turned ON, ROI settings are output in csv format. Initial value is ON.

The file name is

[Name set in File Name]_ROI.csv

Outputs all ROI settings in one file.

Display No.	ROI No.	X Position	Y Position	Size	Angle	Camera Width	Camera Height
↓	↓	↓	↓	↓	↓	↓	↓
D	R	X	Y	S	A	W	H
1	1	333	330	40	5	1280	720
1	2	509	330	40	5	1280	720
2	1	737	330	40	5	1280	720
2	2	903	330	40	5	1280	720

Figure 5-21 | Output ROI Settings (.csv)

● **Bar Chart Image (Full)**

When turned ON, an image of the final bar chart or Single Chart is output in png format. Initial value is ON.

The file name is

[Name set in File Name]_BarImageFull.png

Chart Type = Standard



Figure 5-22 | Bar Chart Image (Full)

Chart Type = Single



Figure 5-23 | Bar Chart Image (Full)

- **Bar Chart Images (ROI)**

When turned ON, bar chart or Single Chart images are output in png format for the ROI portion only. Initial value is ON.

When the Chart is Standard, the files are saved in the "Bar_Images_ROI" folder.

The file name is

[Display number]-[ROI number]_n.png (n=1~20)

Files of 3 to 20 points (depending on Measure Points) are output for one ROI.

Chart Type = Standard

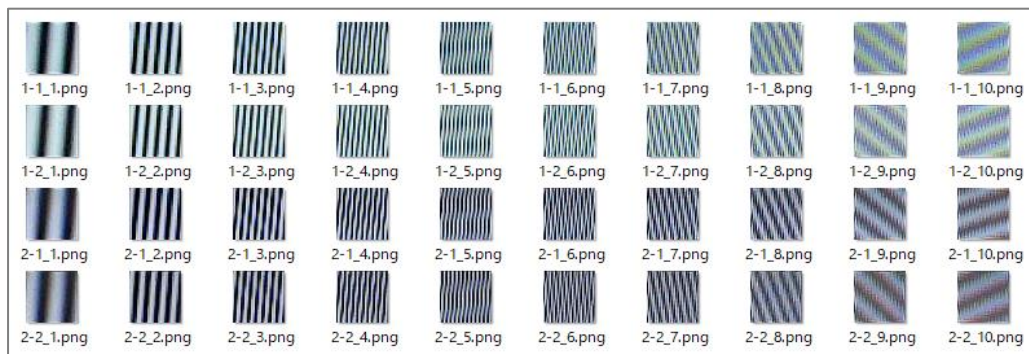

Figure 5-24 | Bar Chart Images (ROI)

When the Chart Type is Single, the files are saved in the "Single_Images_ROI" folder.

The file name is

[Display number]-[ROI number].png

One file is output per ROI.

Chart Type = Single



Figure 5-25 | Bar Chart Images (ROI)

- **Output Data (.json)**

When turned on, measurement data is output in json format. Initial value is ON.

Used to display previously measured data in SFR Viewer.

The file name is

[Name set in File Name].json

- **Gamma Graph**

When turned ON, the gamma graph is displayed in a separate window at the end of measurement. Initial value is OFF.

When Y-channel is selected, only the luminance signal is displayed; when All-channel is selected, graphs of luminance, R, G, and B signals are displayed.

Please refer to "5.9.1 Gamma Graph" for details.

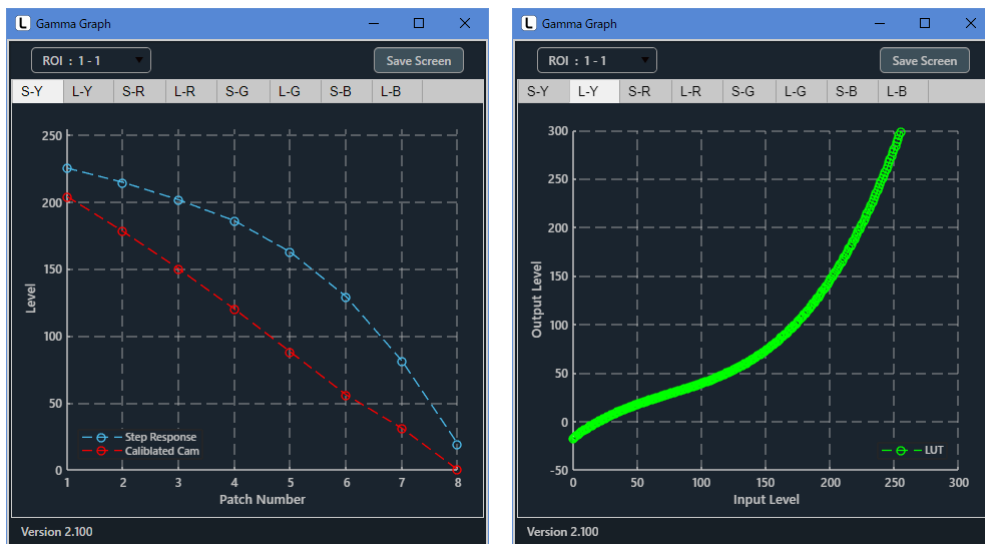

Figure 5-26 | Gamma Graph

- **Lumi Scatter Plot**

When turned ON, the sampling waveform of the bar chart is displayed in a separate window at the end of measurement.

When Y-channel is selected, only luminance signals are displayed; when All-channel is selected, graphs of luminance, R, G, and B signals are displayed. Please refer to "5.9.2 Lumi Scatter Plot" for details.

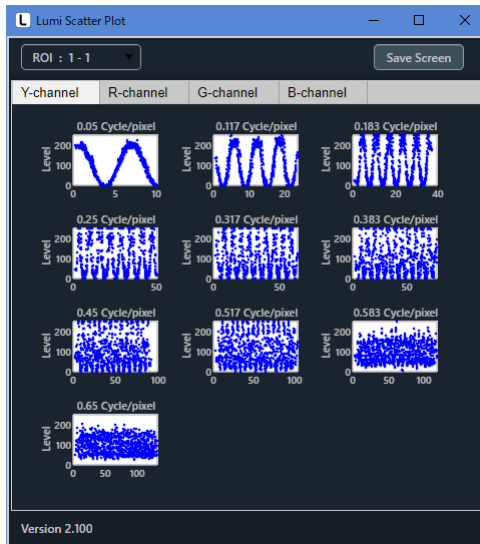

Figure 5-27 | Lumi Scatter Plot

- **Set button**

Check the settings and close the Output Settings Window.

- **Cancel button**

Close the Output Settings Window without applying the settings.

5.5 Utilities Menu

The Utilities Menu displays useful tools for measurement.

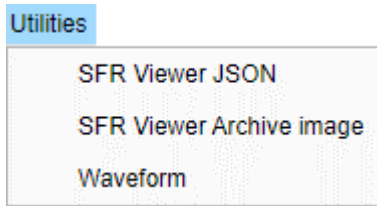

Figure 5-28 | Utilities Menu

SFR Viewer JSON :	By loading a json format file, it displays data measured in the past. Since it works with only one file, it is useful when you want to check the MTF graphs easily.
SFR Viewer Archive image :	By loading a folder containing set of data, it displays data measured in the past. Although multiple files are required for operation, pop-up graphs as well as MTF graphs can be checked, which is useful when you want to check detailed data.
Waveform :	Displays the waveform of the camera image. This is useful for setting the illumination level of the display.

5.5.1 SFR Viewer JSON

SFR Viewer JSON Window can display previously measured data by reading a json format file. To display the data measured on the main Window in SFR Viewer JSON Window, follow the steps below.

1 Turn on "Output Data (.json)" in the Output Settings Menu of the Main Window.

Turn on "Bar Chart Image (Full)" if necessary. Although the MTF graph can be displayed without this file, it is useful for checking the ROI since it displays the image as it was taken.

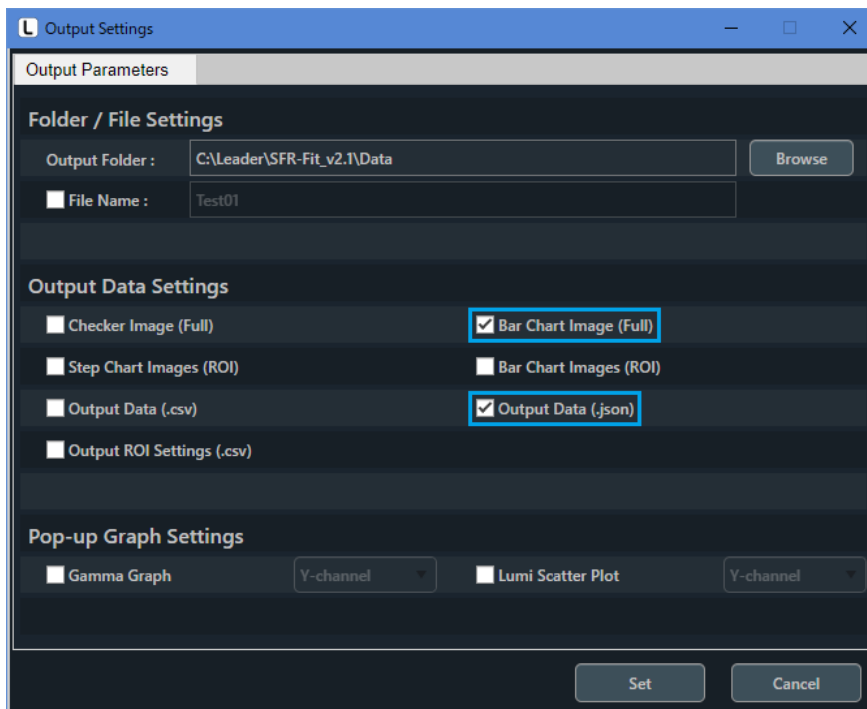

Figure 5-29 | Output Settings Window

2 Take measurements on the main window.

3 Select "SFR Viewer JSON" in the Utilities Menu of the Main Window.

The SFR Viewer JSON Window will open.

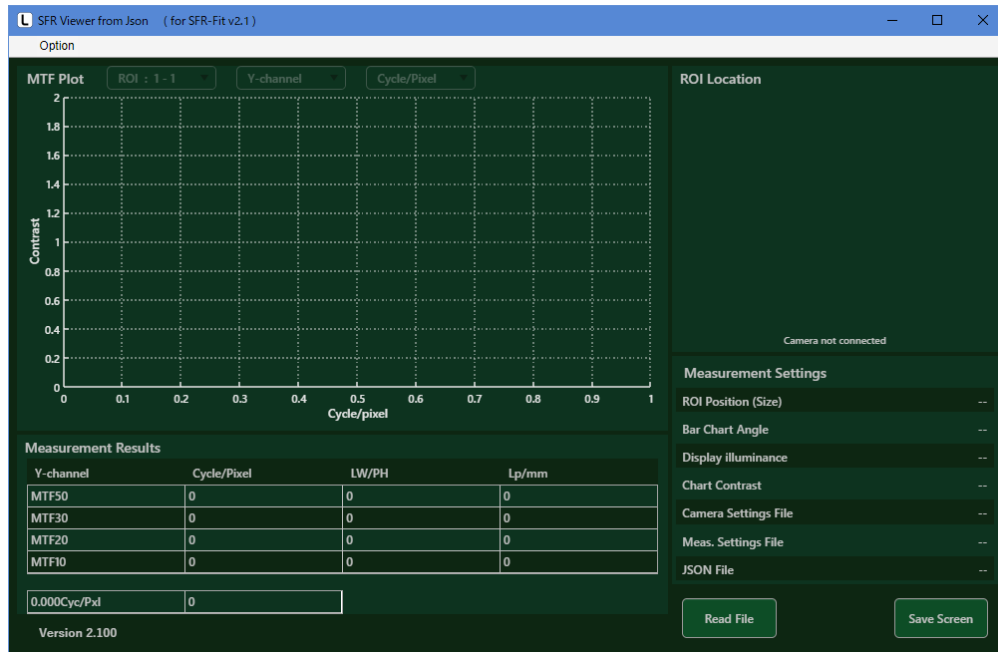

Figure 5-30 | SFR Viewer JSON Window

4 Click the Read File button, select the json file, and click the Open button.

By default, the json file is saved in "C:¥Leader¥SFR-Fit_v2.1¥Data¥SFR-Fit_v2.1_YYYYMMDD_hhmmss]".

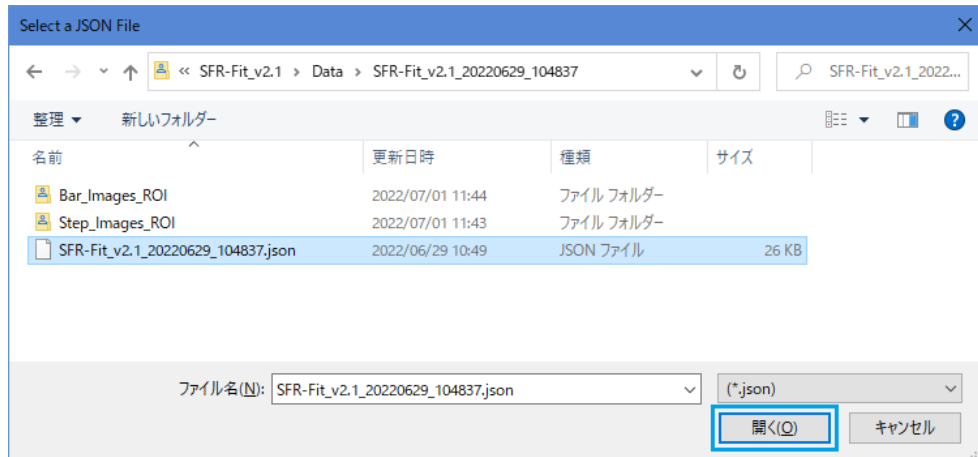

Figure 5-31 | Select a JSON File

5 Description of each Window

When the json file is read correctly, the MTF curve will be displayed.
As with the Main Window, you can switch between ROI, channels, and units.

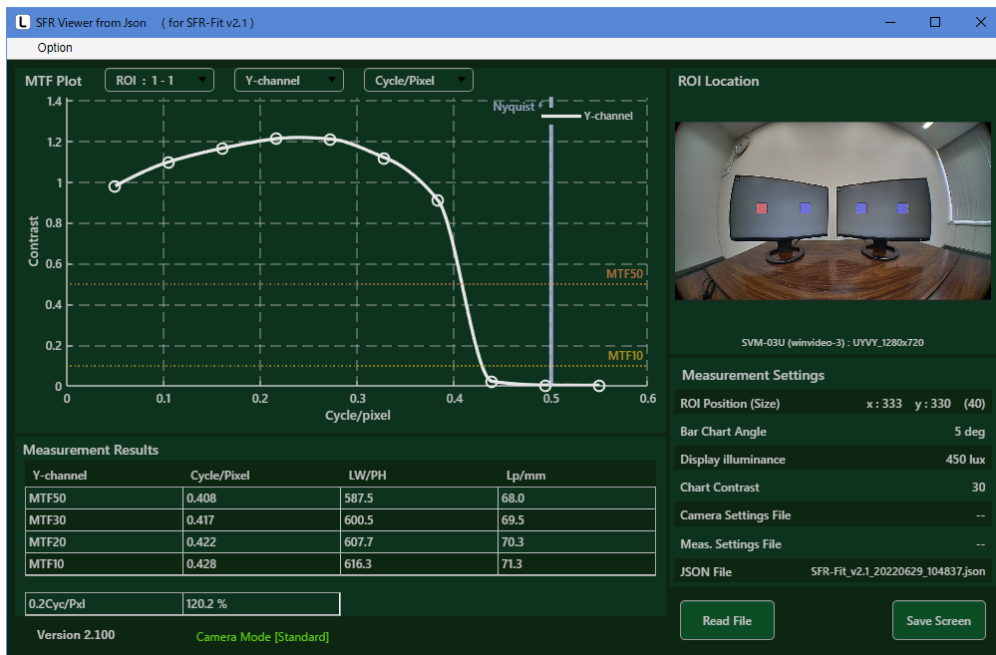

Figure 5-32 | SFR Viewer JSON Window

The ROI Location in the upper right corner of the Window displays the camera image when the bar chart image file "`*_BarImageFull.png`" exists at the same level as the json file. If there is no file, the background is displayed in gray as shown below.

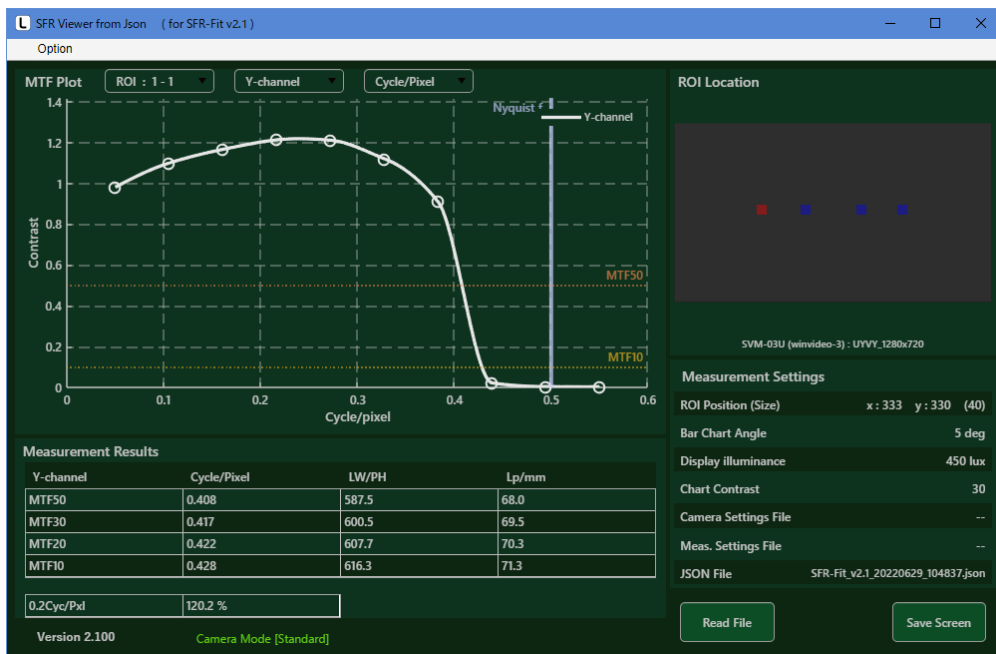

Figure 5-33 | SFR Viewer JSON Window

5.5.2 SFR Viewer Archive Image

The SFR Viewer Archive image Window can display previously measured data by loading the folder containing the complete set of data.

To display the data measured in the Main Window in the SFR Viewer Archive image window, follow the steps below.

- 1 In the Output Settings menu on the main window Turn on "Step Chart Image (ROI)", "Bar Chart Image (ROI)" and "Output Data (.json)".**

Turn on "Bar Chart Image (Full)" if necessary. The MTF graph can be displayed without this file, but the file is useful for checking the ROI because the image at the time of shooting can be displayed.

Step Chart Images (ROI)" is not necessary when Chart Type is Single.

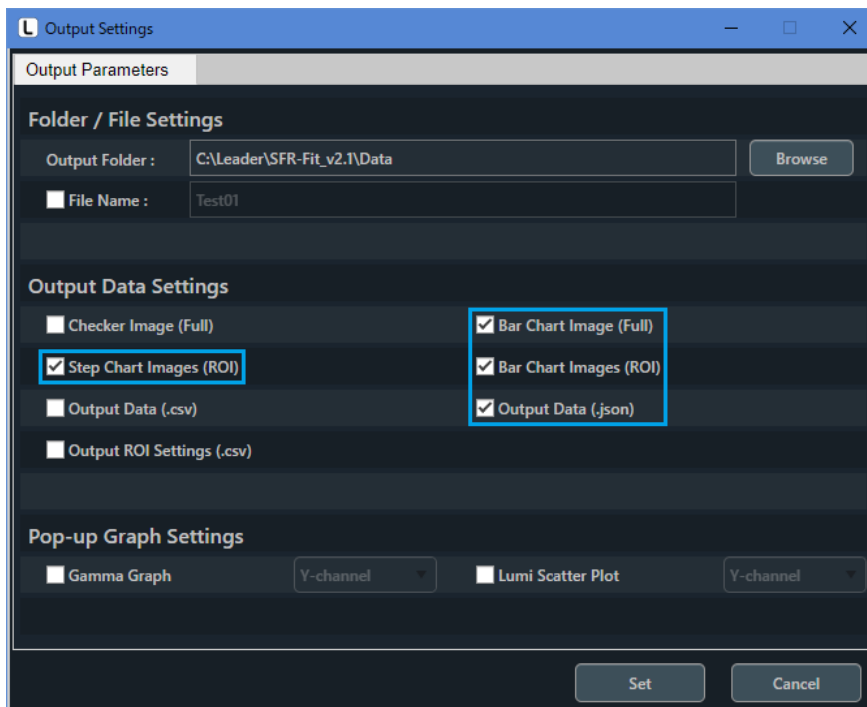

Figure 5-34 | Output Settings Window

- 2 Take measurements on the main window.**

3 Select "SFR Viewer Archive image" in the Utilities Menu of the Main Window.

The SFR Viewer Archive image Window will open.

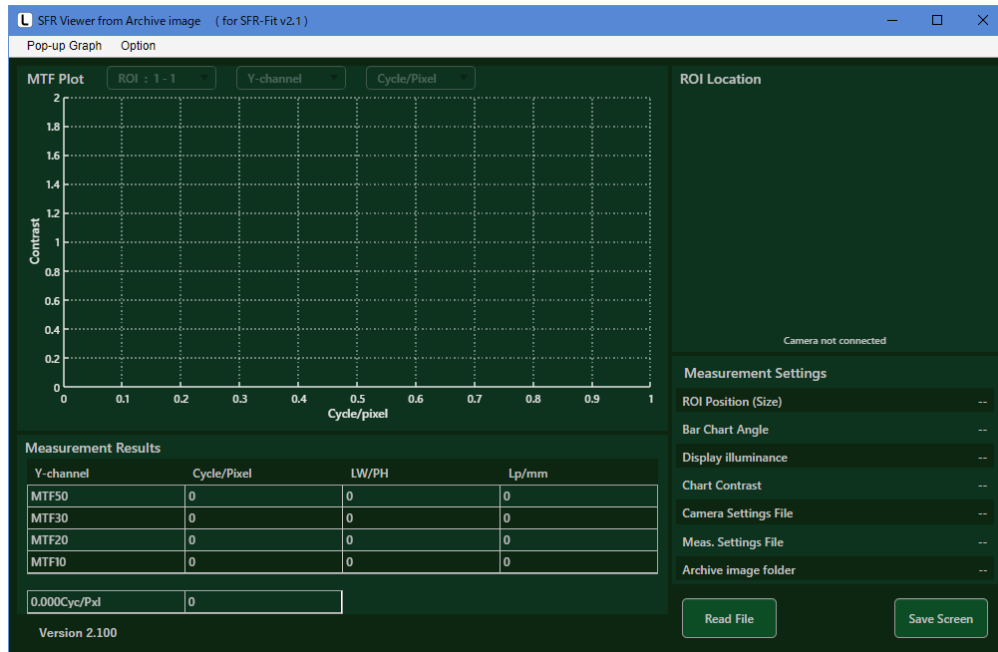

Figure 5-35 | SFR Viewer Archive image Window

4 Turn on "Gamma Graph" and "Lumi Scatter Plot" in the pop-up graph menu, if necessary.

If these are turned on, the pop-up graph can be displayed when displaying the MTF graph.

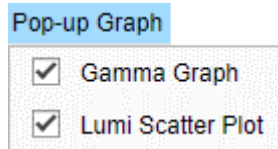

Figure 5-36 | Pop-up Graph Menu

5 Click the Read File button, select the data folder, and click the Select Folder button.

By default, the data folder is saved in "C:¥Leader¥SFR-Fit_v2.1".

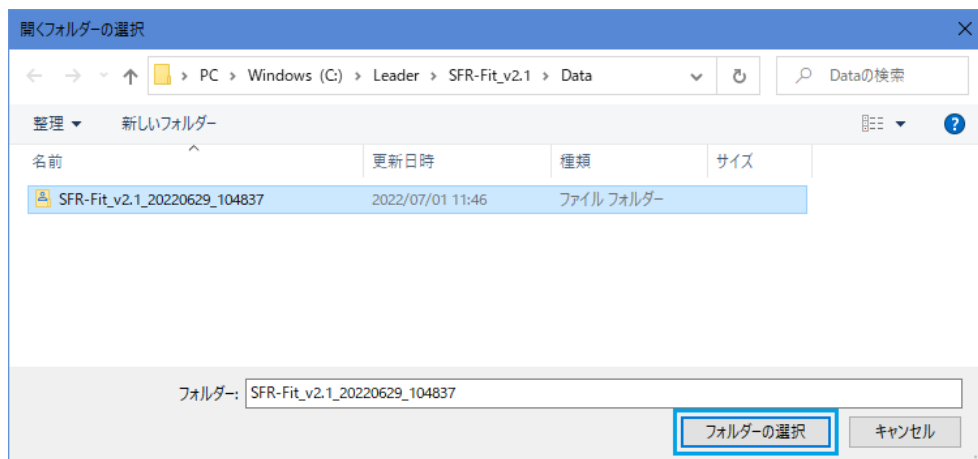

Figure 5-37 | Select a folder to open

5 Description of each Window

When the data folder is loaded correctly, the MTF curve will be displayed.

As with the Main Window, you can switch between ROI, channels, and units.

The ROI Location in the upper right corner of the Window displays the camera image when the bar chart image file "**_BarImageFull.png*" is available. If the file is not present, the background is displayed in gray.



Figure 5-38 | SFR Viewer Archive image Window

When Pop-up Graph is turned on in step 4, the pop-up graph is simultaneously displayed in a separate window.

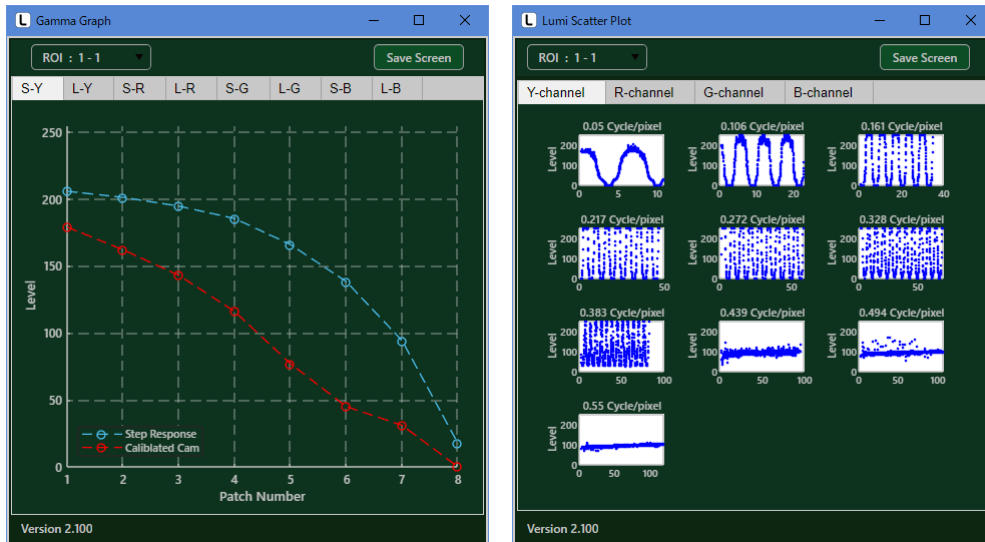

Figure 5-39 | pop-up graph

5.5.3 Waveform

The Waveform Window displays the camera image in the upper half and the waveform of the selected line in the lower half.

This window cannot be displayed when the Image Acquisition Mode is File.

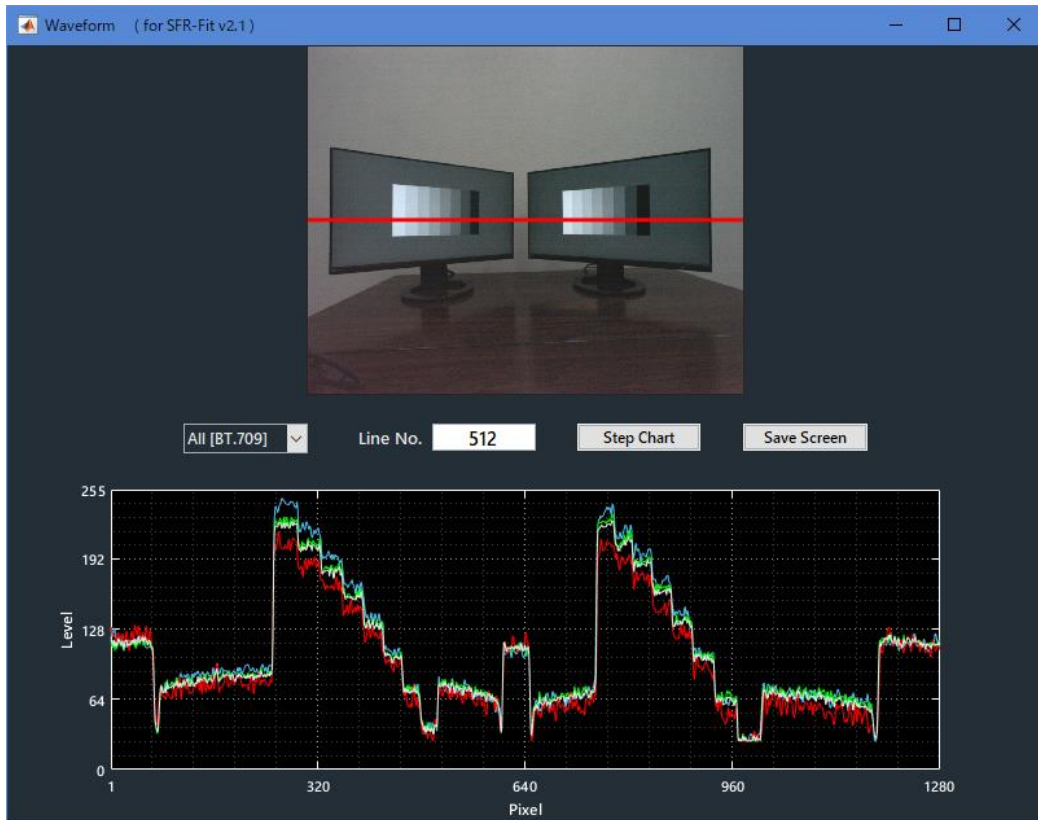

Figure 5-40 | Waveform Window

- **Channel Selection**

Use the pull-down menus below to select the channels to be displayed in the graph. The default values are all [BT.709]. Selecting All to overlay all channels.

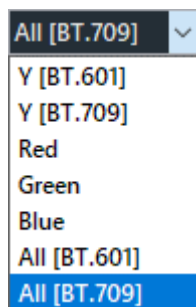

Figure 5-41 | Channel Selection

- **Line Selection**

Line Selection can be dragging the red line or typing directly into Line No.

- **Step Chart Display**

The Step Chart button displays a step chart on all connected displays. This is useful for setting the illuminance of the display.

Set the illuminance of the display so that the step chart section is not saturated.

- **Save Window**

The Save Screen button saves the current window in png, jpg, tif, or pdf format.

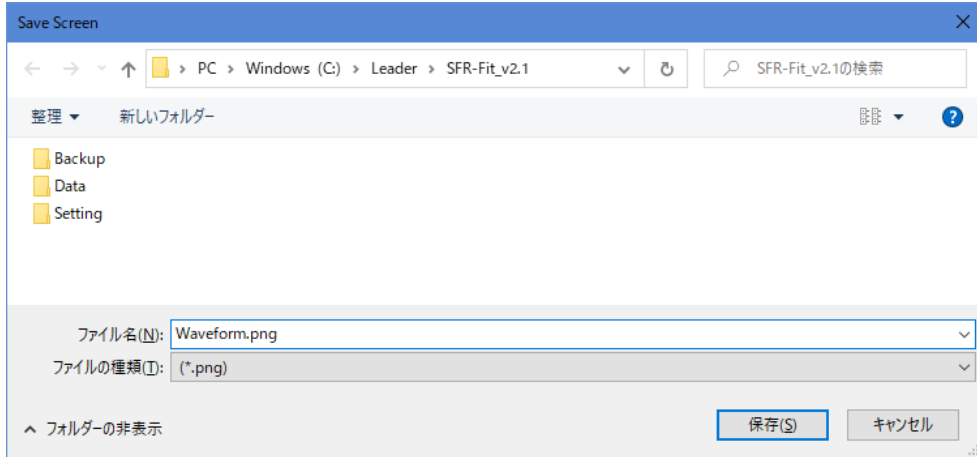

Figure 5-42 | Save Window

5.6 Option Menu

The Option Menu displays tooltip settings and information about SFR-Fit.

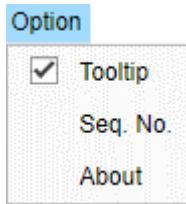

Figure 5-43 | Option Menu

- **Tooltip**

When turned ON, a hint for operation is displayed by mouse-over on each button. Initial value is ON.

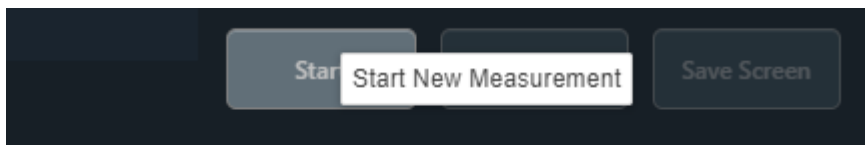

Figure 5-44 | Tooltip display

- **Seq. No.**

When turned ON, the progress of the measurement is displayed at the bottom of the main Window. Used for debugging.

Initial value is OFF.



Figure 5-45 | Tooltip display

- **About**

Displays information about SFR-Fit.

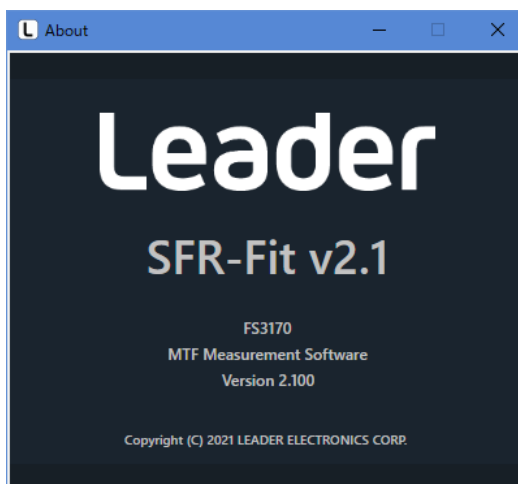

Figure 5-46 | About Window

5.7 MTF Plot Window

The MTF Plot Window displays an MTF graph after the measurement.

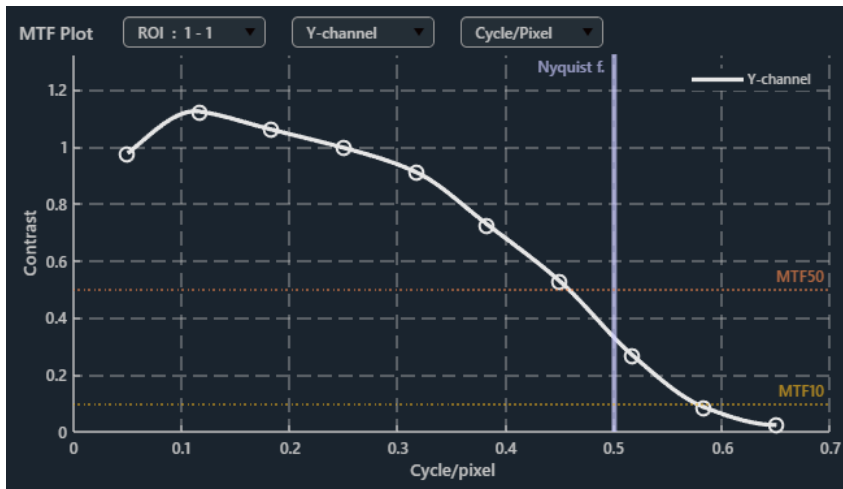

Figure 5-47 | MTF Plot Window

- **ROI Selection**

Use the pull-down menus below to select the ROI to be displayed on the graph.

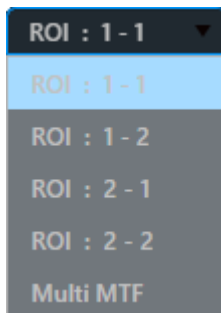

Figure 5-48 | ROI Selection

Selecting Multi MTF in the ROI selection opens Multi MTF Window in a separate window. Displays the spatial frequency of the luminance signal at MTF 50 and MTF 10 with the channels and units selected in the MTF Plot Window.

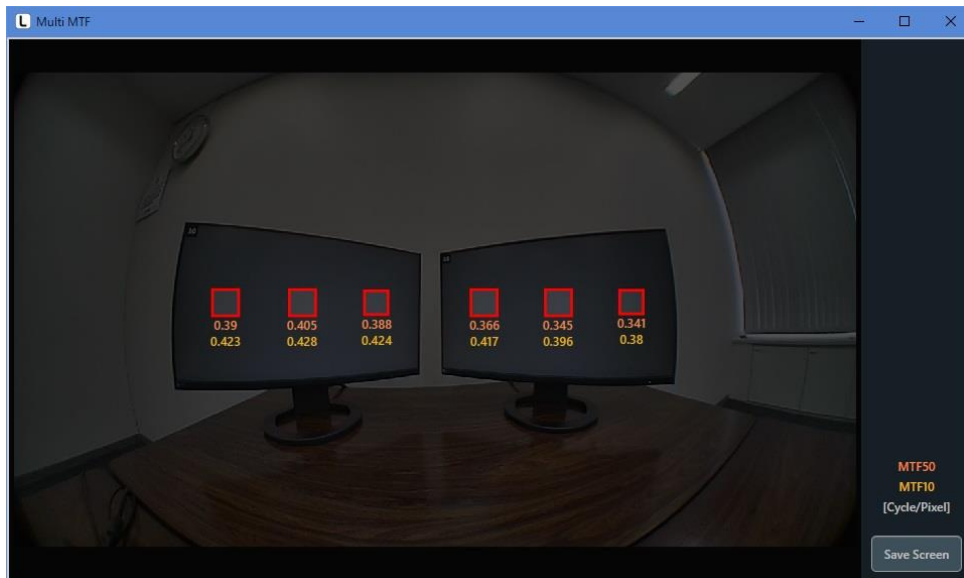

Figure 5-49 | Multi MTF Window

The Save Screen button saves the current window in png, jpg, tif, or pdf format.

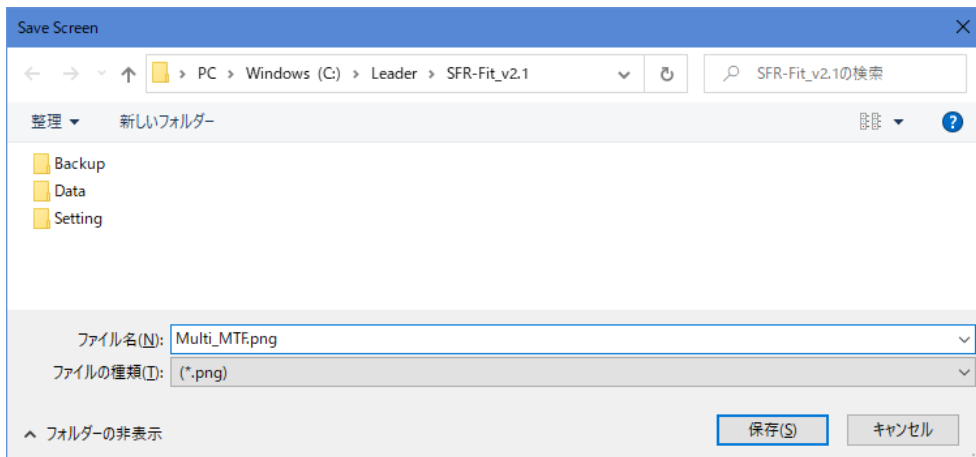

Figure 5-50 | Save Window

- **Channel Selection**

Use the following pull-down menu to select the channel to be displayed on the graph. The default value is Y channel.

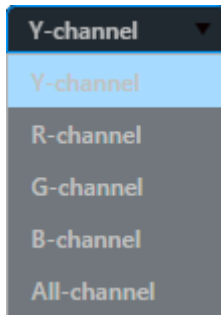

Figure 5-51 | Channel Selection

When you select All-channel, all channels will be displayed on top of each other.

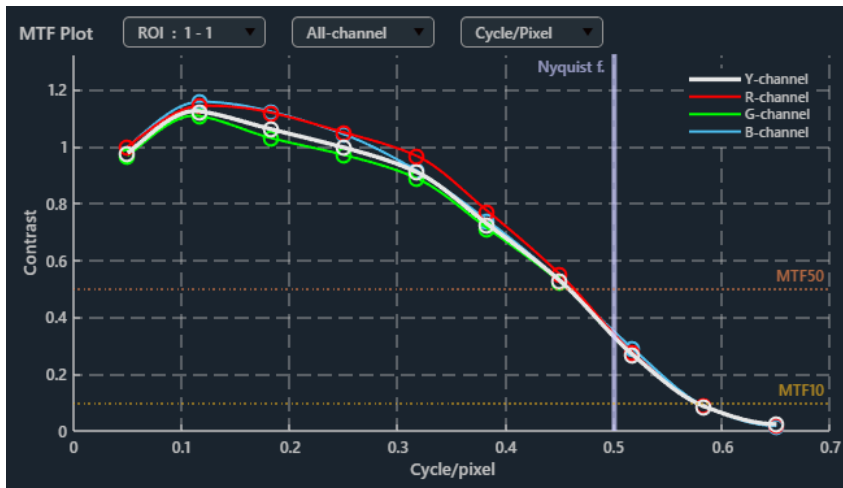

Figure 5-52 | All-channel

● **Unit selection**

In the pull-down menu below, select the unit of spatial frequency. The default value is Cycle/Pixel.

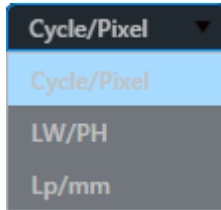

Figure 5-53 | Unit selection

Cycle/Pixel :	Indicates the number of Cycles of the pattern displayed per Pixel.
LW/PH :	Indicated by Line Wise per Picture Height.
Lp/mm :	Indicated by Line Pairs per Picture Height. The sensor pixel pitch must be entered in the measurement setting menu.

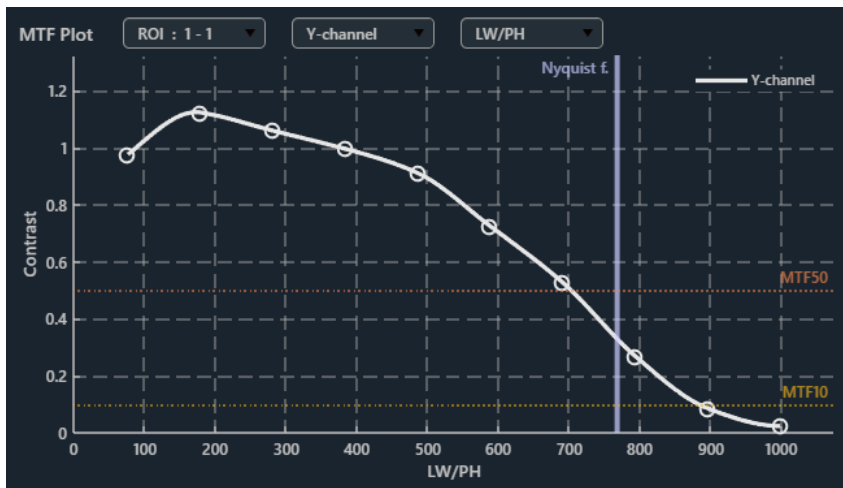

Figure 5-54 | Unit Selection (LW/PH)

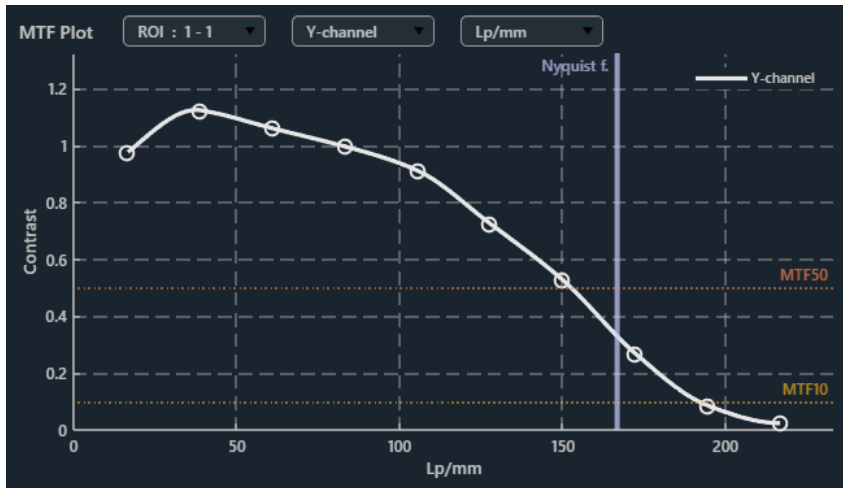

Figure 5-55 | Unit Selection (Lp/mm)

- **Data Hint Display**

By mouse over the graph, displays the interpolated measurements in black.

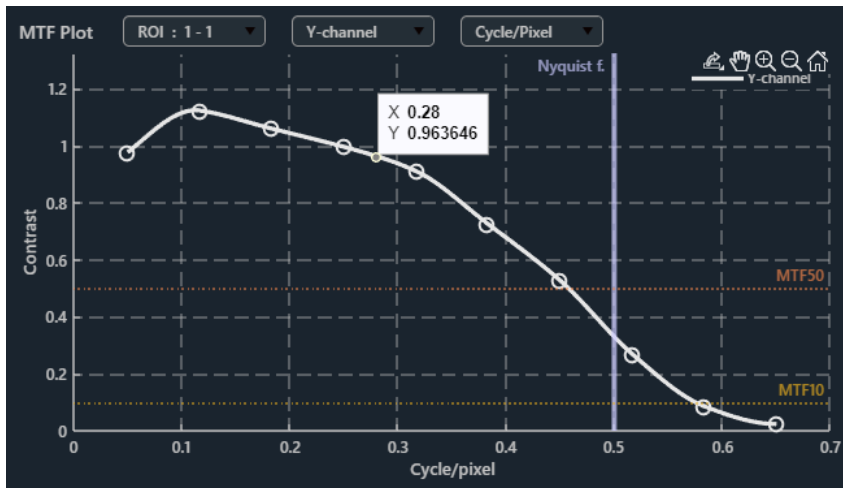

Figure 5-56 | Data Hint Display 1

By clicking on the graph, the measured value is always displayed. In this case, the measured value is light blue. Multiple measurements can also be displayed.

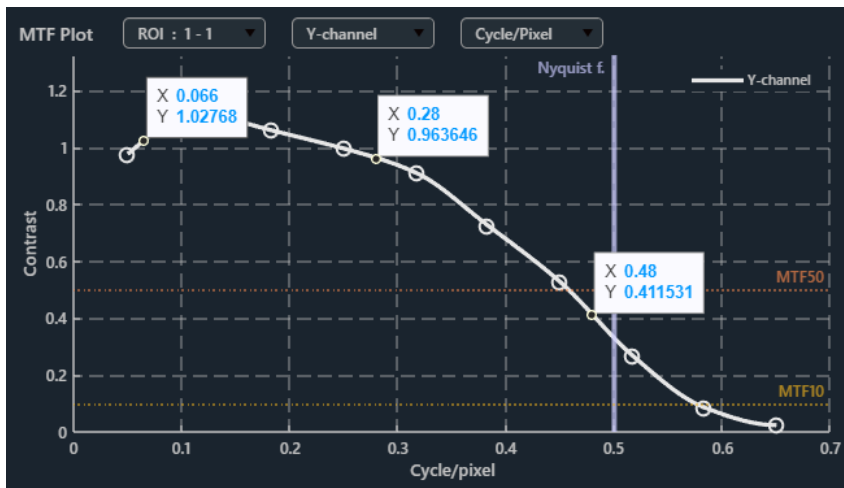

Figure 5-57 | Data Hint Display2

Right-click on the light blue measurement to display the Menu.

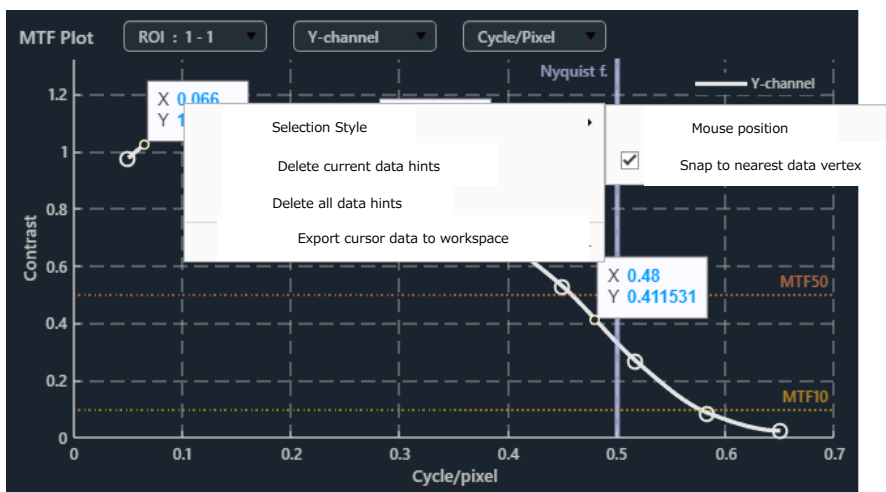

Figure 5-58 | Data Hint Display3

-
- Select Style : Selects the format for displaying the measured values.
 - Delete Current Data Hint Display : Deletes the measured values when right-clicked.
 - Delete all data hints : Delete all measurements.
 - Export cursor data to workspace : Not used in SFR-Fit
-

5.8 ROI Setting Window

The ROI Setting screen is displayed after pressing the Start button on the main screen. In this window, set the ROI position, size, and bar angle. The ROI should be placed within the active area(bright rectangle).

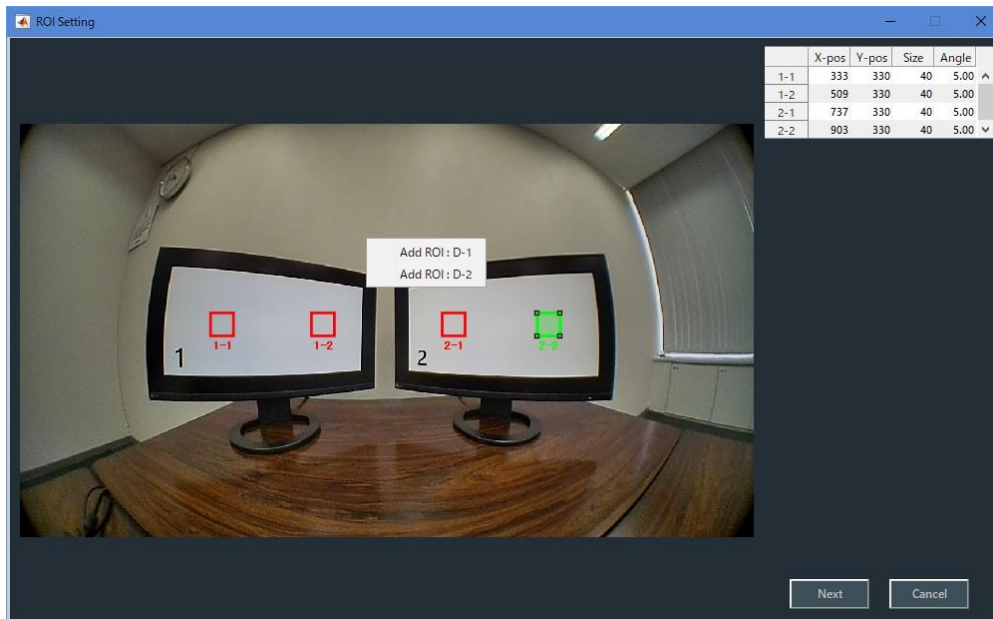

Figure 5-59 | ROI Setting Window

- **ROI Selection**

To select a ROI, double-click on it.

Normally, ROIs are displayed in red, but turn green when selected; to edit or delete a ROI, select it and then do so.

- **Add ROI**

To add an ROI, right-click and select the display number following Add ROI. A ROI is added at the right-clicked position and ROIs are numbered in the format "Chart Display number - ROI number".

- **Deletion of ROI**

To delete a ROI, right-click when the ROI is selected and choose Delete.

- **Move ROI**

To move a ROI, drag it when it is selected.

- **Resize ROI**

To change the size of the ROI, drag the four corners when the ROI is selected.

When Chart Type in the Measurement Settings Menu is Single, the ROI size is fixed at 81. It cannot be changed.

● Editing ROI

ROIs can also be moved and resized numerically.

To edit a ROI, right-click with the ROI selected and select "Edit."

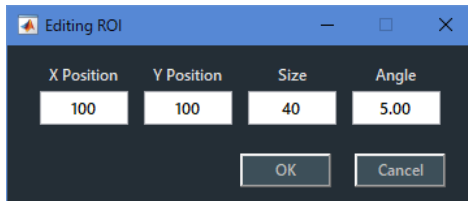

Figure 5-60 | Editing ROI

X Position :	Set the X coordinate of the upper left corner of the ROI in Pixel. Left end is set as 1.
Y Position :	Set the Y coordinate of the upper left corner of the ROI in Pixel. The top edge is set to 1.
Size :	Set the length of one side of the ROI in Pixel. Initial value is 5% of the camera's Picture Height. When Chart Type in the Measurement Settings Menu is Single, it is fixed at 81. It cannot be changed.
Angle :	Set the bar chart angle in the range of -180.00 to 180.00 deg. Initial value is 5.00 deg.

About Angle

Angle is the angle of the bar chart. When set to 0deg, the bar chart is displayed vertically and the horizontal resolution is measured.

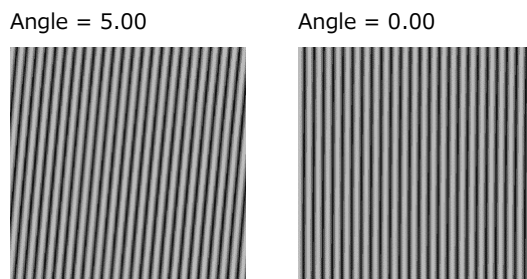

Figure 5-61 | Angle

Also, the angle of the bar chart does not depend on the placement of the chart display. For example, if the chart display is tilted and set to 0.00 deg, the bar chart will still be displayed vertically.



Figure 5-62 | Chart Display

Depending on the combination of Angle and measurement frequency, there may be insufficient sampling points and measurement may not be possible. (0.5 Cyc/Pixel at 0.00 deg, 0.707 Cyc/Pixel at 45.00 deg, etc.)

In this case, the error message will be displayed, so please change one of the following parameters.

- Angle : Bar chart angle
- Maximum Frequency : Maximum frequency measurement range
(Set in Measurement Settings Menu)
- Minimum Frequency : Minimum value of frequency measurement range
(Set in Measurement Settings Menu)
- Measure Points : Number of measurement points
(Set in Measurement Settings Menu)

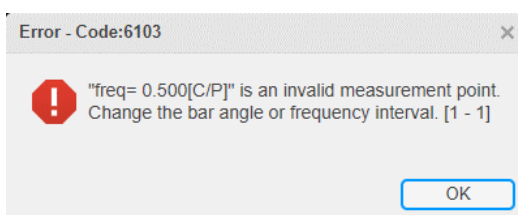

Figure 5-63 | Error Messages

- **Next button**

Check the settings and start measurement. After setting the ROI, do not move the camera and the chart display until the measurement is completed.

- **Cancel button**

Close the ROI Setting Window without applying the settings.

5.9 Pop-up Graphs

When the Pop-up Graph Settings on the Output Settings Window is turned on, two types of graphs are displayed in a separate window when the measurement is completed.

In addition, the SFR Viewer Archive image Window can display two types of graphs as well by turning on Pop-up Graph and then loading the file.

[Reference] 「5.4 Output Settings Menu」 「5.5.2 SFR Viewer Archive image」

5.9.1 Gamma Graph

The Gamma Graph Window displays the step response and LUT (Look Up Table) for the selected ROI.

Step Response displays Step Response in blue and Calibrated Cam in red.

The horizontal axis is the patch number of the step chart, with 1 corresponding to the brighter chart and 8 to the darker chart. The vertical axis is the brightness level.

The step response represents the OECF of the camera, and is normal when the graph shows a downward rightward trend.

If Patch 1 is at 255, or if Patches 1-3 have the same value, a white-out has occurred.

If the luminance levels of the patches are interchanged, the exposure may have changed during the measurement.

Also, if patch 8 has more than 50, the brightness of the chart background may not be appropriate.

Calibrated Cam represents the OECF of the camera after linear correction, and is normal when it is a linear, right-shouldered graph.

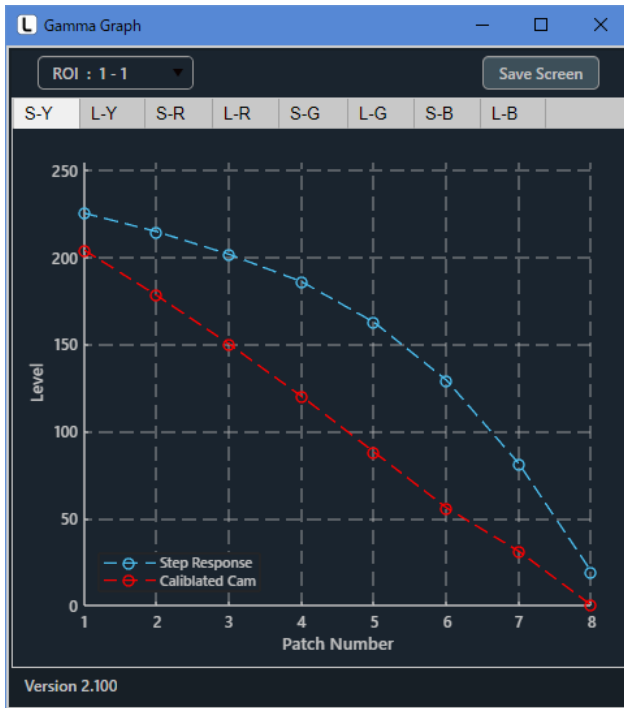

Figure 5-64 | Step response

The LUT displays a graph for linearizing the OECF of the camera.

The horizontal axis is the input luminance and the vertical axis is the output luminance (luminance after linear correction).

If the graph is a right ascending curve, it is normal.

If the graph is a V or U shape, the brightness of the chart background may not be appropriate.

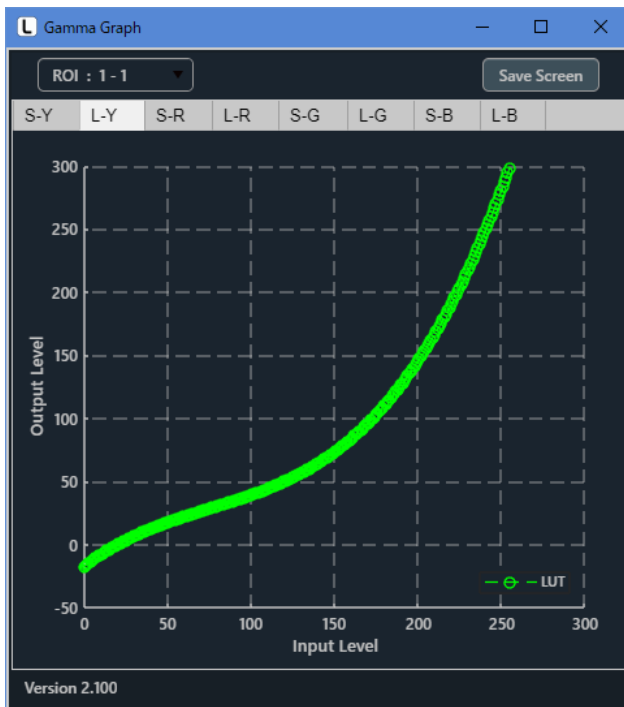

Figure 5-65 | LUT

- **ROI Selection**

Use the pull-down menus below to select the ROI to be displayed on the graph.

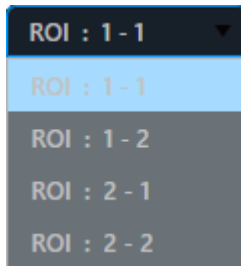

Figure 5-66 | ROI Selection

- **Save Window**

The Save Window button saves the selected graph in png, jpg, tif, or pdf format.

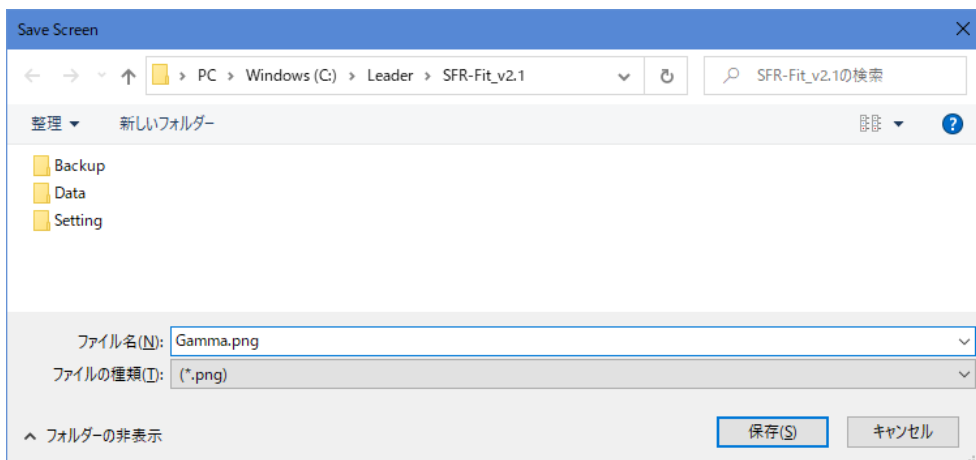

Figure 5-67 | Save Window

- **Graph Switching**

Switch tab to select the graph type and channel.

The RGB signal graph can be selected when All-channel is selected in the Output Settings Window. However, the SFR Viewer Archive image Window displays all channels.

S-Y :	Displays the step response of the luminance signal.
L-Y :	Displays the LUT of the luminance signal.
S-R :	Displays the step response of the R signal. (When All-channel is selected)
L-R :	Displays the LUT for the R signal. (When all-channel is selected)
S-G :	Displays the step response of the G signal. (When all-channel is selected)
L-G :	Displays the LUT of the G signal. (When all-channel is selected)
S-B :	Displays the step response of the B signal. (When all-channel is selected)
L-B :	Displays the LUT of the B signal (when all-channel is selected).

5.9.2 Lumi Scatter Plot

The Lumi Scatter Plot Window displays sampled waveforms for bar charts of the selected ROI. The horizontal axis is sampling points and the vertical axis is the luminance level after linearization.

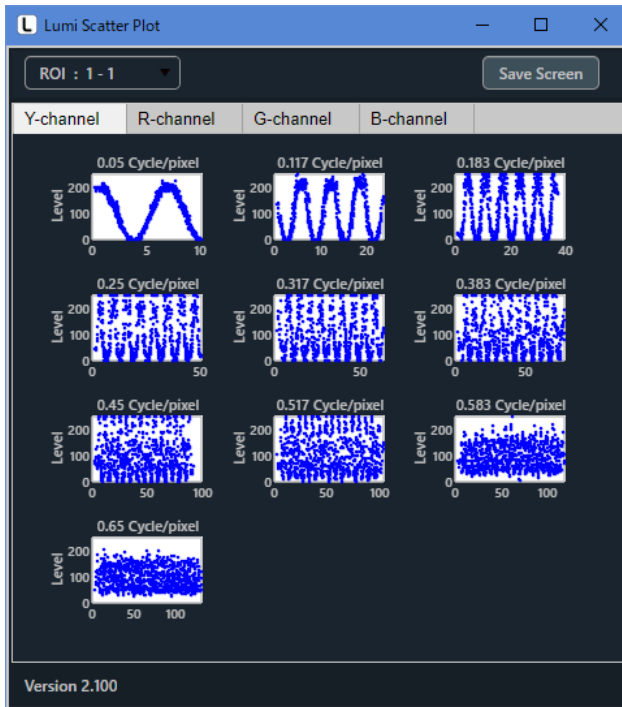

Figure 5-68 | Lumi Scatter Plot Window

When Chart Type is Single, the relationship between a Single Chart and a graph is as follows.

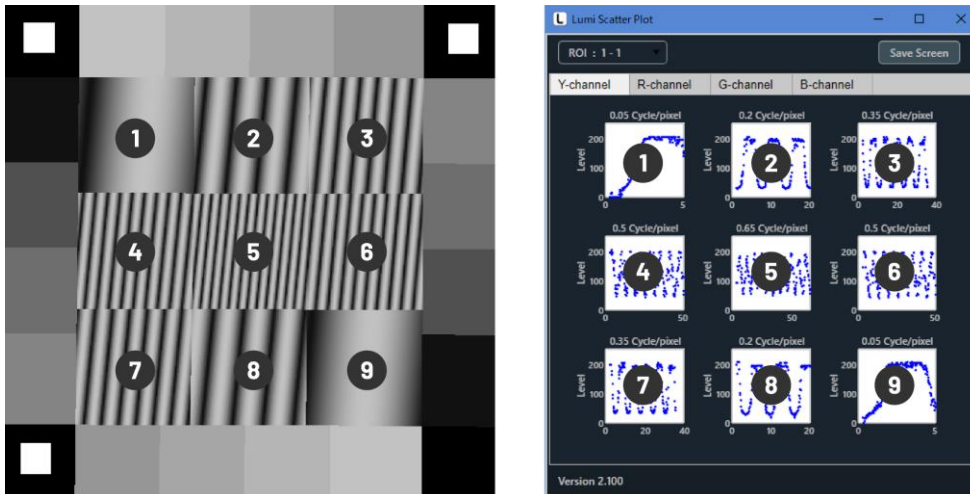

Figure 5-69 | Lumi Scatter Plot Window

- **ROI Selection**

Use the pull-down menus below to select the ROI to be displayed on the graph.

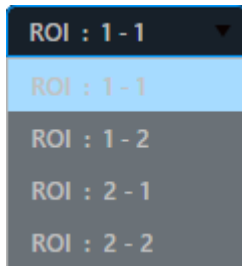

Figure 5-70 | ROI Selection

- **Save Window**

The Save Window button saves the selected graph in png, jpg, tif, or pdf format.

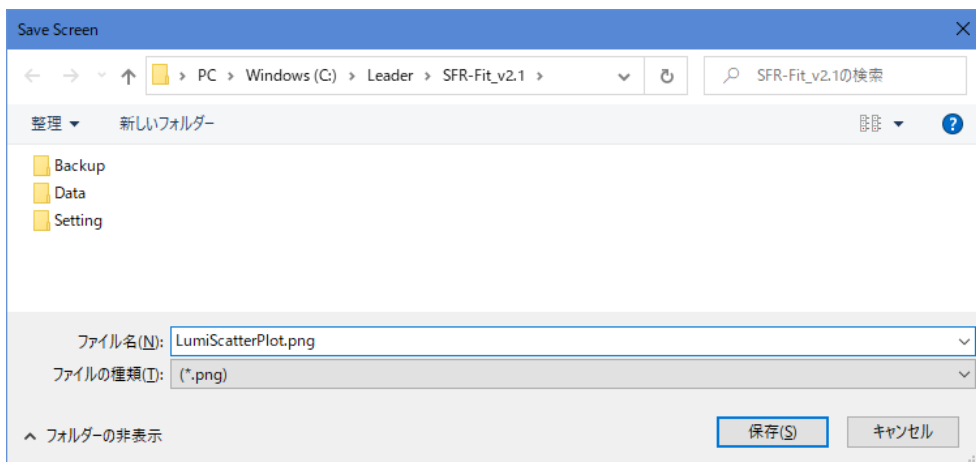

Figure 5-71 | Save Window

- **Graph Switching**

Switch tab to select a channel.

The RGB signal graph can be selected when All-channel is selected in the Output Settings Window. However, the SFR Viewer Archive image Window displays all channels.

5.10 Icons







The following icons appear on the Measurement Window and part of the Camera Window.



Figure 5-72 | Icons

The description of each icon is as follows.

Table 5-1 | Icon Description

	Restore Display	Restore the original display.
	Zoom out	Clicking on Window will reduce the size of the image.
	Zoom in	Click or drag the window to specify the area to be enlarged. Click or drag the Window to zoom in on an area.
	Movement	Move the display range by dragging the Window.
	Save As	Name and save the window in "png" format.
	Copy as image	Copy the window as image data.
	Copy as vector graphics	Copy Window as vector data.

6 Troubleshooting

SFR-Fit displays either "Error," "Warning," or "Information" messages along with an Error Code depending on the usage status. If any of these messages appear, take appropriate action.

- **Error**

This message is displayed when an abnormality occurs and measurement cannot be continued.

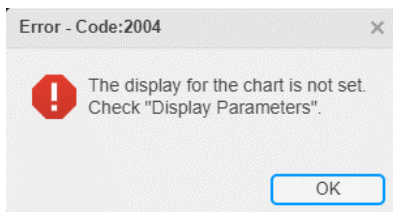

Figure 6-1 | Error

- **Warning**

It is displayed when there is something to note.

Measurement can continue, but please change the settings as necessary.

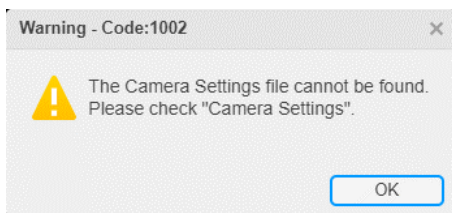

Figure 6-2 | Warning

- **Information**

It is displayed when information is notified.

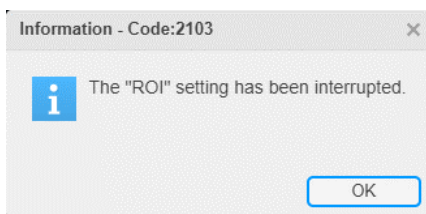

Figure 6-3 | Information

6.1 Error Code List

Code	Classification.	Message
1002	Warning	The Camera Settings file cannot be found. Please check "Camera Settings."
1003	Error	The camera is not connected. Please check "Camera Settings."
2001	Error	Only one Display was found to be connected to this PC. Please connect two or more displays to the PC to perform the measurement.
2002	Error	Outside valid frequency range. Change the maximum frequency or the minimum frequency.
2003	Error	The intervals between the frequencies to be measured are too narrow. Reduce the number of measurement points or increase the measurement range.
2004	Error	The display for the chart is not set. Check "Display Parameters".
2005	Error	Not enough Display connected to PC. Change the settings or connect the Display.
2006	Error	There is a problem with the Display settings. Check "Display Parameters".
2101	Warning	The ROI size should be set to a value of 30 pixels or more.
2102	Warning	ROIs overlap.
2103	Information	The "ROI" setting has been interrupted.
2104	Warning	Only numerical values can be entered for X-pos.
2105	Warning	Only numerical values can be entered for Y-pos.
2106	Warning	Only numerical values can be entered for Size.
2107	Warning	The input range for Size is 30 to **.
2108	Warning	The input range for X-pos is 1 to **.
2109	Warning	The input range for Y-pos is 1 to **.
2110	Error	Failed to connect the camera.
2111	Warning	Up to 9 ROIs can be set on a single display.
2112	Warning	At least one ROI is required.
2113	Warning	Only numerical values can be entered for Angle.
2114	Warning	The input range for Angle is -180 to 180.
2115	Warning	"freq= **[C/P]" is an invalid measurement point. Change the bar angle or frequency interval.
2201	Error	Failed to detect the checkerboard feature points. Please change the layout of the display.
2202	Warning	The display chart may be too close. Required relative resolution = ** times Measured value (minimum) = ** times
2203	Error	A different image size was loaded.
2302	Error	The position of the ROI is outside the measurable range. Layout the ROI so that all the ROI squares are in the bright pattern of the display chart. ROI : **-**

Code	Classification.	Message
2601	Error	There is a problem with the tone response (Overexposure). Adjust the exposure or lighting of the camera. ROI : **_**
2602	Error	There is a problem with the tone response (black floating). Adjust the exposure or lighting of the camera. ROI : **_**
2603	Error	There is a problem with the tone response (brightness switching). Adjust the camera exposure or lighting. ROI : **_**
2701	Error	Image acquisition failed.
2702	Error	Failed to calculate the measured value from the acquired image.
5001	Warning	The Camera Settings File cannot be found. Select "Camera Settings" to set the camera.
5002	Error	The camera could not be connected. Select "Camera Settings" to set the camera.
5101	Error	Unable to connect to camera device.
5201	Error	Preview failed. Please select or check camera device.
5202	Warning	The preview window is already displayed.
5301	Information	Reset the camera device.
5401	Warning	Only numerical values can be entered for X-Line.
5402	Warning	Only numerical values can be entered for Y-Line.
5403	Warning	Only numerical values can be entered for Width.
5404	Warning	The input range for X-Line is 1 to **.
5405	Warning	The input range for Y-Line is 1 to **.
5406	Warning	The input range for Width is 30 to **.
6101	Warning	Set "Maximum Frequency" to a value larger than "Minimum Frequency".
6102	Warning	Set "Minimum Frequency" to a value less than "Maximum Frequency".
6103	Error	"freq= **[C/P]" is an invalid measurement point. Change the bar angle or frequency interval.
6104	Error	"Chart Contrast" has exceeded the lower limit (2.0). Please set again.
6105	Warning	"Chart Contrast" has changed. ** → **
7001	Error	The JSON file cannot be found.
7002	Error	The JSON file cannot be read.
7003	Error	Failed to read json file.
7004	Error	Failed to calculate the measured value.
8001	Error	The JSON file cannot be found.
8002	Error	The JSON file cannot be read.
8003	Error	Image acquisition failed.
8004	Error	Failed to calculate the measured value from the acquired image.
8005	Error	Image file not found. Check the Single Image files.

Code	Classification.	Message
8006	Error	Image file not found. Check the Step Image files
8007	Error	Image file not found. Check the Bar Image files.

6.2 Error Causes and how to fix the errors

This section describes the causes and countermeasures when measurement errors or abnormalities occur.

6.2.1 Error Code 2201 (Feature point detection error)

- **Content of the error**

SFR-Fit uses a checkerboard chart to detect points called feature points.

When these feature points cannot be detected, Error Code2201 is displayed.

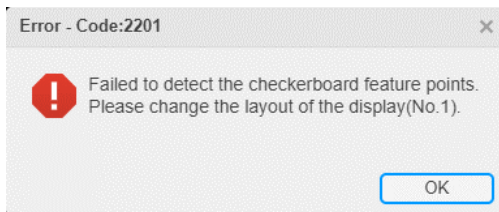

Figure 6-4 | Error Code2201

- **Cause 1**

Feature points could not be detected because part of the chart display was missing.

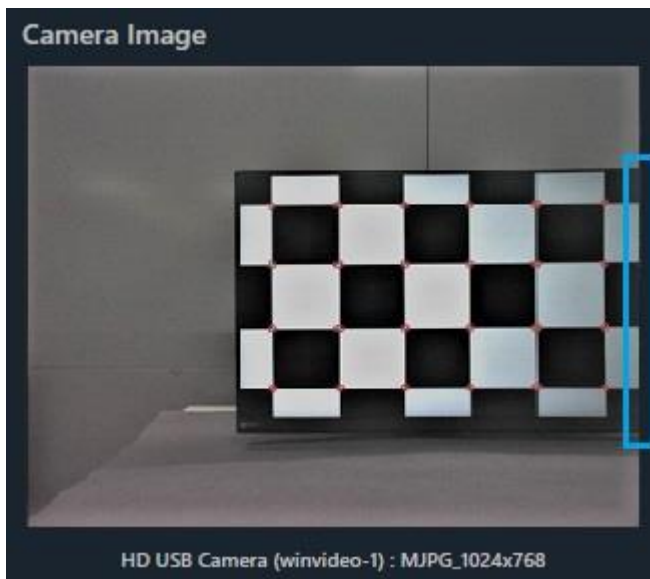

Figure 6-5 | Chart Display

- **How to fix the error**

Adjust the placement so that the entire chart display can be captured.

- **Cause 2**

Feature points are mis-detected because the background of the chart display has a pattern similar to a checker chart.

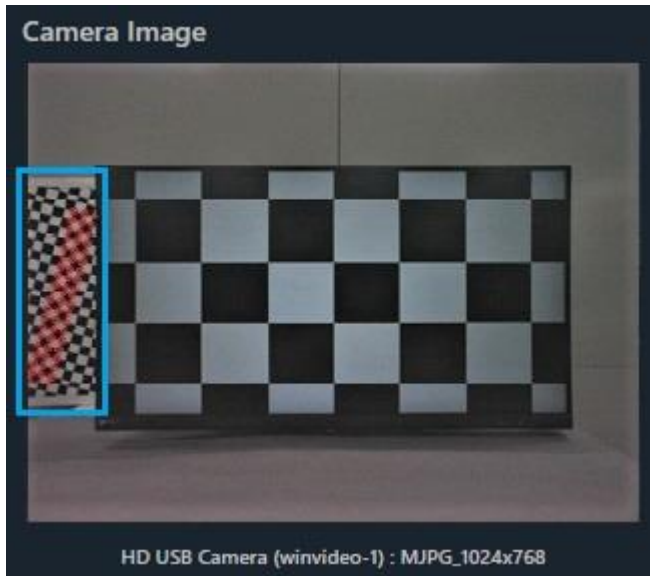

Figure 6-6 | Chart Display

- **How to fix the error**

Change the background to one that will not cause false positives. If the background cannot be changed, increase the Min Corner Metric in the Measurement Settings Menu.

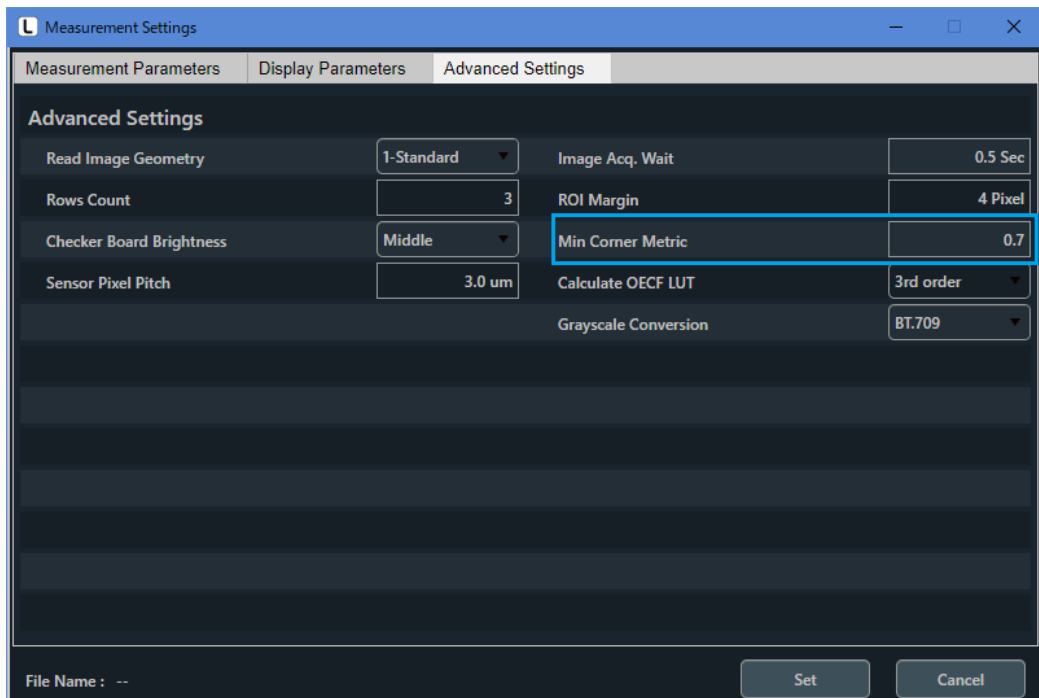

Figure 6-7 | Measurement Settings Window

- **Cause 3**

Failed to detect feature points near corners, due to low contrast uniformity of the checker chart.

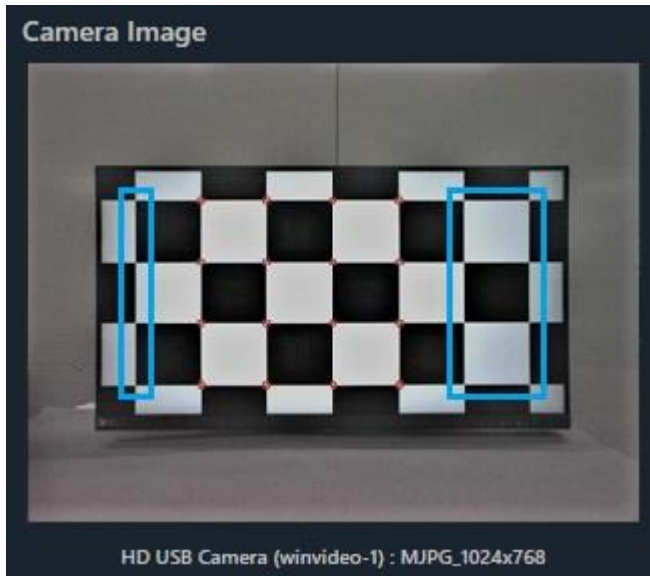

Figure 6-8 | Chart Display

- **How to fix the error**

Set Checkerboard Brightness to Light in the Measurement Settings Menu.
If it is still not detected, decrease the Min Corner Metric.

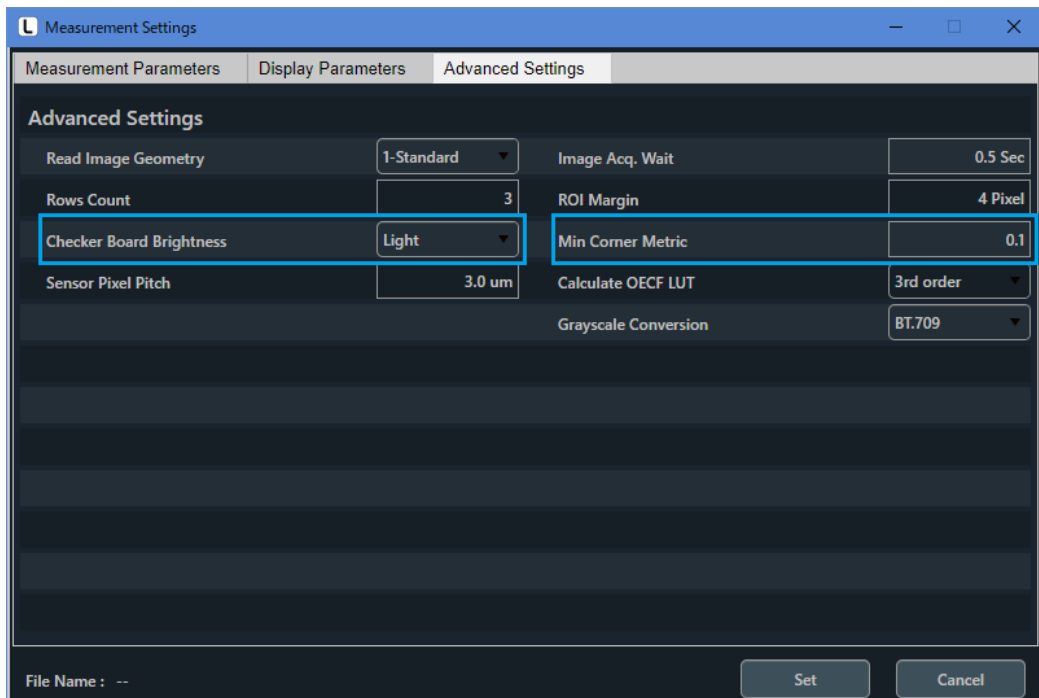

Figure 6-9 | Measurement Settings Window

6.2.2 Error Code 2601 (Tone response error)

- **Content of the error**

When the camera's Auto Exposure (AE: Auto Exposure) function is enabled, Error Code 2601 may appear depending on the brightness of the background of the chart display, even if the illumination is properly set.

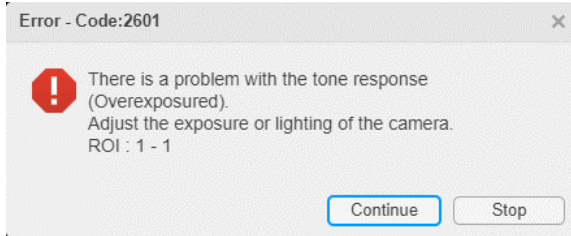

Figure 6-10 | Error Code2601

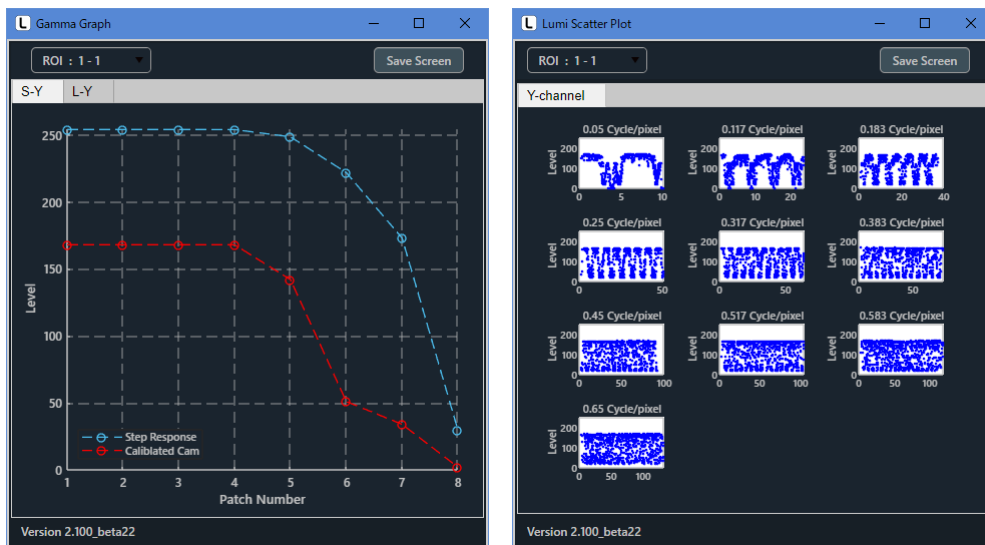

Figure 6-11 | Pop-up graph

- **How to fix the error**

To control the camera's AE function, adjust the test room lighting or adjust the illumination settings on the display chart.



Figure 6-12 | Chart Display

6.2.3 If the ROI is Shifted

- **Content of the error**

The ROI has shifted from the correct position and the measurement does not work correctly.



Figure 6-13 | Chart Display

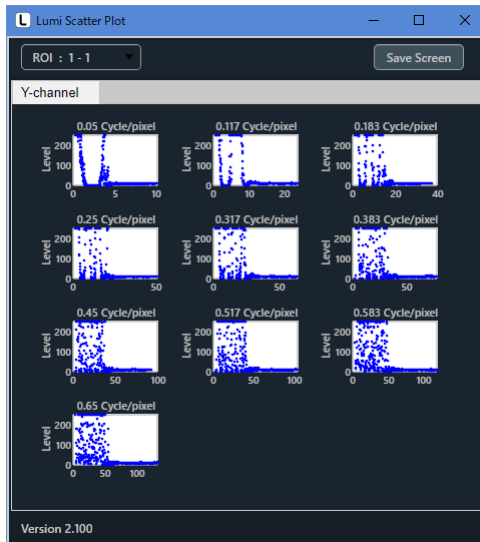

Figure 6-14 | Pop-up graph

- **Cause 1**

The measurement was incorrect because the positional relationship between the chart display and the camera changed during the measurement.

- **How to fix the error**

Do not change the position of the chart display and the camera once you have started the measurement.

- **Cause 2**

The camera image orientation is mirrored or flipped upside down.

- **How to fix the error**

Set Read Image Geometry to 2-Mirror in the Measurement Settings Menu.

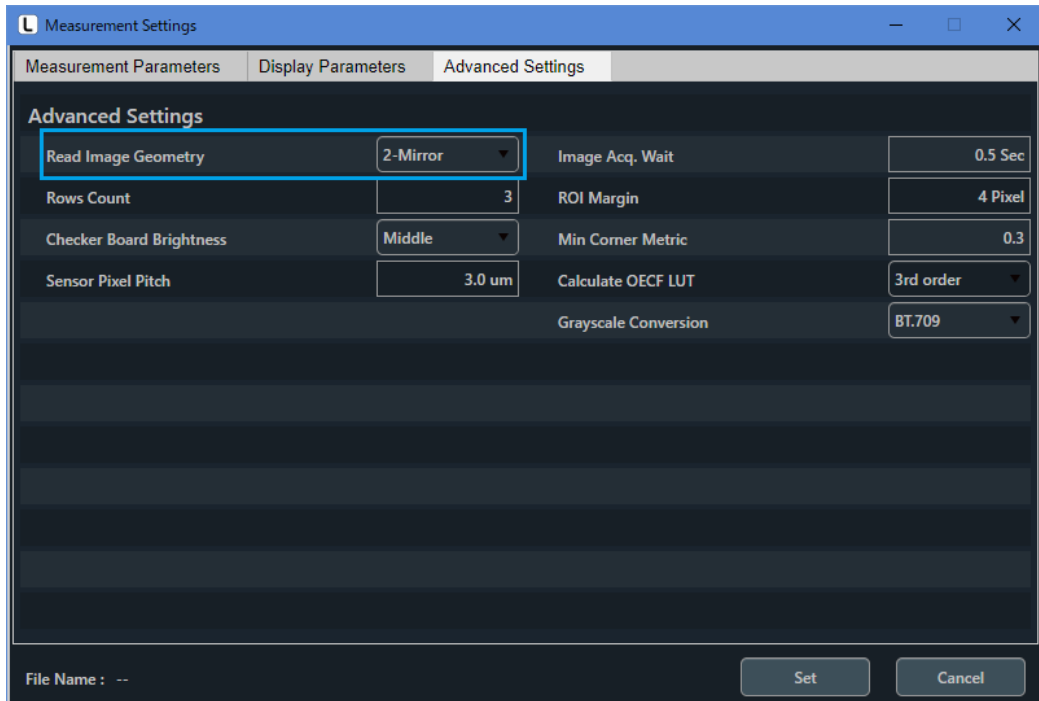

Figure 6-15 | Measurement Settings Window

6.2.4 When the Color of the Camera Image is Abnormal

- **Content of the error**

The color of the camera image becomes abnormal.

- **Cause**

The correct color could not be displayed because the camera's color space is YCbCr.

- **How to fix the error**

Set the return color space to rgb in the camera settings menu.

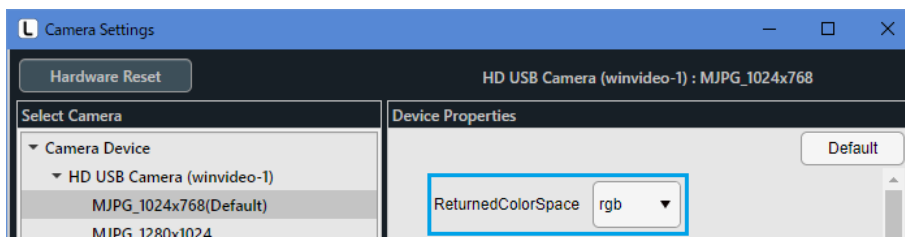

Figure 6-16 | Camera Settings Window

Leader Electronics Corporation

2-6-33 Tsunashima-higashi, Kohoku-ku, Yokohama-shi,
Kanagawa, 223-8505, Japan
www.leader.co.jp/en

Dec. 27, 2022 Ver. 1 (Software Ver. 2.1)