

Leader DIGEST CATALOG

Vol.6

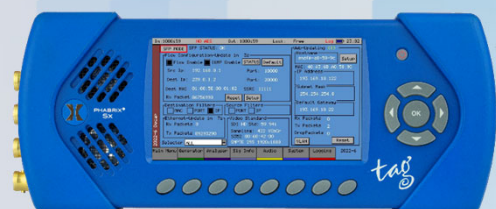
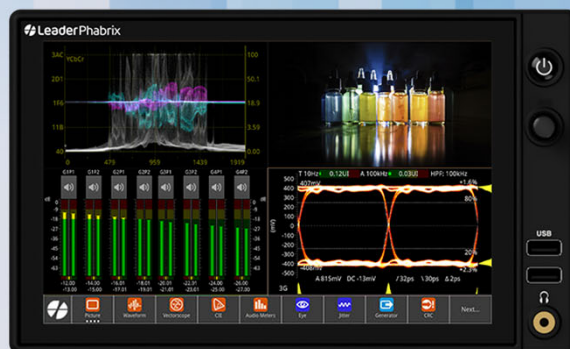

Leader

Company Profile



Engineering the future of test and measurement.

Since its founding in 1954, Leader Electronics Corporation has constantly refined measurement technology to support innovation within our industry. That commitment is even stronger today, in this time of drastic change.

Leader Electronics Corporation continues to expand its global business in the field of electronic measurement instruments and video distribution, providing revolutionary hardware and software solutions to help solve our customers' evolving challenges.

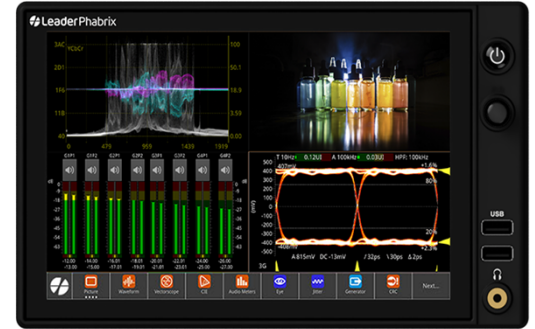

Leading measurement solutions from Leader

Leader's products are high-performance measuring instruments designed specifically for the needs of the video industry, spanning television, movies, and streaming media.

We proudly provide products incorporating the latest digital measurement and monitoring technology to a host of broadcasters, producers, distributors, editors, and equipment manufacturers worldwide.

In addition, we develop instruments for consumer electronics and electronic parts manufacturers, field maintenance equipment, and automation solutions for production testing.

In August 2019, Leader Electronics Corporation acquired PHABRIX Ltd. to grow our abilities to serve our customers.

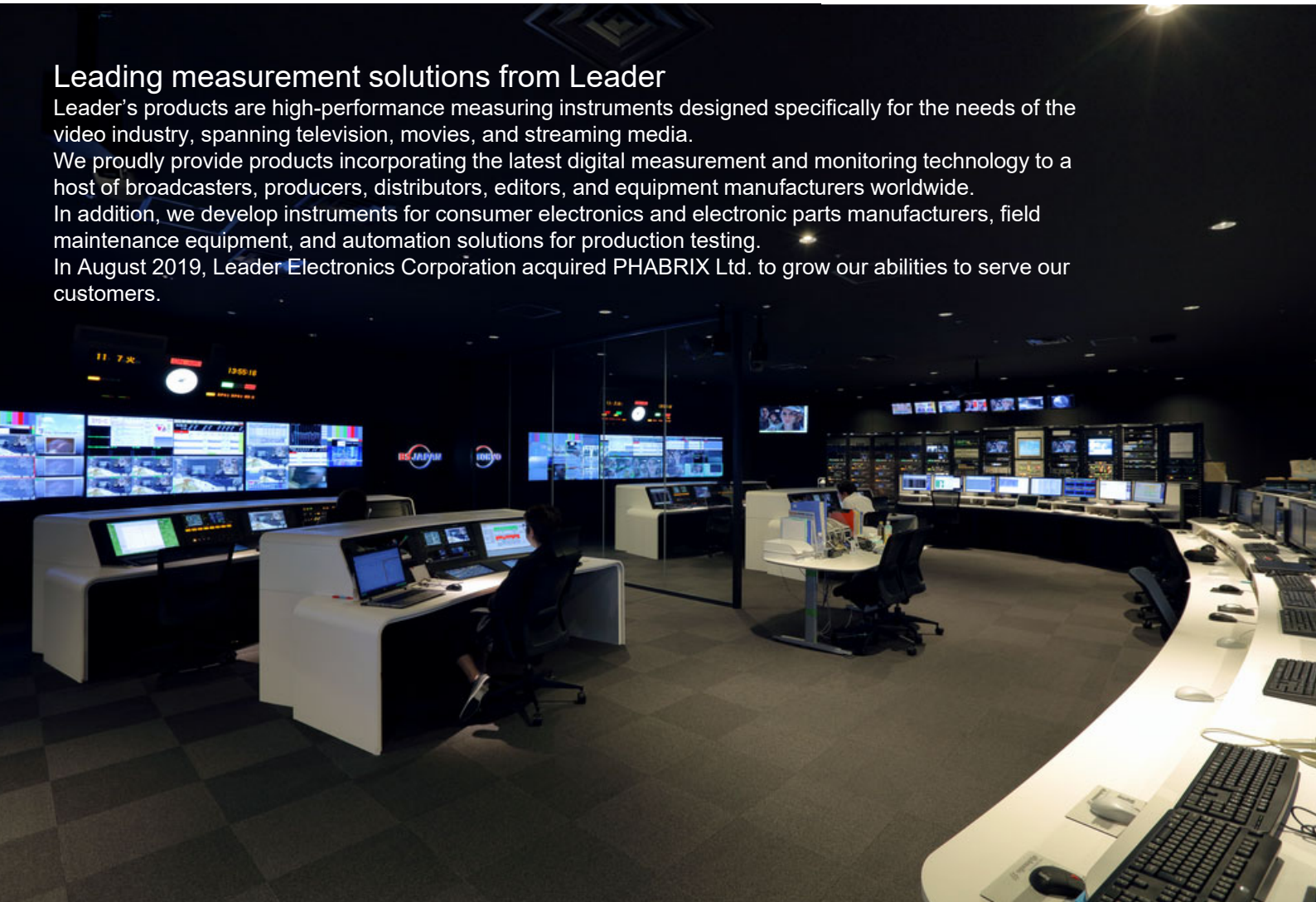

ZEN SERIES

The ZEN series LV5600W / LV5300A / LV5350 WAVEFORM MONITORS and LV7600W / LV7300 RASTERIZERS are precision measurement tools to address all your video and audio testing needs. Having updated hardware and software, 12G-SDI as well as up to 25G video over IP interfaces, newly developed function WebRTC remote capability, HDR/SDR conversion by 3D LUT and False Color display functions etc. are newly added from 2024 version. The test and measurement of video signals is straightforward with waveform, vector, picture and eye pattern displays. Comprehensive status displays, error logs and an ANC Data Viewer help you troubleshoot your system when there are problems. The Zen series also offers complete audio monitoring, for discrete digital, analog, or embedded audio. Audio monitoring views include multi channel level metering, Lissajous, status, and loudness measurement.

The JPEG XS option also has been available as wider range of IP systems.

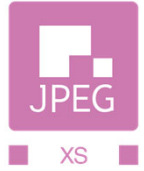

LV5600W

2K/4K/IP/4 INPUT WAVEFORM MONITOR



Display Size : 7 inches
 Dimensions (WHD mm) 215x132x298
 (3U 1/2 Rack size)



LV7600W

2K/4K/IP/4 INPUT RASTERIZER



Dimensions (WHD mm) : 426x44x300
 (1U Full Rack size)



LV5300A

2K/4K/2 INPUT WAVEFORM MONITOR



EYE Pattern
 Display Size : 7 inches
 Dimensions (WHD mm) : 215x132x120 (3U 1/2 Rack size)
 Power supply : DC10V~DC18V



LV5350

2K/4K/2 INPUT WAVEFORM MONITOR



Display Size : 7 inches
 Dimensions (WHD mm) : 215x85 x120 (3U 1/2 Rack size)
 Power supply : DC10V~DC18V



LV7300

2K/4K/2 INPUT RASTERIZER



Dimensions (WHD mm) : 215x44x300 (1U 1/2 Rack size)
 Power supply : DC10V~DC18V



LV7290

REMOTE CONTROLLER

Enables long distance operation through Ethernet
 Controls up to 8 units from one controller
 Applicable model:
 LV5900A/LV5600W/LV5300A/LV5350/LV7600W/LV7300
 Dimensions (WHD mm) : 482x44x110 (1U Full Rack size)



ZEN Series Options

■LV5600W/ LV7600W Hardware options

Description	Model		Function
	LV5600W	LV7600W	
SDI INPUT	LV5600-SER01		SD,HD,3G SDI input *1
SDI INPUT/EYE	LV5600-SER02A		SD,HD,3G SDI input and EYE pattern display *1
DIGI/ANA AUDIO	LV5600-SER03	LV7600-SER03	Digital/ Analog audio input & output display
DOLBY	LV5600/LV7600-SER07		Dolby Digital, Dolby E decode and metadata *2
10G IP INPUT	LV5600-SER05	LV7600-SER05	10G IP input *1
25G IP INPUT	LV5600-SER06	LV7600-SER06	25G IP input *1 *3

*1 A minimum of one of LV5600-SER01, LV5600-SER02A, LV5600-SER05 or LV5600-SER06 required for LV5600W

A minimum of one of LV5600-SER01, LV5600-SER02A, LV7600-SER05 or LV7600-SER06 required for LV7600W

*2 Requires LV5600-SER03 for LV5600W, LV7600-SER03 for LV7600W

*3 For 4K, only a single stream is supported. You also need the SER28

■LV5600W/ LV7600W Software options

Description	Model		Function
	LV5600W	LV7600W	
HDR	LV5600-SER23	LV7600-SER23	HDR measurement
TSG	LV5600-SER24	LV7600-SER24	SDI signal generation *1
FOCUS ASSIST	LV5600-SER25	LV7600-SER25	Focus assist display
LAYOUT	LV5600-SER26	LV7600-SER26	Customized layout /Display assignment
TALLY	LV5600-SER27	LV7600-SER27	Tally display
4K	LV5600-SER28	LV7600-SER28	4K signal support(3G-Quad,3G-Dual,HD-Quad)
12G-SDI	LV5600-SER29	LV7600-SER29	12G-SDI / 6G-SDI *2
VIDEO NOISE METER	LV5600-SER30	LV7600-SER30	Camera signal to noise measurement
COLORIMETRY ZONE	LV5600-SER31	LV7600-SER31	Colors outside the color gamut display function
25G IPTSG	LV5600-SER32	LV7600-SER32	25G IP signal generation function *3
JEPG XS	LV5600-SER33	LV7600-SER33	JEPG XS Analyzer/Decode/JEPG XS IP signal generation function *4
EXTENDED VECTOR	LV5600-SER40	LV7600-SER40	RGB Vector , YCbCr Vector

*1 To support 4K, LV5600-SER28 and LV7600-SER28 are required. To support 12G-SDI, LV5600-SER28 + LV5600-SER29 and LV7600-SER28 + LV7600-SER29 are required.

*2 LV5600-SER28 is required for LV5600W. LV7600-SER28 is required for LV7600W.

*3 LV5600-SER06 is required for LV5600W. LV7600-SER06 is required for LV7600W. To support 4K, LV5600-SER28 and LV7600-SER28 are required.

*4 LV5600-SER06 is required for LV5600W. LV7600-SER06 is required for LV7600W. To support 4K, LV5600-SER28 and LV7600-SER28 are required. To support JEPG XS TSG, LV5600-SER32 and LV7600-SER32 are required.

■LV5300A / LV5350 / LV7300 Hardware options

Description	Model			Function
	LV5300A	LV5350	LV7300	
SDI INPUT	–	Standard feature	LV7300-SER01	SD,HD,3G SDI input
SDI INPUT/EYE	Standard feature	–	–	SD,HD,3G SDI input and EYE pattern display
BATTERY ADAPTER V MOUNT	LV5300-SER11	LV5350-SER11	–	V mount type battery adapter
BATTERY ADAPTER QR GOLD	LV5300-SER12	LV5350-SER12	–	QR gold mount type battery adapter

■LV5300A / LV5350 / LV7300 Software options

Description	Model			Function
	LV5300A	LV5350	LV7300	
AUDIO	LV5300-SER20	LV5350-SER20	LV7300-SER20	AUDIO display – 8 channels of embedded plus phase
CLOSED CAPTION	LV5300-SER21	LV5350-SER21	LV7300-SER21	EIA-608, 708, TELETEXT, Japanese subtitle display
CIE	LV5300-SER22	LV5350-SER22	LV7300-SER22	CIE Chart display
HDR	LV5300-SER23	LV5350-SER23	LV7300-SER23	HDR measurement
TSG	LV5300-SER24	LV5350-SER24	LV7300-SER24	SDI signal generator
FOCUS ASSIST	LV5300-SER25	LV5350-SER25	LV7300-SER25	Focus assist display
LAYOUT	LV5300-SER26	LV5350-SER26	LV7300-SER26	Customized layout
TALLY	LV5300-SER27	LV5350-SER27	LV7300-SER27	Tally display
4K	LV5300-SER28	LV5350-SER28	LV7300-SER28	4K(12G-SDI/6G-SDI/3G-SDI Dual)
EXTENDED VECTOR	LV5300-SER40	LV5350-SER40	LV7300-SER40	RGB Vector , YCbCr Vector

LV5600-SER01 LV7300-SER01

SDI INPUT

LV5600-SER02A

SDI INPUT WITH EYE PATTERN

Options add SDI inputs to the product. The LV5600-SER02A option offer SDI inputs with EYE pattern and Jitter functions.

NOTE: The LV5300A comes standard with EYE, and EYE features are not available on the LV5350.

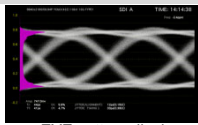

EYE pattern display with histogram

LV5600-SER03 LV7600-SER03

DIGITAL/ANALOG AUDIO

LV5600/LV7600-SER07

DOLBY E DECODING FUNCTION

Support AES/EBU Audio and Analog Audio in/out. Features include audio bars, Lissajous, surround, loudness displays and Lip Sync(AV delay) as well as audio error reporting.

Additionally LV5600/LV7600-SER07 option is installed, Dolby E, Dolby Digital, Dolby Digital Plus can be decoded and displayed.

LV5600-SER05 LV7600-SER05

10G IP INPUT (SMPTE ST 2022-6, SMPTE 2110-20)

LV5600-SER06 LV7600-SER06

25G IP INPUT (SMPTE ST 2022-6, SMPTE 2110-20)

IP interface options for LV5600W / LV7600W, supporting SMPTE ST 2022-6, SMPTE 2110-20/-30/-40, NMOS IS-04 and IS-05 for 3G/HD and 4K video.

LV5300-SER11 LV5350-SER11

BATTERY IDX

LV5300-SER12 LV5350-SER12

BATTERY ANTON BAUER

LV5300-SER11/LV5350-SER11

Battery mount adapter for V mount Battery

LV5300-SER12/LV5350-SER12

Battery mount adapter for Anton Bauer battery

LV5300-SER20 LV5350-SER20 LV7300-SER20

AUDIO DISPLAY FUNCTION

Provide Lissajous, and surround displays, Lip Sync(AV delay), in addition to monitoring channel levels and errors such as mutes or clicks.

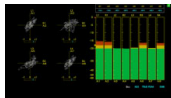

Audio display

LV5300-SER21 LV5350-SER21 LV7300-SER21

CLOSED CAPTION

Decode and display closed caption of CEA-608/CEA-708, Teletext and OP47 subtitle with rendering on the picture.

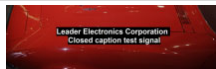

Closed caption display

LV5300-SER22 LV5350-SER22 LV7300-SER22

CIE CHART DISPLAY FUNCTION

Enable support for ITU-R BT.601, ITU-R BT.709, and ITU-R BT.2020 colorimetry.

(LV5600W and LV7600W are standard features.)

xy chromaticity Display



LV5600-SER23 LV7600-SER23

LV5300-SER23 LV5350-SER23 LV7300-SER23

HDR FUNCTION

Enable complete monitoring of the luminance levels of HDR signals, with support for HLG, PQ, and S-Log 3 as specified in ITU-R BT.2100. Luminance levels are shown in Nits, accounting for the OOTF.

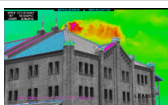

HDR zone display

LV5600-SER24 LV7600-SER24

LV5300-SER24 LV5350-SER24 LV7300-SER24

SDI SIGNAL GENERATOR FUNCTION

Options provide HD SDI test pattern generator for 2K-HD/3G and 4K-3G quad/12G SDI formats. Please note, for 12G-SDI test signals, both the 4K and 12G-SDI options are required. (LV5300A, LV5350 and LV7300 are output from SDI output terminal 2 according to the output setting.)

LV5600-SER25 LV7600-SER25

LV5300-SER25 LV5350-SER25 LV7300-SER25

FOCUS ASSIST FUNCTION

Enable focus detection, using a new algorithm optimized for high resolution images. Focus can easily be adjusted with sensitivity even in low contrast scenes.

Focus Assist (Green indicates focus)



LV5600-SER26 LV7600-SER26

LV5300-SER26 LV5350-SER26 LV7300-SER26

CUSTOMIZED LAYOUT FUNCTION

LV5600-SER26, LV7600-SER26, LV5300-SER26, LV5350-SER26, LV7300-SER26 enables both the location and size of displays such as waveform, vector, picture to be customized by the user. With display assignment, any given signal can also be rendered in up to 4 different views. (Display assignment is only for LV5600-SER26 and LV7600-SER26)



Customized layout display

LV5600-SER27 LV7600-SER27

LV5300-SER27 LV5350-SER26 LV7300-SER27

TALLY DISPLAY FUNCTION

Enable remote tally display. In the LV5600W and LV7600W, camera ID, iris and tally are available via RS-422/485 connectors.

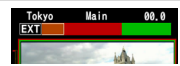

ID/Iris/Tally display

LV5600-SER28 LV7600-SER28

LV5300-SER28 LV5350-SER28 LV7300-SER28

4K FORMAT

LV5600-SER29 LV7600-SER29

12G-SDI

LV5600W/LV7600W

LV5600W/LV7600W supports 4K formats of 3G-SDI dual and quad-link, HD-SDI quad link when the LV5600-SER28 or LV7600-SER28 is installed.

LV5600-SER29/ LV7600-SER29 is required for 4K 12G SDI.

LV5300A/LV5350/LV7300

LV5300A/LV5350/LV7300 supports 4K 12G-SDI (single link) when LV5300-SER28, LV5350-SER28, or LV7300-SER28 is installed.

LV5600-SER30 LV7600-SER30

VIDEO NOISE METER

Enables measurement of the video noise included in the intensity or RGB components of SDI signals. A window for measuring noise can be set. Selectable area for measurement to allow for effects of the lens or similar.

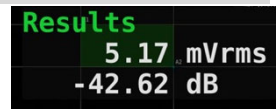

Noise meter display

LV5600-SER31 LV7600-SER31

COLORIMETRY ZONE DISPLAY

This feature simplifies the task of identifying the reproduction errors which can occur when transmitting video content produced in BT.709, DCI-P3 or BT.2020 wide color gamut or when converting content from BT.2020 to narrow color gamut.

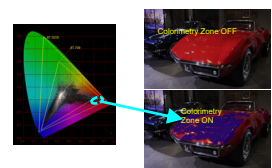

LV5600-SER32 LV7600-SER32

4K/HD IP TEST PATTERN GENERATOR

IP test pattern signal generator function that can generate HD and 4K (3840 x 2160) test patterns in compliance with the IP transmission standard (SMPTE ST 2110-20/30/31/40).

* LV5600-SER06 / LV7600-SER06 is required.

LV5600-SER33 LV7600-SER33

JPEG XS DECODE / ANALYZER / JPEG XS IP TEST PATTERN GENERATOR

IP test pattern signal generation function that can generate HD and 4K (3840 x 2160) test patterns in compliance with the IP transmission standard (SMPTE ST 2110-22).

• LV5600-SER06 is required for LV5600W. LV7600-SER06 is required for LV7600W. To support 4K, LV5600-SER28 and LV7600-SER28 are required. To support JPEG XS TSG, LV5600-SER32 and LV7600-SER32 are required.



LV5600-SER40 LV7600-SER40

LV5300-SER40 LV5350-SER40 LV7300-SER40

EXTEND VECTOR

ZEN Series Rear Panel

●LV5600W REAR PANEL

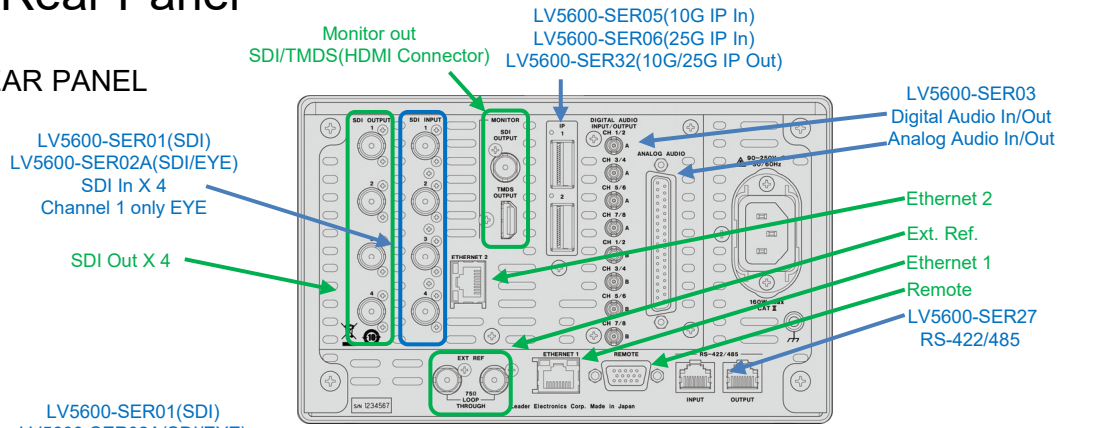

●LV7600W REAR PANEL

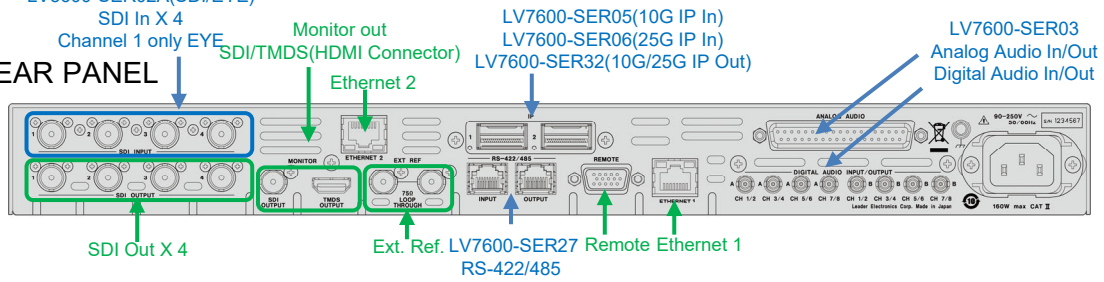

●LV5300A REAR PANEL

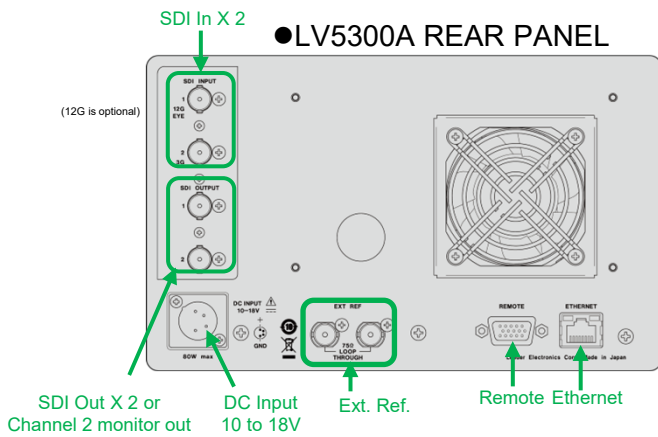

●LV5350 REAR PANEL

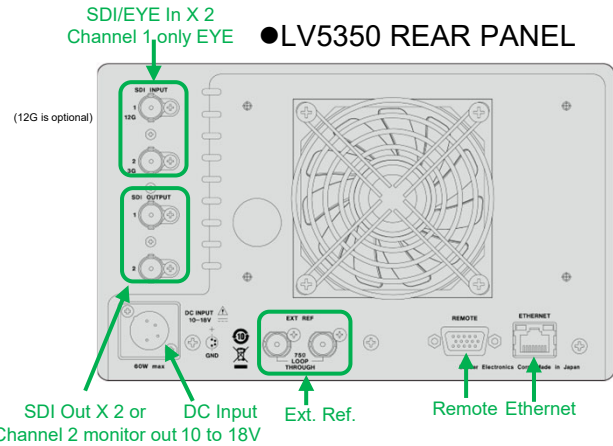

●LV7300 REAR PANEL

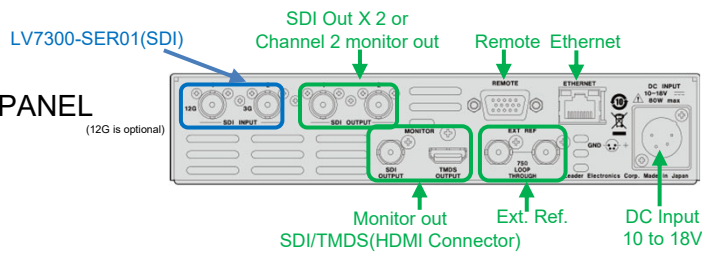

— Option
— Standard

LV5900A

8K 4K 12GSDI 3GSDI HDSDI SDSDI EYE MADI

8K Multi Waveform Monitor Compatible with 8K Video

The LV5900A waveform monitor supports SMPTE ST 2082-12, which is used to receive 7680 (8192) × 4320/59.94P YCBCR 10-bit 8K video via 12G-SDI QUAD LINK. As it supports not only 8K but also a 4K input and four simultaneous HD inputs, you can use it as a high-end 8K system and switch between other systems as needed. The waveform, vector, picture, and eye pattern displays allow for the measurement and quality control of various video signals. The status display allows you to view various error statuses and check on system stability by viewing event logs and long-term charts.



Dimensions (WHD mm): 223 x 172 x 360 (4U size)

Technical Information

■ CIE Chart (Applicable models: Zen series, LV5900A)

The CIE chart is a chromaticity diagram display which represents ITU-R BT.601, ITU-R BT.709, ITU-R BT.2020 color spaces. Both CIE 1931(xy) and CIE 1976(u'v') modes are supported. Multiple color spaces can be shown on the chromaticity chart, allowing content to be verified as BT.2020 or BT.709 color space. Colors are represented either as the full chromaticity coordinate space, or superimposed on the frame data shown on the color chart. Individual points may be directly measured with CineLite Advance. The chromaticity value is automatically indicated where the cursor is positioned on the chart display.

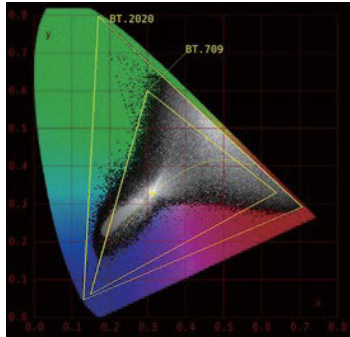

xy coordinate chart

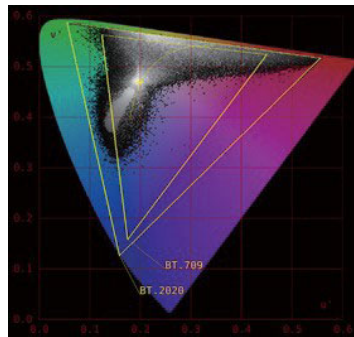

u'v' coordinate chart

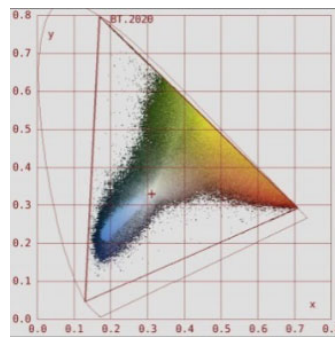

xy coordinate color chart

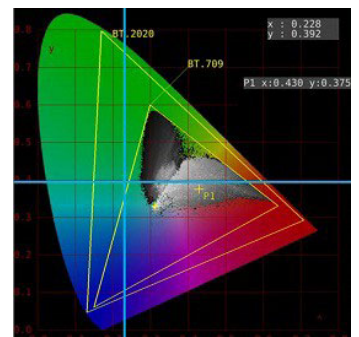

Cursor points shown in blue

■ HDR (Applicable models: Zen series, LV5900A)

HDR Zone display

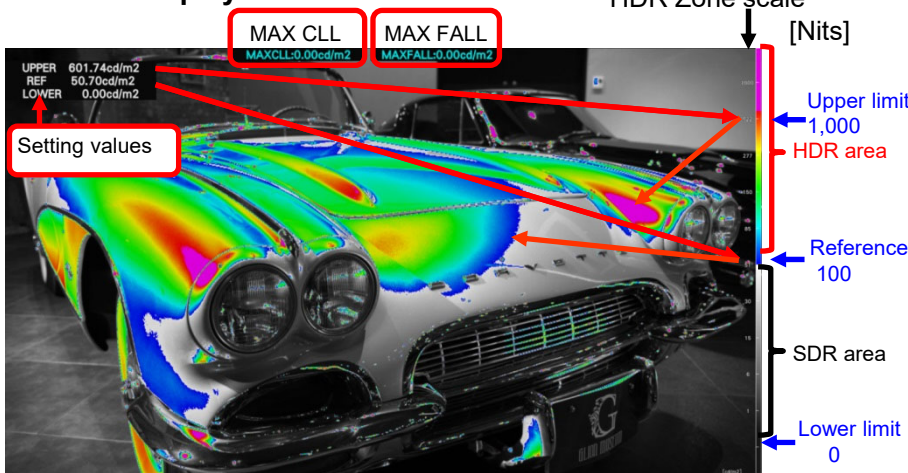

- SDR content is shown in monochrome, HDR in color, depending on brightness
- Content over the upper limit is colored magenta
- Setting values can be user defined for easy grading to a particular luminance

HDR Zone scale

[Nits]

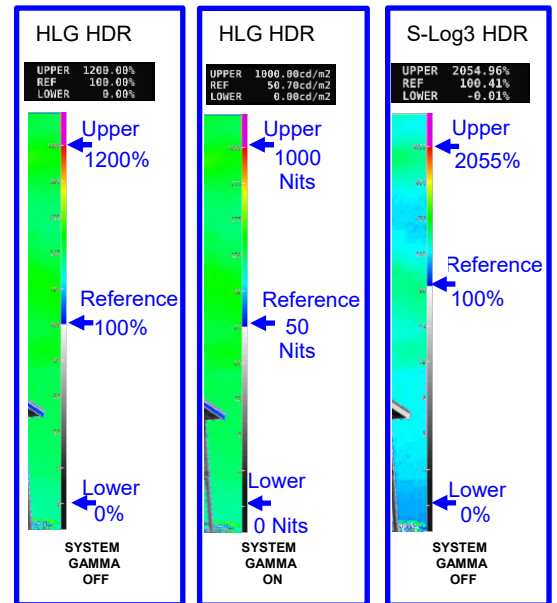

HDR waveform display

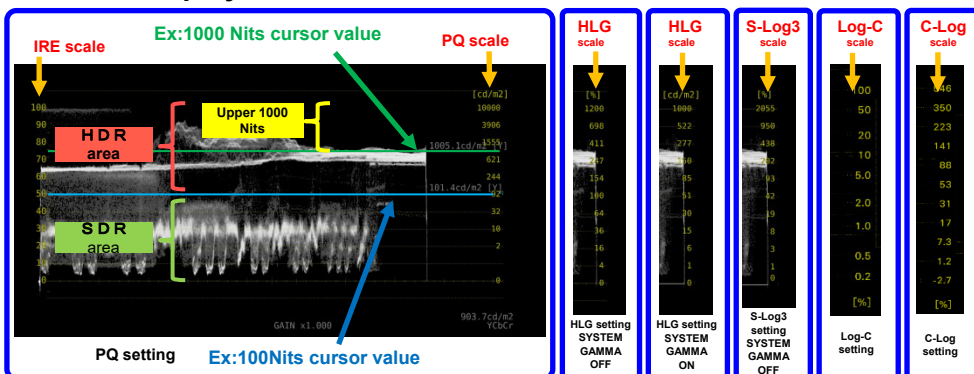

HDR point measurement

PQ setting	P1(S: 884,L: 261)3243.6cd/m2 <small>(sample, line number, candela)</small>
HLG setting SYSTEM GAMMA OFF	P1(S: 884,L: 261) 623.9%
HLG setting SYSTEM GAMMA ON	P1(S: 884,L: 261) 456.1cd/m2
S-Log3 setting SYSTEM GAMMA OFF	P1(S: 884,L: 261) 809.1%

- Cursor can be easily positioned using a USB mouse
- Up to 3 points can be measured at the same time



■ **BT.2020 Color Space Verification of HDR Color Bars** (Applicable models: LV5900A, all Zen series models)

BT.2020 color space vectorscope. BT.2020 and BT.709 values are different on vectorscope displays. If BT.2020 color bars are used, the result is centered in the targets, when using the vectorscope display and the BT.2020 setting.

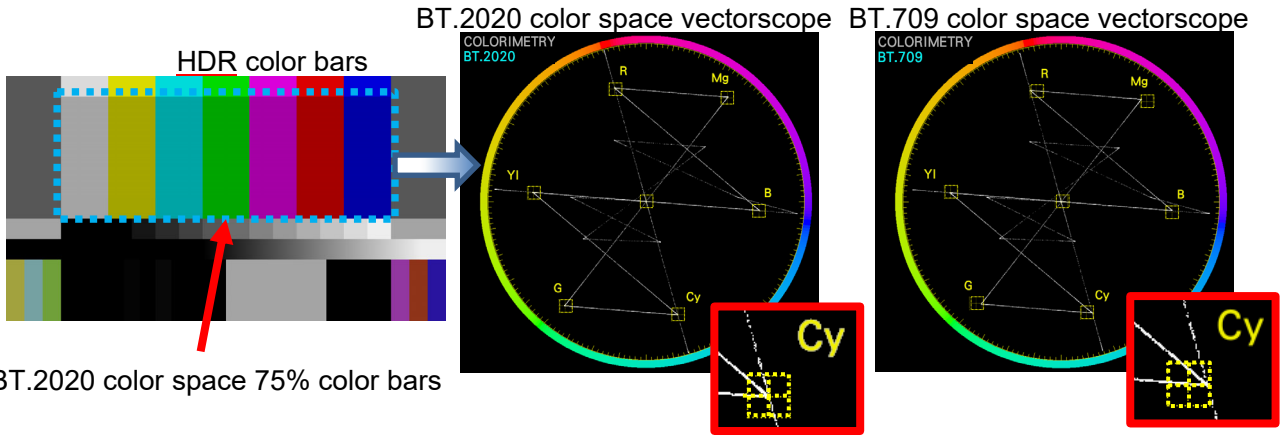

■ **UHDTV / HDR color bar compatible Vectorscope** (Applicable models: LV5900A, all Zen series models)

You can see both 75% of BT.2020 and 75% of ITU-R BT.709 color bar signals mapped to BT.2020 color gamut. (The conversion from 709 to 2020 is ITU-R BT.2087)

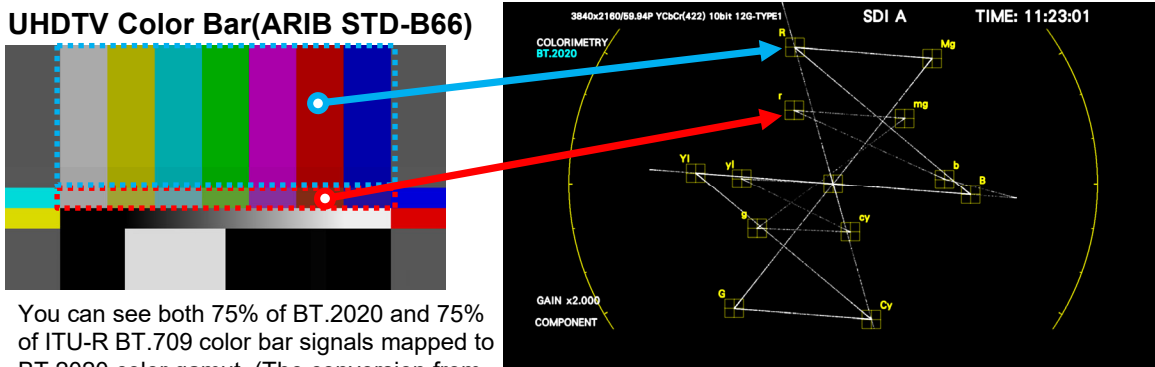

You can see both 75% of BT.2020 and 75% of ITU-R BT.709 color bar signals mapped to BT.2020 color gamut. (The conversion from 709 to 2020 is ITU-R BT.2087)

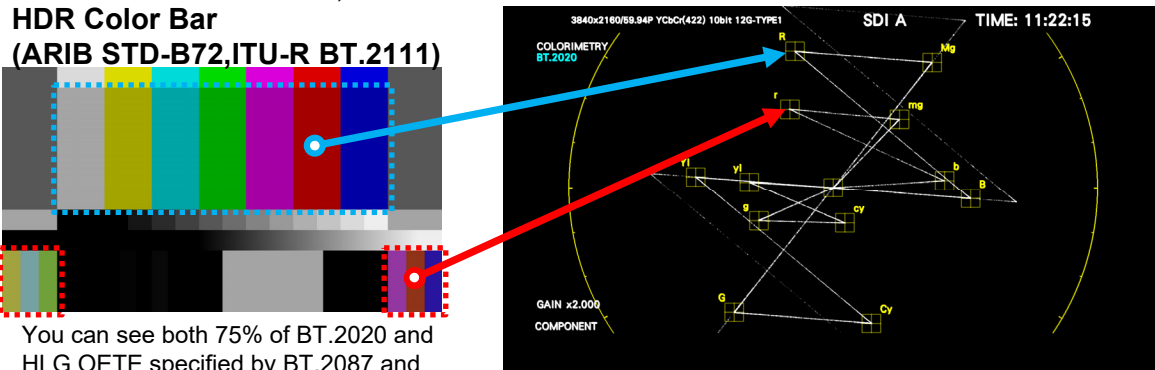

You can see both 75% of BT.2020 and HLG OETE specified by BT.2087 and BT.709 color bar using linear matrix.

■ **Colorimetry Zone Display** (Applicable models: LV5600W, LV7600W)

When converting from a wide color gamut to a narrow color gamut, such as when creating content for simulcast, it is easier to check if the color has been replaced with a color different from the image.

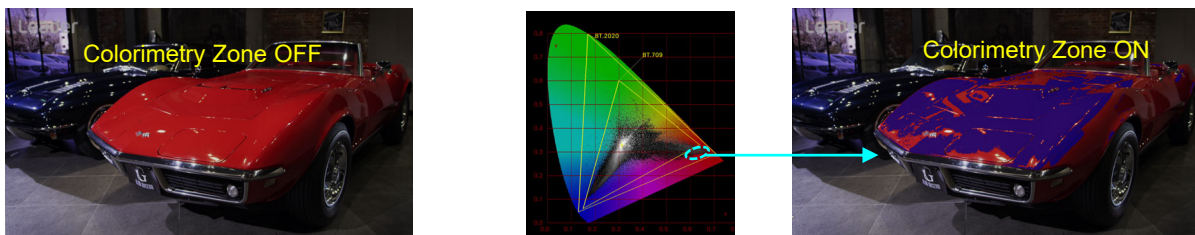

■ **External Sync Signal Input and Waveform Display** (Applicable models: LV5600W, LV7600W and LV5900A)

The phase difference and synchronization states of SDI or IP video signals can be shown graphically based on an external reference sync signal (black burst, tri-level sync).

Further more, the waveform of the applied external reference sync signal can be displayed, allowing for the early discovery of problems related to the sync signal.

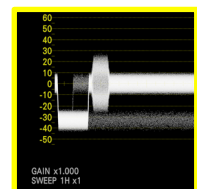
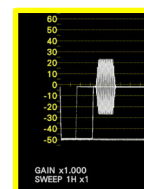
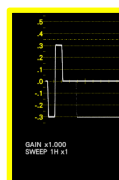

■ Loudness Display (Applicable models: LV5600W, LV7600W and LV5900A)

- Variety of triggers including panel, remote, time code, and mute
- Chart function to display loudness over time
- Both absolute and relative values are reported
- Loudness measurement of ARIB / EBU / ATSC / ITU-R BS.1770
- Logging of integrated loudness values

Selectable measurement time
2min/10min/30min/1h/2h

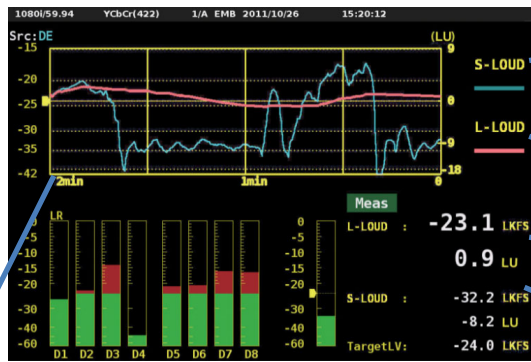

Loudness display

■ Custom Layout (Applicable models: Zen series, LV5900A)

Using the touch screen or mouse input, multiple measurement displays can be sized and located on the screen to meet the specific needs of the user.

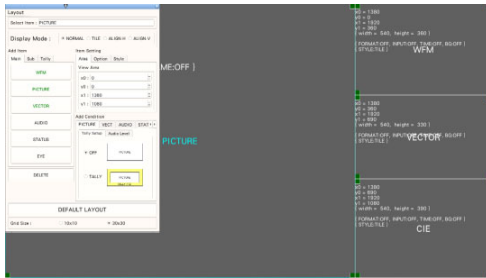

Ex: Waveform, Vector and CIE display added



■ Customized Layout (Applicable models: LV5600W, LV7600W and LV5900A)

Up to 4 channels can be displayed at the same time in the simultaneous mode, allowing for the monitoring of multiple feeds.



Ex: 4 channels display and Waveform, Vector Of main channel.



Enhanced layout configuration

Resulting layout display of 4 SDI feeds

■ Display Assignment Function (Applicable modes: LV5900A, LV5600W, LV7600W)

This function allows a single input signal to be assigned to multiple display channels regardless of whether it is an SDI or IP signal (Cannot be set when the SDI System is other than SD/HD/3G-A/3G-B-DL.)

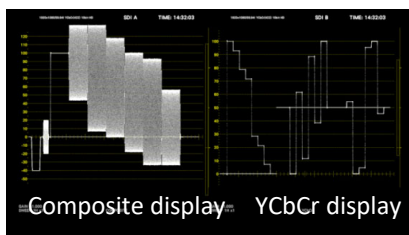

Example of simultaneous dual screen display of the same input signal in composite and YCbCr



Example of simultaneous display of the same input signal on two screens, HDR ZONE (HLG) and real

■ Closed captioning multilingual pairs (ZEN series)

•CC608

English/Spanish/Portuguese/French/German/Danish/Italian/Finnish/Swedish

•CC708

English/Spanish/Portuguese/Danish/Dutch/Faroese/Finnish/
French/German/Icelandic/Irish/Italian/Norwegian/Swedish/Korean

•OP47

English/Spanish/Portuguese/Czech/Slovak/Estonian/French/German/Italian/
Lettish/Lithuanian/Polish/Rumanian/Serbian/Croatian/Slovenian/Swedish/
Finnish/Hungarian/Turkish/Ukrainian/Rumanian/Bulgarian

*LV5300A requires LV5300-SER21, LV5350 requires LV5350-SER21, and LV7300 requires LV7300-SER21.

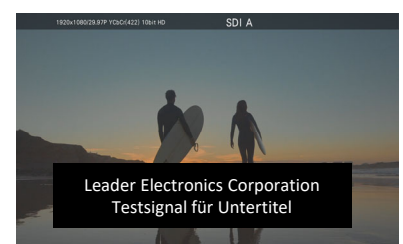

German Closed caption display

■ Event log display function (Applicable models: LV5900A, all Zen series models)

- All errors that occur can be viewed on the screen.

All errors that have occurred can be checked on the screen.
 Errors are color-coded "Not detected (white)/Detected (red)/Recovered (green)" for easy confirmation of errors on the screen.

■ SR Live Metadata Display (Applicable models: all Zen series models)

This feature decodes and displays "SR Live Metadata" packets, advocated by Sony Imaging Products & Solutions Inc.

No.	ITEM	VALUE	CTRL[Abs]	No.	ITEM	VALUE	CTRL[Abs]
1	Table Version	V 1.00	++	14	Knee	OFF	OFF
2	OETF	HLG	++	15	Knee Point	98%	[-15]
3	Transfer Matrix	BT.2020	++	16	Knee Slope	0.19	[+37]
4	Color Gamut	WIDE-BC	++	17	Knee Saturation	OFF	OFF
5	Conversion Mode	SR AIR ON	++	18	Knee Saturation Level	0.50	[+0]
6	HDR Look	Live	---	19	Soft Knee	---	---
7	HDR Black Compression	ON	---	20	Knee Radius	---	---
8	SDR Gain	-5.2dB	[-5.2dB]	21	SDR White Clip	ON	ON
9	Master Black	1.03%	[+4.7]	22	SDR White Clip Level	109%	[-94]
10	HDR Black Offset	Δ-0.99%	[-4.5]	23	HDR Knee	OFF	OFF
11	Gamma Table	STD 5	STD 5	24	HDR Knee Point	349%	[+0]
12	Gamma Step	0.45	0.45	25	HDR Knee Slope	0.65	[+0]
13	Gamma Level	0.95	[-12]				

■ SCTE-104 analysis display (Applicable models: all Zen series models)

SCTE-104 detection screen (TEXT display)

SCTE-104 message is displayed on the picture screen.

■ Timecode continuity monitoring function, time code date display (ZEN series)

SDI and IP (ST2110-40, ST2022-6) time code continuity monitoring function and display of time code and date.

- Contents of Timecode monitoring
 - Missing timecode packets.
 - Noncontiguous skipping of timecode data is occurring.
 - Duplicate timecode time information more than twice.
 - When timecode packets are not superimposed.
- Errors are displayed on the screen and recorded in the event log.
- Timecode or date display

20/07/24
 TC:OK LTC: 20:10:28.29

Date and normal condition display

Event Log
 TC NO: Missing timecode packet
 TC:RPT: Two or more duplicates of time code time data
 TC:SKIP: Discontinuity of time code time data.
 *Discontinuous dropped frame flags are not detected.

EVENT LOG LIST	SAMPLE No.16	<< NOW LOGGING >>
14:LTC 20:09:05.01	A 1920x1080/59.94I	TC:RPT,
13:LTC 20:08:36.11	A 1920x1080/59.94I	
12:LTC 20:08:36.10	A 1920x1080/59.94I	TC:SKIP,

Event log list display

■ 3D-LUT (ZEN series)

This is bidirectional conversion tool which allows HDR content to be viewed in SDR and vice versa. Processing is based on the desired 3D color lookup table as Cube file which can be imported via plug-in USB memory. On-set DITs will be able to integrate 3D LUTs instead of relying on external LUT boxes.

- It supports picture display, waveform display, vector scope, CIE chart, and histogram.
 - 2K (HD) supports up to 4 channels and 4K (UHD) supports 1 channel.
 - A maximum of 10 Cube files can be registered.
 - In HDR/SDR simultaneous production, simplified workflow without external box can be realized.
 - Interpolation method uses 33-point tetrahedral interpolation (17 points for LV5300A, LV5350, and LV7300)
 - SDI output after 3D-LUT conversion (Incompatible for LV5300A/LV5350/LV7300)
 - Input/output conversion Gamma SDR/HDR (HLG, PQ, S-LOG3, LOG-C, C-LOG), Colorimetry BT2020/BT709/DCI compatible
 - Full Range/Narrow Range support
 - Cube file information, header information display
- *3D-LUT function requires LV5600-SER23/LV7600-SER23/LV5300-SER23/LV5350-SER23/LV7300-SER23 (HDR option).

3D-LUT



3D-LUT and conversion information

LUT04 : 01S_HLGSTD5_SDI.cube
Title : 01S_HLGSTD5.srm
SDR/BT709 → SDR/BT709, FULL

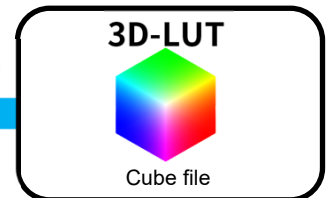
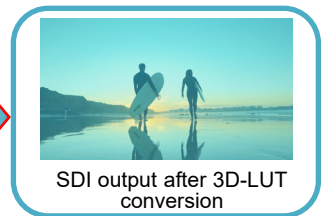

Measurement after conversion by 3D

LUT

■ SDR full range (ZEN series)

The HDR option has always been compatible with the full range, but it will be compatible with the full range of SDR without the HDR option as well.

- It supports waveform display, vector scope, CIE chart, histogram, CINELITE, and CINEZONE.
- 2K (HD) supports up to 4 channels and 4K (UHD) supports 1 channel.
- Scale change for each function
- Full range of DPX and TIFF files supported

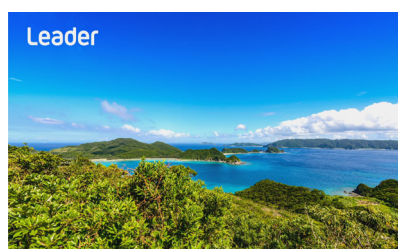

FULL Range Signal

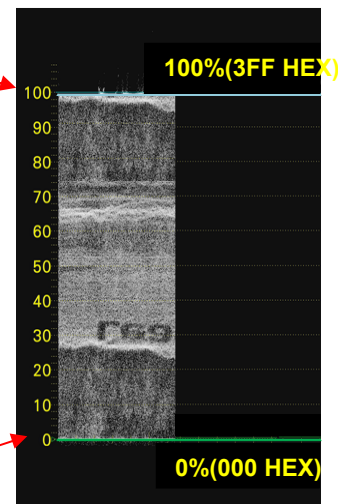
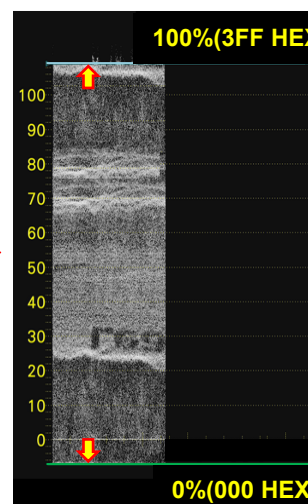

False color display (ZEN series)

False Color display has been added to the existing CineZone function. It is easy to see highlights, human skin tones, 18% Gray, blacks, etc.

- 2K (HD) supports up to 4 channels and 4K (UHD) supports 1 channel.
- False Color support for ARRI, RED and Sony cameras.
- Each value can be varied from the preset value.



False Color OFF

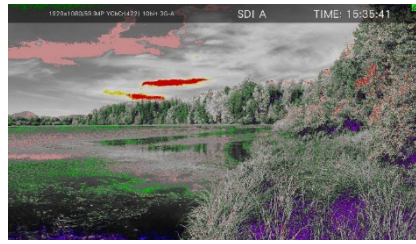

False Color USER-A

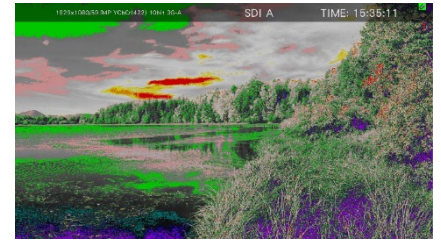

False Color USER-R

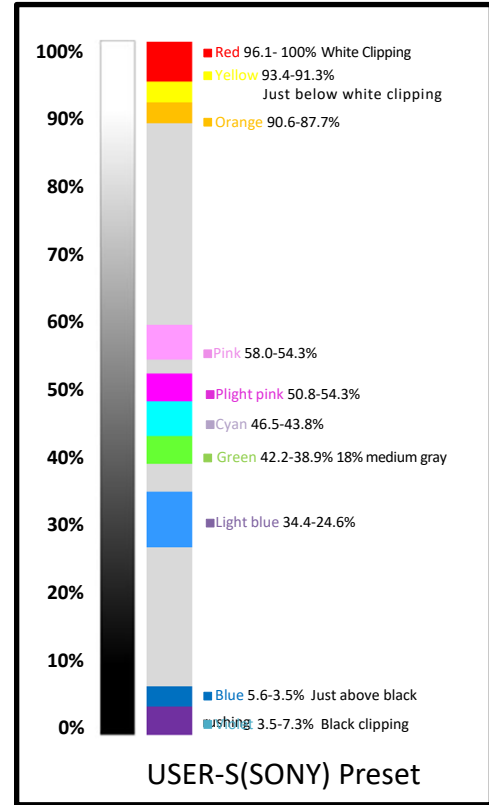
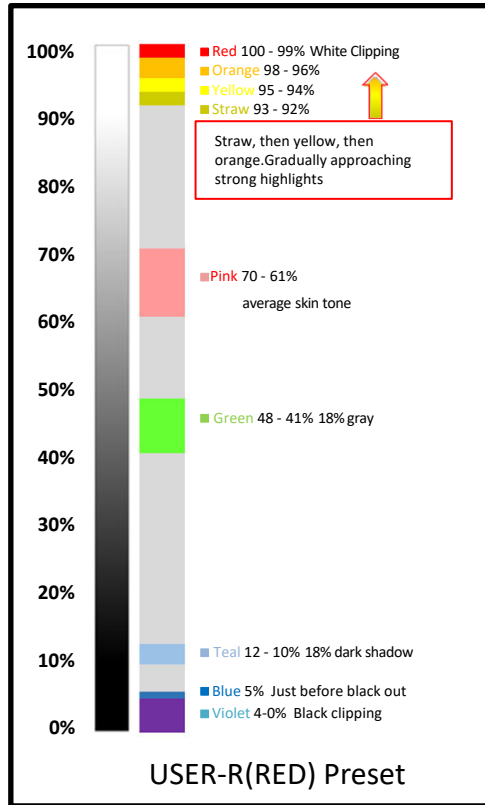
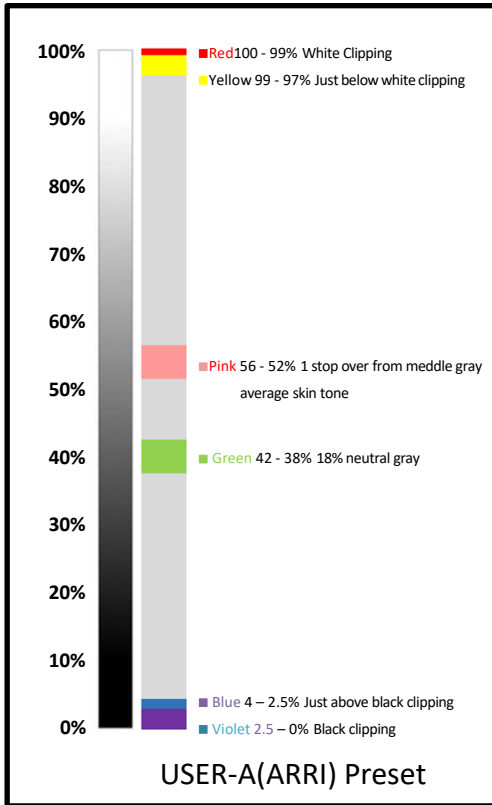

WebRTC (LV5600W, LV7600W)

Real-time display and full control of LV5600W or LV7600W via Ethernet using WebRTC technology.



IP Display (Applicable models: LV5600W, LV7600W)

Both SMPTE ST2022-6 and SMPTE 2110-20 based real-time IP transports at up to 2K image formats can be monitored. Transmission problems such as packet loss, checksum errors, as well as jitter can be monitored. Available media flows can also be identified by protocol and address. Both IP and SDI feeds can be simultaneously displayed in standard views such as waveform or picture to ensure SDI and IP operations in hybrid facilities.

IP STATUS (SER05/SER06)

Displays a list of streams contained in the IP input signal, and bit rates and errors for the IP 1 and IP 2 inputs,

Graphical display of time-series changes (IP 1:Blue, IP 2 :Green, IP 1/2 :Light green, Error :Red)

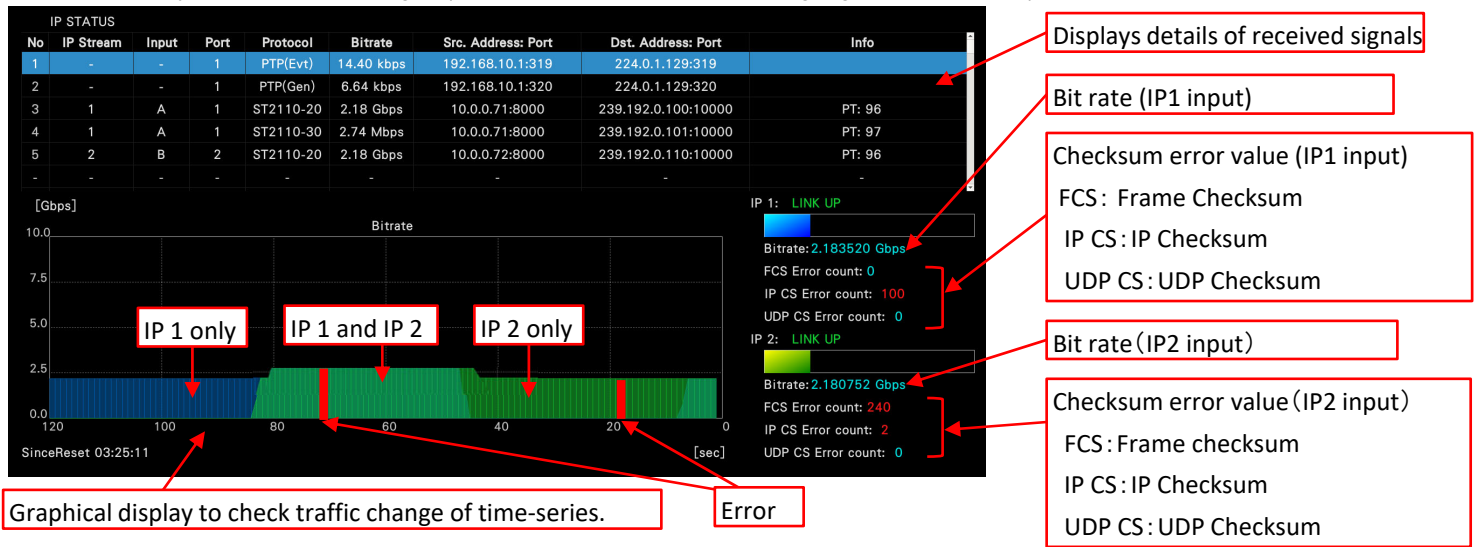

PACKET JITTER (Packet Arrival Interval Time) (SER05/SER06)

Measures IP stream packet arrival intervals and displays time fluctuations and packet loss in a graph. When ST2110 is used, the arrival interval of each of VIDEO, AUDIO, and ANC can be measured. The graph is displayed at one-second intervals, but all packets are checked for missing or reordered RTP sequence errors and displayed in red if even a single packet is in error.

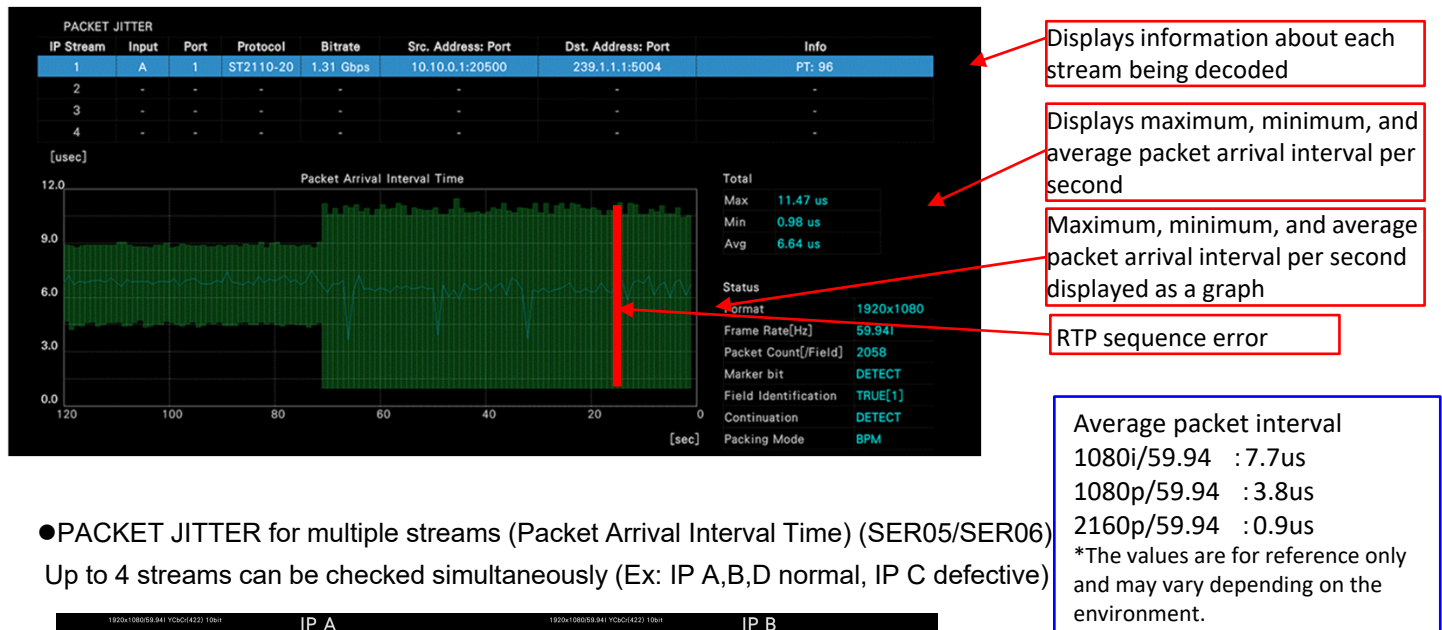

PACKET JITTER for multiple streams (Packet Arrival Interval Time) (SER05/SER06)

Up to 4 streams can be checked simultaneously (Ex: IP A,B,D normal, IP C defective)



State: Synchronous LOCK and asynchronous UNLOCK for PTP
 Time(UTC): PTP time information of LOCK Port

●PTP STATUS (Time Offset display) (SER05/SER06)

Switchable between Time Offset and Delay Time

GMID: ID of the equipment that is the time source

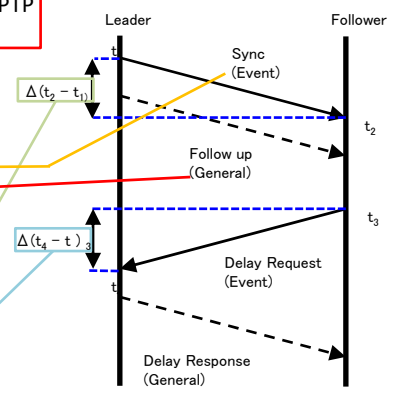
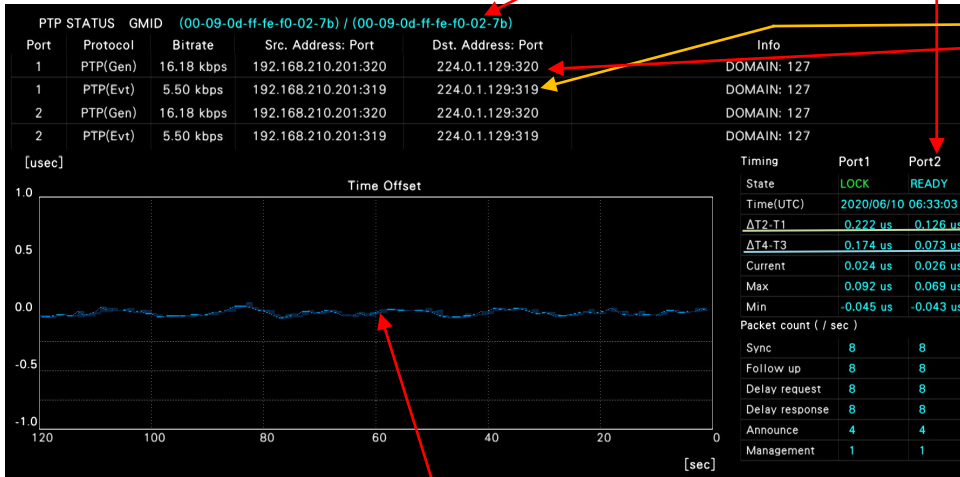

$$\text{Time Offset} = ((t - t_{21}) - (t - t_{43})) / 2$$

$$\text{Delay Time} = ((t - t_{21}) + (t - t_{43})) / 2$$

Current : Measured value per second
 Max: Maximum value during the last 1 second
 Min: Minimum value during the last 1 second

Packet count (/ sec):
 For each packet count, displays the measured value for every 1 second

Time difference per second display as a graph over time

●PTP STATUS(Delay Time graph display)



●PTP STATUS (Information display)

Name	Port1 Value	Port2 Value
DomainNumber	127	127
OriginTimestamp	0(sec) 0(nsec)	0(sec) 0(nsec)
UTC Offset	37	37
Priority1	128	128
ClockClass	248	248
ClockAccuracy	> 10s	> 10s
ClockVariance	15652	15652
Priority2	128	128
ClockIdentity	00090dfffe00feb7	00090dfffe00feb7
StepsRemoved	1	1
TimeSource	HAND_SET	HAND_SET

●PTP Timing Comparison (SER05/SER06)

By comparing the PTP time information as (1) with the Media Clock generated from the IP stream as (2), it is possible to confirm whether the video, audio, and ancillary signals are synchronized with the PTP.

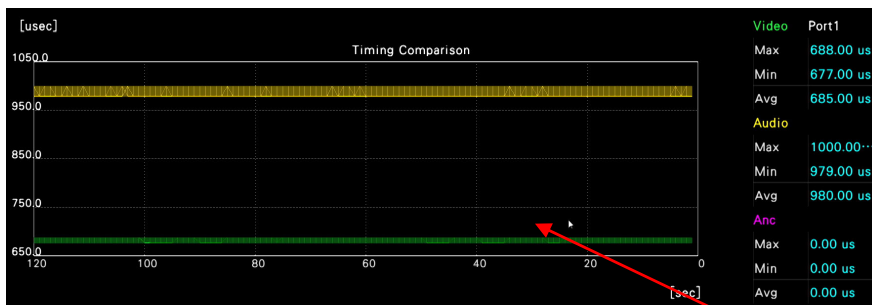

Video timing synchronized with PTP

Audio timing synchronized to PTP

Ancillary timing synchronized with PTP

PTP Timing Comparison (Failure example: asynchronous)

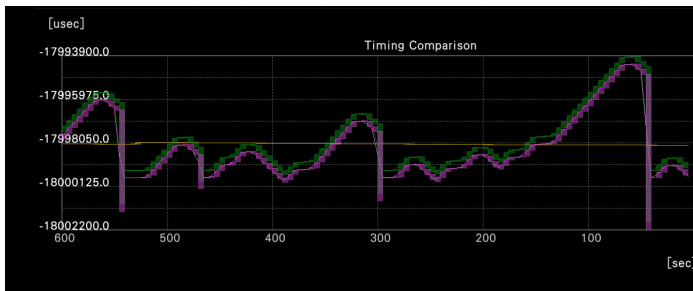

Graphical display of PTP and each phase

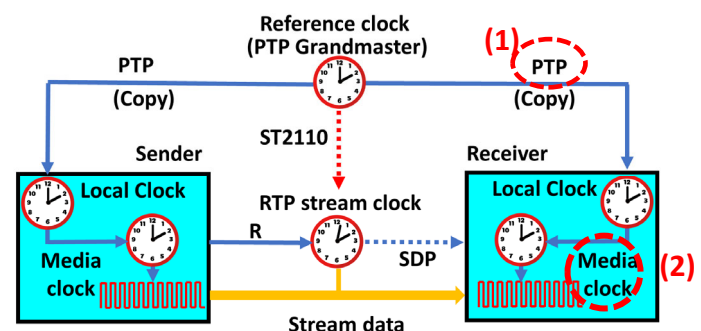

●PTP Timing Comparison (up to 4 inputs can be monitored simultaneously)

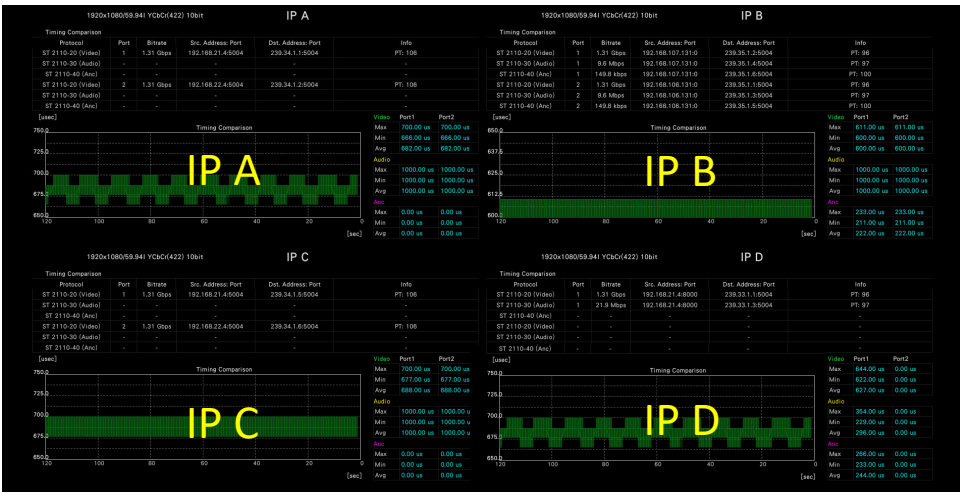

●PHASE indication (PTP vs. analog sync signal) (SER05/SER06)

Phase difference between PTP and BB can be measured

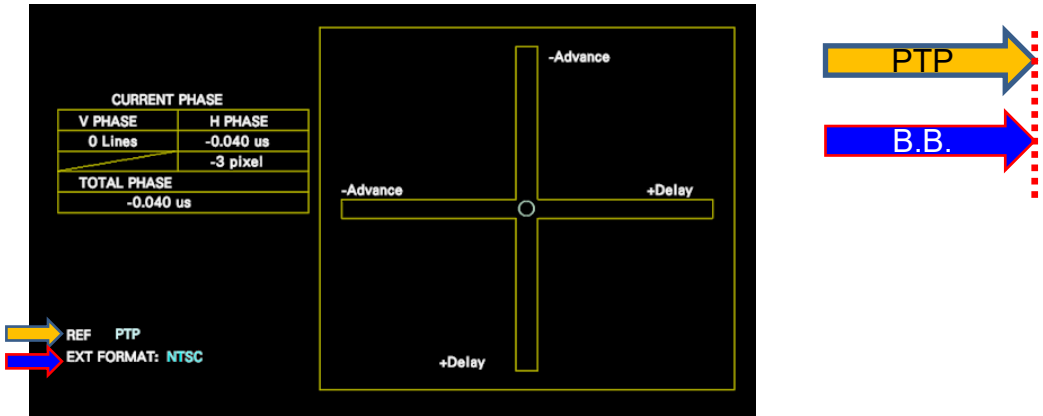

●PATH DELAY (SER05/SER06)

Measure the time difference of arriving packets between input IP ports
*The SMPTE ST2022-7 standard defined within 150µs (Class D).

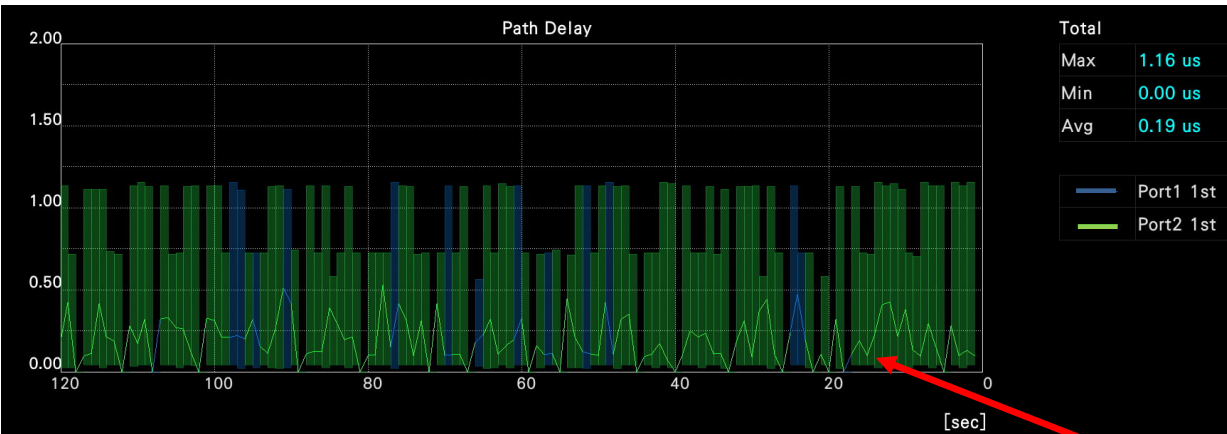

PATH DELAY (up to 4 inputs can be monitored simultaneously)

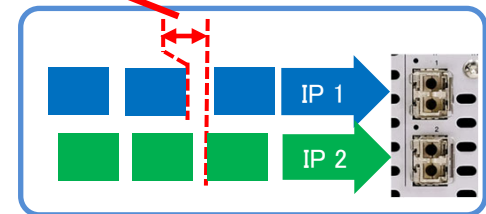

■ Displaying the buffer screen (SER06)

Displays measured values of CINST, VRX, and FPT with SMPTE ST2110-21 transmission type Narrow/Narrow Linear/Wide

● PACKET BUFFER (CINST: network compatibility model)

Cinst displays the number of packets stored from the interval at which packets are sent in the network compatibility model as specified in SMPTE ST 2110-21. The transmitter must send packets in such a way that the CMAX specified in SMPTE ST 2110-21 is not exceeded.

*The graph turns red when CMAX is exceeded.

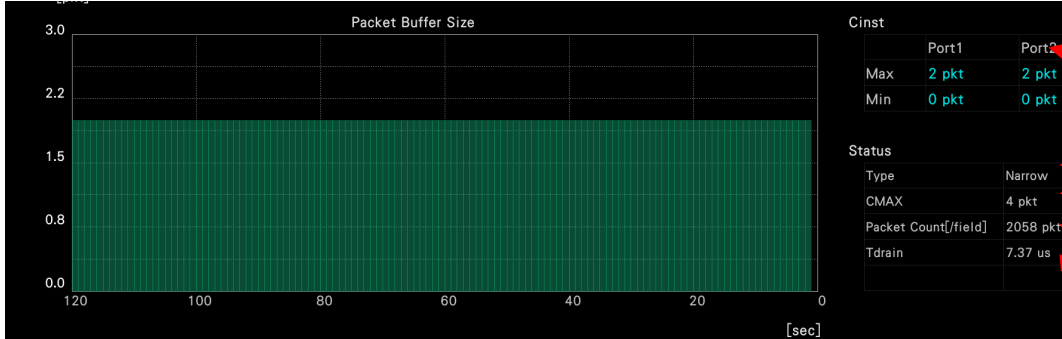
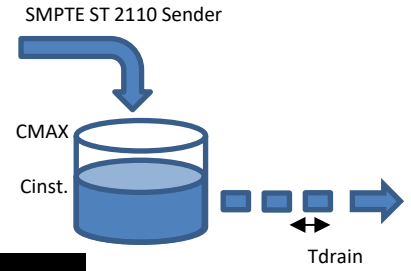

- Cinst: Instantaneous packet stored maximum and minimum value per second of the number
- Type: Displays the type set in Sender type in IP SETUP2.
- CMAX: Displays the maximum number of packets specified in SMPTE ST 2110-21
- Packet count: Displays the number of packets per field or per frame.
- Tdrain: Displays the time interval at which packets are output in network compatible models

● PACKET BUFFER (VRX: virtual receive buffer)

VRX indicates the receive buffer for packets in the virtual receive buffer model as specified in SMPTE ST 2110-21. The virtual receive buffer should not exceed VRX full as specified in SMPTE ST 2110-21.

*If VRX full is exceeded, the graph turns red.

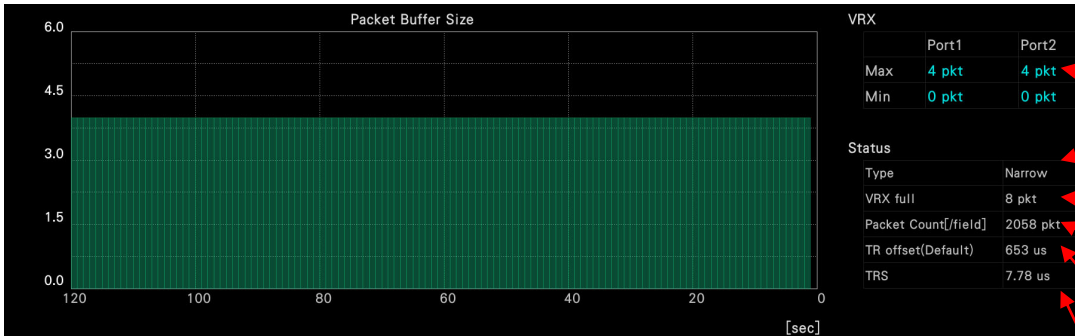
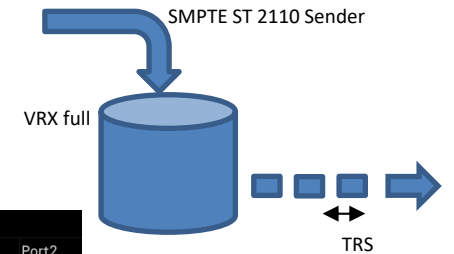

- VRX: Maximum and minimum per second of number of packets in virtual receive buffer
- Type: Displays the type set in Sender type in IP SETUP2.
- Packet count: Displays the number of packets per field or per frame.
- VRX full: Displays the max. value of the virtual receive buffer as specified in SMPTE ST 2110-21
- TR offset: Displays the value set in TR Offset of IP SETUP2
- TRS: Displays interval read from the virtual receive buffer

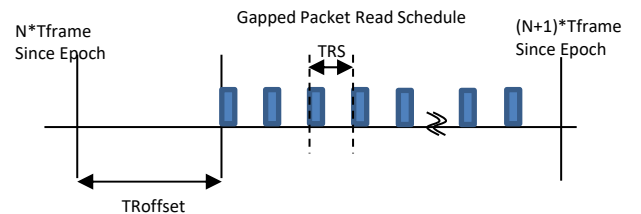
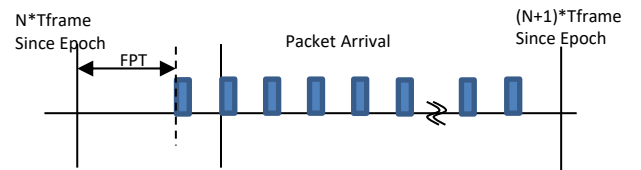

● First Packet Time (FPT) measurement

FPT displays the time from the beginning of the frame to the first packet based on SMPTE Epoch criteria; from the FPT measurement you can see when packets are being sent.

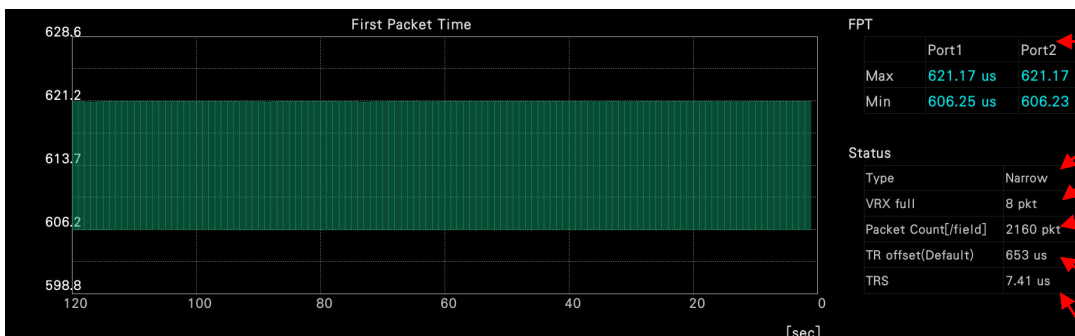

- FPT: Displays the time from the frame reference time to the first packet of the frame
- Type: Type of sender
- VRX full: Maximum virtual receive buffer
- Packet Count: Displays the number of packets per field or per frame.
- TR Offset: Offset time at which the first packet of the frame is read from the frame reference time
- TRS: Displays interval read from the virtual receive buffer

● First Packet Time (FPT) asynchronous and synchronous measurements

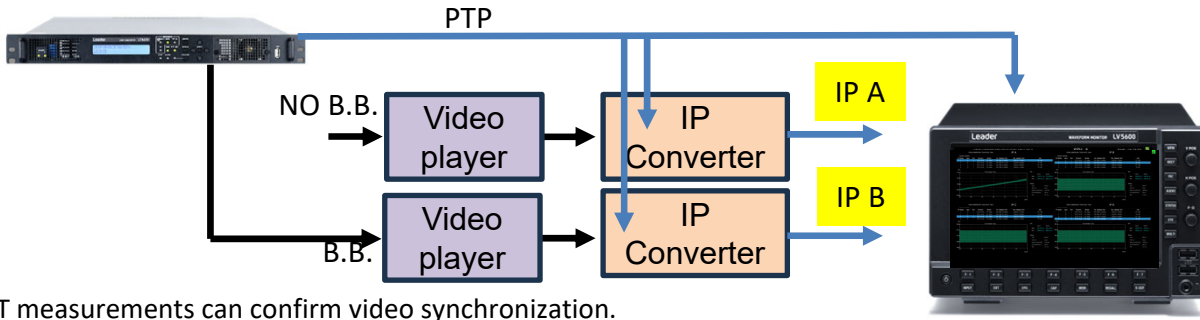

- FPT measurements can confirm video synchronization.
- The asynchronous situation causes a buffer collapse depending on the receiver design, resulting in frame skips or repeats.

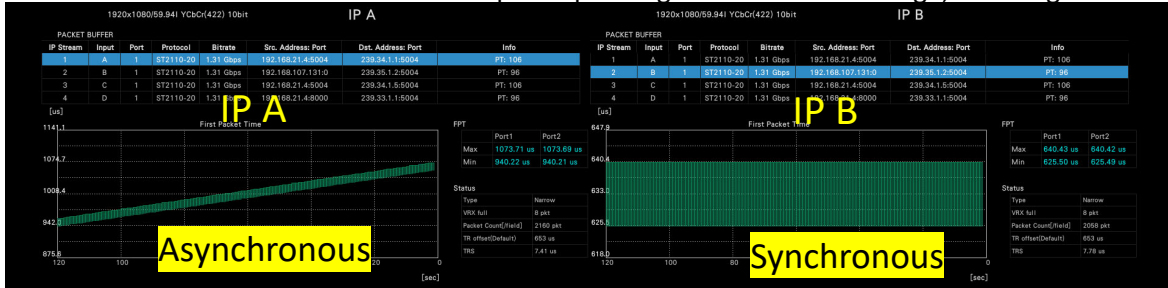

● Display of SFP information (SER05/SER06)
Displays information on installed SFP modules

- Identifier : Displays SFP Transceiver Module Type
- Connector : Displays connector type
- Transceiver : Displays SFP transceiver module standards
- Encoding : Displays encoding
- BR.Nominal Displays the transmission rate of the SFP
- Vendor Name / Vendor OUI SFP transceiver module Vendor Information
- Vendor PN / Vendor rev : SFP Transceiver Module Part Number Code and Revision Code
- Wavelength : Displays wavelength of light used in SFP Transceiver module
- Tx Power : Displays strength of light output from SFP transceivers module
- Rx Power : Displays strength of light being received by SFP transceivers module.

	Port 1	Port 2
Identifier	SFP+	SFP+
Connector	LC	LC
Transceiver	10G Base-SR	10G Base-SR
Encoding	64B/66B	64B/66B
BR.Nominal	10.3 Gbit/s	10.3 Gbit/s
Vendor Name / Vendor OUI	AVAGO / 00-17-6a	AVAGO / 00-17-6a
Vendor PN / Vendor rev	AFBR-709SMZ / G4.1	AFBR-709SMZ / G4.1
Wavelength	850 nm	850 nm
Tx Power	-2.42 dBm (573.0 uW)	-2.54 dBm (557.8 uW)
Rx Power	-2.98 dBm (503.6 uW)	-40.00 dBm (0.1 uW)

Important data for analysis because of the signal power received through the optical cable.

● NMOS SDP viewer function (SER05/SER06)
NMOS CONNECTION LIST (IS-05) screen

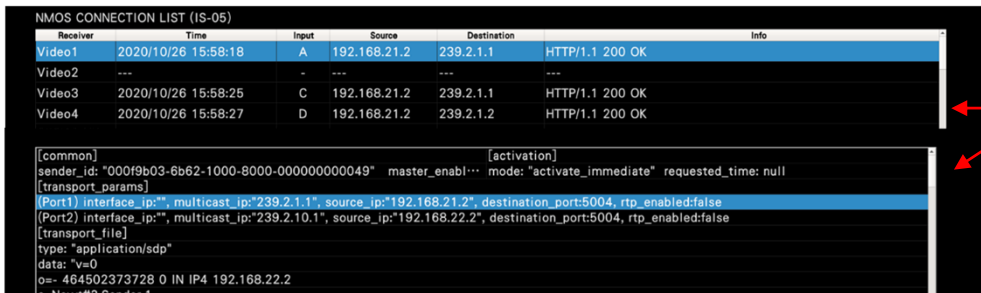

The upper part of the screen lists a partial excerpt of the request each receiver received from NMOS.
The lower part of the screen displays the requests received by the receiver selected in the upper part of the screen.

NMOS REGISTRATION LIST (IS-04) screen



The upper part of the screen lists excerpts of information on the RDS servers that the monitoring system was able to recognize on the network.
The lower portion of the screen displays the progress leading up to the RDS detection.

■ JPEG XS function (SER06)

- JPEG XS is supported by adding JPEG XS option SER33.
- Enables stream analysis and display of HD and 4K decoding.
- The JPEG XS packet header can be analyzed and displayed to check the JPEG XS format information and compression level information.

● JPEG XS STATUS

JPEG XS can check decoding status of received data, packet errors, packet volume, data volume, etc.

SMPTE ST2110-22 (JPEG XS)		JPEG XS Decode ON	
Status			
Decode Status	OK		
Format	1080/59.94P YCbCr422 10bit		
Bitrate	65.04 Mbps		
Bit per Pixel	0.50		
Data Flow Rate			
	Port1	Port2	
Packet Count(/Field)			
Max	103 pkt	103 pkt	
Min	103 pkt	103 pkt	
Payload Data(/Field)			
Max	129660 byte	129660 byte	
Min	129660 byte	129660 byte	
RTP Timestamp(/Field)			
Max	1502	1502	
Min	1501	1501	
Network			
	Port1	Port2	
Source Address	---	---	
Destination Address	239.35.1.2:5004	239.35.1.1:5004	
Packet Sequence Error	0	0	
Frame Sequence Error	0	0	
Last Packet Error	0	0	

● Format comparison display

Comparative display of formats detected by SDP, ST2110-40 (PID) and ST2110-22 (JPEG XS)

VIDEO FORMAT COMPARISON				
	Detected	SDP	ST2110-40 (Payload ID)	ST2110-22 (JPEG XS)
Image	1920x1080	1920x1080	1920x1080	---
Frame/Field Rate	59.94	59.94	59.94	29.97
I/P/PsF	Interlace	Interlace	Interlace	Interlace
SamplingStructure	---	4:2:2	4:2:2	4:2:2
Color	---	YCbCr	YCbCr	YCbCr
BitDepth	---	10	10	10
HDR/SDR	---	SDR	SDR	---
Colorimetry	---	BT.709	BT.709	BT.709

Detected: Obtained from packet data being received
 SDP: Controlled by NMOS
 ST2110-40: Payload ID embedded on ST2110-40
 ST2110-22: Packet information for JPEG XS

● Simultaneous monitoring of JPEG XS, ST2110-20 and SDI

- Simultaneous monitoring of compressed (JPEG XS), uncompressed (ST2110) and SDI
- Simultaneous monitoring enables confirmation of video quality due to compression

2K/HD Multi input & display

1	JPEG XS	1
	ST2110	1
	SDI	1
	SDI	1
2	JPEG XS	1
	SDI	1
	SDI	1
	SDI	1

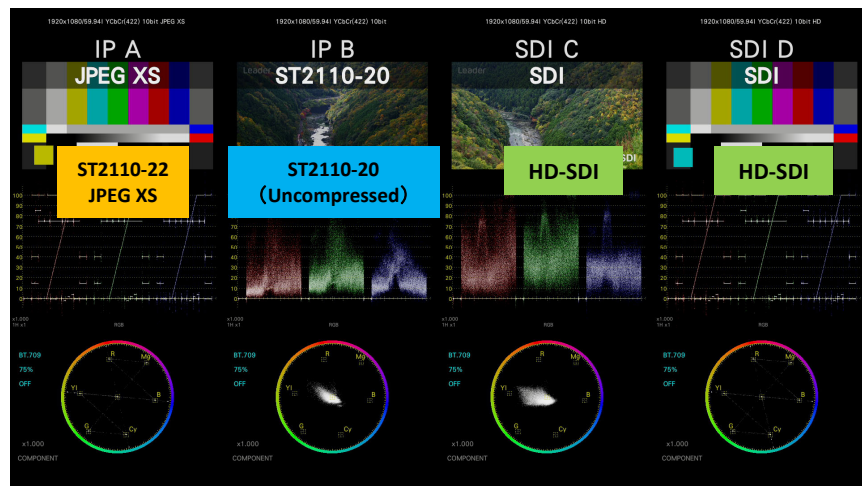

■ IP-TSG function (SER06)

- With the addition of the IP TSG option, the ST2022-6, ST2110-20/30/31/40 IP test signals are output.
- IP test signal of JPEG XS is output by adding IP TSG option and JPEG XS option.
- In an environment synchronized to PTP, the ST2110 test signal is output synchronized to PTP.





IP TSG Signal

- Support Standard
Support IP Transmission Standards(SMPTE ST 2022-6, STT2110-20/30/40)
- Format
HD, 3G, 4K
- Test pattern
Color bar, Multi color bar, Lip Sync
- Freeze Test
MOVING BOX, Scroll

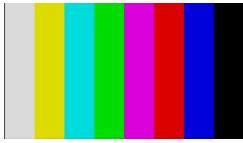

COLOR BAR



MULTI COLOR BAR



LIP SYNC



MOVING BOX



SCROLL

■ IP Audio Channel Mapping Diversified (SER06)

The audio channel mapping function allows free channel assignment of audio in 2-channel pairs.

- Mapping can be selected from Mono, Dual Mono, Standard Stereo, Matrix Stereo, 5.1ch (LCR), 5.1ch (LRC), 7.1ch (LCR), 7.1ch (LRC), 7.1.4ch (LCR), 7.1.4ch (LRC), U01 to U16 selectable.
- Mapping labels are displayed for various inputs.
- Decoded and output as AES/EBU.
- NMOS support

Ex. Mapping



Mapping label

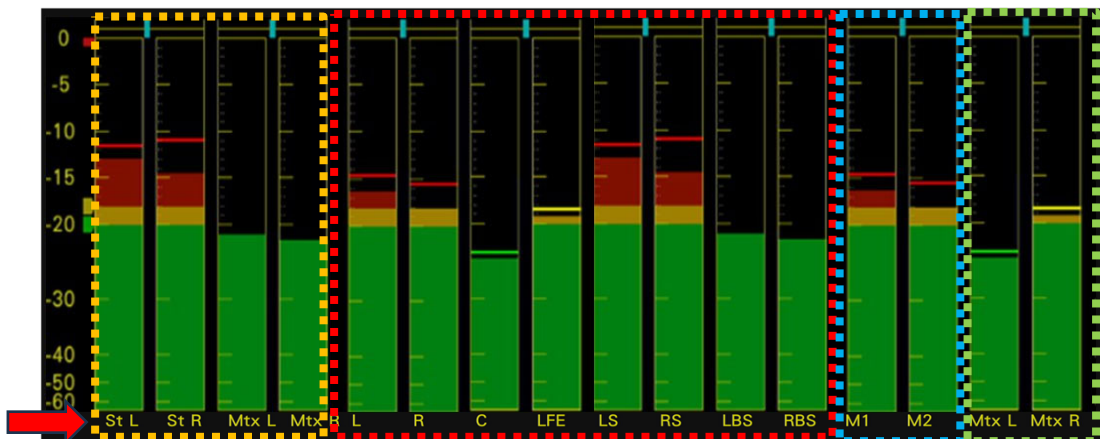

A:4ch
Standard Stereo 2ch
Matrix Stereo 2ch

B:8ch
7.1 ch(LRC)

C:2ch
Dual Mono

D:2ch
Matrix Stereo 2ch

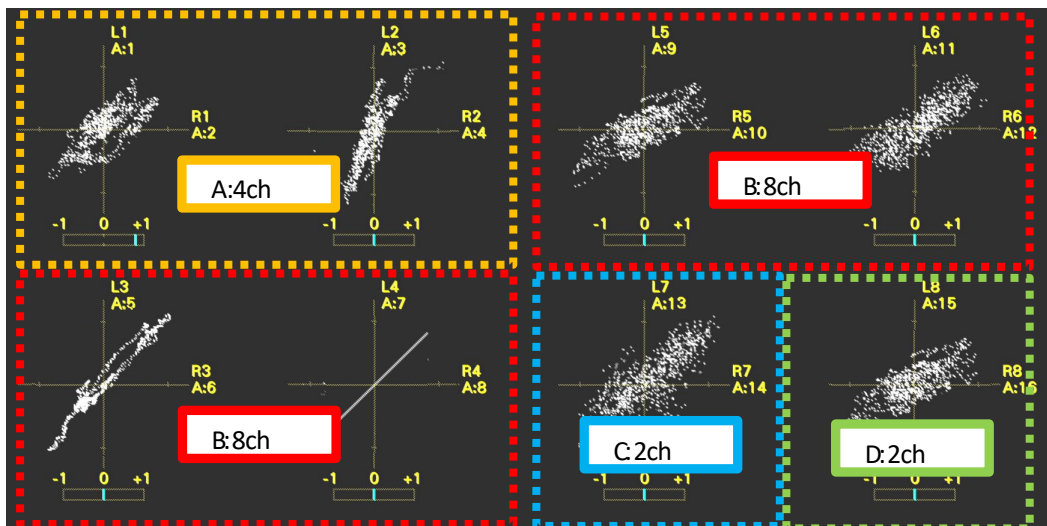

LVB440 IP ANALYZER

Ultimate IP Analysis and Monitoring

Supports 4K uncompressed



- 8K 4K HD SD
- ST2110 ST2022-6 IP-TSG
- Dual 60G Dual 40G Single 80G



The LVB440 dual 40 gigabit Ethernet IP probe monitors high-bitrate IP broadcast media traffic from outside production studios, broadcasting networks, and master control centers, enabling quick troubleshooting and quality assurance. The LVB440 supports both ST2110-20 and ST2022-6 uncompressed and ST2110-22 JPEG XS compression with dual 40 gigabit bit rate inputs, delivering a real-time analysis solution for broadcast stations and network operators handling large numbers of streams. Uncompressed video and audio packets can be analyzed with microsecond accuracy. Up to eight clients can simultaneously view analysis data on standard Web browsers or the optional aluminum kit.

- 10, 25, 40, 50 and 100 gigabit on dual interfaces.
- Simultaneous analysis of multiple 4K, 3G, HD, and SD IP streams.
- Supports uncompressed 4K/3G/HD/SD and compression(JPEG XS) 4K/3G/HD.
- Continuously surveys all layers of media transport on an IP network and allows quick identification of potential problems.
- Maximizes Quality of Service (QoS).
- Provides remote monitoring via browser with support of up to eight simultaneous users.
- Outputs ST2110-20/30/40 compatible IP signals

Options

Model number	Product name	Function
LVB440-SER21	40Gbps-OPT	40Gbps can be added to support up to 60Gbps for dual and 80Gbps for single.
LVB440-SER22	JPEGXS-OPT	JPEG XS decoding option. Can be evaluated using vector and image display.
LVB440-SER23	GEN5-OPT	Outputs ST2110-20/30/40 compatible IP signals. ST2110-20 compatible formats are 4K and HD.
LVB-SW3	Software Maintenance	3-year software maintenance and version upgrade support
LVB-SW5	Software Maintenance	5-year software maintenance and version upgrade support

Basic operation

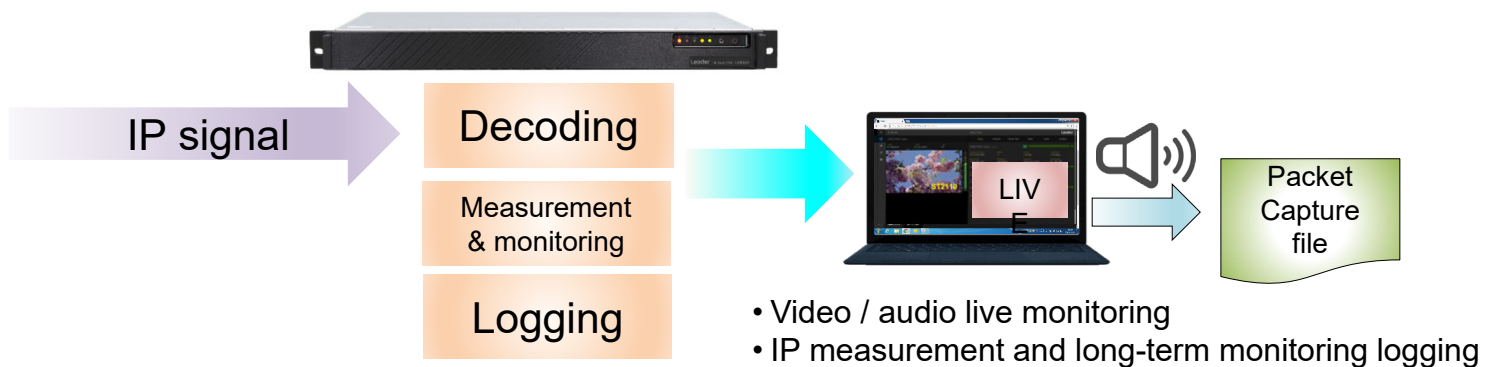

LVB440 REAR PANEL

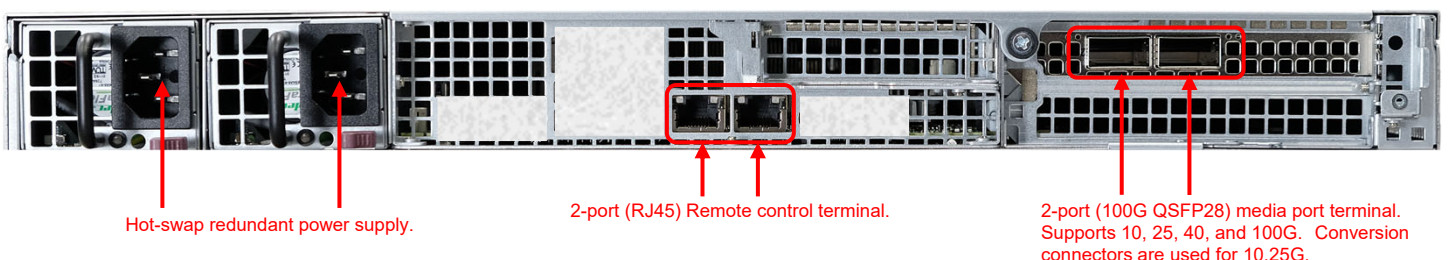

Technical Information

■ Status confirmation screen

Video format, error count, bit rate, packet rate, angle of view, frame rate, color system support standard, audio bar, and time code can be checked.



■ PAI Measurement

Supports measurement of packet arrival interval time (PAI) of IP signals and ratio of redundant signals

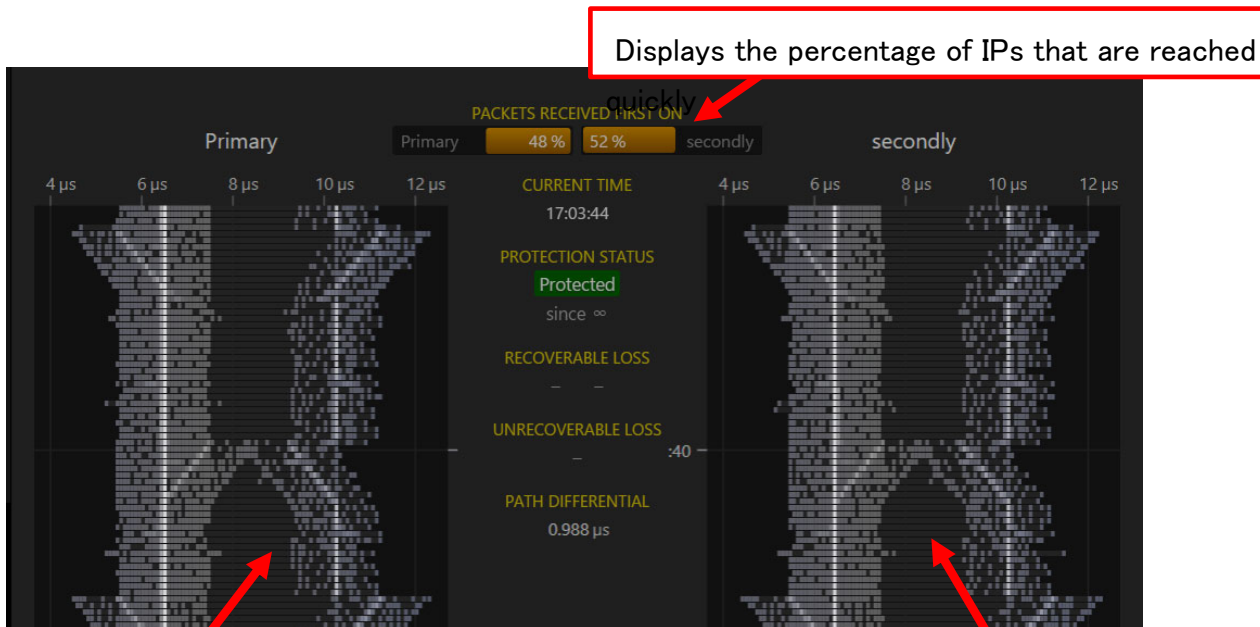

Display Packet arrival interval of Primary

Display Packet arrival interval of Secondary

■ Timing measurement

By comparing the time information and timestamp of the PTP, video, audio, and ANC signals are synchronized with the PTP by comparing the time information and timestamps of the PTP. Timing measurement can check Path delay, RTP Align offset, RTP frequency offset, First packet time and FPT margin. Virtual Receive Buffer can check VRX, VRX underflow and VRX overflow. Network Burstiness can check C and C overflow.



■ Maximum Streams

The number of measurement/monitoring streams can be input up to the maximum bandwidth. For example, the ST2110-20, 1920X1080 59.94I, has a transmission rate of 1.31Gbps per stream. With two SFP ports, the standard specification allows up to 30 streams per port; with the optional addition of two SFP ports, up to 45 streams per port; and with one SFP port, up to 61 streams can be measured and monitored simultaneously. Translated with www.DeepL.com/Translator (free version)

ST2110-20

Format	Frame Rate	Stream Gbps	Standard 2 SFP (40GbpsX2)	+OP G40 2 SFP (60GbpsX2)	+OP 40G 1 SFP (80GbpsX1)
3840X2160	59.94P	10.4	3	5	7
3840X2160	50.00P	8.71	4	6	9
1920X1080	59.94P	2.61	15	22	30
1920X1080	50.00P	2.18	18	27	36
1920X1080	59.94I	1.31	30	45	61
1920X1080	50.00I	1.09	36	55	73
1280X720	59.94P	1.16	34	51	68
1280X720	50.00P	0.86	46	69	93

ST2022-6

Format	Frame Rate	Stream Gbps	Standard 2 SFP (40GbpsX2)	+OP G40 2 SFP (60GbpsX2)	+OP 40G 1 SFP (80GbpsX1)
1920X1080	59.94I	1.55	25	38	51
1920X1080	50.00I	1.55	25	38	51
1920X1080	59.94P	3.1	12	19	25
1920X1080	50.00P	3.1	12	19	25

■ Multi-display with Widglets function

By creating HTML5, you can freely create screen layouts.

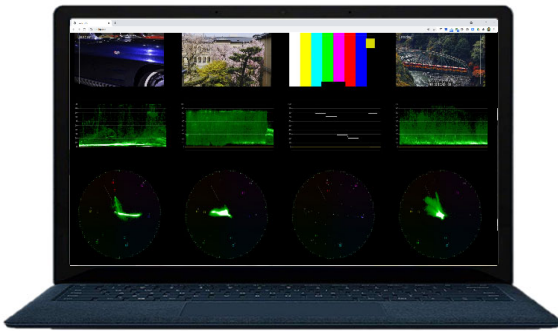

Multi-display with Widglets function.

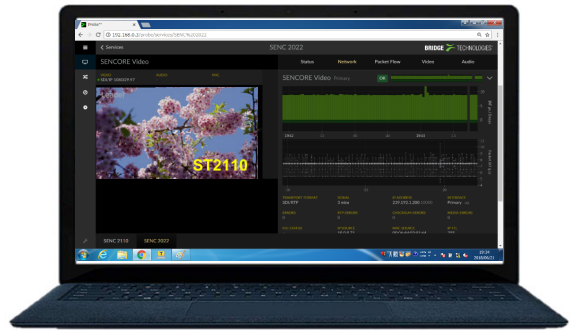

Measurement and analysis, etc.

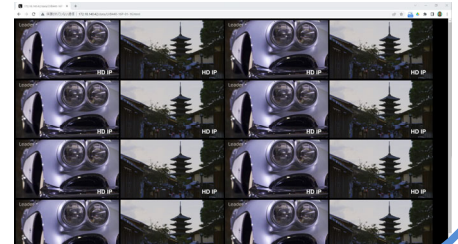
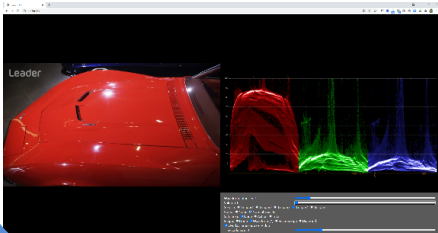
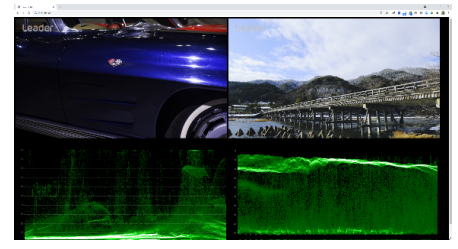
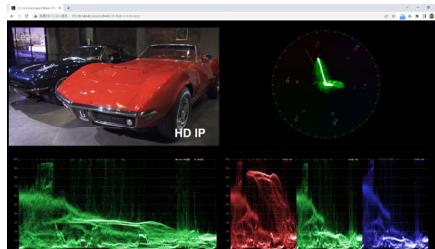
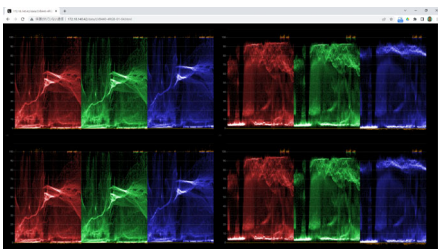
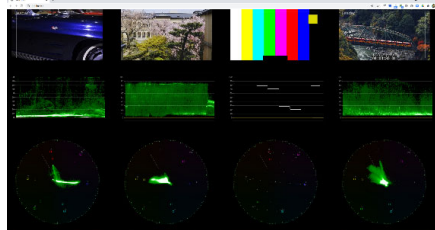

Sync Generator LT4670

PTP, GNSS, IP-TSG, Timecode,
Hot-swappable dual power supplies



The LT4670 is a Sync Generator. It has a hot-swap dual redundant power supply for maximum reliability. It will support ground master PTP and also PTP follow (slave). 6 independent analog syncs, word clocks signal outputs, and AES/EBU outputs. The genlock function provides a STAY-IN-SYNC function that maintains the phase when an error occurs in the input signal, enabling a highly stable system. IP and 12G-SDI TSG output is available with the addition of an IP/12G option. Two LT4670s with L-Sync function enables time synchronization between two LT4670s. Optional SDI (4K / 3G-SDI / HD-SDI / SD-SDI) signal, GPS, and PTP generation are provided.

Dimensions (W x H x D inches/mm) – 1U size type
19 x 1.7 x 16 (inches) / 482 x 44 x 400 (mm)

PTP GNSS GENLOCK BB Tri-level WC AES/EBU
LT4670 Configuration 4K IP TSG 12G SDI 3G SDI HD SDI SD SDI C

model number	name	Feature
LT4670	SYNC GENERATOR	Genlock 6 outputs Analog reference (BB/3 values) 1 output Word clock 1 output AES/EBU audio output 1 output AES/EBU silent audio output TIME CODE Generator CW input/output/1PPS output LTC input/output L-Sync Standard 1 power supply unit
LT4670-SER01	GNSS	GPS, GLONASS, GALILEO, BDS compatible
LT4670-SER02	SDI	2 outputs 3G/HD/SD SDI pattern output 4 user patterns(BMP or TIFF file) <small>*Maximum of two can be mounted.</small>
LT4670-SER03	PTP	PTP support (Leader, Follower)
LT4670-SER04	25G IP 12G TSG	4 outputs 12G/3G/HD/SD SDI, IP 25G/10G pattern output
LT4670-SER11	POWER	Power supply unit for redundant applications <small>*Additional units to be added as redundancy.</small>
LT4670-SER21	4K Quad Link	4K Quad output <small>Two *LT4670-SER02 are required.</small>

● Configuration

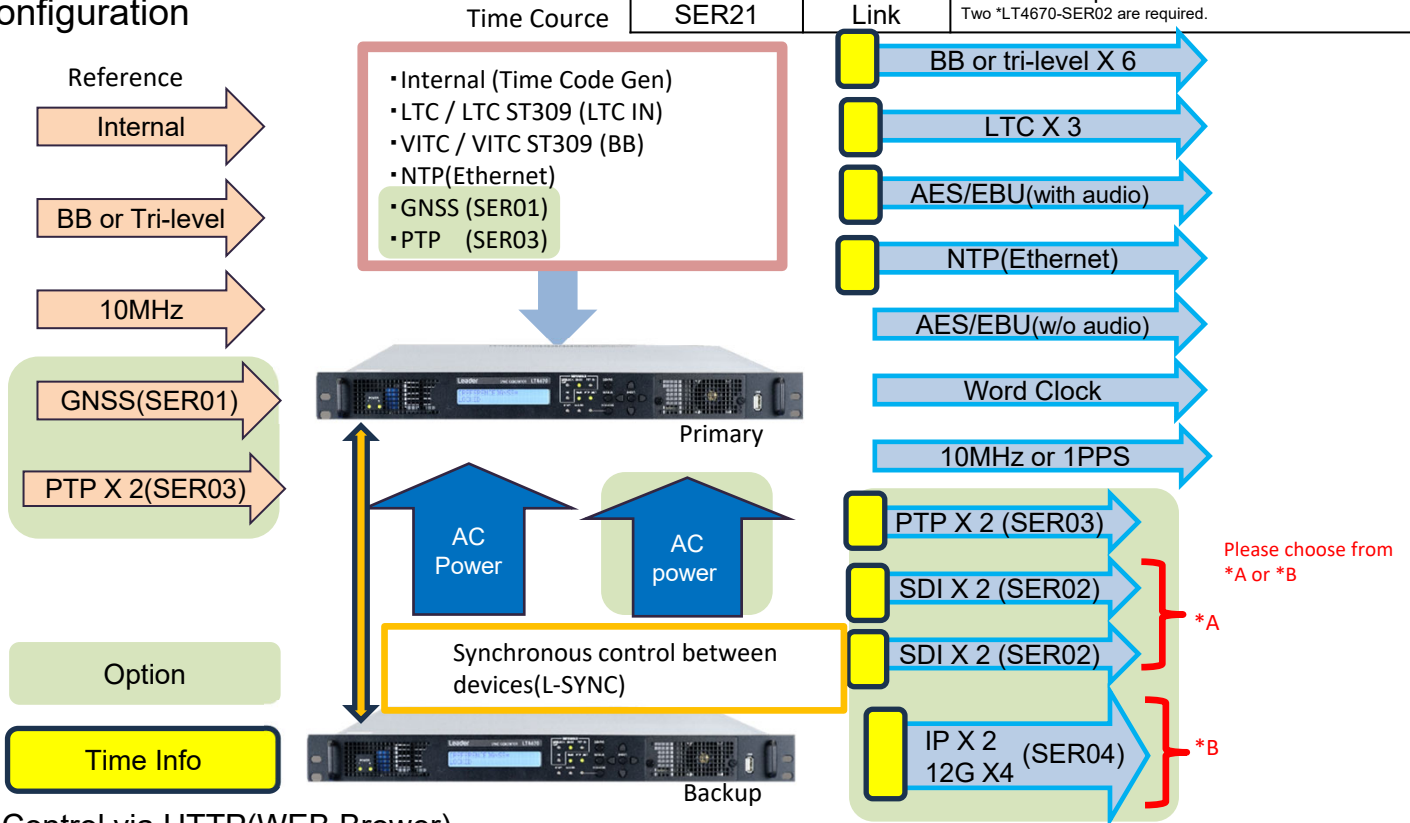

● Control via HTTP(WEB Brower)

Settings can be made from a browser via an Ethernet connection. Information displayed on the LEDs on the panel is also displayed in real time on the browser.

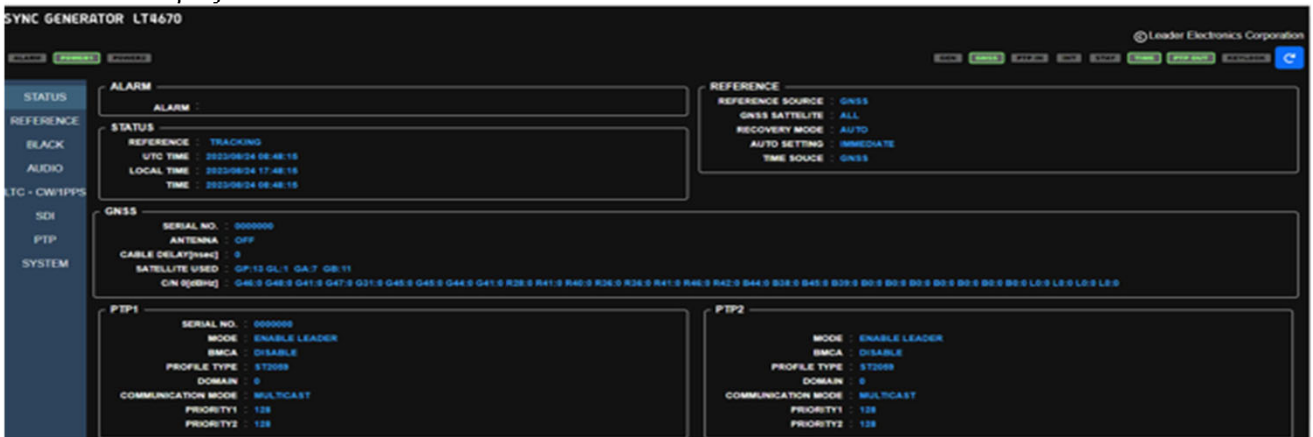

● Rear panel of LT4670

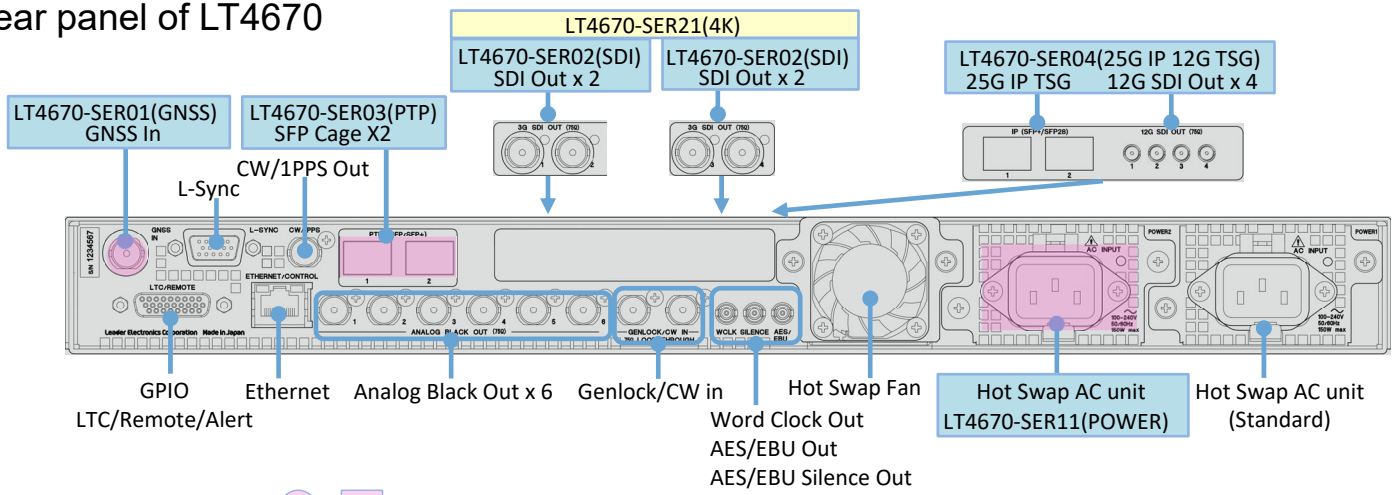

● ■ If no options are added, no connectors are implemented.

Hardware Options

- LT4670-SER01 GNSS
- LT4670-SER02 SDI (2 outputs)
- LT4670-SER03 PTP
- LT4670-SER04 25G IP 12G TSG
- LT4670-SER11 POWER

Software Option

- LT4670-SER21 4K 3G Quad Link

● Synchronous control between two devices(L-SYNC)

L-SYNC synchronizes the time of the two units
 Primary and Backup output the same timing
 The same timing is output when switching from Primary to Backup due to the Primary signal failure in the changeover input

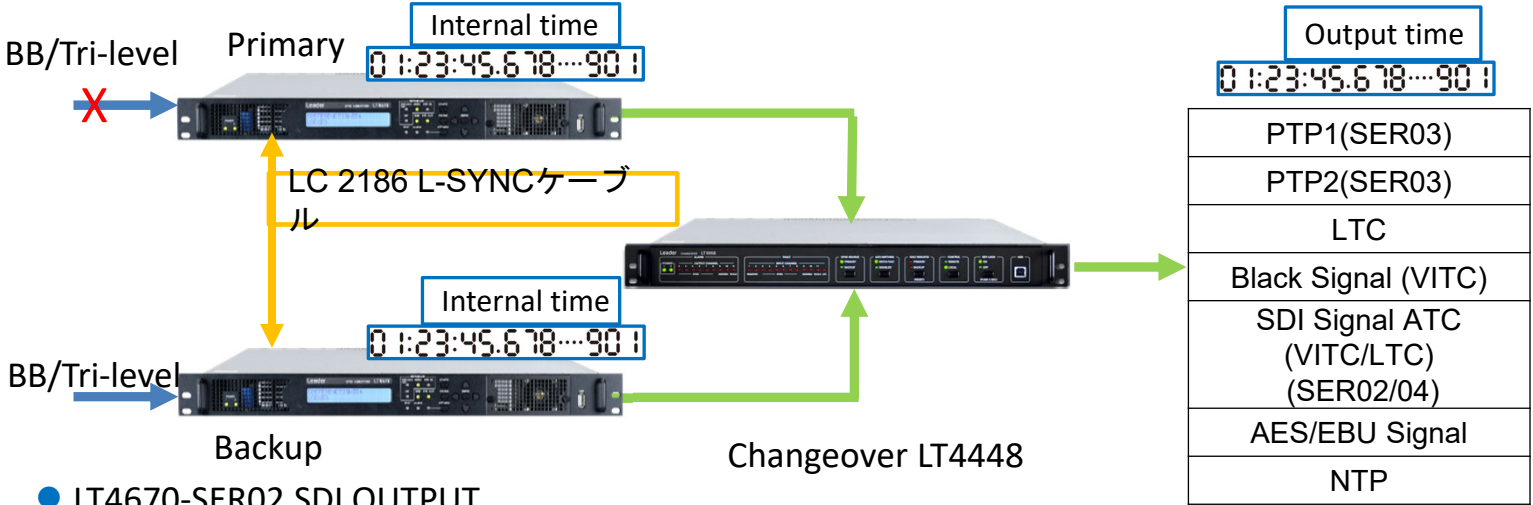

● LT4670-SER02 SDI OUTPUT

- Many combinations of confirmation functions are available.
- Up to 4 Users pattern(BMP/TIFF files) can be registered.



User pattern

Confirmation function combination

● Independent PTP Network

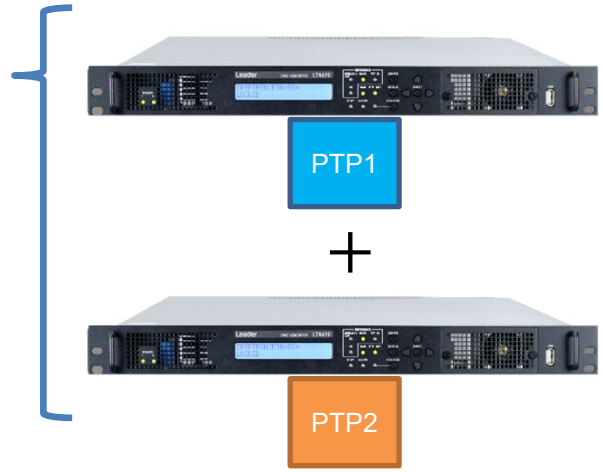
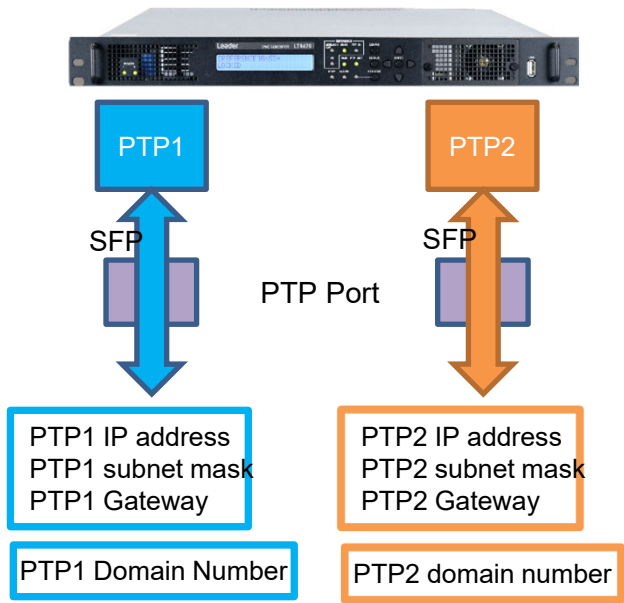

- Thanks to two independent PTP engines, you can build two independent ground master system of PTP.
- On the PTP, it is identical as having two LT4670s.
※Redundancy cannot be built with a single unit since there is only one standard for GNSS, etc.

● Independent PTP network use case

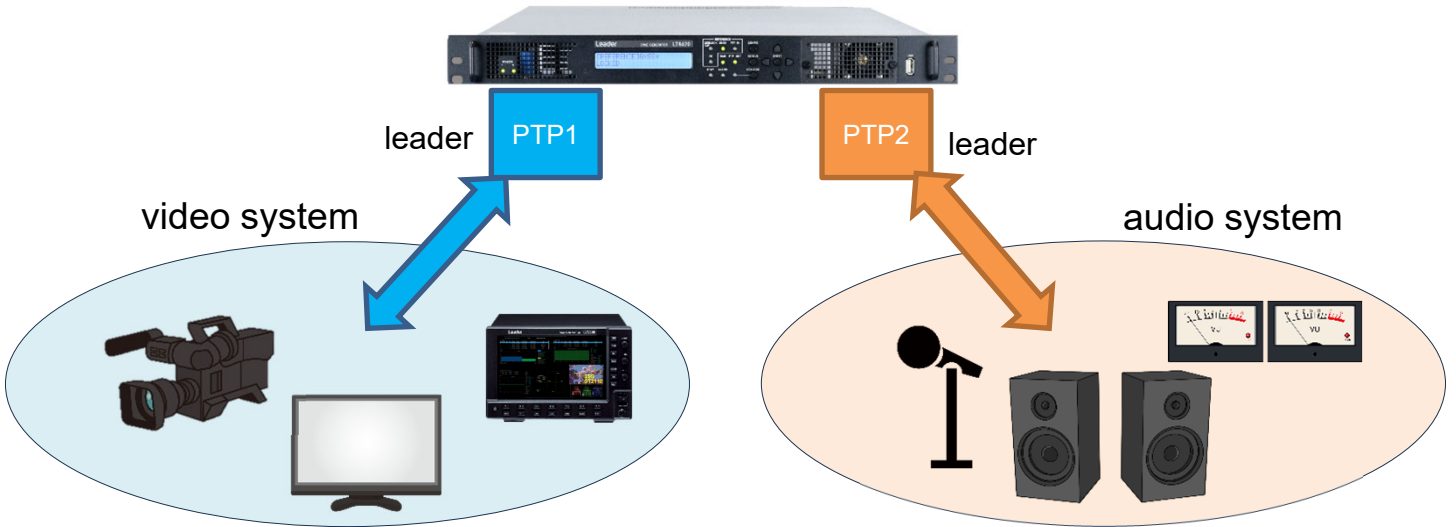

● Set 2 systems as followers

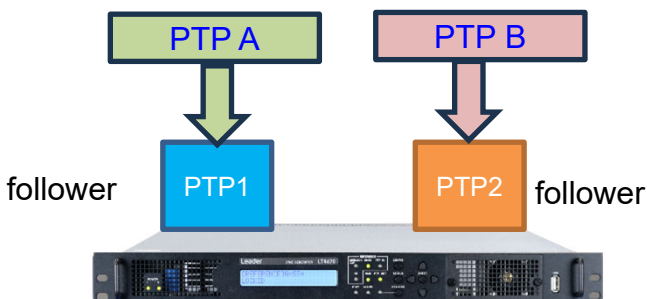

BB / 3 tri-level sync
10MHz CW / 1PPS
WC / AES_EBU
SDI(SER02/04)
IP TSG (SER04)

Followers will be automatically selected.

● Leader and follower settings

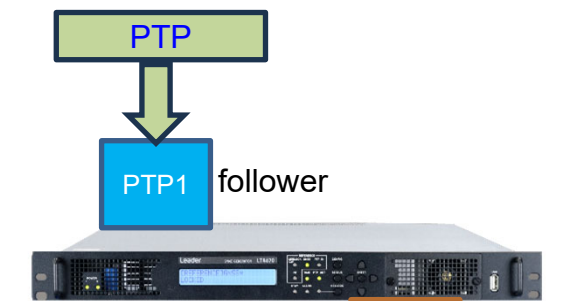

BB / 3 tri-level sync
10MHz CW / 1PPS
WC / AES_EBU
SDI(SER02/04)
IP TSG (SER04)

PTP and other outputs synchronized to followers is possible.

- BMCA linked (PTP LINKED)

- The analog sync signal output can be set to stop in conjunction with the PTP BMCA.
- When stopped, the LT4448 (changeover) operates and the connected BB or SDI switches to BACKUP.

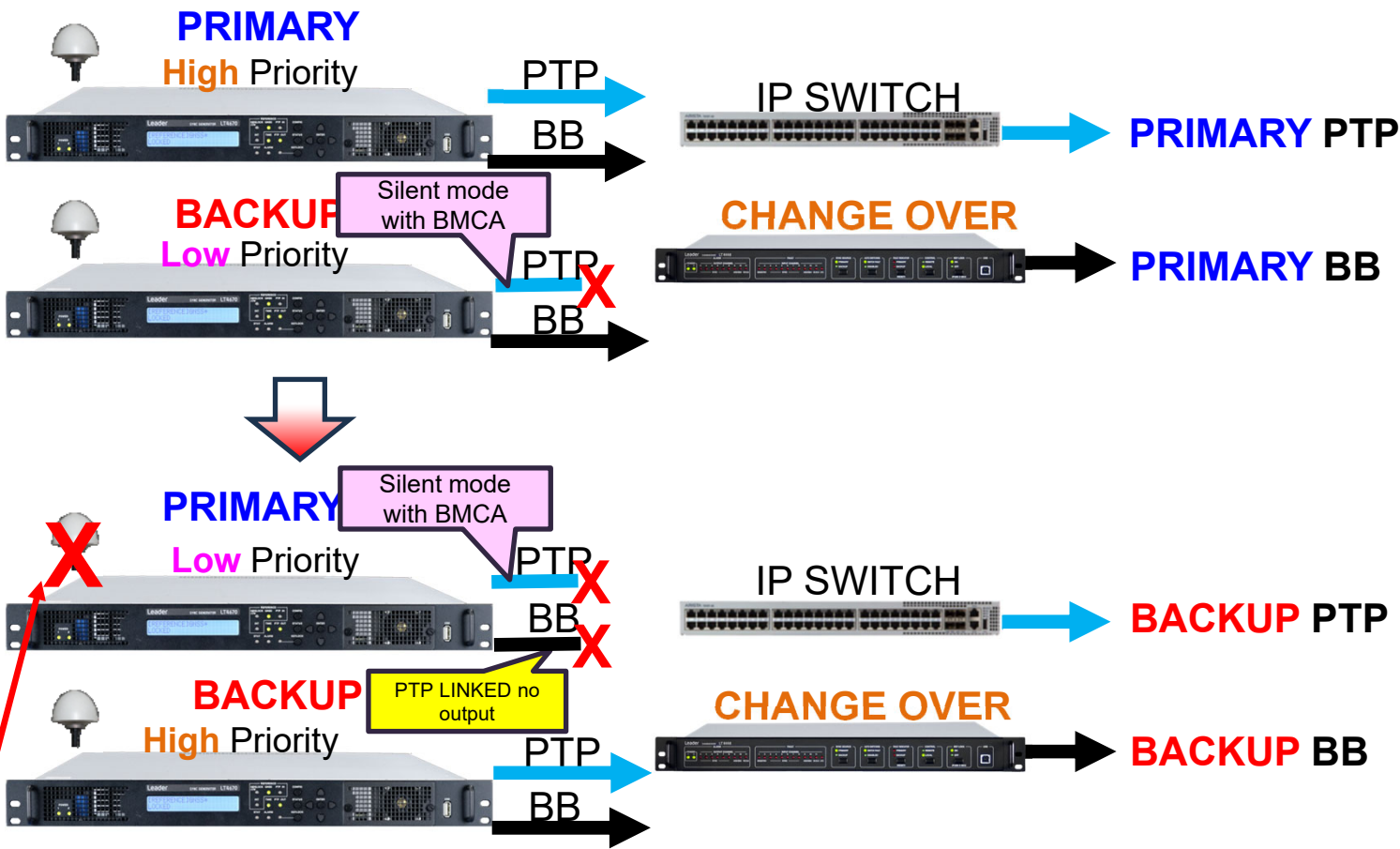

Example:
If a GNSS failure occurs, the Primary priority changes to Low and the PTP BMCA is activated.

- LT4670-SER02 SDI OUTPUT 4 outputs 12G/3G/HD/SD SDI, IP 25G/10G pattern output

25G IP signal generation function
Supports SMPTE ST 2110-20/30/31/40, and can generate 2K and 4K (3840x2160) video signal test patterns.

12G-SDI (4K) support
Supports 12G-SDI, 3G-SDI (Level A, Level B), HD-SDI, and SD-SDI. The SDI signal output terminal has four independent output systems, and the pattern and phase can be set for each.

User pattern output
File format: 24-bit full color bitmap format (.bmp), 24/48-bit TIFF format (.tif) uncompressed files are built-in and can be used as patterns.

Output Combinations

IP output can output up to 2 channels per port, multiplexing the same pattern as the SDI output.

- Example
- 12G-SDI output1 (4K Multi-color bar)
 - 12G-SDI output2 (4K User pattern)
 - 12G-SDI output3 (HD User pattern)
 - 12G-SDI output4 (HD 75% Color bar)
 - IP 1port (4K Multi bar & HD User pattern)
 - IP 2port (4K User pattern & HD 75% Color bar)

LT4670-SER04(25G IP 12G TSG)
IP TSG 12G-SDI Out x 4
(SFP cage) (small BNC)

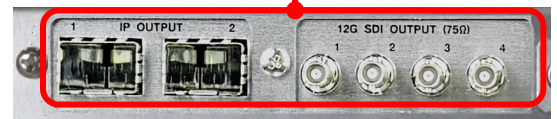

LT4600A

3GSDI HDSDI SDSDI BB

Multi Format Video Generator



Compact, 1U half rack size
supports triple-rate SDI

The LT 4600A multi-format video generator is a compact, 1U half-rack size SDI video signal generator that supports the triple-rate SDI (3G-SDI/HD-SDI/SD-SDI) format. In addition to test pattern output including color bars and SDI check fields, the LT 4600A is equipped with numerous other features such as ID characters, QVGA logo marks, safety area markers, audio embedding, genlock for external reference input signals, and three analog black signal outputs.

Dimensions (WHDmm) : 213x44x400 (1U half size type)

LT4448

3GSDI HDSDI SDSDI BB LTC

Changeover



For LT4670 / LT4600A

The LT4448 is equipped with 11 inputs / outputs, (PRIMARY, BACKUP, OUTPUT), plus LTC, and utilizes 2 input switching relays and 9 electronic switches. SDI, NTSC / PAL black burst, HD Tri-level Sync, AES / EBU digital audio, word clock, and LTC signals are supported. Faults are easily identified on the LED panel. The power supply is duplexed, with alarm notification of faults, and SNMP is also supported. Designed to be used in combination with LT4670, LT4610, LT4611 and LT4600A.

Dimensions (WHD mm): 426x44x400 (1U size type)

●LT4600A MULTI FORMAT VIDEO GENERATOR

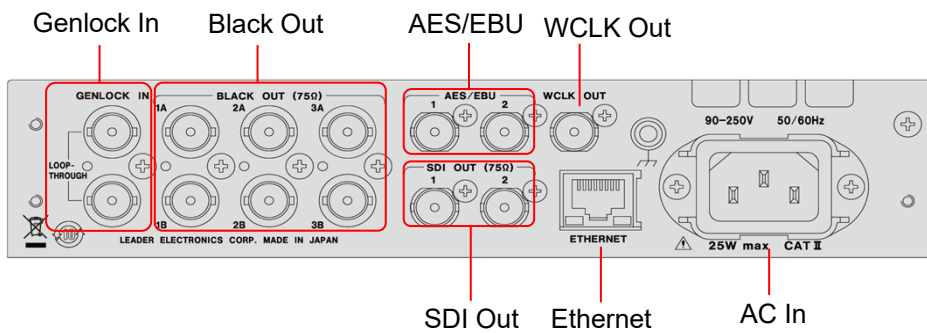

■Lip Sync (Applicable models: LV5900A, Zen series, LT4670(with SER02 or SER04) and LT4600A)

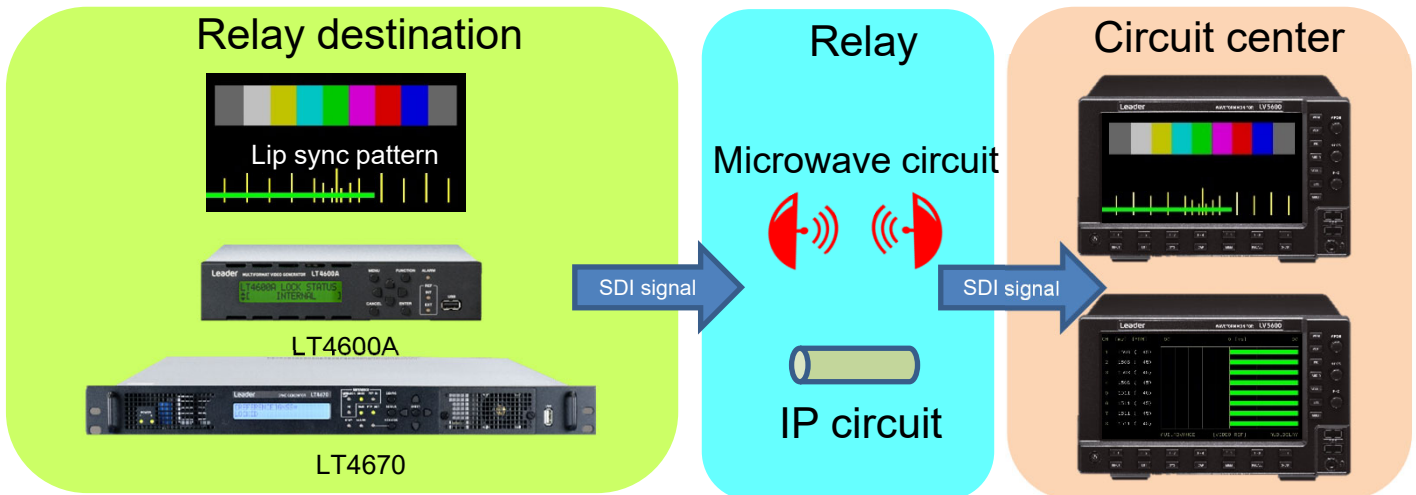

- Measures the time difference between audio and video signals.
- Can measure video and audio delays in microwave circuits and IP circuits during relay.
- Fluctuations in IP lines and the like are easy to identify.
- Measurement resolution: 1 ms
- Measurement system requirements

Measurement system consisting of LV5600-SER03/LV7600-SER03 (DIGITAL/ANALOG AUDIO) installed in the LV5600W/LV7600W or the LV5300-SER20/LV5350-SER20/LV7300-SER20 (AUDIO) installed in the LV5300A/LV5350/LV7300 and combined with the LT4670(with SER02 or SER04) or LT4600A.

Accessory



LR2561 Rack Mount Adapter

The LR2561 is a dual rack mount adapter for mounting the LV5600W wave monitor in a 19-inch EIA standard rack. The LV5300A or LV5350 can also be mounted on the right side.

Compatible model: LV5600W



LC2566 Blank Panel

LC2566 is a blank panel for the LR2561 rackmount adapter, for use when only one LV5600W waveform monitor is to be mounted on the LR2561.

Compatible model: LV5600W



LR2530 Rack Mount Adapter

The LR2530 is a dual rackmount adapter for mounting the LV5300A / LV5350 waveform monitor in a 19-inch EIA standard rack, allowing two LV5300A/LV5350 units to be mounted side by side.

(LV5300A + LV5350 dual-unit requires separate optional support.)

Compatible models: LV5300A/LV5350



LC2535 Blank Panel

LC2535 is a blank panel for the LR2530 rackmount adapter.

Use when mounting only one waveform monitor LV5300A/LV5350 on LR2530.

Compatible models: LV5300A/LV5350



LR2490 Rack Mount Adapter

The LR2490 is a dual rackmount adapter for mounting the LV5900A wave monitor in a 19-inch EIA standard rack, allowing two LV5900A units to be mounted side by side.

Compatible model: LV5900A



LC2190 Blank Panel

LC2190 is a blank panel for the LR2490 rackmount adapter, to be used when only one LV5900A waveform monitor is to be mounted on the LR2490.

Compatible model: LV5900A

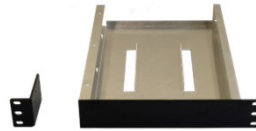

LR2731 Rack Mount Adapter

LR2731 is a rack mount adapter to be used when mounting the LV7300 rasterizer in a 19-inch EIA standard rack. Since one side is a blank panel, use it when mounting only one LV7300 unit.

Compatible model: LV7300



LR2732 Rack Mount Adapter

The LR2732 is a dual rack-mount adapter for mounting the LV7300 rasterizer in a 19-inch EIA standard rack, allowing two LV7300 units to be mounted side by side.

Compatible model: LV7300



LR2478 Rack Mount Adapter

The LR2478 is a dual rackmount adapter for mounting our 1U half-rack size products in a 19-inch EIA standard rack, allowing two units to be mounted side by side.

Compatible model: LT4600A



LR2481 Rack Mount Adapter

The LR2481 is a rackmount adapter for use when mounting our 1U half-rack size products in a 19-inch EIA standard rack. One side is a blank panel.

Compatible model: LT4600A



GST90A12 AC adapter

AC adapter for LV5300A/LV5350/LV7300 only; AC cord is included; Supplied for LV7300 as standard. Not included for LV5350/5300A

Compatible models: LV5300A/LV5350/LV7300



SFP Transceiver RJ-45

Model Number: LC2142
Function: 1000BASE-T
Compatible model: LT4670-SER03



10GE SFP Transceiver Optical (MMF)

Model Number: LC2148
For short distance Max. 300m
Function: 850 nm, 10GBASE-SR/SW
Supported models:
LV5600-SER05,SER06
LV7600-SER05,SER06
LT4670-SER03,SER04



10GE SFP Transceiver Optical (SMF)

Model Number: LC2149
For long distance up to 10,000m
Function: 1310nm, 10GBASE-LR/LW
Supported models: LV5600-SER05,SER06/
LV7600-SER05,SER06/
LT4670-SER03,SER04



25GE SFP28 Transceiver Optical (MMF)

Model Number: LC2151
For long distance up to 70 m (OM3),
up to 100 m (OM4)
Function: 850 nm, 25GBASE-SR
Compatible model: LV5600-SER06/
LV7600-SER06/
LT4670-SER04



25GE SFP28 Transceiver Optical (SMF)

Model number: LC2152
For long distance up to 10,000m
Features: 1310nm, 25GBASE-LR
Compatible model: LV5600-SER06/
LV7600-SER06/
LT4670-SER04



LC2185 Cable for LTC connection

Conversion cable (1.5m) between 25-pin D-sub LTC connector on LT4448, two 26-pin D-sub LTC connectors for LT4670 PRIMARY and BACKUP, and three XLR connectors for LTC output
Compatible models: LT4670/LT4448



LC2186 L-SYNC Cable

Time synchronization is possible by connecting two LT4670 units.
*When using 2 units with genlock
Compatible model: LT4670



POWER

Model Number: LT4670-SER11
Power supply unit for redundant applications
Compatible model: LT4670



Maintenance Parts Fan Unit

Model number: LP2184
Front and rear FAN sets
Hot-swappable
Compatible model: LT4670



GPS antenna set

ModelNumber:
AU-217A-SET
A set of antenna and mounting hardware that allows you to lock the LT4670 with GPS.

Compatible model:
LT4670-SER01



Desktop kit for LV5600W

Model number: LC2191
Handles and stand for portability
Compatible model: LV5600W

Accessory List

PRODUCT NAME	MODEL	APPLICABLE MODEL	REMARKS
RACK MOUNT ADAPTER	LR2561	LV5600W	Rack mount adapter for LV5600W
RACK MOUNT ADAPTER	LR2530	LV5300A/LV5350	Rack mount adapter for LV5300A/LV5350
RACK MOUNT ADAPTER	LR2490	LV5900A	Rack mount adapter for LV5900A
RACK MOUNT ADAPTER	LR2731	LV7300	Rack mount adapter for LV7300 (one rasterizer)
RACK MOUNT ADAPTER	LR2732	LV7300	Rack mount adapter for LV7300 (two rasterizer)
RACK MOUNT ADAPTER	LR2478	LT4600A	Rack mount adapter for LT4600A (two LT4600A)
RACK MOUNT ADAPTER	LR2481	LT4600A	Rack mount adapter for LT4600A(one LT4600A)
BLANK PANEL	LC2566	LV5600W	Blank panel for Rack mount adapter LR2561
BLANK PANEL	LC2535	LV5300A/LV5350	Blank panel for Rack mount adapter LR2530
BLANK PANEL	LC2190	LV5900A	Blank panel for Rack mount adapter LR2490
DESKTOP KIT	LC2191	LV5600W	Handles and stand for LV5600W
AC ADAPTER	GST90A12	LV5300A/LV5350/LV7300	10GE, 850nm, 10GBASE-SR/SW
SFP TRANSCEIVER RJ-45	LC2142	LT4670-SER03	1000BASE-T
SFP+ MULT-MODE	LC2148	LV5600-SER05/ LV7600-SER05/ LT4670-SER04	10GE, 850nm, 10GBASE-SR/SW
SFP+ SINGLE-MODE	LC2149	LV5600-SER05/ LV7600-SER05/ LT4670-SER04	10GE, 1310nm, 10GBASE-LR/LW
SFP28 MULT-MODE	LC2151	LV5600-SER06/ LV7600-SER06/ LT4670-SER04	25GE, 850nm, 25GBASE-SR
SFP28 SINGLE_MODE	LC2152	LV5600-SER06/ LV7600-SER06/ LT4670-SER04	25GE, 1310nm, 25GBASE-LR
LTC CABLE	LC2185	LT4448	Two 26-pin D-sub LTC connectors for LT4670 PRIMARY and BACKUP, and three XLR connectors for LTC output
L-SYNC CABLE	LC2186	LT4670	Time synchronization is possible by connecting two LT4670 units
POWER	LT4670-SER11	LT4670-SER01	Power supply unit for redundanttv applications
MAINTENANCE PARTS FAN UNIT	LP2184	LT4670	Front and rear FAN sets (Hot-swappable)
GPS ANTENNA KIT	AU-217A-SET	LT4670-SER04	A set of antenna and mounting hardware that allows you to lock the LT4670 with GPS (Cable not included)

LeaderPhabrix **Introducing the LPX500 Waveform Monitor**

Quad-input Waveform Monitor with Dual-independent displays for Hybrid IP/SDI workflows



The LPX500 Hybrid IP/SDI waveform monitor is the first in a powerful new family of video analysis and generation instruments, encompassing next generation technology from the renowned Leader and PHABRIX Test and Measurement brands. The LPX500 offers a bank of four autonomous analyzers, enabling the simultaneous display of four 4K SDI or IP video source inputs.



Re-designed, compact form factor

Housed in a fully re-designed and compact form factor, the LPX500 offers an 8-inch touchscreen and short depth, ideal for locations with limited rack space, including OB trucks. An independent second compact 8-inch touchscreen display is also offered via a dedicated USB-C connection. Using its built-in noVNC, the LPX500 also offers fast access to both displays over a remote network.



Quad 12G-SDI and dual 100GE-IP inputs

Supplying a bank of four autonomous analyzers, the LPX500 enables the simultaneous display of four 4K inputs, HDR and SDR inputs or even SDI and IP inputs. The instrument offers a 10G-IP toolset with dual SDI analyzer support as standard, and advanced Physical Layer Analysis (Eye and Jitter) offered as factory fitted options. The LPX500's comprehensive feature-set is designed to support SD/HD/3G/6G/12G-SDI, 10GE/25GE/100GE IP interfaces with SD/HD/UHD, SMPTE 2022-6, SMPTE ST 2110-10/20/30/31/40 with ST 2022-7, and AMWA NMOS. Optional software licenses can also be added for SDI/IP AV Test Signal Generation, UHD/4K support, HDR, EUHD (47.95-60p RGB YCbCr 444 formats), 25GE and 100GE IP support.

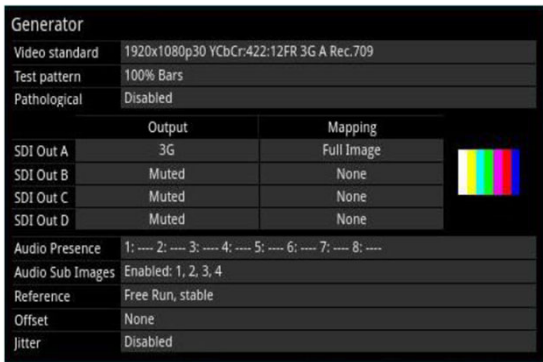

Up to 100G-IP/12G-SDI Audio & Video Generation and Analysis

Generate and analyze a comprehensive set of SDR/HDR, YCbCr/RGB, HD/3G/6G/12G SDI and HD/3G/6G/UHD/EUHD IP Formats. The LPX500 can simultaneously generate and analyze 1x ST 2110-20 video, 4x ST 2110-30/31 audio and 1x ST 2110-40 ANC.

In ST 2022-7 mode, LPX500 compares the video, audio and ANC flows from A & B networks. LPX500 can also generate the instrument display as 1 x ST 2110-20 and 1 x 2110-30 flows for access by remote monitoring locations. The SDI pattern-set offers up to 32 channels of embedded audio per link or subfield (up to 64 channels on 12G interfaces) and core full screen SDI Pathological stress patterns as well as allowing the user to define conventional generator patterns up to full frame.

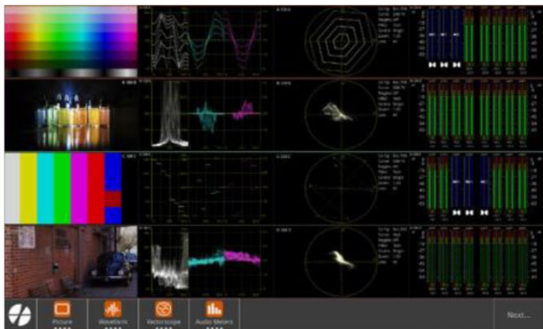

Powerful enhanced instrument layouts

Enhanced layouts not only extend the available screen real estate but now feature swipe gestures to navigate through configured layouts. Multiple screen layouts provide a huge canvas of extended screen real estate to move smoothly between up to 16 layouts, optimizing the viewing and touch experience on the unit.

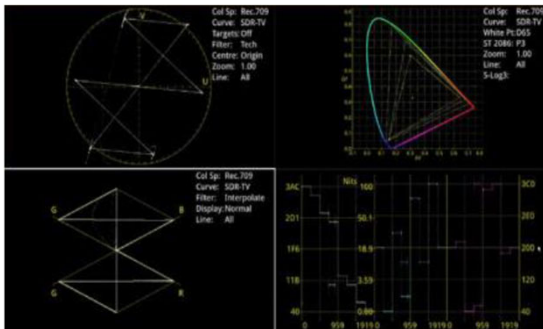

Out-of-the-box Video and Audio Analysis & Monitoring Toolset

A brand new RGB Vector Display instrument provides a tool to monitor gamut violations in production environments. Picture view, waveform monitor, vectorscope, 32 channel audio metering, decoded audio channel status information, ANC status and payload, on screen display of OP47 and CEA-608 in 708 closed captions and Ancillary Time Code (ATC), Loudness monitoring, and advanced control and logging with human readable event logs are all provided as standard.

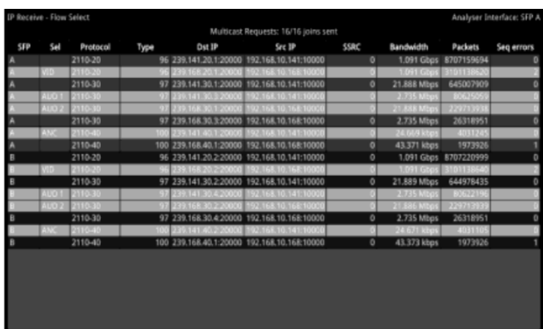

Advanced suite of IP Monitoring Tools

IP media interfaces are provided as standard in the LPX500. This 10G/25G/100G IP enabled waveform monitor supports JT-NM TR 1001-1:2018, 2110-20 (video), 2110-30 (PCM audio), 2110-31 (AES transport), and 2110-40 ANC media flows all with 2022-7 Seamless Protection Switching, and independent PTP followers on both media ports for fully-redundant media network operation.

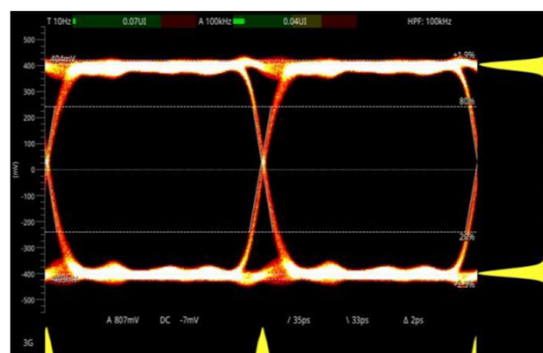

Fast, automated 12G-SDI Physical Layer Analysis

The Physical Layer Toolset is a factory-fitted option for fast 12G/6G/3G/HD/SD-SDI physical layer commissioning, testing and development. Its RTE™ (Real-Time Eye) Technology instantly highlights any SMPTE compliance issues and its realtime SDI jitter window provides simultaneous monitoring across five specified frequency bands. With its unique RTE™ (Real-Time Eye) multi-rate physical layer display, and automated SMPTE compliance measurements, the LPX500 offers a single product solution for SDI compliance verification.

An interface that puts you in control

Second, independent, touchscreen

A second, compact screen unit can now optionally extend the unit's local display capabilities, allowing you to control the unit from either physical screen. The second screen is also touch-enabled and supports the same gestures as the primary screen on the main unit. Connection to the second display is over a dedicated USB-C connector.

Further remote screen output combinations are also available to output either screen, from either the DisplayPort or SDI Mon BNC display outputs. In addition, dual built-in VNC clients considerably improve the performance of the remote connection to either display over noVNC.

Enhanced layouts and gestures

Following the innovative app style interface of PHABRIX instruments, the LPX500 hides the complexity of modern SDI and IP systems providing an uncluttered view of critical information. The enhanced layouts designed for the LPX500 not only extend the available screen real estate but now feature swipe gestures to navigate left or right through configured layouts and precise tap, hold and slide for instrument placement. Multiple screen layouts provide a huge canvas of extended screen real estate enabling you to move smoothly between instrument layouts, optimizing the viewing and touch experience on the unit.

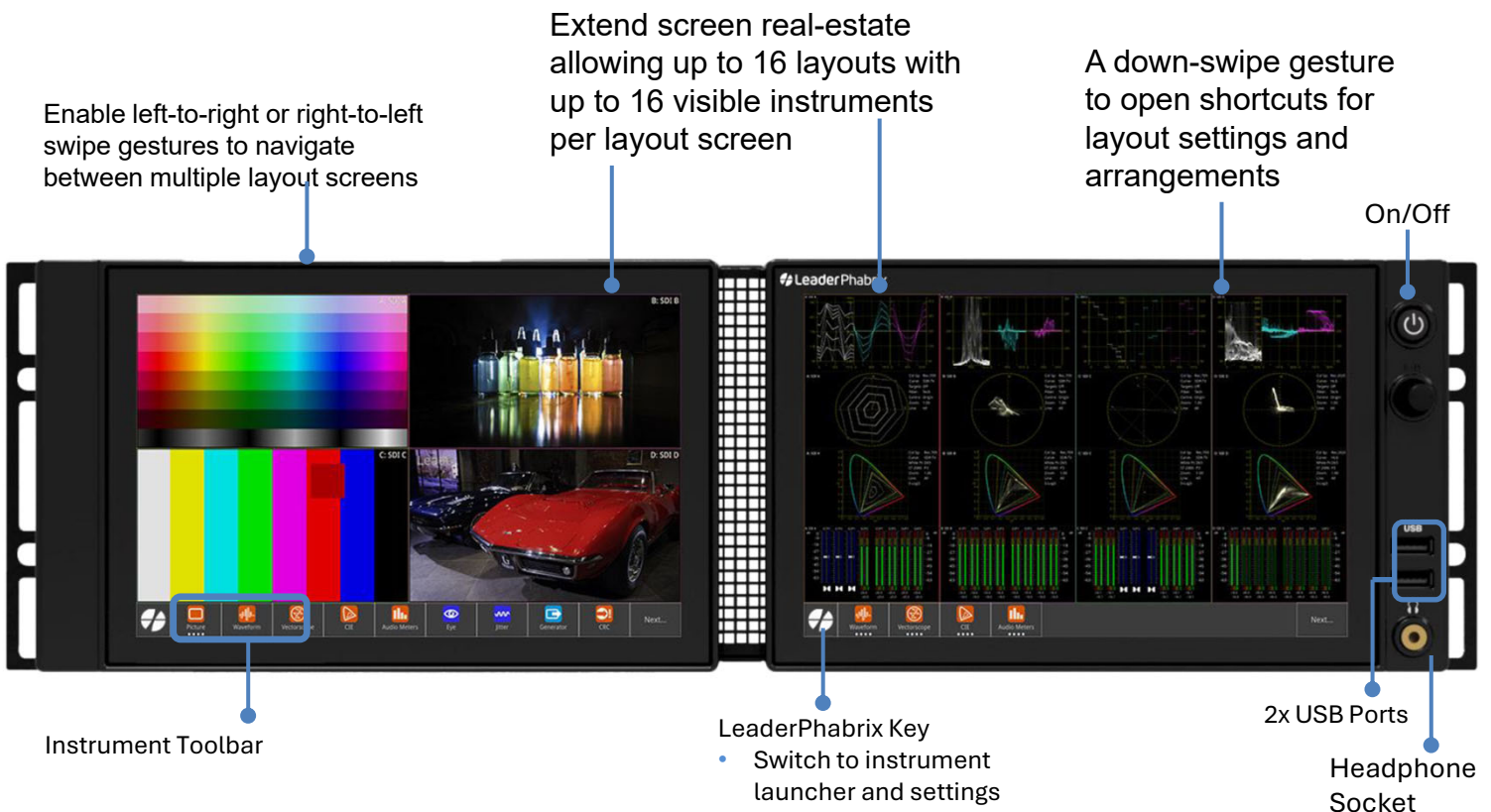

Single or Multi Display Layout Modes

Layout capabilities are further extended in the LPX500 by Single or Multi display modes and analyzer link features. Switching between display modes enables you to switch the Analyzers to which your instruments are connected.

- **Single Mode:** All configured layout screens use the same Analyzer channel but you can switch between analyzer channels through the display mode shortcuts, context menu dropdown, toolbar softkeys, etc.
- **Multi Mode:** Allows instruments in the layout to connect to multiple analyzers.

Remote Access

Various methods are provided to enable you to establish a remote connection with your LPX500, depending on your requirements.

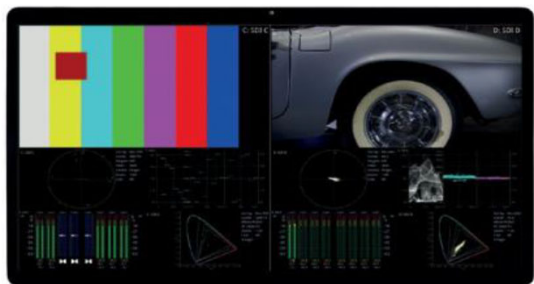

noVNC

- Browser remote access using noVNC technology to deliver up to 16 simultaneous scalable instruments per display over a remote network

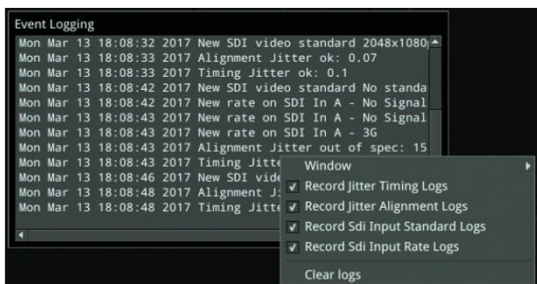

Event Logger

- SDI Input standard/status
- SDI physical layer timing and alignment jitter
- IP-Tx, IP-Rx, Flow and SFP records
- Reference Locking
- Audio input presence
- SCTE and REST AP request logs

LLDP Info		LLDP: Active	
	SFP1 Neighbour	SFP2 Neighbour	Mgmt Neighbour
Sys Name	qx-022228	qx-022228	SJP-T48U
Sys Descr	PHABRX LPX 1.0.0 210	PHABRX LPX 1.0.0 210	106.85.175.10
Chassis ID	00:1F:7F:00:56:D4	00:1F:7F:00:56:D4	192.168.0.181
Port ID	00:1F:7F:02:56:d4	00:1F:7F:01:56:d4	80:3e:01:58:88:3d
Port Descr	phabFth1	phabFth0	WAN PORT
Mgmt IP	192.168.0.103	192.168.0.103	
Primary VLAN	0	0	0

LLDP

- Identify port and device to which the LPX500 IP interfaces are connected
- Restrict information communicated over LLDP for IT security purposes
- Available in both ST 2110 and ST 2022-6

Qx Network & Automation	
Interface	Up
MAC Address	00:1F:7F:00:56:78
IP Addressing Mode	Dynamic
IP Address	192.168.0.104
Gateway	192.168.0.1
Default Gateway	192.168.0.1
DNS Server	192.168.0.10
mDNS Server	qx-022136.local
REST API	Listening on port 8080
VNC Server	No Connections

Mgmt Interface Config

- Manual or Dynamic Addressing modes
- mDNS and DNS
- Select Default Gateway from Media or Management interfaces



USB File Manager

- Copy presets, instrument logs, screenshots and user TIFF images to and from USB memory stick
- Delete selected files

Ordering LPX500

Product name	Description
LPX500 Model	
LPX500I	LPX500I - Dual input 10GE IP-only LPX500 analyzer
LPX500IS	LPX500IS - Dual input 3G-SDI only LPX500 analyzer
LPX500ISE	LPX500ISE - Dual input 3G-SDI only with single Eye & Jitter analyzer
Software Options (SDI/IP)	
LPX500-GEN	SW Option: SDI/IP AV Test Signal Generator (SDI req. LPX500IS or LPX500ISE)
LPX500-UHD	SW Option: 2K Extended + UHD/4K IP/SDI (SDI req. LPX500IS or LPX500ISE; in IP req. LPX500-IP-25G)
LPX500-HDR	SW Option: HDR/WCG, CIE1931, HDR Heat map (PQ, HLG, S-Log3, SR Live)
LPX500-QUAD	SW Option: For simultaneous Quad input analysis (enabling 2 further LPX500 inputs for Quad input analysis)
Software Options (IP Options)	
LPX500-IP-25G	SW Option: 25GbE media network (req. 2x PHSFP-25G-SR or PHSFP-25G-LR)
LPX500-IP-EUHD	SW Option: Add RGB, 12b, 444, 48-60Hz UHD formats to ST2110 (req. LPX500-UHD)
LPX500-IP-100G	SW Option: 100GbE media network (req. 2x PHSFP-100G-SR or PHSFP-100G-LR)
LPX500-IP-MEAS	SW Option: IP Measurement 2110-21, PIT histograms, timing
LPX500-IP-PCAP	SW Option: PCAP 2x25Gbps line rate capture tool, 4GB max
Additional Options	
LPX500-EM	HW Option: Extended Monitor - addition of second instrument display screen (left side of LPX500 unit)
LPX500-K3	HW Option: Desktop kit for LPX500 range (Handle and Feet)
LPX500-K1	3U 19" rackmount kit (1 x LPX500 chassis)
LPX500-K2	3U 19" rackmount kit (2 x LPX500 chassis)
SFP Accessoris	
PHSFP-10GE-SR	SFP+ 10GBASE-SR Ethernet MM 850nm 300m
PHSFP-10GE-LR	SFP+ 10GBASE-LR Ethernet SM 1310nm 10km
PHSFP-25GE-SR	SFP28 25GBASE-SR Ethernet MM 850nm 100m
PHSFP-25GE-LR	SFP28 25GBASE-LR Ethernet SM 1310nm 10km
Extend Warranty	
LPX500I-3YEAR	LPX500I Upgrade from 1 to 3 Year Warranty (excludes SFP)
LPX500I-5YEAR	LPX500I Upgrade from 1 to 5 Year Warranty (excludes SFP)
LPX500IS-3YEAR	LPX500IS Upgrade from 1 to 3 Year Warranty (excludes SFP)
LPX500I-5YEAR	LPX500IS Upgrade from 1 to 5 Year Warranty (excludes SFP)
LPX500I-3YEAR	LPX500ISE Upgrade from 1 to 3 Year Warranty (excludes SFP)
LPX500I-5YEAR	LPX500ISE Upgrade from 1 to 5 Year Warranty (excludes SFP)

PHABRIX Qx Series

We launched the Qx, an industry-leading rasterizer for 4K/UHD, HDR/WCG and SDI/IP test and measurement workflows, offering our loyal 3G-SDI customers an important stepping stone into the wide plethora of standards available today. The rapid development of the Qx Series over the past few years now sees it offer advanced toolsets for hybrid IP/SDI support using 4K/UHD (12G/6G/3G-SDI) and HD-SDI plus SMPTE 2022-6 and 2110 plus 2022-7 analysis and monitoring, along with comprehensive HDR/WCG analysis and 12G-SDI physical layer analysis toolset. All three product ranges are in continued development cycles and going from strength to strength. All three product ranges can be found in almost every major broadcaster and video manufacturing and product development team worldwide.

QxP

PHABRIX 2K/4K/IP INPUT WAVEFORM MONITOR



Display Size : 7 inches
Dimensions (WHD mm) :
211x132x305
Weight : 4.1kg (Excl. Battery)



QxL

PHABRIX 2K/4K/IP INPUT RASTERIZER



Dimensions (WHD mm) : 253 x 44 x 211
(1/2U Rack size)
Power supply : DC10V~DC18V



Qx

PHABRIX 2K/4K/IP INPUT RASTERIZER



EYE Pattern
Display Size : 7 inches
Dimensions (WHD mm) : 253 x 44 x 211
(1/2U Rack size)
Power supply : DC10V~DC18V



Formats supported

- IP SMPTE 2110/2022-7 over 10G IP
- IP SMPTE 2022-6 over 10G IP
- IP SMPTE 2110/2022-7/2022-6 over 25G IP (QxL & QxP)
- 3G/1.5G-SDI
- 12G/6G/3G/1.5G-SDI UHD
- UHD over 25G IP (QxL & QxP)

ST2110 analysis

- ST 2110 analysis and debugging tools to support engineers
- Simultaneously measures the packet timing interval of up to four IPs
- Measures ST2110-21 network compatibility model (Cinst) and virtual receiver buffer model (VRX)
- Timing measurement of video, audio, ANC, and PTP

ST2110 and ST2022-6 monitoring

- Monitoring of redundancy, video, audio, and ancillary data
- SIPS and PTP status report
- ST2110-30 Class C (80 channel max. at 125 us)
- NMOS ready

SDI stress tool

- Unmatched ability to test the performance of equipment or designs, with the ability to customize test signals with
- Control of jitter insertion frequency and amplitude
 - SDI scrambler and sync bit Insertion on/off
 - SDI Bit Error (BER) insertion tool
 - Control of SDI driver amplitude +/-15%
 - Control of pre-emphasis, rise/fall time
 - Generation of PRBS-7, 9, 15, 23, 31
 - Reported cumulative errors
 - Pathological signal detector

●QxP,QxL REAR PANEL

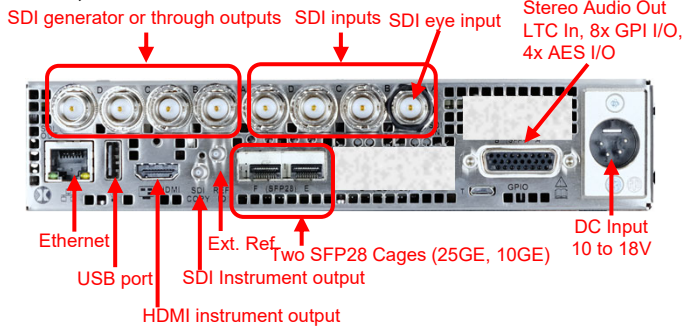

●Qx REAR PANEL

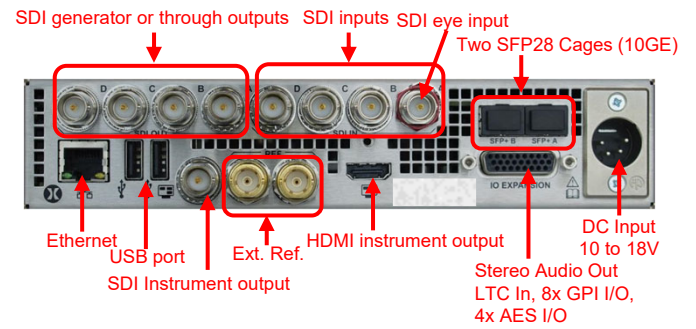

Base Units

Unit	Model #	Description
QxP Chassis V Mount	PHQXP-V	QxP 3U HD/2K 10G IP Waveform Monitor
	PHQXP01-3G-V	QxP 3U HD/2K 10G IP/SDI Waveform Monitor
	PHQXP01E-3G-V	QxP 3U HD/2K 10G IP/SDI Waveform Monitor with Eye & Jitter
QxP Chassis G Mount (QR Gold Mount)	PHQXP-G	QxP 3U HD/2K 10G IP Waveform Monitor
	PHQXP01-3G-G	QxP 3U HD/2K 10G IP/SDI Waveform Monitor
	PHQXP01E-3G-G	QxP 3U HD/2K 10G IP/SDI Waveform Monitor with Eye & Jitter
QxL Chassis	PHQXL	QxL 1U 1/2 rack HD/2K 10G IP Rasterizer
	PHQXL01-3G	QxL 1U 1/2 rack HD/2K 10G IP/SDI Rasterizer
	PHQXL01E-3G	QxL 1U 1/2 rack HD/2K 10G IP/SDI Rasterizer with Eye & Jitter
Qx Chassis	PHQX01-3G	Qx 1U 1/2 rack HD/2K SDI Rasterizer
	PHQX01E-3G	Qx 1U 1/2 rack HD/2K SDI Rasterizer with Eye & Jitter

Options / Accessories / Warranty

QxP	QxL	Qx	Description
Model #			Description
Subject: Hardware Option			
PHQXPM-01	PHQXLM-01		SDI I/O return to factory upgrade (requires PHQXP or PHQXL for each model)
PHQXPM-01E	PHQXLM-01E	PHQXM-01E	SDI I/O Eye/Jitter, return to factory upgrade (requires PHQXP01-3G or PHQXL01-3G or PHQX01-3G)
Subject : SDI Option			
		PHQXO-UHD	SDI 2K Extended + UHD/4K, 4xHD/6G/4x3G/2x6G/12G-SDI
PHQXPO-SDI-STRESS	PHQXLO-SDI-STRESS	PHQXO-SDI-STRESS	SDI Stress Test Tool Set (requires PHQX01E3G, PHQXO-UHD, PHQXO-GEN)
PHSFP-RT12-1310	PHSFP-RT12-1310	PHSFP-RT12-1310	SFP+ optical SDI Transceiver 12G/6G/3G/HD-SDI Single mode LC (10km), Non-MSA, Tx 1310nm, Rx 1260-1620nm
Subject : SDI/IP Software Option			
PHQXPO-DOLBY	PHQXLO-DOLBY	PHQXO-DOLBY	Dolby E Decode, Analyzer
PHQXPO-GEN	PHQXLO-GEN	PHQXO-GEN	SDI/IP AV Test Signal Generator (SDI, ST 2022-6, ST 2110) QxP:SDI requires PHQXP01-3G or PHQXP01E-3G. QxL:SDI requires PHQXL01-3G or PHQXL01E-3G, Qx : 2022-6 requires PHQXO-IP-STND)
PHQXPO-UHD	PHQXLO-UHD		2K Extended + UHD/4K IP/SDI, (SDI requires PHQXP01-3G/PHQXP01E-3G or PHQXL01-3G/PHQXL01E-3G)
PHQXPO-EUHD	PHQXLO-EUHD		Extended UHD: add RGB, 12b, 444, 48-60Hz formats to ST2110 IP, requires PHQXPO-UHD or PHQXLO-UHD
PHQXPO-HDR	PHQXLO-HDR	PHQXO-HDR	HDR/WCG, CIE 1931 Chart, HDR Heat map (PQ, HLG, S-Log3, SR Live)
Subject : IP Option			
		PHQXO-IP-STND	10G IP (ST 2022-6, ST 2110, PTP, NMOS IS-04/05)
PHQXPO-IP-25G	PHQXLO-IP-25G		25G IP (ST 2110) requires 2x PHSFP-25G-SR or 2x PHSFP-25G-LR)
PHQXPO-IP-MEAS	PHQXLO-IP-MEAS	PHQXO-IP-MEAS	IP Network Traffic Analysis : IP Measurement 2110-21, PIT histograms, timing
PHQXPO-IP-PCAP	PHQXLO-IP-PCAP	PHQXO-IP-PCAP	10G/25G Packet Capture Tool 4GB max.
PHQXPO-IP-NGT	PHQXLO-IP-NGT	PHQXO-IP-NGT	2022-6 IP Packet Interval Profile Generator requires PHQXPO-GEN
PHSFP-10GE-SR	PHSFP-10GE-SR	PHSFP-10GE-SR	SFP+ 10GBASE-SR Short Range Ethernet MM 850nm 300m Multi-mode Transceiver
PHSFP-10GE-LR	PHSFP-10GE-LR	PHSFP-10GE-LR	SFP+ 10GBASE-LR Long Range Ethernet SM 1310nm 10km Single-mode Transceiver
PHSFP-25GE-SR	PHSFP-25GE-SR		SFP28 25GBASE-SR Short Range Ethernet MM 850nm 100m Multi-mode Transceiver
PHSFP-25GE-LR	PHSFP-25GE-LR		SFP28 25GBASE-LR Long Range Ethernet SM 1310nm 10km Single-mode Transceiver
Subject : Test Cable			
PHQXC-1	PHQXC-1	PHQXC-1	12G-SDI Test Cable (BNC-BNC 1m)
Subject : Rack Mount			
PHQXK7			3U 19 inch rack mount kit (1x QxP Chassis)
PHQXK8			3U 19inch rack mount kit (2x QxP Chassis)
	PHQXK1	PHQXK1	19 inch rack mount kit (1x Qx/QxL Chassis)
	PHQXK2	PHQXK2	19 inch rack mount kit (2x Qx/QxL Chassis)
	PHQXK3	PHQXK3	9.5 inch rack mount kit (1x Qx/QxL chassis)
PHQXK9			QxP Desktop kit (adjustable feet plus handle)
Subject : Extended Warranty			
PHQXP-3YEAR	PHQXL-3YEAR		PHQXP Upgrade from 1 (standard) to 3 Year Warranty (excludes SFP)
PHQXP-5YEAR	PHQXL-5YEAR		PHQXP Upgrade from 1 (standard) to 5 Year Warranty (excludes SFP)
PHQXP01-3YEAR	PHQXL01-3YEAR	PHQX01-3YEAR	PHQXP01 Upgrade from 1 (standard)to 3 Year Warranty (excludes SFP)
PHQXP01-5YEAR	PHQXL01-5YEAR	PHQX01-5YEAR	PHQXP01 Upgrade from 1 (standard)to 5 Year Warranty (excludes SFP)
PHQXP01E-3YEAR	PHQXL01E-3YEAR	PHQX01E-3YEAR	PHQXP01E Upgrade from 1 (standard) to 3 Year Warranty (excludes SFP)
PHQXP01E-5YEAR	PHQXL01E-5YEAR	PHQX01E-5YEAR	PHQXP01E Upgrade from 1 (standard) to 5 Year Warranty (excludes SFP)

Technical Information

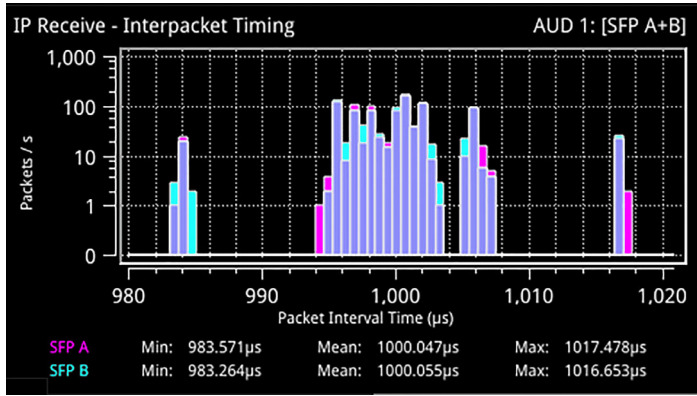

ST 2110 ANALYSIS FEATURE SET

Advanced Qx ST 2110 measurement tools include the provision of up to four simultaneous dual Packet Interval Timing measurement windows, detailed data reporting of flow packet, clock rates and PTP timing relationship, as well as IP Receive statistics that includes the measurements of the ST 2110-21 Network Compatibility model (Cinst) and Virtual Receiver Buffer Model (VRX).

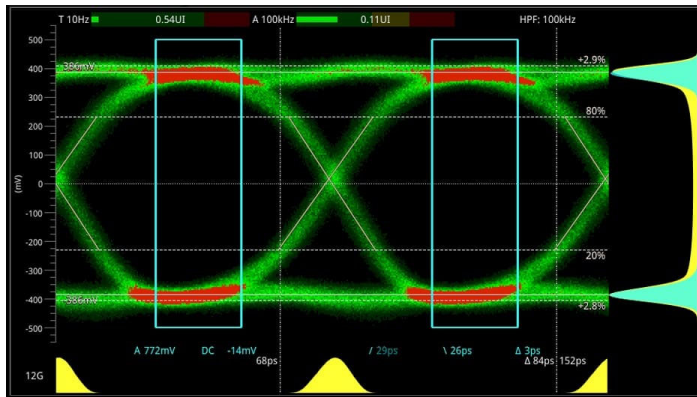

12G-SDI PHYSICAL LAYER & SDI-STRESS

The Qx offers a 12G/6G/3G/HD-SDI physical layer analysis option, including RTE™ (Real-Time Eye) technology to instantly highlight any SMPTE compliance issues including eye amplitude, transition times and overshoot. A suite of tools are available for users evaluating SDI interfaces.

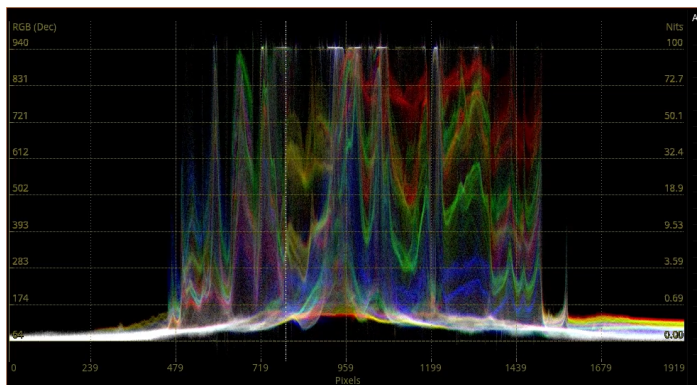

ADVANCED HDR ANALYSIS

The Qx's advanced HDR toolset includes a signal generator, CIE chart, Luma false color heat map/highlighting, waveform monitor and vectorscope. All the main live production SDR/HDR formats are supported: SDR BT.709, BT.2020, plus HDR BT.2100 HLG, PQ and Sony S-Log3 and SR Live. An extensive set of test patterns include BT.2111 HDR color bars for HLG, PQ and SR Live as well as SDR 709 patterns.

IP Receive - Flow Select
Multicast Requests: 16/16 joins sent

SFP	Sel	Protocol	Type	Dst IP	Src IP	SSRC	Bandwidth	Packets	Seq errors
A	VID	2110-20	96	239.141.20.1:20000	192.168.10.141:10000	0	1.091 Gbps	8707159694	0
A	VID	2110-30	97	239.141.30.1:20000	192.168.10.141:10000	0	21.888 Mbps	645007909	0
A	AUD 1	2110-30	97	239.141.30.3:20000	192.168.10.141:10000	0	2.735 Mbps	80625059	0
A	AUD 2	2110-30	97	239.168.30.1:20000	192.168.10.168:10000	0	21.888 Mbps	229713938	0
A	ANC	2110-40	100	239.141.40.1:20000	192.168.10.141:10000	0	24.669 kbps	4031245	0
A	2110-40	100	239.168.40.1:20000	192.168.10.168:10000	0	43.371 kbps	1973926	1	
B	2110-20	96	239.141.20.2:20000	192.168.10.141:10000	0	1.091 Gbps	870722999	0	
B	VID	2110-20	96	239.168.20.2:20000	192.168.10.168:10000	0	1.091 Gbps	3101138640	2
B	2110-30	97	239.141.30.2:20000	192.168.10.141:10000	0	21.889 Mbps	644978435	0	
B	AUD 1	2110-30	97	239.141.30.4:20000	192.168.10.141:10000	0	2.735 Mbps	80622196	0
B	AUD 2	2110-30	97	239.168.30.2:20000	192.168.10.168:10000	0	21.895 Mbps	229713938	0
B	2110-40	97	239.168.40.2:20000	192.168.10.168:10000	0	2.735 Mbps	26318951	0	
B	ANC	2110-40	100	239.141.40.2:20000	192.168.10.141:10000	0	24.671 kbps	4031105	0
B	2110-40	100	239.168.40.1:20000	192.168.10.168:10000	0	43.373 kbps	1973926	1	

SUITE OF IP MONITORING TOOLS

The Qx's ST 2110 core IP toolset provides an operator with 2110 confidence status monitoring in an intuitive and accessible manner. The toolset supports simultaneous decap of 1 video, 2 audio and 1 ANC Data flow supported SMPTE protocols include ST 2059 (PTP), ST 2110-20, -30, -31 and -40. ST 2022-7 seamless protection (SIPS) is provided for all four flows over two media network interfaces using industry standard SFPs.

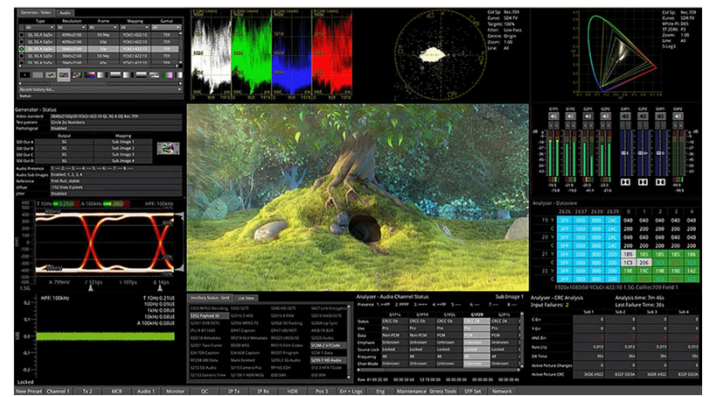

USER-DEFINED INSTRUMENT LAYOUT

Out of the box, the Qx offers media analysis for broadcast operator environments, with a flexible user-defined instrument layout displaying up to 16 simultaneous windows, and the ability to rapidly change between bespoke layouts for different operational tasks with user presets.

AUDIO AND VIDEO GENERATION

Type	Resolution	Frame	Mapping	Gamut
All	All	All	All	All
12G 2-SI	4096x2160	59.94p	YCbCr:422:10	HLG 2020
12G 2-SI	4096x2160	60p	YCbCr:422:10	HLG 2020
12G 2-SI	3840x2160	50p	YCbCr:422:10	HLG 2020
12G 2-SI	3840x2160	59.94p	YCbCr:422:10	HLG 2020
12G 2-SI	3840x2160	60p	YCbCr:422:10	HLG 2020

Recent history list...
Status: Creating video standard

AUDIO AND VIDEO GENERATION

Generate and analyze a set of SDI/IP formats. Moving test patterns offer up to 32 channels of embedded audio per link or subfield (up to 128 channels on 12G interfaces). The toolset provides core full screen SDI Pathological SDI stress patterns as well as allowing the user to define a combination of SDI stress and conventional generator patterns up to full frame.

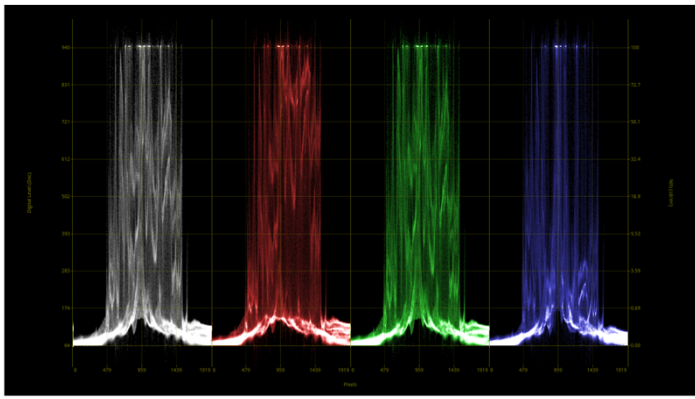

HD-SDI ANALYSIS AND MONITORING

Picture view, waveform, vectorscope, 32 channel audio metering, detection of Dolby formats, ANC status and payload, on screen display of OP47 and CEA-608 in 708 closed captions and Ancillary Time Code (ATC), and advanced control and logging are all provided as standard.

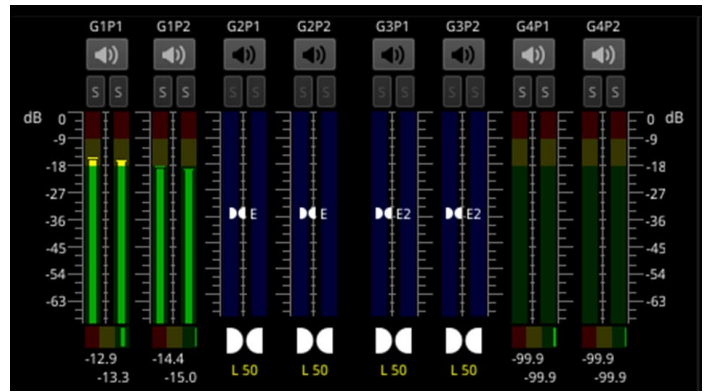

DOLBY® E DECODER & METADATA ANALYZER

The Dolby E Decoder and Metadata Analyzer option provides a clear and accessible view of the Dolby E metadata present in a selected Dolby E or ED2 audio stream. It also enables you to check the correct timing of Dolby E packets in the audio signal in an SDI or ST 2022-6 broadcast chain. You can check whether the Dolby E is created correctly and transferred transparently by network equipment such as routers, switchers, satellite links, etc.

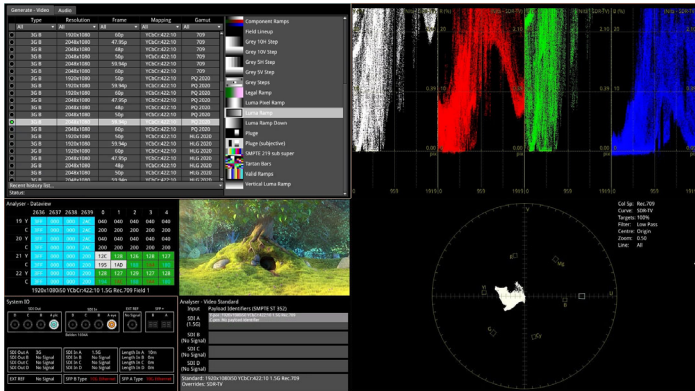

PRESETS, VNC and GUI SCREENSHOTS

The Qx interface employs VNC technology to deliver 16 simultaneous instrument windows over a remote network. Multiple display layouts can be saved as presets. This allows users to save bespoke layouts for different operational tasks; useful for rapidly changing between different screen layouts eg. Audio, HDR or IP focus.



3U instrument with integral 1920 x 1200, 7 inch LCD touch screen

The QxP's integrated 7 Inch multi-touch LCD display adds a new control layer to the Qx Series. Building on the Qx Series' innovative app based GUI, users are now able to configure and monitor all of their required instrumentation from the front display, up to 16 Instruments can be configured in various sizes. Plug in an external HDMI monitor and you have the same experience as if you were using the QxP as a conventional Rasterizer.

NMOS Senders - SDP - Active		NMOS Enabled: 192.168.10.254:8010							
		VID	AUD 1	AUD 2	AUD 3	AUD 4	ANC	VIDMON	AUDMON
SFP E	Master Enable	✓	✓	✓	✓	✓	✓	⊖	⊖
	RTP Enabled	✓	✓	✓	✓	✓	✓	⊖	⊖
	SDP Present	✓	✓	✓	✓	✓	✓	✓	✓
SFP F	Master Enable	✓	✓	✓	✓	✓	✓	⊖	⊖
	RTP Enabled	✓	✓	✓	✓	✓	✓	⊖	⊖
	SDP Present	✓	✓	✓	✓	✓	✓	✓	✓

AMWA NMOS TOOLSET

A suite of AMWA NMOS tools that provide flexibility when integrating with an NMOS controller and associate network Topology. Supported protocols: IS-04 v1.0, 1.1, 1.2, 1.3 IS-05 1.02, 1.1 and IS-09 PTP domain. Provision of both in-band and out-of-band control topologies with manual, mDNS, DNS-SD and DHCP. Senders and Receivers can be independently configured as single or dual NMOS end points.(QxL,QxP)



V-mount/G-mount Battery Plate for external battery and portable operation

The QxP is the world's first portable, 12G-SDI, 25G-ST 2110, combined waveform monitor, generator and analyzer, with support for mains, external DC power and comes with a V-mount or G-mount battery plate as standard, allowing for the unit to be powered by an external camera battery. This makes the QxP ideally suited for On-Set Production, Outside Broadcast, Commissioning, Engineering and R&D environments

PHABRIX Sx Series

Just like a Swiss army knife, a product conceived as a simple mix of technologies developed into three test instruments in one; an SDI signal generator, analyzer and monitor with an amazing array of tools. The Sx rapidly developed as a handheld video and audio testing device capable of supporting 3G-SDI, HD-SDI, SD-SDI video plus AES – a world's first for such a product. As engineers at PHABRIX, we designed the kind of product we'd like to use ourselves.

PHABRIX SxTAG

SDI/IP Portable Analyzer and Generator

IP IP-TSG 3GSDI HDSDI SDSDI

Weight/Size: 900g, H:92mm, W:225mm, D:42mm

Integral battery supply : 1-2 hours lithium polymer

- Supports SFP optical HD-SDI input/output
- Supports IP ST 2022-6 and ST 2110
- Supports composite input/output (BB, tri-level)
- 3G-SDI, HD-SDI, SD-SDI video signal generator
- Supports balanced analog and digital audio input/output
- Equipped with picture monitor, waveform monitor, vectorscope, audio monitor, and signal data analysis functions



SFP is optional.



PHABRIX SxE

SDI/Eye Portable Analyzer and Generator

3GSDI HDSDI SDSDI

Weight/Size: 900g, H:92mm, W:225mm, D:42mm

Integral battery supply : 1-2 hours lithium polymer

- Eye pattern and jitter analyzer for 3G-SDI, HD-SDI, and SD-SDI signals
- 3G-SDI, HD-SDI, and SD-SDI video signal generator
- Equipped with picture monitor, waveform monitor, vectorscope, audio monitor, and signal data analysis functions
- Audio monitoring is possible using the AES/EBU digital audio signal generator, level monitor, and speaker.



PHABRIX SxD

SDI/Dual Link Portable Analyzer and Generator

3GSDI HDSDI SDSDI

Weight/Size: 900g, H:92mm, W:225mm, D:42mm

Integral battery supply : 1-2 hours lithium polymer

- 3G-SDI, HD-SDI, SD-SDI, Dual Link (SMPTE372M), and 3G-A/3G-B (SMPTE425M) video signal generator and analyzer
- Equipped with picture monitor, waveform monitor, vectorscope, audio monitor, and signal data analysis functions

* The SxD has two SDI input and SDI output connectors.

* The SxD does not have AES input or output connectors.



PHABRIX SxA

SDI Portable Analyzer and Generator

3GSDI HDSDI SDSDI

Weight/Size: 900g, H:92mm, W:225mm, D:42mm

Integral battery supply : 1-2 hours lithium polymer

- 3G-SDI, HD-SDI, and SD-SDI video signal generator and analyzer
- Equipped with picture monitor, waveform monitor, vectorscope, audio monitor, and signal data analysis functions
- Audio monitoring is possible using the AES/EBU digital audio signal generator, level monitor, and speaker.



Technical Information

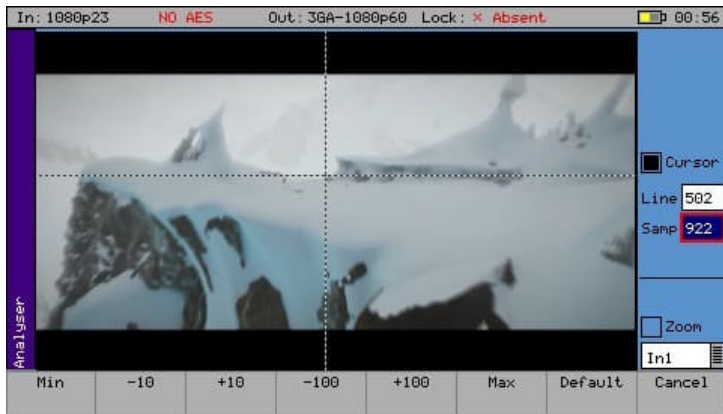

Picture Monitor

- The picture is displayed in a window as a down-converted display.
- A cursor may be turned ON over the area of the picture specified by the specified line and sample.
- Monitor device input or output.

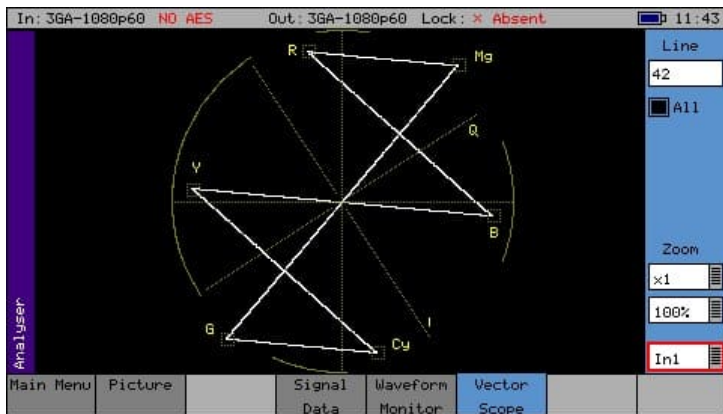

Vectorscope

- Choice of 100% or 75% graticules .
- Display the Composite(Sx TAG Only), SDI, SFP(Sx TAG Only) video input or the generator test pattern.
- Display a specific video line linked to picture cursor
- x1, x2, x5 or x10 magnifications with position to center , cyan, yellow, green, magenta, red, blue graticule locations

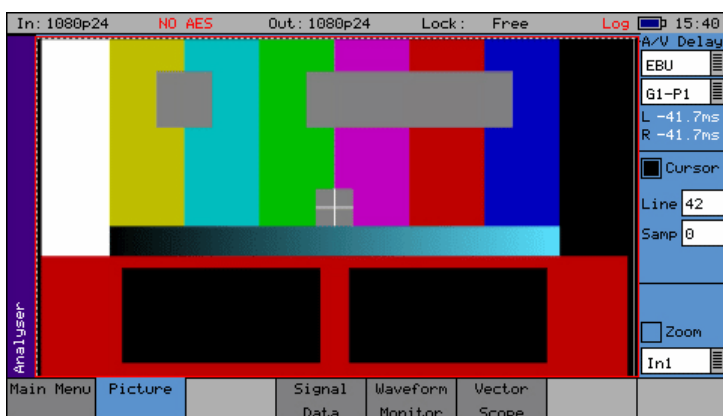

AV Delay Analysis

- Optional Software License.
- Support for adapted EBU Tech 3305 AV Sync and operation test pattern.
- Support for LAWO V_line AV Sync test pattern.
- Real time update of measured AV delay.
- +/- 400ms operating range.
- Select audio from SDI or AES input.

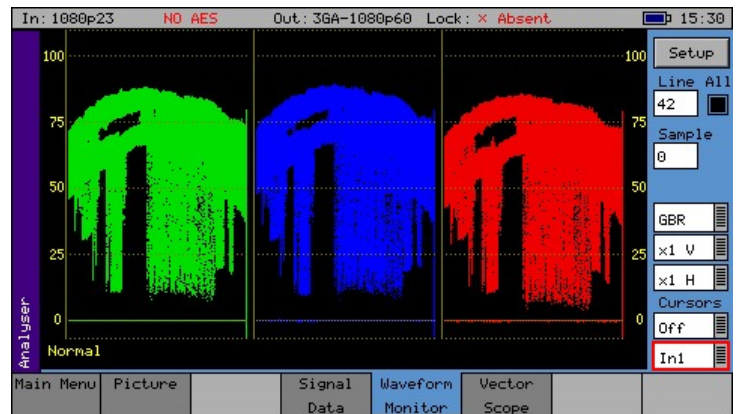

Waveform Full Frame

- Displays selected analyzer or generator source.
- Analog locking reference input view. (TAG only)
- YCbCr GBR, Y, Cb, Cr, R, G, B modes.
- Cursors may be displayed over the waveform to allow measurement of time or amplitude values.
- Vertical and horizontal magnifications.

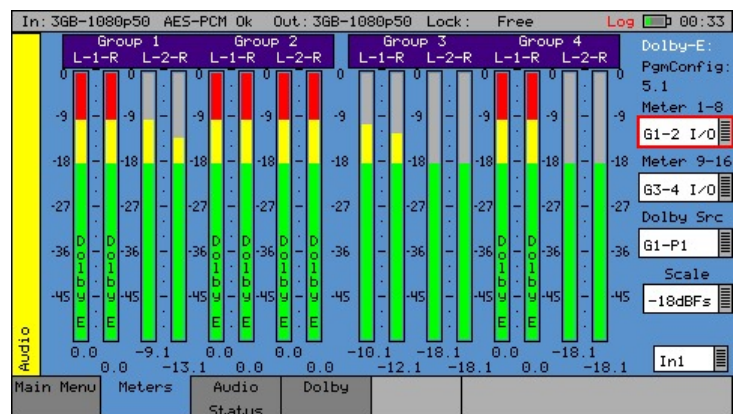

Dolby Metering

- Optional Software License.
- The detected Dolby Audio type is displayed in the audio meters.
- Dolby Audio is not decoded Dolby E metering is provided.

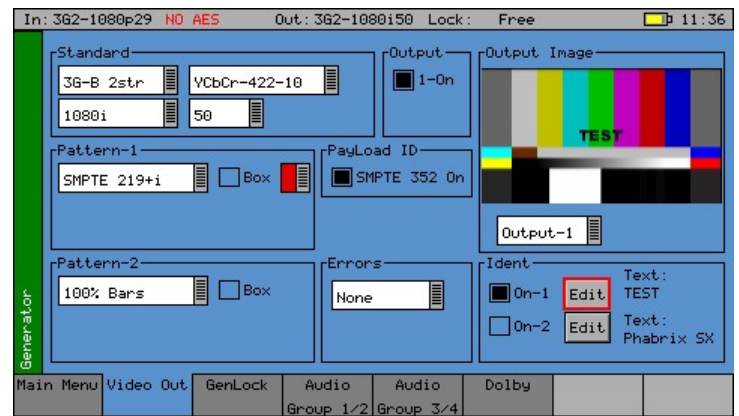

Video Generator

- The Sx can create video test signals for all supported SD and HD SDI output standards including the 3GHz standards at 1080p/50/59/60 Y, Cb, Cr.
- Advanced video formats include support for RGB, XYZ 12bit and 2K formats.
- A fully programmable Y Zone Plate

Base Unit

Model #	Description	Product Details
PHSXTAGC	Sx TAG Analyzer/Generator	3G/HD/SD-SDI, composite, analog and digital audio support
PHSXTAGC-IP	Sx TAG-IP Analyzer/Generator	Sx TAG + Optional PHSXO-IP + Accessories PHSFP-10SR-IP
PHSXE	SxE Analyzer/Generator	3G/HD/SD-SDI, EYE pattern, digital audio support
PHSXD	SxD Analyzer/Generator	3G/HD/SD-SDI, dual link, digital audio support
PHSXA	SxA Analyzer/Generator	3G/HD/SD-SDI, digital audio support

Options/Accessories/Warranty

SxTAG	SxE	SxD	SxA	Model #	Description	Product Details
Option List						
✓				PHSXO-3GADV	3G+2K format support	3G-SDI, 422/444, YUV/RGB, 10/12 bit, SMPTE 428-9 D-Cinema/SMPTE ST 2048-2:2011 compatible.
✓	✓	✓	✓	PHSXOS	Command Scripts + Reports	Create and save commands and generate reports for repeated tests.
✓	✓	✓	✓	PHSXOSD	SDI data display + ANC check	Displays a data dump of SDI.
✓	✓	✓	✓	PHSXOR	Enhanced Remote Control	Remote control of the main unit from an external PC via TCP/IP.
✓	✓	✓	✓	PHSXOZ	Programmable zone plate	Allows control of zone plate pattern parameters.
✓	✓	✓	✓	PHSX-DAG	Dolby E/D/D+ Analyze+ Generator	Dolby streaming, metering, timing measurements
✓				PHSXO-ENGT	engineering package	This package includes PHSXO-3GADV, PHSXOS, PHSXOSD, PHSXOR, PHSXOZ, and PHSXO-DAG.
	✓	✓	✓	PHSXO-ENG	engineering package	This package includes PHSXOS, PHSXOSD, PHSXOR, PHSXOZ, and PHSXO-DAG.
✓	✓	✓	✓	PHSXO-AVD	AV Delay Generator/Measurement	AV delay (lip-sync) pattern signal generation and its measurement for SDI and IP.
	✓			PHSXOEA	Extended eye pattern, jitter	Added eye pattern and jitter analysis functions
✓				PHSXO-IP	IP Encap / Decap License	Upgrade your purchased SxTAG to SxTAG-IP, compatible with ST2022-6, ST2110, NMOS IS04/05/08 *PHSFP-10SR-IP is Required.
Accessory						
✓				PHSFP-10SR-IP	10GBASE-SR SFP	ST2110,2022-6,NMOS-compatible SFP
✓				PHSFP-RT30-HDBNC	SFP 3G/HD/SD Transceivers	Both input and output via BNC are possible.
✓				PHSXC-1	audio cable	Analog Audio D15 to XLR Connector Conversion Input Cable
Extended Warranty						
✓	✓	✓	✓	PHSX-3YEAR	3-year warranty	Upgrade the standard warranty period to a total of 3 years. (excluding SFP modules)
✓	✓	✓	✓	PHSX-5YEAR	5-year warranty	Upgrade the standard warranty period to a total of 5 years. (excluding SFP modules)

Sx Series Side Terminal

●TAG Left Side

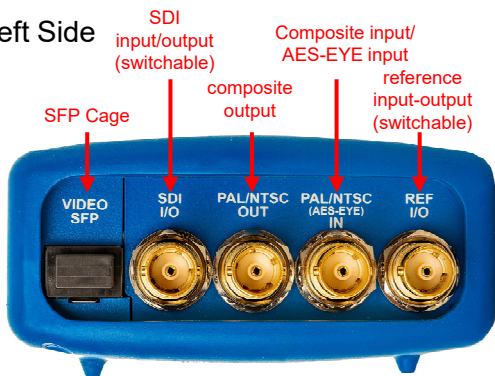

●TAG Right side

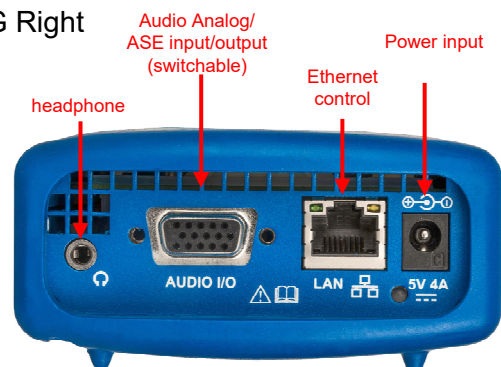

●SxE Left side

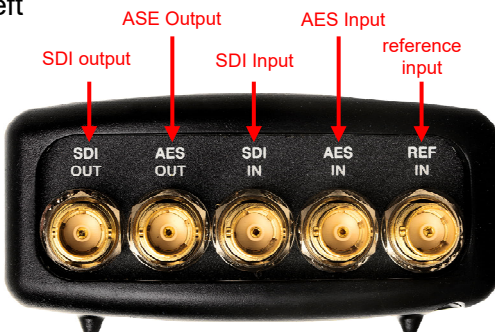

●SxE / SxD / SxA common right side

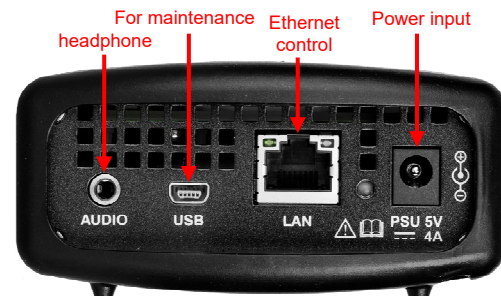

●SxD Left side

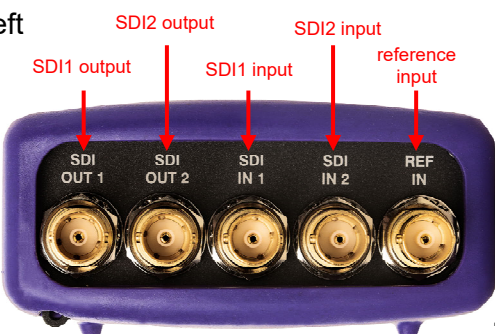

●SxA Left side

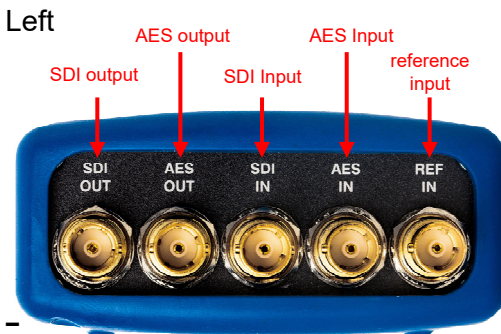

PHABRIX Rx Series

The Rx series delivers advanced 3G/HD/SD signal generation, analysis, and monitoring for closed captions and loudness compliance testing and for video and audio problem solving. Waveform, vector, picture, audio and eye pattern monitoring from any location.

PHABRIX Rx2000

- 4 channel SDI signal analyzer/generator 3G/HD/SD)
- Monitoring via dual built-in screens and audio speakers
- Full high definition HDMI and SDI rasterizer outputs



PHABRIX Rx1000

- 4 channel SDI signal analyzer/generator 3G/HD/SD)
- Full high definition HDMI and SDI rasterizer outputs



PHABRIX Rx500

- 2 channel SDI signal analyzer/generator 3G/HD/SD)
- Full high definition HDMI and SDI rasterizer outputs



Hardware Modules



PHRXMA Dual input 3G/HD/SD SDI single analyzer

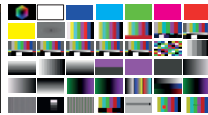
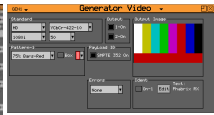

PHRXMAG Single input 3G/HD/SD SDI single analyzer plus SDI generator



PHRXMAE Dual input 3G/HD/SD SDI single analyzer with eye and jitter



PHRXMAGE Single input 3G/HD/SD SDI single analyzer with eye and jitter plus SDI generator

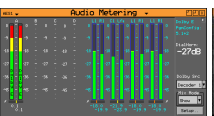

PHRXM4 AES Audio I/O 75 Ohm unbalanced



PHRXM-DOLBY Dual Dolby decoder Dolby E/D/Plus (mounted on CPU card)



PHRXMANA Analog audio line level output convertor

Specifications

Description	Rx 500	Rx 1000	Rx 2000
SD-SDI, HD-SDI as standard	✓	✓	✓
Optional 3G-SDI (license)	✓	✓	✓
Dual 16:9, 24 bit, 4.3" TFT, 480 x 272 pixels	N/A	N/A	✓
OLED display	✓	✓	N/A
Front panel USB 2.0 host port type A socket + 2 rear panel USB 2.0 ports	✓	✓	✓
Internal loudspeaker	Beeper	Beeper	2 x 7w wide range
I/O Module slots (each supporting a range of audio/video modules)	2	4	4
Internal Dual Dolby® decoder module slot (option)	1	1	1
HDMI instrument output, 1920 x 1080, 4:4:4 RGB, Type A	✓	✓	✓
SDI instrument output, 1920 x 1080, 4:2:2 YUV, BNC 75 Ohm	✓	✓	✓
Basic SDI generator included as standard (replaces instrument output)	✓	✓	✓
8 channel 48kHz PCM audio on HDMI and SDI Instrument outputs	✓	✓	✓
Reference/VITC input, passive loop through, BNC 75 Ohm compensated	✓	✓	✓
AES input AES 3-ID, SMPTE 276M-1995, 75 Ohm BNC	✓	✓	✓
LTC input (via 26 pin high density 'D' Type socket)	✓	✓	✓
Stereo analog audio output, (via 26 pin high density 'D' Type socket)	✓	✓	✓
Calibrated stereo balanced analog audio output (option module)	✓	✓	✓
Ethernet remote control via browser, RJ45 connector, 10/100Base-T	✓	✓	✓
IP sockets based remote control as standard	✓	✓	✓
Viewing angle tilt mechanism	N/A	N/A	✓
Desktop mounting kit	✓	✓	N/A
19" Rack-mount kit	1U (options)	1U (standard)	2U (standard)
10.5"/9.5" Rack-mount	✓	N/A	N/A
Whisper quiet temperature controlled fan	1x 40mm internal	2 x 40mm external	1 x 60mm external
Power consumption (variable on modules inserted)	24W typical 40W max	24W typical 70W max	27W typical 80W max
4 Pin XLR power connector, 12V nominal (9V-18V)	✓	✓	✓
AC Power adaptor (included), 90-264VAC, 120W	✓	✓	✓
Dimensions (width x height x depth) excluding ears & projections	210 x 44 x 170mm	440 x 44 x 170mm	440 x 88 x 150mm
Weight (chassis with CPU module and 1xAG option module fitted)	1.3 kg	2.0 kg	2.3 kg
1year manufacturers warranty - 3 & 5 year warranty options available			

ASACA VC4000 4K Multi Format Converter



VC4000 is a television format converter that, converts 4K, HDTV and SDTV formats with different frame rates and minimizes jerkiness even with fast moving images. Supports up conversion, down conversion and cross conversion.



IN \ OUT	2160p		1080i	
	59.94	50	59.94	50
2160p	59.94	Standard equipment	Option 1 VC4000SYS	
	50			
1080i	59.94	Option 2 VC4000SYS		Option 3 VC4000SYS
	50			
720p	59.94	Option 3 VC4000SYS		
	50			
625i	50	Option 4		

ASACA DUX-214 Audio Channel ID SDI Signal Generator



Audio channel ID on voice signal can be output. (channel one to channel sixteen on voice)

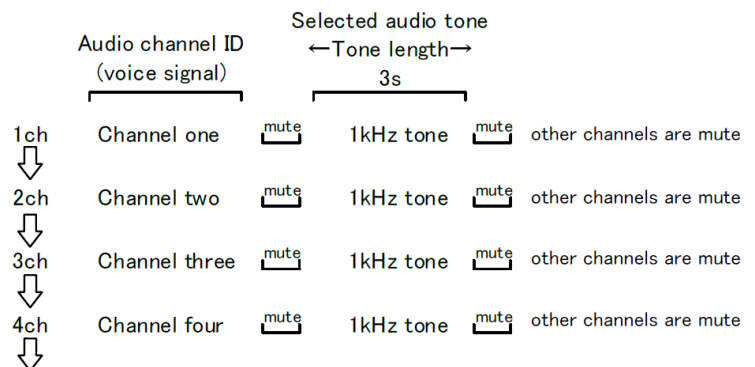

Leader

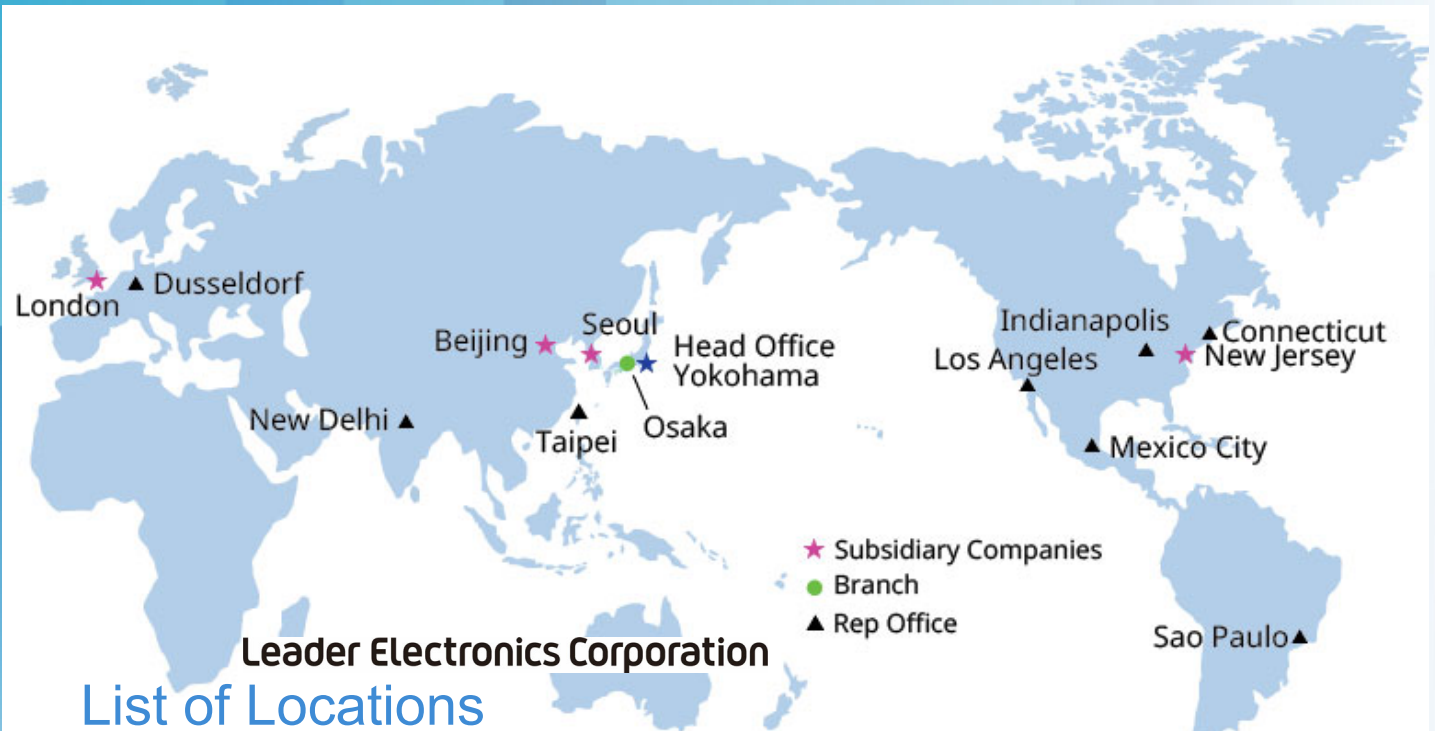

Leader Electronics of Europe

2-6-33 Tsunashima-higashi, Kohoku-ku, Yokohama 223-8505 Japan
Tel: +81-45-541-2123
URL : www.leader.co.jp/en Email: sales@leader.co.jp
Area: [Japan and Southeast Asia, Oceania](#)

Leader Instruments Corporation

2125 Center Avenue, Suite 406, Fort Lee, NJ 07024 USA
Tel: +1-201-355-4850
Email: info@leaderamerica.com
Area: [USA and Canada](#)

Leader Electronics of Europe limited (UK)

Omega House, Enterprise Way, Thatcham, RG194AE, United Kingdom
Tel: +44-20-3958-6289 Germany Tel: +49-174-3977799
Email: sales@leadereurope.com
Area: [Europe and Africa](#)
Tel: +91-98111-06956 Email: Umesh@leaderindia.in
Area: [India and Middle East](#)

JiaLong Leader (Beijing) Trading Co., Ltd.

Room 1103, 11F, Building 3, No.150 GuanZhuang Road, ChangYing Town, ChaoYang District, Beijing zip100024, P.R.China
Beijing Tel: +86-10-8511-8606 Email: beijing@leadercorp.com.cn
Area: [China](#)

Leader Korea Co., Ltd.

#R1110, 11F, Gangdong Green Tower Bldg., 1139, Cheonho-daero, Gangdong-gu, Seoul, 05355
Tel: +82-10-6245-7311
Email: jhlee@leaderkorea.kr
Area: [South Korea](#)

Leader Taiwan Representative Office

14F, No. 51, Sec. 2, Keelung Rd., Xinyi Dist., Taipei City, 112, Taiwan
Tel: +886-933-800-188 Email: Chen.p@leadertaiwan.tw
Area: [Taiwan, Hong Kong and Macau](#)

Latin America Branches

Area: [Mexico, Central America, Colombia, Ecuador and Venezuela](#)
Tel: +1-305-213-4827 Email: salvador delaserna@leaderamerica.com
Area: [Argentina, Bolivia, Brazil, Chile, Peru and Uruguay](#)
Tel: +55-11-2863-3822 Email: ishimaru@leaderamerica.com



Safety Precautions

In order to use the product correctly and safely, carefully read the instruction manual prior to first use.

Specified product specifications are subject to change without notice. Apr.2025

* This Short Form catalog has been simplified.
Please check additional product information on our website. URL : <https://leaderphabrix.com/>