

Rx Series

ADVANCED RASTERIZERS FOR 2K/3G/HD/SD
SIGNAL GENERATION, ANALYSIS & MONITORING



Leader

 **PHABRIX®**
A Leader Company

Rx Series Overview

Faster fault diagnosis, ultra-flexible monitoring

Based on the award-winning Sx portable test & measurement range, the rack-mounted Rx series of rasterizers delivers advanced 2K/3G/HD/SD signal generation, analysis and monitoring for faster compliance testing and fault diagnosis of both video and audio signals.

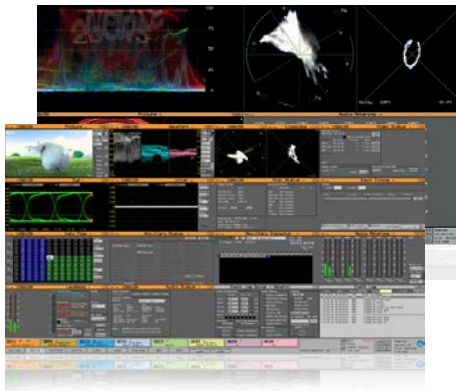

Up to 16 Simultaneous Instruments

Monitoring workflows are optimized with ultra-flexible, user-defined instrument display layouts. Up to 16 instruments can be presented simultaneously, at sizes ranging from full screen down to 1/16 screen. In multi-channel environments, channel identification is simplified with a dedicated window color per channel.

Monitoring configurations can be built to suit individual operators and key applications, with rapid recall of layout pre-sets for fast turnarounds. Up to 99 presets are available to suit even the largest facility.



Video Capture & Remote Access

To speed intermittent fault finding, the Rx Series offers video and audio capture to help diagnose problems. The capture can be triggered automatically when faults are identified by the analyzer, according to user-defined criteria.

Fault diagnosis is also quickened by the remote access capability, which allows engineers to monitor and analyze video via a web browser from any location.

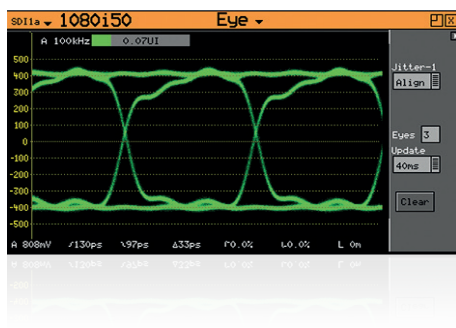

Four Channel Eye & Jitter Analysis

Advanced diagnostic tools include up to four simultaneous Real-Time Eye™ and Jitter physical layer analysis instruments plus closed caption, loudness and Dolby® monitoring. This makes the Rx Series ideal for OB trucks, broadcast facilities and video technology manufacturers.

Rx Rasterizers - 3x the choice

Available with built-in monitoring or ultra-compact design

Rx 2000

4 channel analyzer/generator with monitoring via dual built-in screens & audio speakers



Rx 1000

Compact 4 channel analyzer/generator and monitoring system



Rx 500

2 channel analyzer/generator & monitoring solution



User-defined Instrument Display Layout

Up to 16 instruments via HDMI/SDI display & remote browser

2 Channel QC Check - up to 4 channels simultaneously with 4 modules



Single Instrument

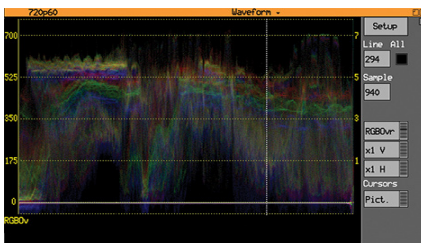

- Full screen mode available for picture display and waveform monitor enabling detailed analysis

Quad Screen

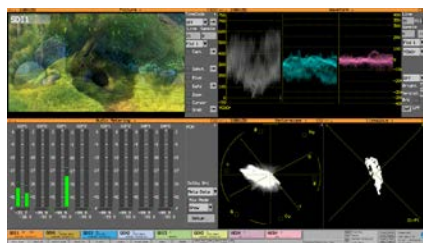

- Display four key instruments in quad screen for easy viewing

16 Instruments



- Display up to 16 instruments on a single 1920x1080 display



Four Channel Analysis



Up to 99 user configurable presets



Indicative video centric preset



Indicative audio centric preset

- Each instrument or screen has a size icon to instantly resize to quarter or sixteenth size. Picture display and waveform monitor are also available in full screen

- All the tools needed to monitor or debug a video source with one click
- Full flexibility on which channels are analyzed and choice, size and location of instruments

- Quickly access the tools you need to monitor and diagnose complex audio issues
- Powerful rasterizer provides simultaneous multiview of selected audio tools

Rx Series Toolsets



Video Toolset



Picture Display

- Scaling from 1/16, 1/4, 9/16, full screen
- Cursors linked to waveform and data view
- Action and title safe areas
- On screen configurable source ident
- Zoom, 4:3, 16:9

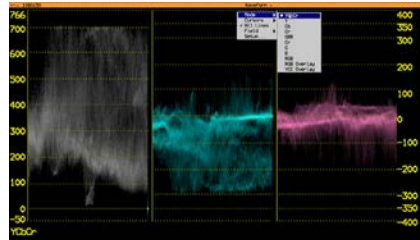

Waveform Monitor

- Configurable H and V graticules
- Overlay, Parade, Single line, H & V Mag, brightness, persistence and monochrome controls
- Time and amplitude measurement cursors
- Cursor linked to picture and data view
- A wide selection of YCbCr and GBR parade modes

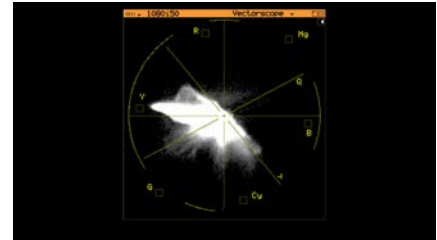

Vectorscope

- 12-bit processing
- x1 to x10 magnification
- 75% and 100% targets
- I, Q axis



Auxiliary Data - Decode

- ANC time code configurable display
- Closed captions: WST/OP42/OP47, CEA-608 (in 708), CEA-708
- AFD/WSS/VI
- VChip

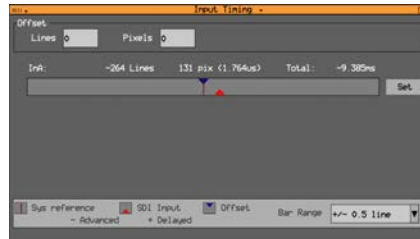

Input Timing

- Visual indication and measurement of video input timing with respect to reference
- Line and pixel offset controls to configure measurement



Multi-frame Grab

- Full stream capture and looped playback of single or multiple frames of video, embedded audio and ANC
- Export and import of grabbed files
- Manual or auto trigger controls
- Trigger on errors in ANC, CRC and EDH



AV Delay Generator

- Adapted EBU Tech 3305 AV sync and operational test pattern to support SD and HD formats
- Compatible with third party AV delay analyzers e.g.:LAWO V_pro8
- Individual selection of audio pair
- Up to 16 channel audio insertion

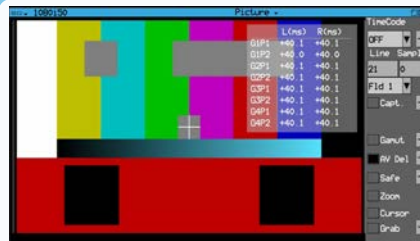

AV Delay Analysis

- Support for Adapted EBU Tech 3305 AV sync and operational test pattern
- Support for LAWO V_line AV Sync test pattern
- Realtime update of measured AV delay
- +/- 400ms operating range

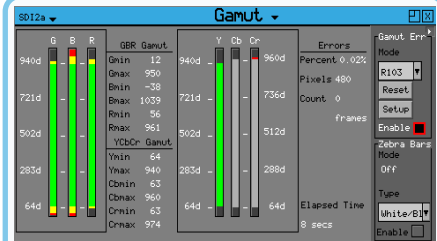

Gamut Meters

- Monitor gamut values of the source video
- Red, amber & green gamut metering bars for RGB and YCbCr color spaces; indicate minimum and maximum gamut values in the active picture
- Preconfigured configurations for R103 and Legal standard gamut monitoring
- One gamut monitor for each installed Analyzer module [A and AG modules only]



Audio Toolset

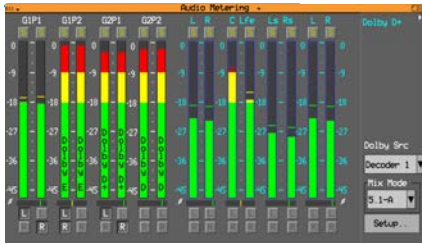

Audio Metering

- Metering of up to 16 embedded audio channels
- Metering Ballistics: PPM-I, PPM-II, Vu, Vu-Fr, Fast
- Scales: dBFS, BBC, BBCM, DIN, Nordic
- Adjustable peak hold times from 0.1s to Inf
- Audio pair phase meters
- Detection of Dolby DE, DD, DD+ and metering of decoded audio



Loudness Monitoring

- EBU R128 and ITU-R BT.1770
- Indicators for true peak, range, momentary, short term and integrated loudness
- User control of integrated, momentary and short term targets
- User adjustable true peak alarm threshold
- Loudness logging stored automatically
- GPI enable of Loudness Monitoring



Downmix Monitoring

- 5.1 Surround sound to 2.0 Stereo downmixing
- User control of routing and soloing of PCM channels onto the downmix bus
- Downmix bus is independently routable to speaker/headphone and rear panel/HDMI outputs
- LoRo Downmix available from Dolby DD, DD+ decoder outputs

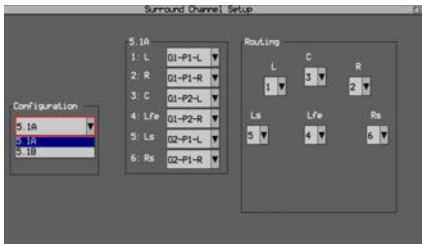

Surround Channel Set-up

- Two 5.1 configuration presets
- User control of channel order routing
- Control of the mapping of 5.1 surround channels to PCM group, pair and channels



Lissajous Display

- 2D display of phase relationship between the selected audio pair
- Selection of input PCM or decoded Dolby audio
- AGC or manual scaling

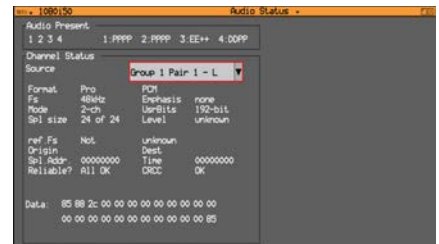

Audio Status

- 16 channel indication of audio type and presence with detection of Dolby DE, DD and DD+
- Decode of channel status information for each audio channel

Optional Toolset [PHRXO-BDG]



Dolby® Generator

- Generation of Dolby DE, DD and DD+ bitstreams
- User control of Dolby DE channel config, 16/20 bit, program metadata and frame position at video frame rate
- Control of Dolby DD and DD+ channel config and bit rates
- Choice of audio ramp or fixed tone levels

Optional Toolset [PHRXM-DOLBY]

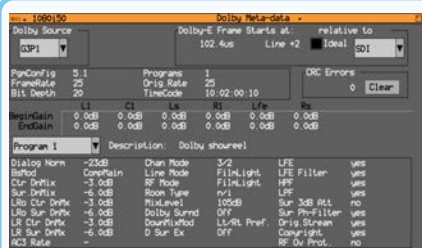

Dolby® Metadata

- Decoding of metadata for Dolby DE, DD and DD+
- Indication of Dolby DE line position – absolute or wrt ideal line
- Indication of CRC errors
- Dolby DD and DD+ Pa spacing and data rate



Dolby® Decoder

- Two independent decoders
- Decode of Dolby DE, DD and DD+
- Creation of LoRo from Dolby DD and DD+ for DownMix monitoring
- Dolby DE program selection for DownMix monitoring

Rx Series Toolsets



ANC Toolset

Optional Toolset [PHRXO-DATA]



ANC Status

- Simple grid layout for rapid visual checking of VANC/ANC ancillary data packets
- Color-coded Packet display: Present, Absent or Fault
- User-definable selections with DID or SDID codes



ANC Inspector

- Ancillary data packet analyzer
- User-definable DID/SDID search editor
- Cursor links to data view, picture and waveform tools
- Freeze and freeze on trigger function



SDI Data View

- Allows analysis of complex faults particularly useful in an R&D environment
- Detailed view of the SDI stream
- Grid, stream views & color coding to help identification
- Linked to waveform, picture and ANC inspector cursors

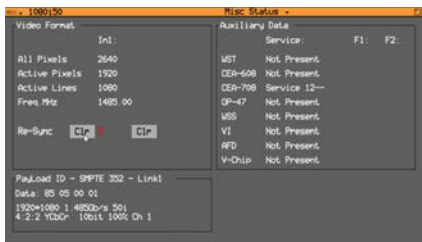

Misc Status

- Detected input video format and SDI framer re-sync indicator
- Signalled input video format – ST 352 Payload ID
- Auxiliary data location/presence indicators

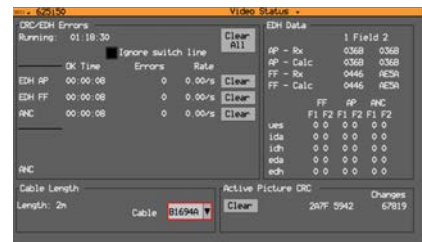

Video Status

- Reporting of CRC, ANC errors and run time
- Switch line handling
- EDH handling (SD)
- Active picture CRC
- Cable length indication, 6 Cable types

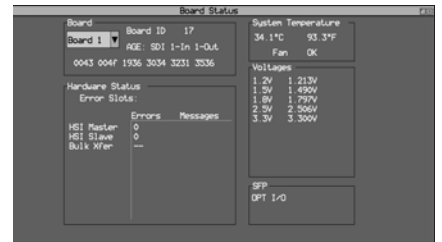

Board Status

- Display of the current status of hardware modules
- Indication of fitted board options
- Indication of fitted SFP
- Check of system temperature, fan status and board supply voltage

Eye & Jitter Toolset

Optional Toolset - [AE & AGE Modules]



SDI Eye Analysis

- RTE™ (Real-Time Eye) technology for SMPTE compliance testing & trouble shooting
- Dual jitter thermometers with selectable filters (10Hz, 100Hz, 1kHz, 10kHz, 100kHz)
- Automatic amplitude, rise/fall time, under/overshoot and cable length measurements
- Amplitude and time histograms
- 1 to 10 eye display
- User-selectable heatmap and persistence controls

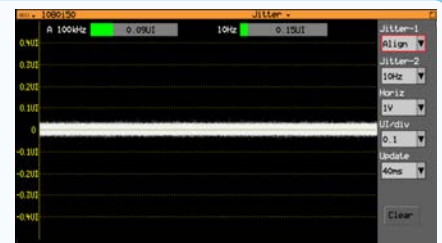
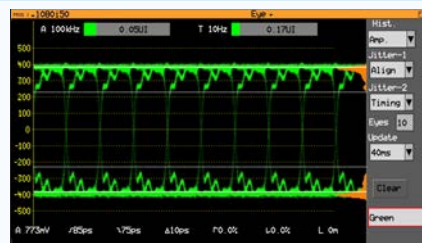

SDI Jitter Analysis

- Realtime SMPTE Jitter measurements down to 10Hz
- 10Hz, 100Hz, 1KHz, 100KHz filters
- 40ms or infinite persistence modes
- H, 2H, V trigger and sweep control
- 0.1, 0.2, 0.5, 1.0 UI/Div vertical gain



Generation Toolset

Optional Toolset - [AG & AGE Modules]

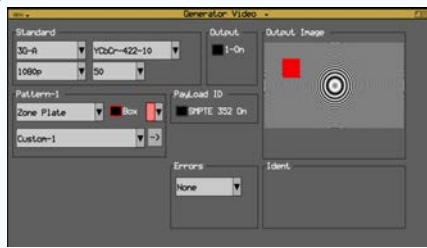

Video Generation

- 2K/3G/HD/SD-SDI signal generation including pathological test patterns for SDI stress testing (40 patterns in total)
- Moving test patterns including zone plate
- Loading of user-defined test patterns
- Ident, ST 352 payload ID and error generation

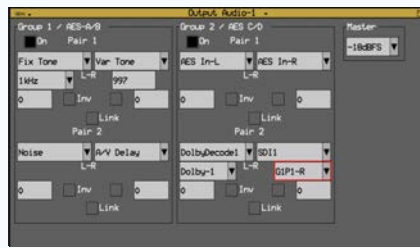

Audio Generation

- Generation of up to 16 channels of audio
- Independent enabling of the 4 audio groups
- Selection of fixed or user-definable tones or audio sources
- Master level control
- Phase inversion per channel



Generator Timing

- User control of the timing of the generator output wrt Reference
- Line and pixel control

Fault Finding & Logging



Screen Capture

- Useful for test documentation and reporting
- Capture of HDMI screen output to BMP
- Rx 2000 capture of right hand front panel LCD screen to BMP



Logging

- Record of detected events for video, audio, AES, Dolby, ANC and eye/Jitter
- Video Events include: input status, EDH/ CRC, TRS and CRC errors
- Audio Events include clip, quiet and mute with level and time thresholds
- Dolby Status includes Dolby DE CRC errors and frame timing outside the 'ideal range'

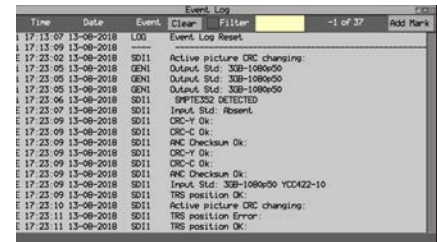

Event Log

- Record of the activation of user-configured triggers
- Trigger event time and date stamp
- User-selectable date stamp mark
- Network Time Protocol (NTP) linked realtime clock

Control Toolset



Remote Browser

- View and control the 1920 x 1080 instrument display over a TCP/IP interface with a standard browser
- Ideal for remote location checking, engineering support, and fault analysis before deploying engineers

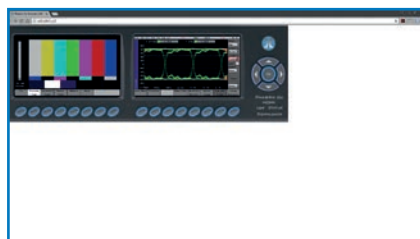

Front Panel Simulation

- Rx2000 also provides a front panel simulator for remote operation via a web browser
- Allows access to key functions including frame capture, screen dumps, loudness files and logging files

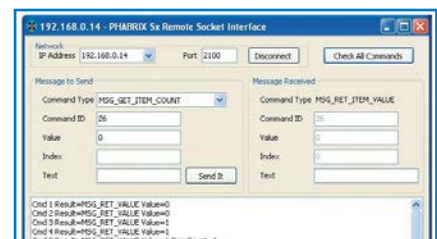

Enhanced Remote Control

- Full control of unit via TCP/IP sockets
- All visual controls have an associated command
- Passive/slave connections

Rx 2000

4 channel analyzer/generator with monitoring via dual built-in screens & speakers

Scalable & flexible design

The top of the range Rx 2000 offers up to 4 channels of 2K/3G/HD/SD-SDI video/audio analysis and monitoring (dual inputs per analyzer), and can also provide signal generation. Up to 16 instruments can be presented simultaneously for video analysis and eye/jitter testing via an external display. Monitoring of the instruments and video can also be performed using dual built-in screens and audio speakers.

The Rx 2000 starter configuration includes a single channel video analyzer, with optional signal generation and eye/jitter analysis. Up to 3 more channels of video analysis/generation, or up to 12x AES audio analysis/generation, can be added with expansion modules.



Ordering

Choice of starter configurations

PHRX2000A	Rx 2000 (2RU) with 1x channel Analyzer module (HD/SD-SDI & embedded audio) <i>Includes Closed Captions, Loudness monitoring and Audio Meters</i>
PHRX2000AE	Rx 2000 (2RU) with 1x channel Analyzer module (HD/SD-SDI & embedded audio) plus Eye/Jitter analysis <i>Includes Closed Captions, Loudness monitoring and Audio Meters</i>
PHRX2000AG	Rx 2000 (2RU) with 1x channel Analyzer/Generator module (HD/SD-SDI & embedded audio) <i>Includes Closed Captions, Loudness monitoring and Audio Meters</i>
PHRX2000AGE	Rx 2000 (2RU) with 1x channel Analyzer/Generator module (HD/SD-SDI & embedded audio) plus Eye/Jitter analysis <i>Includes Closed Captions, Loudness monitoring and Audio Meters</i>

Multi-channel / AES expansion modules (add up to 3 per Rx 2000)

PHRXM-A	1 x Analyzer expansion module (HD/SD-SDI & embedded audio)
PHRXM-AE	1 x Analyzer expansion module (HD/SD-SDI & embedded audio) plus Eye/Jitter analysis
PHRXM-AG	1x Analyzer/Generator expansion module (HD/SD-SDI & embedded audio)
PHRXM-AGE	1 x Analyzer/Generator expansion module (HD/SD-SDI & embedded audio) plus Eye/Jitter analysis
PHRXM-4AES	4 x AES audio analyzer/generator with AES routing expansion module

Options

PHRXO-3G	3G plus advanced formats (422/444, YUV/RGB, 10/12-bit) + 2K-SDI
PHRXM-DOLBY	Dual Dolby® decode, bit stream metadata analyzer and framing indication for Dolby DE, DD and D+
PHRXO-BDA	Dolby® Bitstream analyzer (1 license supports up to 4 input modules)
PHRXO-BDG	Dolby® Bitstream generator (requires generator or AES module)
PHRXO-DATA	SDI data view/ANC packet analyzer
PHRXO-AVD	AV Delay Analysis
PHRXO-GAMUT	Gamut Meters [Only available with A and AG modules]

Accessories

PHRXM-ANA	Analog audio line level output converter
PHSFP-RT30-1310	SFP optical transceiver 3G/HD/SD-SDI - Tx 1310nm, Rx 1260-1620nm
PHSFP-2T30-1310	SFP optical dual transmitter 3G/HD/SD-SDI - Tx 1310nm
PHSFP-2R30	SFP optical dual receiver 3G/HD/SD-SDI - Rx 1260-1620nm
PHSFP-RT30-1550	SFP optical transceiver 3G/HD/SD-SDI - 50km, Tx 1550nm, Rx 1260-1620nm

Warranty

PHRX-3YEAR	3 Year Warranty**
PHRX-5YEAR	5 Year Warranty**

Note: Rx 2000 is a modular solution, and other configurations are available. Please contact PHABRIX Sales for more information.

**One year warranty included as standard

Rx 1000

Compact, 4 channel analyzer/generator & monitoring solution

Scalable, compact design

The advanced Rx 1000 is a compact, 1RU version of the Rx 2000 without the dual built-in monitoring displays or speakers. It provides up to 4 channels of 2K/3G/HD/SD-SDI video/audio analysis and monitoring (dual inputs per analyzer), and also provides signal generation. Up to 16 instruments can be presented simultaneously for video analysis and eye/jitter testing via an external monitor.

The Rx 1000 starter configuration includes a single channel video analyzer, with optional signal generation and eye/jitter analysis. Up to 3 more channels of video analysis/generation, or up to 12x AES audio analysis/generation, can be added with expansion modules.



Ordering

Choice of starter configurations

PHRX1000A	Rx 1000 (1RU) with 1 x channel Analyzer module (HD/SD-SDI & embedded audio) <i>Includes Closed Captions, Loudness monitoring and Audio Meters</i>
PHRX1000AE	Rx 1000 (1RU) with 1 x channel Analyzer module (HD/SD-SDI & embedded audio) plus Eye/Jitter analysis <i>Includes Closed Captions, Loudness monitoring and Audio Meters</i>
PHRX1000AG	Rx 1000 (1RU) with 1 x channel Analyzer/Generator module (HD/SD-SDI & embedded audio) <i>Includes Closed Captions, Loudness monitoring and Audio Meters</i>
PHRX1000AGE	Rx 1000 (1RU) with 1 x channel Analyzer/Generator module (HD/SD-SDI & embedded audio) plus Eye/Jitter analysis <i>Includes Closed Captions, Loudness monitoring and Audio Meters</i>

Multi-channel / AES expansion modules (add up to 3 per Rx 1000)

PHRXM-A	1 x Analyzer expansion module (HD/SD-SDI & embedded audio)
PHRXM-AE	1 x Analyzer expansion module (HD/SD-SDI & embedded audio) plus Eye/Jitter analysis
PHRXM-AG	1x Analyzer/Generator expansion module (HD/SD-SDI & embedded audio)
PHRXM-AGE	1 x Analyzer/Generator expansion module (HD/SD-SDI & embedded audio) plus Eye/Jitter analysis
PHRXM-4AES	4 x AES audio analyzer/generator with AES routing expansion module

Options

PHRXO-3G	3G plus advanced formats (422/444, YUV/RGB, 10/12-bit) + 2K-SDI
PHRXM-DOLBY	Dual Dolby® decode, bit stream metadata analyzer and framing indication for Dolby DE, DD and D+
PHRXO-BDA	Dolby® Bitstream analyzer (1 license supports up to 4 input modules)
PHRXO-BDG	Dolby® Bitstream generator (requires generator or AES module)
PHRXO-DATA	SDI data view/ANC packet analyzer
PHRXO-AVD	AV Delay Analysis
PHRXO-GAMUT	Gamut Meters [Only available with A and AG modules]

Accessories

PHRXM-ANA	Analog audio line level output converter
PHSFP-RT30-1310	SFP optical transceiver 3G/HD/SD-SDI - Tx 1310nm, Rx 1260-1620nm
PHSFP-2T30-1310	SFP optical dual transmitter 3G/HD/SD-SDI - Tx 1310nm
PHSFP-2R30	SFP optical dual receiver 3G/HD/SD-SDI - Rx 1260nm-1620nm
PHSFP-RT30-1550	SFP optical transceiver 3G/HD/SD-SDI - 50km, Tx 1550nm, Rx 1260-1620nm

Warranty

PHRX-3YEAR	3 Year Warranty**
PHRX-5YEAR	5 Year Warranty**

Note: Rx 1000 is a modular solution, and other configurations are available. Please contact PHABRIX Sales for more information.

**One year warranty included as standard

Rx 500

2 channel analyzer/generator & monitoring solution

Expands from single to dual channel

Ideal for Quality Control applications, the Rx 500 is a single/dual channel 2K/3G/HD/SD-SDI video/audio analyzer and monitoring solution in a very compact 1/2 RU frame (dual inputs per analyzer). It supports dual inputs per analyzer and can also provide signal generation for video and audio. Up to 16 instruments can be presented simultaneously for video analysis and eye/jitter testing.

The Rx 500 starter configuration includes a single channel video analyzer, with optional signal generation and eye/jitter analysis.



Ordering

Choice of starter configurations

PHRX500A	Rx 500 (1/2 1RU) with 1 x channel Analyzer module (HD/SD-SDI & embedded audio) <i>Includes Closed Captions, Loudness monitoring and Audio Meters</i>
PHRX500AE	Rx 500 (1/2 1RU) with 1 x channel Analyzer module (HD/SD-SDI & embedded audio) plus Eye/Jitter analysis <i>Includes Closed Captions, Loudness monitoring and Audio Meters</i>
PHRX500AG	Rx 500 (1/2 1RU) with 1 x channel Analyzer/Generator module (HD/SD-SDI & embedded audio) <i>Includes Closed Captions, Loudness monitoring and Audio Meters</i>
PHRX500AGE	Rx 500 (1/2 1RU) with 1 x channel Analyzer/Generator module (HD/SD-SDI & embedded audio) <i>Plus Eye/Jitter analysis</i> <i>Includes Closed Captions, Loudness monitoring and Audio Meters</i>

Channel #2 / AES expansion modules (add 1 per Rx 500)

PHRXM-A	1 x Analyzer expansion module (HD/SD-SDI & embedded audio)
PHRXM-AG	1x Analyzer/Generator expansion module (HD/SD-SDI & embedded audio)
PHRXM-4AES	4 x AES audio analyzer/generator with AES routing expansion module

Options

PHRXO-3G	3G plus advanced formats (422/444, YUV/RGB, 10/12-bit) + 2K-SDI
PHRXM-DOLBY	Dual Dolby® decode, bit stream metadata analyzer and framing indication for Dolby DE, DD and D+
PHRXM-BDA	Dolby® Bitstream analyzer (1 license supports up to 4 input modules)
PHRXO-BDG	Dolby® Bitstream generator (requires generator or AES module)
PHRXO-DATA	SDI data view/ANC packet analyzer
PHRXO-AVD	AV Delay Analysis
PHRXO-GAMUT	Gamut Meters [Only available with A and AG modules]

Accessories

PHRXM-ANA	Analog audio line level output converter
PHSFP-RT30-1310	SFP optical transceiver 3G/HD/SD-SDI - Tx 1310nm, Rx 1260-1620nm
PHSFP-2T30-1310	SFP optical dual transmitter 3G/HD/SD-SDI - Tx 1310nm
PHSFP-2R30	SFP optical dual receiver 3G/HD/SD-SDI - Rx 1260-1620nm
PHSFP-RT30-1550	SFP optical transceiver 3G/HD/SD-SDI - 50km, Tx 1550nm, Rx 1260-1620nm
PHRXK1	19" rack mount fitting kit for 1 x Rx 500
PHRXK2	19" rack mount fitting kit for 2 x Rx 500
PHRXK5	Desktop Kit with adjustable feet and handles

Warranty

PHRX-3YEAR	3 Year Warranty**
PHRX-5YEAR	5 Year Warranty**

Note: Rx 500 is a modular solution, and other configurations are available. Please contact PHABRIX Sales for more information.

**One year warranty included as standard

Hardware Modules



SFP

PHRXM-A Dual input 3G/HD/SD SDI single analyzer

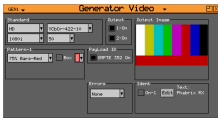

SFP

PHRXM-AG Single input 3G/HD/SD SDI single analyzer plus SDI generator

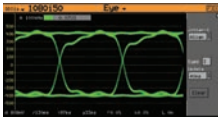

SFP

PHRXM-AE Dual input 3G/HD/SD SDI single analyzer with eye and jitter

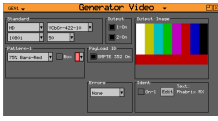

SFP

PHRXM-AGE Single input 3G/HD/SD SDI single analyzer with eye and jitter plus SDI generator

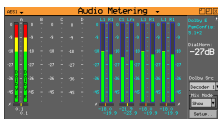

Speaker icon

PHRXM-4 AES Audio I/O 75 Ohm unbalanced



Speaker icon

DOLBY AUDIO™

PHRXM-DOLBY Dual Dolby decoder Dolby E/D/D Plus (mounted on CPU card)

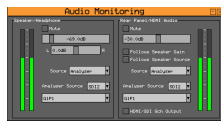
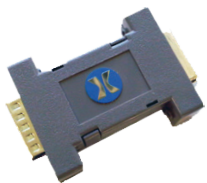

Speaker icon

PHRXM-ANA Analog audio line level output converter

Specifications

● Standard

○ Optional

Description	Rx 500	Rx 1000	Rx 2000
SD-SDI, HD-SDI as standard	●	●	●
Optional 3G-SDI (license)	○	○	○
Dual 16:9, 24 bit, 4.3" TFT, 480 x 272 pixels	N/A	N/A	●
OLED display	●	●	N/A
Front panel backlit navigation keypad	●	●	●
Front panel volume/gain control	●	●	●
Front panel headphone connector 6.3mm (1/4 inch) Stereo jack	●	●	●
Front panel USB 2.0 host port type A socket + 2 rear panel USB 2.0 ports	●	●	●
Internal loudspeaker	Beeper	Beeper	2 x 7w wide range
I/O Module slots (each supporting a range of audio/video modules)	2	4	4
Internal Dual Dolby® decoder module slot (option)	1	1	1
HDMI instrument output, 1920 x 1080, 4:4:4 RGB, Type A	●	●	●
SDI instrument output, 1920 x 1080, 4:2:2 YUV, BNC 75 Ohm	●	●	●
Basic SDI generator included as standard (replaces instrument output)	●	●	●
8 channel 48kHz PCM audio on HDMI and SDI Instrument outputs	●	●	●
Reference/VITC input, passive loop through, BNC 75 Ohm compensated	●	●	●
AES input AES 3-ID, SMPTE 276M-1995, 75 Ohm BNC	●	●	●
LTC input (via 26 pin high density 'D' Type socket)	●	●	●
8x GPI I/O (via 26 pin high density 'D' Type socket)	●	●	●
Stereo analog audio output, (via 26 pin high density 'D' Type socket)	●	●	●
Calibrated stereo balanced analog audio output (option module)	●	●	●
Ethernet remote control via browser, RJ45 connector, 10/100Base-T	●	●	●
IP sockets based remote control as standard	●	●	●
FPGA firmware/software upgrade via Ethernet/USB	●	●	●
Viewing angle tilt mechanism	N/A	N/A	●
Desktop mounting kit	●	●	N/A
19" Rack-mount kit	1U (options)	1U (standard)	2U (standard)
10.5"/9.5" Rack-mount	○	N/A	N/A
Whisper quiet temperature controlled fan	1 x 40mm internal	2 x 40mm external	1 x 60mm external
Power consumption (variable on modules inserted)	24W typical 40W max	24W typical 70W max	27W typical 80W max
4 Pin XLR power connector, 12V nominal (9V-18V)	●	●	●
AC Power adaptor (included), 90-264VAC, 120W	●	●	●
Dimensions (width x height x depth) excluding ears & projections	210 x 44 x 170mm	440 x 44 x 170mm	440 x 88 x 150mm
Weight (chassis with CPU module and 1x AG option module fitted)	1.3 kg	2.0 kg	2.3 kg
1 year manufacturers warranty - 3 & 5 year warranty options available	●	●	●

Formats supported

SMPT E Standards Link (Content)	Interface	Resolution	Sampling Structure	Pixel Depth	Frame/Field Rate	Rx
ST 259 (ST 125)	SD (625i)	720 x 576	4:2:2 (YCbCr)	10	50i	●
ST 259 (ST 125)	SD (625i)	720 x 485	4:2:2 (YCbCr)	10	59.94i	●
ST 292 (ST 296)	HD	1280 x 720	4:2:2 (YCbCr)	10	60p, 59.94p, 50p, 30p, 29.97 25, 24p, 23.98p	●
ST 292 (ST 260)	HD	1920 x 1035	4:2:2 (YCbCr)	10	60i, 59.94i	●
ST 292 (ST 274)	HD	1920 x 1080	4:2:2 (YCbCr)	10	60i, 59.94i, 50i	●
ST 292 (ST 274)	HD	1920 x 1080	4:2:2 (YCbCr)	10	30p, 29.97p, 25p, 24p, 23.98p	●
ST 292 (RP 211)	HD	1920 x 1080	4:2:2 (YCbCr)	10	30psF, 29.97psF, 25pSF, 24psF, 23.98psF	●
ST 292 (ST 2048-2)	HD	2048 x 1080	4:2:2 (YCbCr)	10	30p, 29.97p, 25p, 24p, 23.98p	●
ST 372 (ST 274)	Dual Link HD	1920 x 1080	4:2:2 (YCbCr)	10	60p, 59.94p, 50p	○
ST 372 (ST 274)	Dual Link HD	1920 x 1080	4:4:4 (YCbCr/RGB) 4:4:4:4 (YCbCrA/RGBA)	10	60i, 59.94i, 50i, 30psF, 29.97psF, 25pSF, 24psF, 23.98psF 30p, 29.97p, 25p, 24p, 23.98p	○
ST 372 (ST 274)	Dual Link HD	1920 x 1080	4:4:4 (YCbCr/RGB)	12	60i, 59.94i, 50i, 30psF, 29.97psF, 25pSF, 24psF, 23.98psF 30p, 29.97p, 25p, 24p, 23.98p	○
ST 372 (ST 274)	Dual Link HD	1920 x 1080	4:2:2 (YCbCr) 4:2:2:4 (YCbCrA)	12	60i, 59.94i, 50i, 30psF, 29.97psF, 25pSF, 24psF, 23.98psF 30p, 29.97p, 25p, 24p, 23.98p	○
ST 372 (ST 2048-2)	Dual Link HD	2048 x 1080	4:2:2 (YCbCr)	10	60p, 59.94p, 50p, 48p, 47.95p	○
ST 372 (ST 2048-2)	Dual Link HD	2048 x 1080	4:4:4 (YCbCr) 4:4:4:4 (YCbCrA/RGBA)	10	30psF, 29.97psF, 25pSF, 24psF, 23.98psF, 30p, 29.97p, 25p, 24p, 23.98p	○
ST 372 (ST 2048-2)	Dual Link HD	2048 x 1080	4:4:4 (YCbCr/RGB)	12	30psF, 29.97psF, 25pSF, 24psF, 23.98psF, 30p, 29.97p, 25p, 24p, 23.98p	○
ST 372 (ST 2048-2)	Dual Link HD	2048 x 1080	4:2:2 (YCbCr) 4:2:2:4 (YCbCrA)	12	30psF, 29.97psF, 25pSF, 24psF, 23.98psF, 30p, 29.97psF, 25p, 24p, 23.98p	○
ST 425-1 (ST 274)	3G Level A (1)	1920 x 1080	4:2:2 (YCbCr)	10	60p, 59.94p, 50p	○
ST 425-1 (ST 2048-2)	3G Level A (1)	2048 x 1080	4:2:2 (YCbCr)	10	60p, 59.94p, 50p, 48p, 47.95p	○
ST 425-1 (ST 296)	3G Level A (2)	1280 x 720	4:4:4 (YCbCr/RGB) 4:4:4:4 (YCbCrA/RGBA)	10	60p, 59.94p, 50p, 30p, 29.97p, 25p, 24p, 23.98p	○
ST 425-1 (ST 274)	3G Level A (2)	1920 x 1080	4:4:4 (YCbCr/RGB) 4:4:4:4 (YCbCrA/RGBA)	10	60i, 59.94i, 50i, 30psF, 29.97psF, 25pSF, 24psF, 23.98psF 30p, 29.97p, 25p, 24p, 23.98p	○
ST 425-1 (ST 2048-2)	3G Level A (2)	2048 x 1080	4:4:4 (YCbCr/RGB) 4:4:4:4 (YCbCrA/RGBA)	10	30psF, 29.97psF, 25pSF, 24psF, 23.98psF, 30p, 29.97p, 25p, 24p, 23.98p	○
ST 425-1 (ST 274)	3G Level A (3)	1920 x 1080	4:4:4 (YCbCr/RGB)	12	60i, 59.94i, 50i, 30p, 29.97p, 25p, 24p, 23.98p	○
ST 425-1 (ST 2048-2)	3G Level A (3)	2048 x 1080	4:4:4 (YCbCr/RGB)	12	30psF, 29.97psF, 25pSF, 24psF, 23.98psF, 30p, 29.97p, 25p, 24p, 23.98p	○
ST 425-1 (ST 274)	3G Level A (4)	1920 x 1080	4:2:2 (YCbCr)	12	60i, 59.94i, 50i, 30psF, 29.97psF, 25pSF, 24psF, 23.98psF 30p, 29.97p, 25p, 24p, 23.98p	○
ST 425-1 (ST 2048-2)	3G Level A (4)	2048 x 1080	4:2:2 (YCbCr) 4:2:2:4 (YCbCrA)	12	30psF, 29.97psF, 25pSF, 24psF, 23.98psF, 30p, 29.97p, 25p, 24p, 23.98p	○
ST 425-1 (ST 274)	3G Level B-DL (I)	1920 x 1080	4:2:2 (YCbCr)	10	60p, 59.94p, 50p	○
ST 425-1 (ST 2048-2)	3G Level B-DL (I)	2048 x 1080	4:2:2 (YCbCr)	10	60p, 59.94p, 50p, 48p, 47.95p	○
ST 425-1 (ST 274)	3G Level B-DL (II)	1920 x 1080	4:4:4 (YCbCr/RGB) 4:4:4:4 (YCbCr/RGBA)	10	60i, 59.94i, 50i, 30psF, 29.97psF, 25pSF, 24psF, 23.98psF 30p, 29.97p, 25p, 24p, 23.98psF	○
St 425-1 (ST 2048-2)	3G Level B-DL (II)	2048 x 1080	4:4:4 (YCbCr/RGB) 4:4:4:4 (YCbCr/RGBA)	10	30psF, 29.97psF, 25psF, 24psF, 23.98psF, 30p, 29.97p, 25p, 24p, 23.98p	○
ST 425-1 (ST 274)	3G Level B-DL (III)	1920 x 1080	4:4:4 (YCbCr/RGB)	12	60i, 59.94i, 50i, 30p, 29.97p, 25p, 24p, 23.98p	○
ST 425-1 (ST 2048-2)	3G Level B-DL (III)	2048 x 1080	4:4:4 (YCbCr/RGB)	12	30psF, 29.97psF, 25psF, 24psF, 23.98psF, 30p, 29.97p, 25p, 24p, 23.98p	○
ST 425-1 (ST 274)	3G Level B-DL (IV)	1920 x 1080	4:2:2 (YCbCr)	12	60i, 59.94i, 50i, 30psF, 29.97psF, 25psF, 24psF, 23.98psF, 30p, 29.97p, 25p, 24p, 23.98p	○
ST 425-1 (ST 2048-2)	3G Level B-DL (IV)	2048 x 1080	4:2:2 (YCbCr) 4:2:2:4 (YCbCrA)	12	30psF, 29.97psF, 25psF, 24psF, 23.98psF, 30p, 29.97p, 25p, 24p, 23.98p	○
ST 425-1 (ST 296)	3G Level D-DS	2x (1280 x 720)	4:2:2 (YCbCr)	10	60p, 59.94p, 50p, 30p, 29.97p, 25p, 24p, 23.98p	●
ST 425-1 (ST 274)	3G Level B-DS	2x (1920 x 1080)	4:2:2 (YCbCr)	10	60i, 59.94i, 50i, 30psF, 29.97psF, 25psF, 24psF, 23.98psF, 30p, 29.97p, 25p, 24p, 23.98p	●
ST 425-1 (ST 2048-2)	3G Level B-DS	2x (2048 x 1080)	4:2:2 (YCbCr)	10	60i, 59.94i, 50i, 30psF, 29.97psF, 25psF, 24psF, 23.98psF, 30p, 29.97p, 25p, 24p, 23.98p	●

Dimensions & installation

Rx 2000

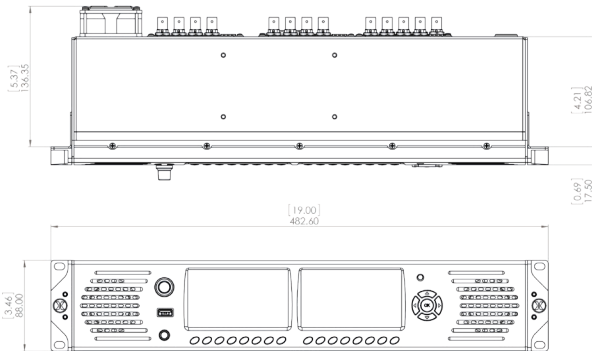

Rx 1000

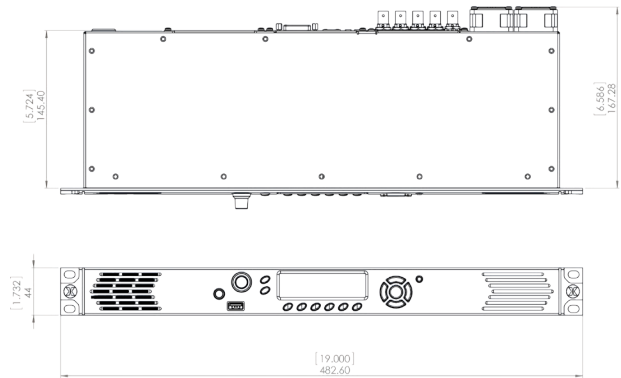

Rx 500

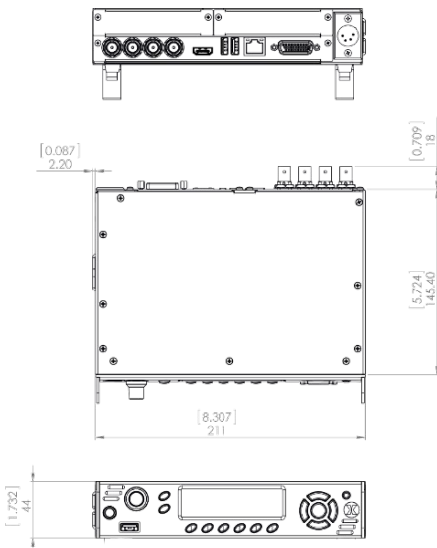

Single Rx 500 rack mount tray with cover (PHRXK1)



Dual Rx 500 rack mount (PHRXK2)



PHABRIX[®]
A Leader Company

Leader

For more information about the Rx Series of
analyzers/generators, contact:

www.leaderphabrix.com



PHABRIX products are continuously being updated.
Please visit www.phabrix.com for latest product information
July 2024